



## CONVERSION KIT

## INSTALLATION MANUAL

FOR ALL CABINET STYLES OF CRUIS'N USA™,  
CRUIS'N WORLD™ AND OFFROAD CHALLENGE™  
VIDEO GAMES

### MANUAL INCLUDES

INSTALLATION \* OPERATION \* ADJUSTMENTS \* TROUBLESHOOTING

The manufacturer intends that this game is to be operated for amusement purposes only and not in contravention of any federal, state or local law or regulation of the United States or any foreign country governing gaming devices. All operators of this game are responsible for its operation in accordance with such laws and regulations. The manufacturer's factory settings for this game may require adjustment in order to comply with laws applicable in an operator's specific jurisdiction. It is the operator's responsibility to determine whether adjustments are necessary and, if they are, to make the appropriate adjustments prior to operating the amusement game.

MIDWAY AMUSEMENT GAMES, LLC  
3401 NORTH CALIFORNIA AVENUE CHICAGO, ILLINOIS 60618 USA  
<http://www.midwaygames.com>





## CHAPTER ONE

# INSTALLATION & OPERATION









**NOTICE:** Information in this manual may change without notice. Midway Amusement Games, LLC reserves the right to make improvements in equipment function, design, or components as progress in engineering or manufacturing methods may warrant.



## SAFETY INSTRUCTIONS

The following safety instructions apply to operators and service personnel. Read these instructions before servicing or preparing the Video Game Machine (VGM) for play. Other safety instructions appear throughout this manual.

### DEFINITIONS OF SAFETY TERMS

- **DANGER** indicates an imminent hazard. If you fail to avoid this hazard, it **WILL** cause death or serious injury.
- **WARNING** indicates a potential hazard. If you fail to avoid this hazard, it **COULD** cause death or serious injury.
- **CAUTION** indicates a potential hazard. If you fail to avoid this hazard, it **MAY** cause minor or moderate injury. **CAUTION** also alerts you about unsafe practices.
- **NOTE** indicates information of special importance.

	<p><b>WARNING: TRANSPORTING GAMES.</b> The VGM contains glass and fragile electronic devices. Use appropriate care when transporting. Avoid rough handling when moving the cabinet. Do not move with the power switched on.</p>
	<p><b>WARNING: DISCONNECT POWER.</b> Always turn the power OFF and unplug the VGM before attempting service or adjustments unless otherwise instructed. Installing or repairing boards with power switched on can damage components and void the warranty.</p>
	<p><b>WARNING: GROUND GAMES.</b> Avoid electrical shocks! Do not plug in a VGM until you have inspected and properly grounded it. Only plug this game into a grounded, three-wire outlet. Do not use a "cheater" plug, or cut off the ground pin on the line cord.</p>
	<p><b>WARNING: AVOID ELECTRICAL SHOCKS.</b> The VGM system does not utilize an isolation transformer. Internal cabinet AC is not isolated from the external AC line.</p>
	<p><b>WARNING: HANDLE FLUORESCENT TUBE AND CRT WITH CARE.</b> If you drop a fluorescent tube or CRT and it breaks, it will implode! Shattered glass can fly eight feet or more from the implosion.</p>
	<p><b>CAUTION: CHECK POWER SELECTOR, LAMP.</b> Set the 115/230VAC selector on the power supply for the correct line voltage. Check the selector setting before switching on the VGM. Verify that the fluorescent lamp assembly is correct for the local line voltage.</p>
	<p><b>CAUTION: USE PROPER FUSE.</b> Avoid electrical shock! Replacement fuses must be identically rated. Fuse voltage and current ratings must be identically rated to the original fuse.</p>

	<p><b>CAUTION: ATTACH CONNECTORS PROPERLY.</b> Be sure board connectors mate properly. If connectors do not slip on easily, do not force them. A reversed connector may damage the VGM and void the warranty. Connector keys only allow a connector to fit one set of pins on a board.</p>
	<p><b>CAUTION: USE CARE WHEN SHIPPING HARD DISKS.</b> The hard disk drive must be packed in an anti-static bag. When shipping the drive for repair or replacement, pack it in an approved container (P/N 08-8068). Do not stack or drop hard disk drives.</p>
	<p><b>WARNING: HAZARD TO EPILEPTICS.</b> A very small portion of the population has a condition which may cause them to experience epileptic seizures or have momentary loss of consciousness when viewing certain kinds of flashing lights or patterns that are present in our daily environment. These persons may experience seizures while watching some kinds of television pictures or playing certain video games. People who have not had any previous seizures may nonetheless have an undetected epileptic condition.</p> <p>If you or anyone in your family has experienced symptoms linked to an epileptic condition (e.g., seizures or loss of awareness), immediately consult your physician before using any video games.</p> <p>We recommend that parents observe their children while they play video games. If you or your child experience the following symptoms: dizziness, altered vision, eye or muscle twitching, involuntary movements, loss of awareness, disorientation, or convulsions, <b>DISCONTINUE USE IMMEDIATELY</b> and consult your physician.</p>



**NOTICE:** This manual contains only information related to the CPU Board and game features for *Cruis'n Exotica™*. Refer to the original Operator's Manual for the game machine being converted for specific service, parts and wiring information.

## INSPECT KIT 44072

Kit 44072 contains artwork, a CPU Board assembly, PLD assemblies and the cables necessary to convert all cabinet styles (except motion games) of *Cruis'n USA™*, *Cruis'n World™* and *OffRoad Challenge™* into *Cruis'n Exotica™*.

Unpack the materials from the carton and check for obvious signs of damage. Use this checklist to be sure the kit is complete. **NOTE:** Thoroughly read and understand instructions prior to performing a conversion.

Item	Part Number	Qty.	Item	Part Number	Qty.
<b>CABLES</b>			<b>ARTWORK</b>		
Cable, Conversion kit	H-23699	1	Decal, Side, Right & Left	31-3601	2
Cable, Sound Adapter	H-23700	1	Marquee, Center	31-3600	1
Cable, Linking, 16ft.	20-10536-16	1	<b>BOARD ASSEMBLIES</b>		
<b>MISCELLANEOUS</b>			CPU Board	A-22536-2	1
IC PLCC Extractor	20-9924	1	PLD Assembly, U8	41-00001	1
---	---	---	PLD Assembly, U3	41-00002	1

## PREPARE GAME CABINET FOR CONVERSION

1. Verify operation of existing game machine prior to performing conversion. Pay special attention to components that will be reused once conversion is complete. Check power supply, video monitor, currency acceptors, wiring harnesses, cabinet locks, and lighted marquee, etc.
2. Prepare cabinet for artwork.

•**Cruis'n USA™** and **Cruis'n World™** game machines being converted need only be wiped down with a clean cloth. Spray a mild cleanser directly on a cloth-- never spray a cleansing product directly on game cabinet or any other components-- and wipe clean.

•**OffRoad Challenge™** game machines being converted require removal of old decals and any artwork from game cabinet. First, clean off any glue residue, then fill gouges or unused holes with quick-hardening wood putty and sand until smooth. Remove any dust and then evenly cover cabinet with black paint and allow to dry completely prior to continuing.

## INSTALL NEW HARDWARE

3. Switch off power to game cabinet and unplug from outlet. Unlock and remove the rear cabinet door.
4. Remove perforated metal enclosure located over CPU Board assembly. Discard enclosure, as it will not be reused with new board assembly.
5. Label and disconnect all wiring connected to CPU Board.
6. Remove hex head screws used to fasten CPU Board assembly to electronics rack. Lift board from rack, careful not to let the PCB standoffs fall into cabinet, and place it in an anti-static bag. Set screws and standoffs aside for reuse later.

7. Prepare CPU Board for installation. Remove *Cruis'n Exotica™* CPU Board from its anti-static packaging. Verify and set DIP Switch settings prior to installing CPU Board to ensure proper operation.

•**Cruis'n USA™** and **Cruis'n World™** games being converted require Switch 1 on DIP Switch 1 be in the ON position. Switch 4 on DIP Switch 1 must be in the OFF position. Refer to *Setting Table for DIP Switch 1* located in *Section Two: Adjustment, Diagnostic & Audit Menus* for further information.

•**OffRoad Challenge™** games being converted require Switch 1 on DIP Switch 1 be in the ON position. Switch 4 on DIP Switch 1 must be in the ON position. Refer to *Setting Table for DIP Switch 1* located in *Section Two: Adjustment, Diagnostic & Audit Menus* for further information.

8. Place *Cruis'n Exotica™* CPU Board in same position on electronics rack as the old CPU Board and fasten in place reusing original screws and standoffs. During installation, be careful not to let the PCB standoffs fall into the cabinet
9. Reattach cabling and wiring onto new CPU Board. Please note that not all of the preexisting cabling will be reconnected onto the new CPU Board.
10. Connect Conversion Kit Adapter Cable, labeled H-23699, to main harness. Attach Z-header located at the end of this cable to harness --previously attached to P9-- and the opposite end to PLAYER 3 on CPU Board.
11. Connect Sound Adapter Cable, labeled H-23700. Attach Z-header located at the end of this cable to the pre-existing Sound Cable --previously attached to P3 on the old CPU-- and the opposite end to P18 on new CPU Board.
12. **Cruis'n USA™ game conversions only:** Connect Auxiliary Power Connector, the second cable attached to Sound Adapter Cable, which was previously connected to P5. Attach Z-header located at end of this cable to the pre-existing cable, and the opposite end to P22 on the CPU Board.
13. Attach A2D connection to P11 on the new CPU Board. This connection was previously attached to P8.
14. Remove cable for AC Power to Sound from P4 on the CPU Board. **NOTE:** DO NOT reconnect this cable. This connection is not reused.
15. Install PLD assembly on Wheel Driver Board. Locate appropriate assembly by first identifying the game being converted and follow the steps outlined below.

•**Cruis'n USA™** games being converted use PLD assembly 41-00001. Remove old PLD assembly from location U8 on wheel driver board using the PLCC extractor supplied in the kit to aid in removal of this part. Properly orient new PLD assembly over socket and press firmly to seat.

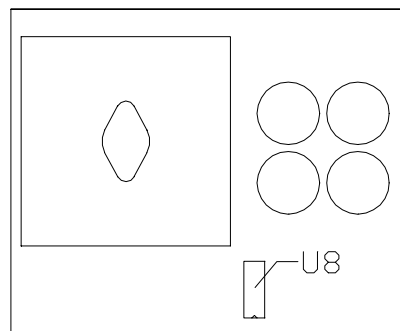

**Cruis'n USA™ WHEEL DRIVER**

•**Cruis'n World™** and **OffRoad Challenge™** games being converted use PLD assembly 41-00002. Remove old PLD assembly from location U3 on the wheel driver board, using a slight rocking motion. Properly orient the new PLD assembly over socket and press firmly to seat.

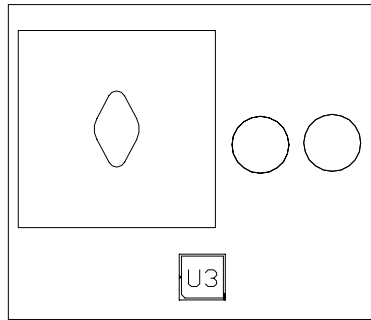

**Cruis'n World™ & OffRoad Challenge™ WHEEL DRIVER BOARD**

**UPDATE ARTWORK**

16. Apply cabinet decals. Remove backing and apply decal(s) to cabinet, smoothing it out as you go.
17. Replace marquee artwork. Remove hex head screws used to fasten retaining bracket along top edge of cabinet marquee. Set screws and retaining strip aside for reuse later.
18. Carefully lift out marquee artwork and/or marquee glass. Determine cabinet size for your marquee and cut *Cruis'n Exotica™* marquee artwork to size. **NOTE:** Cutting guidelines are provided for your convenience and appear directly on the marquee artwork. Be sure to compare the size of the original artwork to the cutting guideline on the *Cruis'n Exotica™* artwork prior to cutting.
19. Install marquee artwork, as well as marquee glass if it was removed. Replace retaining strip above marquee and fasten in place.

**ENABLE LINKING (Optional)**

20. Install new linking cable. Remove and discard pre-existing linking cable.
21. Starting with game cabinet designated *Game 1*, which is always located on the far left hand side, attach one end of the new linking cable to P12 on game electronics.
22. Route remaining free end of cable through notch located in the rear door opening and extend it toward desired game cabinet.
23. Attach free end of linking cable to P14 on game electronics inside game cabinet to be designated as *Game 2*.
24. Check DIP Switch is properly set to enable linking. Switch 6 on DIP Switch 1 must be in the ON position. Refer to *Setting Table for DIP Switch 1* located in *Chapter Two: Adjustment, Diagnostic & Audit Menus* for further information.

FUNCTION	SW1	SW2	SW3	SW4	SW5	SW6	SW7	SW8
LINK DISABLED						OFF		
LINK ENABLED						ON		
LINKING ID NUMBER								
MASTER (GAME NUMBER 1)							OFF	OFF
SLAVE (GAME NUMBER 2)							ON	OFF
SLAVE (GAME NUMBER 3)							OFF	ON
SLAVE (GAME NUMBER 4)							ON	ON



## TEST GAME

25. Plug power cord into AC line and switch on power to cabinet. Observe circuit board indicators light-up.
26. The game system loads program and automatically enters self-diagnostics. The system will automatically enter Attract Mode if no errors are found during self-diagnostics. Check wiring if problems occur and troubleshoot system if necessary.
27. Open coin door. Locate operator control switch panel and then press and hold the Begin Test button to enter menu system. Wait until the Main Menu screen appears on monitor.
28. Follow on-screen instructions to select Diagnostics, then choose SWITCH TEST. Follow on-screen instructions to verify that each of the controls is operational. If no errors are found, the controls will function well.
29. Return to Diagnostics screen, and then choose SOUND BOARD TEST. Follow on-screen instructions to verify that each of the speakers is operational. If no errors are found, the audio will function well.
30. Return to Diagnostics screen, and then choose STEERING WHEEL TEST. Follow on-screen instructions to verify presence of steering resistance.
31. Return to Main Menu screen, then choose CALIBRATE CONTROLS. Follow on-screen instructions to set steering limits. If no errors are found, controls will have the maximum accuracy.
32. Return to Diagnostics screen, and then choose LINKING TEST. Follow on-screen instructions to verify communications between game machine and another connected to it. If no errors are found, linking mode will function well.
33. Return to Main Menu screen, and then choose EXIT. The game will automatically enter its “attract” mode of operation (scenes and sounds from typical races, player’s scores, messages, etc.).
34. Insert currency or tokens and play a game. Change the volume and make any other adjustments. Close and lock all open doors. Tighten leveler nuts and engage caster locks. Replace and lock rear cabinet door.



**CAUTION:** You are solely responsible, and Midway has no responsibility for FCC compliance of installed kits. Do not install a FCC compliance label on the product until compliance is verified.

## GAME FEATURES

*CRUIS’N EXOTICA™ ships configured for one-player game play. Cabinets may be linked to permit player competition.*

*Cruis’n Exotica™ is the latest, most thrilling and adventurous driving game in the Cruis’n™ video game series. Players can select tracks located in nearly a dozen exotic locales around the globe. From Tibet to Atlantis, Mars to Hong Kong, it is every player’s goal to accumulate a high score and mileage points.*

*Speeding on their way toward a first place finish, drivers listen to cool tunes on the radio as they pass palms swaying in the breeze, 3-Dimensional animals cavorting roadside, and a variety of shortcuts hidden along the way. A player’s combined speed and skill virtually assure a place in the winner’s circle.*

*Player incentives, like free games for top speeds and distance, are sure to captivate players and ensure many trips around the track. And players finishing in first place will soon discover they have been whisked away on a free trip to an exotic locale. (Player incentives are Operator Optional and are enabled only at the Operator’s discretion)*

## STARTING UP

Each time power is switched on or restored to the game machine, the system enters Start-up Tests. Observe the screen displays a CPU Board map. Bad ICs are indicated in red, good ICs are in green. The software revision level is shown at the top of the screen.

A status screen to report on network activity will appear for about ten seconds. This screen is used to verify and troubleshoot connections on an array of cabinets.

The system enters Attract Mode once it passes all power-up tests. The Attract Mode screen will cycle endlessly and display a variety of scenes and sounds from a typical race on any given track. The system does not exit Attract Mode until the desired amount of coins or tokens is inserted and game play commences.

**NOTE:** An error message appears on screen and the game does not enter start up if an error is detected during the Start-Up Test. Record any messages before attempting to service game.

## GAME RULES AND OBJECTIVES

The game is configured for one-player game play, but up to four cabinets may be linked at one time to promote multiple player competition.

To enter Game Mode, individual player(s) must insert required amount of currency or tokens, press the Start button, and select a car and track. The main objective of the game is to earn top ranking against other drivers.

## PLAYER CONTROLS

- Green Start button  
The start button is used to begin game play or to select certain features before a race.
- Orange Radio button  
The radio button allows the player to turn radio sounds on and off, and to change stations.
- Red button  
This button shows the view from the driver's seat inside the vehicle. This is a normal driver view.
- White button  
This button shows the view from directly behind. The player can see the rear end of the vehicle.
- Blue button  
This button shows an aerial view of the vehicle. This is what a helicopter camera would see.
- Pedals  
The gas and brake pedals control vehicle speed. Press the gas pedal twice to create a power boost.  
**NOTE:** Upright cabinet styles are not equipped with a brake pedal.
- Seat Position Adjuster  
The seat position may be changed at any time, even during competition. Pull the adjustment lever to the left while seated then slide the seat forward or backward. Release the lever to lock the seat into position.

## GAME OPERATION

Access to the menu system for statistics, adjustments, and testing is secured by a keyed lock to prevent tampering. When the menu system is entered, on screen messages guide the operator through tasks.

### Cabinet Switches

- The **ON/OFF SWITCH** is located on the topside of the cabinet.

- The **REMOTE MONITOR ADJUSTMENTS** are located inside coin vault. Adjust video image size, brightness, contrast, etc., using the Monitor Test screens and the monitor controls.
- The **SLAM TILT SWITCH** detects forceful vibrations against coin door to eliminate pounding for free games. It is located on the inside of the coin door opening near the lock.  
**NOTE:** The Slam switch is not present on Dollar Bill Validator (DBV) ready doors.

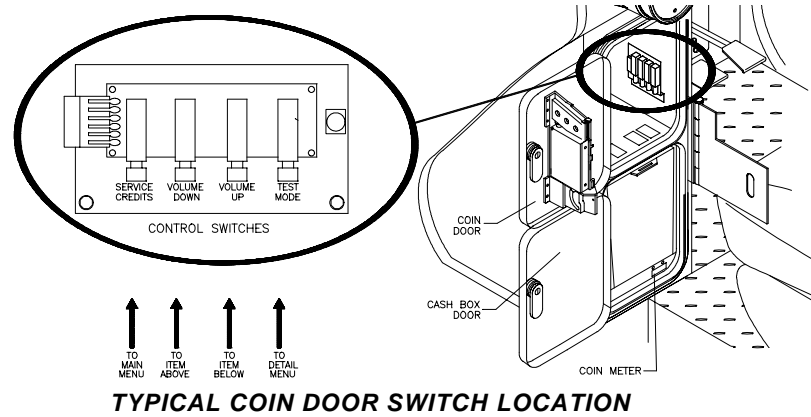

### Control Buttons

- The **TEST BUTTON** accesses the game Menu System. Press the Test button to access the Main Menu and select individual diagnostics, audits, utilities, etc.
- The **VOLUME UP BUTTON** scrolls through menu selections or adjustment items and raises the sound level in game play. An audible tone accompanies activation of this button.
- The **VOLUME DOWN BUTTON** scrolls through the menu selections or adjustment items and lowers the sound level in game play. An audible tone accompanies activation of this button.
- The **SERVICE CREDIT BUTTON** allots credits without affecting the game's bookkeeping total. This button can also be used to exit from menu selections or to return to the main menu.

### CPU BOARD ASSEMBLY A-22536-2

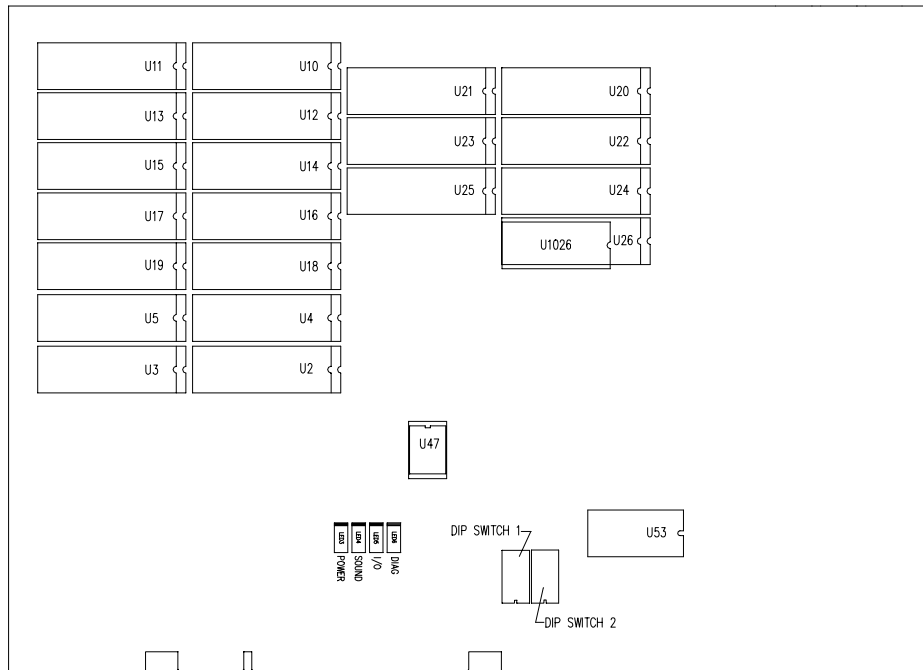

Designation	Part Number	Function	Description
U47	5460-15676-00	Config Memory Backup	3V Lithium Battery
F1, F2	5735-13853-00	Circuit Protection	2A SB Fuse 5x20mm
U2	A-5343-40072-11	Sound	EPROM Assembly
U3	5341-16431-14	Sound	EPROM Assembly
U4	5341-16431-15	Sound	EPROM Assembly
U10	A-5343-40072-1	Programming & Images	EPROM Assembly
U11	A-5343-40072-2	Programming & Images	EPROM Assembly
U12	A-5343-40072-12	Programming & Images	EPROM Assembly
U13	A-5343-40072-13	Programming & Images	EPROM Assembly
U14	5341-16431-3	Images	EPROM Assembly
U15	5341-16431-4	Images	EPROM Assembly
U16	5341-16431-5	Images	EPROM Assembly
U17	5341-16431-6	Images	EPROM Assembly
U18	A-5343-40072-23	Images	EPROM Assembly
U19	A-5343-40072-24	Images	EPROM Assembly
U20	A-5343-40072-21	Images	EPROM Assembly
U21	A-5343-40072-22	Images	EPROM Assembly
U22	5341-16431-17	Images	EPROM Assembly
U23	5341-16431-18	Images	EPROM Assembly
U24	5341-16431-19	Images	EPROM Assembly
U25	5341-16431-20	Images	EPROM Assembly
U26	5347-16378-00	High Score Memory Backup	Lithium Battery
U53	A-23250	27" Game Instructions	PIC Assembly



## CHAPTER TWO

# ADJUSTMENT, DIAGNOSTIC & AUDIT MENUS

## MENU SYSTEM

### WHAT IS THE MENU SYSTEM?

The game's Menu System is a series of auditing, game adjustments and diagnostic screens. You can easily access and apply these screens to optimize game performance. For instance...

- Use game audit screens to assess game performance.
- Use adjustment screens to help you customize game performance. For example, you can restore factory default game settings. You can also calibrate player controls for player accuracy.
- Use diagnostic screens to verify proper equipment operation.

### ACCESSING THE MENU SYSTEM

Open the coin door. Locate and press the TEST MODE switch. The game system will exit game Attract Mode and enter Diagnostic Mode. The system runs a brief self-test, and then displays the Main Menu. The Main Menu is the opening screen of the Menu System.

Game audits, adjustments and diagnostics are line items on the Main Menu. Selecting an item opens its submenu. Every submenu presents various options that you may act upon.

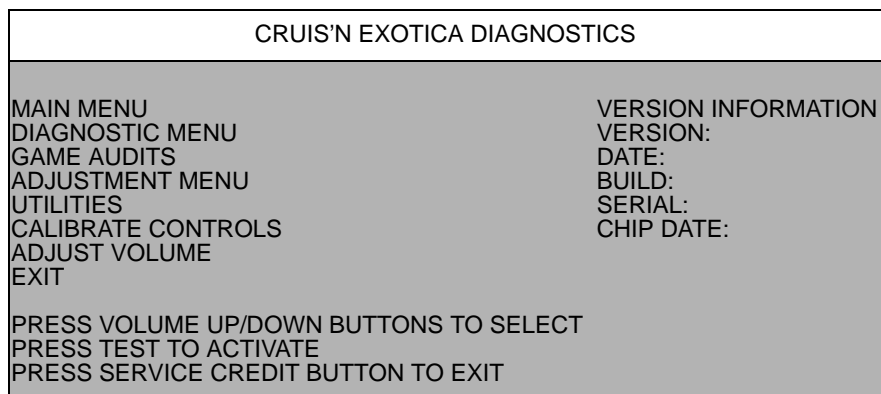

**TYPICAL MAIN MENU SCREEN**

### MENU LAYOUT

Observe that each menu screen basically uses the same layout. The game ID, Serial Number, and Date of Manufacture will appear on most of the menu screens. These numbers will be helpful to factory personnel when referring to your game for parts or service.

- The block at the top of each screen displays the current menu title.
- Data, such as menu items and video reports, etc., appears in the center of the screen.
- Messages, for example explanations and active control functions, etc., appear at the bottom of the screen.

### MENU NAVIGATION TOOLS

Use the operator control buttons located inside the coin door to navigate menus. Press the Volume Up or Volume Down buttons to scroll through the menu options.

Notice the options sequentially become highlighted. Press the Test button to select a highlighted option and access the next menu level. **NOTE:** Only one highlighted option can be selected at a time.

To return to play mode, select Exit and press the Test button while in the Main Menu screen.

<i>Main Menu, continued</i>
<b>Diagnostics Menu</b>

**DIAGNOSTIC MENU**

To verify the condition of the electrical and electronic hardware in the game, select Diagnostics Menu at the Main Menu. Diagnostic tests assist you in checking and adjusting the game’s major systems. It is important to periodically run diagnostics to improve and maintain game performance and player satisfaction.

DIAGNOSTIC MENU
SWITCH TEST
MOTION TEST
DIP SWITCH TEST
CPU BOARD TEST
SOUND BOARD TEST
LINKING TEST
STEERING WHEEL TEST
MONITOR TEST
BURN-IN TEST
LAMP TEST
LED TEST
EXIT TO MAIN MENU
PRESS VOLUME UP/DOWN BUTTONS TO SELECT
PRESS TEST TO ACTIVATE
PRESS SERVICE CREDIT BUTTON TO EXIT

Use the Volume Up or Volume Down button to highlight the desired Diagnostic Menu option and press the Test button to enter.

<i>Main Menu</i>
<i>Diagnostic Menu, continued</i>
<b>Switch Test Menu</b>

**SWITCH TEST**

To verify proper operation of switch and button inputs in the game, select SWITCH TEST at the Main Menu.

SWITCH TEST			
PRESS SERVICE CREDIT TO EXIT	CMOS VALUE		
	MIN	CENTER	MAX
POT READING	XX	XXX	XXX
STEERING WHEEL XXX	XX		XX
GAS PEDAL XX	XX	XXX	XXX
BRAKE PEDAL XX			
VIEW 1	SHIFT 1	SHIFT 3	
VIEW 2			
VIEW 3	SHIFT 2	SHIFT 4	
START			
COIN 1 LEFT			KEYPAD
COIN 2 RIGHT	TEST		1 2 3
COIN 3 CENTER	VOLUME UP		4 5 6
COIN 4	VOLUME DOWN		7 8 9
RADIO	SERVICE CREDIT		- 0 -

<b>Main Menu</b>
<b>Diagnostic Menu, continued</b>
<b>Switch Test Menu, continued</b>

Use the Volume Up or Volume Down button to highlight the Switch Test option and press the Test access it. Press any switch on the control panel or coin door to cause the corresponding indicator on the screen to illuminate. Each illuminated square represents one completed switch circuit.

<b>Main Menu</b>
<b>Diagnostic Menu, continued</b>
<b>Motion Test</b>

**MOTION TEST**

To verify functionality of motion seat controls, select MOTION TEST at the Main Menu.

	<p><b>NOTICE</b>                  Selecting any test from the Motion Test Menu will activate the seat causing it to automatically begin to move on its own. Use caution when conducting tests from this menu.</p>
---	---

Use the Volume Up or Volume Down button to highlight the Motion Test option and press the Test button to access it. Use the Service Credits button at any time to exit the Motion Test and return to the Main Menu.

MOTION TEST	
HOME POSITION	MOTION ERRORS: X
OPERATIONS TEST	MOTION VERSION: X
TILT LEFT	ERROR:
TILT RIGHT	CODE: X
TILT FORWARD	
TILT BACK	
CLEAR MOTION ERRORS	
BURN-IN TEST	
PRESS VOLUME UP/ DOWN BUTTONS TO SELECT PRESS SERVICE CREDIT BUTTON TO EXIT	

**HOME POSITION** automatically centers the motion seat so that it is positioned upright and does not tilt at any angle.

**OPERATIONS TEST** automatically cycles through each of the other test options.

**TILT LEFT** automatically tilts the seat at a left leaning angle.

**TILT RIGHT** automatically tilts the seat at a right leaning angle.

**TILT FORWARD** automatically tilts the seat at forward-facing angle.

**TILT BACK AUTOMATICALLY TILTS THE SEAT IN A BACKWARD-FACING ANGLE.**

**CLEAR MOTION ERRORS** erases any errors form memory.

**BURN-IN TEST** diagnoses intermittent circuit board problems. This test automatically cycles non-stop and *cannot* be stopped by pressing the Service Credit button.



<b>Main Menu</b>
<b>Diagnostic Menu, continued</b>
<b>DIP Switch Test</b>

**DIP SWITCH TEST**

To verify the functionality of both 8-position DIP switches on the CPU Board, select DIP SWITCH TEST at the Main Menu. Observe immediate on-screen results by changing the setting on a switch.

Use the Volume Up or Volume Down button to highlight the DIP Switch Test option and press the Test button to access it. The current settings appear on-screen. Consult the table on the next page to determine if changes are required. The default switch positions are all OFF for standard operation.

A vertical bar next to the switch position column indicates a common switch function.

DIP SWITCH TEST	
DIP SWITCH 1	DIP SWITCH 2
1 OFF DEDICATED	1 OFF
2 OFF MOTION OFF	2 OFF
3 OFF UPRIGHT CABINET	3 OFF
4 OFF WHEEL INVERT OFF	4 OFF
5 OFF 32M ROM NORMAL	5 OFF
6 OFF LINK DISABLED	6 OFF
7 OFF SHARED LINK GAME #	7 OFF
8 OFF SHARED LINK GAME #	8 OFF
PRESS ANY BUTTON TO EXIT	

**TYPICAL DIP SWITCH SCREEN**

**Setting Table for DIP Switch 1**

FUNCTION	SW1	SW2	SW3	SW4	SW5	SW6	SW7	SW8
DEDICATED KIT *	OFF ON							
MOTION DISABLED MOTION ENABLED		OFF ON						
UPRIGHT STYLE CABINET SIT DOWN STYLE CABINET			OFF ON					
WHEEL INVERT DISABLED** WHEEL INVERT ENABLED	SEE NOTES BELOW			OFF ON				
32M ROM NORMAL 16M ROM					OFF ON			
LINK DISABLED LINK ENABLED						OFF ON		
LINKING ID NUMBER MASTER (GAME NUMBER 1) SLAVE (GAME NUMBER 2) SLAVE (GAME NUMBER 3) SLAVE (GAME NUMBER 4)							OFF ON OFF ON	OFF ON OFF ON

\*DIP 1, Switch 1 must be set to the ON position in order for proper kit operation.

\*\*DIP 4, Switch 1 must be set to OFF for *Cruis'n USA™* and *Cruis'n World™* game conversions; DIP 4, Switch 1 must be set to ON position for *OffRoad Challenge™* game conversions in order to reverse wheel motion and allow the shifter to be read as Normally Closed.

<b>Main Menu</b>
<b>Diagnostic Menu, continued</b>
<b>DIP Switch Test, continued</b>

## Game Adjustments for Linked Operation

To avoid confusion, we recommend that all adjustments be set to identical values before Video Game Machines (VGMs) are linked. VGMs might operate incorrectly if this is not the case, with the following exceptions:

**NOTE:** All cabinets must have compatible software in order to link properly. Unlock the coin door and press the TEST button. The software version number is found on the Main Menu screen in game diagnostics. It does not matter what version is installed as long as all version numbers are the same.

1. **Linked VGMs must all have compatible software versions.** Newer versions may contain instructions that previous versions do not have, causing them to halt or reset at random. On-screen messages will indicate that different versions are in use when the linking feature is enabled for each.
2. **The graphic effects and added attractions for the slave cabinets must be the same as the master.** All games must have these features enabled or all must have them disabled. Mixed settings, for example road kill or a show girls setting, can cause games to become unsynchronized during competition and lead to incorrect final results (i.e., two first place finishes with different times, collisions with unseen objects, etc.).
3. **The linking feature overrides some of the individual software settings.** For instance, the master (VGM #1) sets and controls the difficulty level for all linked slaves. The difficulty level reported by the slave games may not match the setting of the master game.
4. **The linked game with the highest ranking determines software settings.** Adjustments such as bonus times will be controlled by the games in decreasing identification order. For example, if four games are linked, slave game #3 will always override game #4 but have no effect on games #1 or #2. This permits games to have different standards to help equalize players with different skill levels.

**The linking cables attach to a connector on a metal bracket located under the CPU Board Assembly at the rear of the cabinet. Unlock and remove the cabinet rear door for linking access.**

### Notes on Linking:

1. For a 2-way link, the leftmost VGM is the master (#1); the second VGM is slave #2. One linking cable is required.
  - For a 3-way link, the left VGM is the master (#1); the center and right VGMs are slaves #2 and #3. Two cables are required.
  - For a 4-way link, the leftmost VGM is the master (#1); the left center VGM is slave #2, right center machine is #3, and the right most machine is slave #4. Three linking cables are required.
2. *The linking feature will **not** function if the master is not turned on and in normal game play mode.* If the master is turned off, disconnected from the linking cable, or in any other mode of operation (offline, diagnostics, etc.), none of the slaves will be able to link.

<b>Main Menu</b>
<b>Diagnostic Menu, continued</b>
<b>DIP Switch Test, continued</b>

•The linking feature will function for all other VGMs if one of the slaves is not turned on and in normal game play mode. If any slave is turned off, disconnected from the linking cable, or in any other mode of operation (offline, diagnostics, etc.), the linking ability of other slaves will not be affected.

•The linking feature will function for some VGMs, and not others, if all of the link activity switches are not enabled or the software version numbers are not the same. The master game will not recognize other games with disabled linking or different link identification numbers.

## Game Adjustments for Coinage

Setting Table for DIP Switch 2

COUNTRY CODE	SW1	SW2	SW3	SW4	SW5	SW6	SW7	SW8
USA	OFF*	OFF*	OFF*	OFF*	OFF*			
GERMANY	ON	OFF	OFF	OFF	OFF			
FRANCE	OFF	ON	OFF	OFF	OFF			
CANADA	ON	ON	OFF	OFF	OFF			
SWITZERLAND	OFF	OFF	ON	OFF	OFF			
ITALY	ON	OFF	ON	OFF	OFF			
UK	OFF	ON	ON	OFF	OFF			
SPAIN	ON	ON	ON	OFF	OFF			
AUSTRALIA	OFF	OFF	OFF	ON	OFF			
JAPAN	ON	OFF	OFF	ON	OFF			
TAIWAN	OFF	ON	OFF	ON	OFF			
AUSTRIA	ON	ON	OFF	ON	OFF			
BELGIUM	OFF	OFF	ON	ON	OFF			
SWEDEN	OFF	OFF	OFF	OFF	ON			
FINLAND	ON	OFF	OFF	OFF	ON			
NETHERLANDS	OFF	ON	OFF	OFF	ON			
NORWAY	ON	ON	OFF	OFF	ON			
DENMARK	OFF	OFF	ON	OFF	ON			
HUNGARY	ON	OFF	ON	OFF	ON			
GENERAL	ON	ON	ON	OFF	ON			
USA1/GER1/FR1/SPN1/AUSTRIA//1/GEN1						OFF	OFF	
USA3/GER1/FR1/SPN1/AUSTRIA//1/GEN3						ON	OFF	
USA7/GER1/FR1/SPN1/AUSTRIA//1/GEN5						OFF	ON	
USA8/GER1/FR1/SPN1/AUSTRIA//1/GEN7						ON	ON	
CAN1/SW1/ITL1/UK1/JPN1/TWN1/BLGN1						OFF	OFF	
CAN2/SW2/ITL2/UK2/JPN2/TWN2/BLGN2						ON	OFF	
CAN3/SW3/ITL3/UK3/JPN3/TWN3/BLGN3						OFF	ON	
NTRLNDS1/ FNLD1/NWY1/DNMK1/HUN1						OFF	OFF	
NTRLNDS2						ON	OFF	

### DIP SWITCH SETTING FOR COINAGE

There are many ways to select the type and quantity of currency recognized by the game machine.

1. The most common coin combinations for several countries are pre-programmed and may be selected from the table when Standard Pricing is activated (see Adjustments, pg. 16).
2. DIP Switch settings may be changed with the power switched on. Set any switch and then observe the screen to verify that the desired selection is enabled. **NOTE:** If CMOS Coin Settings are active (set to ON), switch settings for an individual Country will have no effect.
3. Some European countries may accept currency used in other countries. The most popular coinage settings are listed beneath 'Other' in the Standard Pricing Table.

<b>Main Menu</b>
<b>Diagnostic Menu, continued</b>
<b>DIP Switch Test, continued</b>

4. Alternate settings are listed beneath 'General' in the Standard Pricing Table.
5. Default settings are denoted by an (\*). Switches 1 through 5 select country codes. Switches 6 and 7 are used to select one of four modes for each country.

<b>Main Menu</b>
<b>Diagnostic Menu, continued</b>
<b>CPU Board Test</b>

**CPU BOARD TEST**

To verify proper operation of memory circuits, select CPU BOARD TEST at the Main Menu. This test checks the memory circuits in a manner similar to the Start-Up Test. A pattern representing the layout of the RAM and ROM circuits on the CPU Board will appear on-screen while the video circuits are tested.

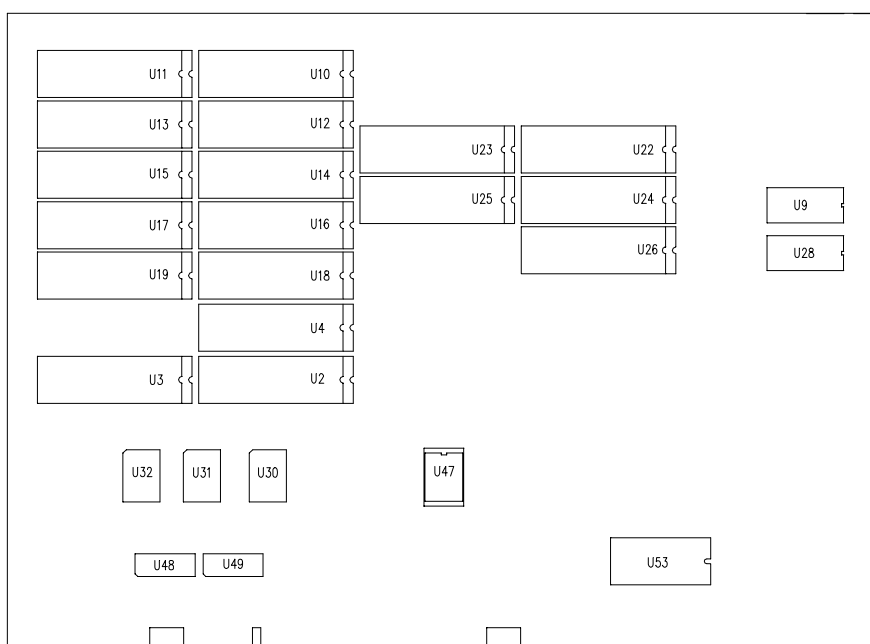

**TYPICAL CPU RAM & ROM PATTERN**

Use the Volume Up or Volume Down button to highlight CPU Board Test and press the Test button. The memory circuits are shown as gray with a white outline. During the test, good ICs are colored green; faulty ICs are colored red. Press the Service Credits button to return to the Diagnostic Menu.

<b>Main Menu</b>
<b>Diagnostic Menu, continued</b>
<b>Sound Board Test</b>

### SOUND BOARD TEST

To verify proper operation of sound components, select SOUND BOARD TEST at the Main Menu. This test allows you to access and listen to the sounds used in the game.

SOUND BOARD TEST	
UP	TO CHANGE MUSIC
DOWN	TO TRIGGER SOUND EFFECTS
SERVICE CREDIT	TO EXIT
TUNE	
SPEED LOOP	
SOUND EFFECT	
GIRL SPEECH	

Use the Volume Up or Volume Down button to highlight the Sound Board Test option and press the Test button. Press Service Credit to return to the Diagnostic Menu when finished.

<b>Main Menu</b>
<b>Diagnostic Menu, continued</b>
<b>Linking Test</b>

### LINKING TEST

To verify communications between the game machine and others connected to it, select Linking Test at the Main Menu.

LINKING TEST	
MACHINE 1 MASTER	ACTIVE
MACHINE 2 SLAVE	ACTIVE
MACHINE 3 SLAVE	ACTIVE
MACHINE 4 SLAVE	ACTIVE
TOTAL TRANSMISSIONS	X
TOTAL ERRORS	X
LINK ENABLED	
LINKED GAME NUMBER	X
PRESS TEST TO CLEAR ERRORS	
PRESS SERVICE CREDITS BUTTON TO EXIT	

Use the Volume Up or Volume Down button to highlight the Linking Test option and press the Test button. This test runs automatically and will display all results on-screen.

Press Service Credit to clear errors and restart the test cycle. Press the Test button to exit from this menu screen.

<i>Main Menu</i>
<i>Diagnostic Menu, continued</i>
<b>Steering Wheel Test</b>

**STEERING WHEEL TEST**

To verify the proper directional movement of the steering wheel, select Steering Wheel Test at the Main Menu. Make sure hands and other objects are clear of the steering wheel when this test is selected because the wheel will automatically rotate on its own. Follow the on-screen instructions.

STEERING WHEEL TEST
TURN WHEEL LEFT PRESS TEST TO CONTINUE
TURN WHEEL RIGHT PRESS TEST TO CONTINUE

Use the Volume Up or Volume Down button to highlight Steering Wheel Test and press the Test button. The steering wheel immediately turns to the left. Press the Test button a second time and the wheel turns to the right and will automatically return to the Diagnostic Menu.

<i>Main Menu</i>
<i>Diagnostic Menu, continued</i>
<b>Monitor Test</b>

**MONITOR TEST**

To verify color clarity of the monitor, select Monitor Test at the Main Menu.

Use the Volume Up or Volume Down button to highlight the desired monitor test and press the Test button. Repeatedly press the Test button to cycle through test screens and automatically return to the Main Menu. Watch for the following results on-screen during this test.

**COLOR BARS.** Observe 4 color bars in different shades appear on-screen as aids in adjusting the green, blue, and red color levels. Each color should appear sharp and clear. Check video brightness and contrast.

The **CROSSHATCH PATTERNS** test fills the screen with a series of dots within a grid. Observe the dots are perfectly round and that both the grid and dots are clear. Inspect monitor convergence, linearity, and screen size.

If any of the tests show a need for CRT adjustment, use the proper knobs on the Monitor Controls board.

<i>Main Menu</i>
<i>Diagnostic Menu, continued</i>
<b>Burn-In Test</b>

**BURN-IN TEST**

To properly diagnose intermittent CPU Board problems, select Burn-In Test at the Main Menu. This test cycles non-stop through the CPU Board Test.

A pattern representing the layout of the RAM and ROM circuits on the CPU Board will appear on-screen while the video circuits are tested.

<b>Main Menu</b>
<b>Diagnostic Menu, continued</b>
<b>Burn-In Test, continued</b>

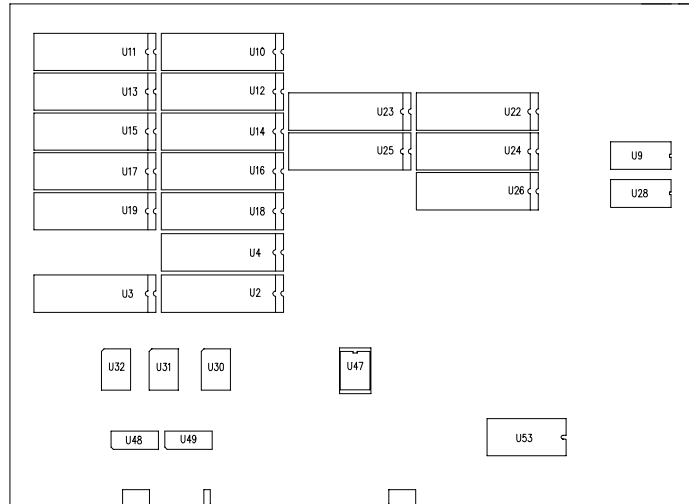

Use the Volume Up or Volume Down button to highlight Burn-In Test and press the Test button to activate. The Burn-In Test will stop and display an error message on-screen if an error is detected.

Inputs from the control buttons are ignored during Burn-In. The Burn-In Test cannot be halted from the menus. To halt the test switch off power to the game machine and then power back up.

<b>Main Menu</b>
<b>Diagnostic Menu, continued</b>
<b>Lamp Test</b>

**LAMP TEST**

To detect intermittent or faulty incandescent bulbs, select Lamp Test at the Main Menu. This test ensures that the incandescent bulbs critical to game operation function properly.

Use the Volume Up or Volume Down button to highlight Lamp Test and press the Test button. During the test observe the selected lamp switches turn *on* or *off* when the corresponding selection is made.

LAMP TEST
TURN ALL LAMPS
TURN OFF ALL LAMPS
TURN ON START
TURN ON VIEW 1
TURN ON VIEW 2
TURN ON VIEW 3
TURN ON MARQUEE LAMP 1
TURN ON MARQUEE LAMP 2
PRESS VOLUME UP/DOWN TO SELECT
PRESS TEST BUTTON ACTIVATE
PRESS SERVICE CREDIT TO BUTTON EXIT

<b>Main Menu</b>
<b>Diagnostic Menu, continued</b>
<b>Lamp Test, continued</b>

**Notes on the Lamp Test**

1. The RADIO button is not illuminated and requires no lamp test.
2. The MARQUEE LAMPS are located inside the lighted header as part of the Deluxe Linking Kit.
3. To override individual tests select either TURN ON or TURN OFF ALL LAMPS. The lamps also automatically switch off when the Service Credit button is pressed to exit this screen.

Press the Service Credit button to return to the Diagnostic Menu.

<b>Main Menu</b>
<b>Diagnostic Menu, continued</b>
<b>LED Test</b>

**LED TEST**

To verify the proper functionality of the Dashboard LEDs, select LED Test at the Main Menu. This test allows you to control and test the illumination of the LED's located on the dash PCB.

Use the Volume Up and Volume Down buttons to highlight the LED Test and press the Test button. Observe the following activity on the dash PCB.

<b>LED TESTS</b>
LEDS ON LEDS OFF LEDS CYCLE  PRESS VOLUME UP/DOWN TO SELECT PRESS TEST BUTTON TO ACTIVATE PRESS SERVICE CREDIT BUTTON TO EXIT

Select **LEDs ON** to simultaneously turn on all LED's. LEDs will remain illuminated until switched off. Select **LEDs OFF** to simultaneously turn off all LED's. LEDs will not be illuminated during this phase. Select **LEDs CYCLE** to sequentially cycle through and turn each LED on and off, originating on the left-hand side of the dashboard PCB. Press the Service Credit button to halt the cycle.

<b>Main Menu</b>
<b>Game Audits</b>

**GAME AUDITS**

Press the Volume Up or Volume Down button to highlight Game Audits in the Main Menu and press the Test button. To move between pages in an Audit Table, press the Volume Up or Volume Down button. Press the Test or Start button to return to the Main Menu from this screen.

The Game Audits table displays play statistics. The Audit item is listed on the left side of the table and the amount of play appears on the right side. Record all statistics prior to performing any service or repairs.



**Main Menu****Game Audits, continued**

GAME AUDITS	
COIN AUDITS, PAGE 1	
COIN 1 LEFT	X
COIN 2 RIGHT	X
COIN 3 CENTER	X
COIN 4	X
BILL	X
SERVICE CREDITS	X
TOTAL STARTS	X
TOTAL CONTINUES	X
TOTAL GAMES	X
TOTAL FREE RACES	X
FREE GAMES PERCENT	X
EXPIRED RACES	X
PRESS VOLUME UP/DOWN FOR NEXT PAGE	
PRESS SERVICE CREDIT BUTTON TO EXIT	

**AUDIT TABLE, PAGE 1**

GAME AUDITS	
MISC. AUDITS, PAGE 2	
POWER-ON TIME SECONDS	X
GAME TIME SECONDS	X
AVERAGE TIME SECONDS	X
KEYPAD LOG-INS	X
EVENT	X
U-GAMES	X
WATCHDOG(S)	X
MOTION ERRORS	X
BURN-IN LOOPS	X
PRESS VOLUME UP/DOWN FOR NEXT PAGE	
PRESS SERVICE CREDIT BUTTON TO EXIT	

**AUDIT TABLE, PAGE 2**

GAME AUDITS	
VEHICLE SELECTED, PAGE 3	
JEEP	X
PROWLER	X
VETTE	X
HUMMER	X
NASH	X
MUSTANG	X
TRIPY	X
UGLY CAR	X
JET CAR	X
VIPER	X
MUSCLE CAR	X
SEMI	X
PRESS VOLUME UP/DOWN FOR NEXT PAGE	
PRESS SERVICE CREDIT BUTTON TO EXIT	

**AUDIT TABLE, PAGE 3**

<b>Main Menu</b>
<b>Game Audits, continued</b>

GAME AUDITS	
SPECIAL EFFECTS, PAGE 4	
AUTOMATIC SELECTED	X
MANUAL SELECTED	X
CUSTOM PAINT JOBS	X
WHEELIES	X
HORN BEEPED	X
TRICK JUMPS	X
SPINOUTS	X
CAM 1 TIME SECS	X
CAM 2 TIME SECS	X
CAM 3 TIME SECS	X
PRESS VOLUME UP/DOWN FOR NEXT PAGE	
PRESS SERVICE CREDIT BUTTON TO EXIT	

**AUDIT TABLE, PAGE 4**

GAME AUDITS	
INDIVIDUAL TRACK SELECTED, PAGE 5	
VEGAS	X
KOREA	X
ALASKA	X
ATLANTIS	X
HONG KONG	X
INDIA	X
SAHARA	X
HOLLAND	X
IRELAND	X
AMAZON	X
TIBET	X
MARS	X
PRESS VOLUME UP/DOWN FOR NEXT PAGE	
PRESS SERVICE CREDIT BUTTON TO EXIT	

**AUDIT TABLE, PAGE 5**

GAME AUDITS	
CRUIS'N EXOTICA STARTS, PAGE 6	
VEGAS	X
KOREA	X
ALASKA	X
ATLANTIS	X
HONG KONG	X
INDIA	X
SAHARA	X
HOLLAND	X
IRELAND	X
AMAZON	X
TIBET	X
MARS	X
PRESS VOLUME UP/DOWN FOR NEXT PAGE	
PRESS SERVICE CREDIT BUTTON TO EXIT	

**AUDIT TABLE, PAGE 6**

**Main Menu****Game Audits, continued**

GAME AUDITS	
TRACK WINS, PAGE 7	
VEGAS	X
KOREA	X
ALASKA	X
ATLANTIS	X
HONG KONG	X
INDIA	X
SAHARA	X
HOLLAND	X
IRELAND	X
AMAZON	X
TIBET	X
MARS	X
PRESS VOLUME UP/DOWN FOR NEXT PAGE	
PRESS SERVICE CREDIT BUTTON TO EXIT	

**AUDIT TABLE, PAGE 7**

GAME AUDITS	
DRIVER SELECTION, PAGE 8	
JEN	X
JASON	X
CLOWN	X
RETRO	X
DUDE	X
ASIAN	X
BABY	X
AFM	X
COWBOY	X
ALIEN	X
PRESS VOLUME UP/DOWN FOR NEXT PAGE	
PRESS SERVICE CREDIT BUTTON TO EXIT	

**AUDIT TABLE, PAGE 8**

GAME AUDITS	
BIG-HEAD DRIVER SELECTION, PAGE 9	
JEN BIG-HEAD	X
JASON BIG-HEAD	X
CLOWN BIG-HEAD	X
RETRO BIG-HEAD	X
DUDE BIG-HEAD	X
ASIAN BIG-HEAD	X
BABY BIG-HEAD	X
AFM BIG-HEAD	X
COWBOY BIG-HEAD	X
ALIEN BIG-HEAD	X
PRESS VOLUME UP/DOWN FOR NEXT PAGE	
PRESS SERVICE CREDIT BUTTON TO EXIT	

**AUDIT TABLE, PAGE 9**

<b>Main Menu</b>
<b>Adjustment Menu</b>

**ADJUSTMENT MENU**

To optimize game performance and earnings or to change the look or sound of the game, select the Adjustment Menu at the Main Menu. The Attract Mode features, Game Pricing and Game difficulty may also be customized, along with awarding free races to encourage players. *Free game player incentives may reduce earnings.* **NOTE:** Individual Game Adjustments are explained in more detail on the following pages.

Press the Volume Up or Volume Down button to highlight the desired Adjustments Menu option on the Main Menu and press the Test button. Use these screens to optimize game performance and earnings.

The Adjustments Menu offers several options. Press the Volume Up or Volume Down button to highlight an option and press the Test button. Each time an option on the menu is activated you are provided with multiple setting choices. Use the Volume Up or Down button to change the current value setting and observe a confirmation box as shown below appears.

SELECT THIS PRICING? ARE YOU SURE?	
YES	NO
TEST TO ACCEPT UP TO INCREASE DOWN TO DECREASE	

**TYPICAL CONFIRMATION BOX**

Press the Volume Up or Volume Down to make your selection, then press the Test button to lock in the setting. Selecting NO cancels any changes changed values and returns the previous values to memory.

ADJUSTMENT VALUES	
STANDARD PRICING--USA 1	ON
CUSTOM PRICING	OFF
FREE PLAY	OFF
FIRST PLACE GETS FREE RACE	ON
START TIME BONUS SECONDS	75
CHECKPOINT BONUS SECONDS	20
ATTRACT MODE SOUNDS	OFF
INITIAL ENTRY	ON
MINIMUM VOLUME LEVEL	11
STEERING WHEEL POWER	5
SPEED IN MPH OR KPH	MPH
KEYPAD ACTIVE	OFF
MANUAL TRANS DISABLED	OFF
SHOW ROADKILL	ON
SHOW ENDING	ON
SHOW GIRLS	ON
HIGH SCORE RESET	5000
GAME DIFFICULTY	5
MAXIMUM CREDITS	30
MULTI-PLAYER FREE RACES	OFF
PRESS VOLUME UP/DOWN TO SELECT PRESS TEST BUTTON TO ACTIVATE PRESS SERVICE CREDIT BUTTON TO EXIT	

<b>Main Menu</b>
<b>Adjustment, continued</b>
<b>Pricing Table,</b>

Use the Pricing Table illustrated below as a guide to select and/or verify the desired coin credit setting(s).

NAME	START	CONTINUE	CREDITS/COIN	COIN 1	COIN 2	COIN 3	COIN4	BILL
ANTILLES	2	2	1/25¢, 4/1G	.25¢	1G			
AUSTRALIA 1	2	2	1/3X20¢, 2/\$1.00	.20¢	\$1.00			
AUSTRALIA 2	1	1	1/5X20¢, 1/\$1.00	.20¢	\$1.00			
AUSTRIA 1	2	2	1/5Sch, 2/10Sch	5 Sch	10 Sch			
AUSTRIA 2	2	2	1/2X5Sch, 3/2X10Sch	5 Sch	10 Sch			
BELGIUM 1	2	2	1/20BF	20BF	20BF			
BELGIUM 2	2	2	3/20BF	20BF	20BF			
BELGIUM 3	2	2	2/20BF	20BF	20BF			
BELGIUM ECA	2	2	1/20BF	50BF	20BF	5BF		
CANADA 1	2	2	1 / 2 x 25¢, 3 / \$1	25¢	25¢			
CANADA 2	2	2	1 / 2 x 25¢, 3 / \$1	25¢	\$1.00			
CANADA 3	2	2	3 / \$1.00, 6 / \$2.00	\$1.00	\$2.00			
CANADA ECA	2	2	1 / 2 x 25¢, 3 / \$1	25¢		\$1.00	\$2.00	
DENMARK	2	2	3/5DKr, 7/10DKr	5DKr	10DKr			
FINLAND	2	2	1/1Fmk	1Fmk	5Fmk			
FRANCE 1	2	2	2/5Fr, 5/10Fr	5Fr	10Fr			
FRANCE 2	2	1	2/5Fr, 4/10Fr	5Fr	10Fr			
FRANCE 3	2	1	1/5Fr, 3/10Fr	5Fr	10Fr			
FRANCE 4	2	1	1/5Fr, 2/10Fr	5Fr	10Fr			
FRANCE 5	2	1	2/5Fr, 5/10Fr, 11/2 X 10Fr	5Fr	10Fr			
FRANCE 6	2	1	2/5Fr, 4/10Fr, 9/2 X 10Fr	5Fr	10Fr			
FRANCE 7	2	1	1/5Fr, 3/10Fr, 7/2 X 10Fr	5Fr	10Fr			
FRANCE 8	2	1	1/5Fr, 2/10Fr, 5/2 X 10Fr	5Fr	10Fr			
FRANCE 9	2	1	1/3 X 1Fr, 2/5Fr	1Fr	5Fr			
FRANCE 10	2	1	1/2 X 1Fr, 3/5Fr	1Fr	5Fr			
FRANCE 11	2	1	1/3 X 1Fr, 2/5Fr, 5/2 X 5Fr	1Fr	5Fr			
FRANCE 12	2	1	1/2 X 1Fr, 3/5Fr, 7/2 X 5Fr	1Fr	5Fr			
FRANCE ECA 1	1	1	2/5Fr, 5/10Fr	1Fr	5Fr	10Fr	20Fr	
FRANCE ECA 2	1	1	2/5Fr, 4/10Fr	1Fr	5Fr	10Fr	20Fr	
FRANCE ECA 3	1	1	1/5Fr, 3/10Fr	1Fr	5Fr	10Fr	20Fr	
FRANCE ECA 4	1	1	1/5Fr, 2/10Fr	1Fr	5Fr	10Fr	20Fr	
FRANCE ECA 5	1	1	2/5Fr, 5/10Fr, 11/2 X 10Fr	1Fr	5Fr	10Fr	20Fr	
FRANCE ECA 6	1	1	2/5Fr, 4/10Fr, 9/2 X 10Fr	1Fr	5Fr	10Fr	20Fr	
FRANCE ECA 7	1	1	1/5Fr, 3/10Fr, 7/2 X 10Fr	1Fr	5Fr	10Fr	20Fr	
FRANCE ECA 8	1	1	1/5Fr, 2/10Fr, 5/2 X 10Fr	1Fr	5Fr	10Fr	20Fr	
FRANCE ECA 9	1	1	1/3 X 1Fr, 2/5Fr	1Fr	5Fr	10Fr	20Fr	
FRANCE ECA 10	1	1	1/2 X 1Fr, 3/5Fr	1Fr	5Fr	10Fr	20Fr	
FRANCE ECA 11	1	1	1/3 X 1Fr, 2/5Fr, 5/10Fr	1Fr	5Fr	10Fr	20Fr	
FRANCE ECA 12	1	1	1/2 X 1Fr, 3/5Fr, 7/10Fr	1Fr	5Fr	10Fr	20Fr	
FRANCE ECA 13	1	1	1/10Fr, 2/20Fr, 4/30Fr	1Fr	5Fr	10Fr	20Fr	
FREE PLAY	--	--	--	None	None	None	None	None
GERMANY 1	2	2	1/1DM, 6/5DM	1DM	5DM			
GERMANY 2	2	2	1/1DM, 7/5DM	1DM	5DM			
GERMANY 3	2	1	1/1DM, 8/5DM	1DM	5DM			
GERMANY 4	2	1	1/1DM, 5/5DM	1DM	5DM			
GERMANY 5	2	1	1/1DM, 6/5DM	1DM	5DM			
GERMANY ECA 1	2	2	1/1DM, 2/2DM, 6/5DM	1DM	2DM	5DM		
GERMANY ECA 2	2	1	1/1DM, 2/2DM, 6/5DM	1DM	2DM	5DM		
GERMANY ECA 3	1	1	1/1DM, 2/2DM, 6/5DM	1DM	2DM	5DM		
HUNGARY	2	2	1/2X10Ft, 3/2X20Ft	10Ft	20Ft			
ITALY	2	2	1/500Lit	500Lit	500Lit			
JAPAN 1	2	2	1/100Yen	100 Yen	100 Yen			
JAPAN 2	2	2	2/100Yen	100 Yen	100 Yen			
JAPAN 3	1	1	1/100Yen	100	100			
JAPAN 4	1	1	2/100Yen	100	100			
JAPAN 5	1	1	4/100Yen	100	100			
JAPAN 6	1	1	1/2X100Yen	100	100			
NETHERLANDS	2	2	1/1HFI, 3/2.5HFI	1HFI	2.5HFI			
NEW ZEALAND 1	1	1	1/\$1	\$1	\$2			
NEW ZEALAND 2	1	1	2/\$1	\$1	\$2			
NORWAY	2	2	3/5Nkr, 6/10Nkr	5Nkr	10Nkr			
SPAIN 1	2	2	1/100Pta, 6/500Pta	100Pta	500Pta			
SPAIN 2	2	2	1/100Pta, 5/500Pta	100Pta	500Pta			
SWEDEN	2	2	1/3X1SKr, 2/5SKr	1SKr	5SKr			
SWITZERLAND 1	2	2	1/1SFr, 6/5SFr	1SFr	5SFr			
SWITZERLAND 2	2	2	1/1SFr, 7/5SFr	1SFr	5SFr			
SWITZERLAND 3	2	2	1/1SFr, 8/5SFr	1SFr	5SFr			
UK ECA 1	1	1	1/50p, 3/£1.00	£1.00	50p	20p	10p	£2.00

CHAPTER 2 DIAGNOSTICS

NAME	START	CONTINUE	CREDITS/COIN	COIN 1	COIN 2	COIN 3	COIN4	BILL
UK ECA 2	1	1	1/50p, 2/£1.00	£1.00	50p	20p	10p	£2.00
UK ECA 3	1	1	1/30p, 2/50p, 5/£1.00	£1.00	50p	20p	10p	£2.00
UK 4	1	1	1/50p, 3/£1.00	£1.00	50p			
UK 5	1	1	1/50p, 2/£1.00	£1.00	50p			
UK ECA 6	1	1	1/30p, 2/50p, 4/£1.00	£1.00	50p	20p	10p	£2.00
UK ECA 7	1	1	3/£1.00	£1.00	50p	20p	10p	£2.00
UK ECA 8	1	1	1/50p, 2/£1.00, 4/£2.00	£1.00	50p	20p	10p	£2.00
USA1	1	1	1/3X25¢	25¢	25¢			\$1.00
USA2	1	1	1/4X25¢	25¢	25¢			\$1.00
USA3	1	1	1/25¢	25¢	25¢			\$1.00
USA4	1	1	1/50¢, 3/\$1.00	25¢	25¢			\$1.00
USA5	2	1	1/50¢, 4/\$1.00	25¢	25¢			\$1.00
USA6	1	1	1/50¢	25¢	25¢			\$1.00
USA7	1	1	1/50¢, 3/\$1.00	25¢	25¢			\$1.00
USA8	2	2	1/50¢, 4/\$1.00	25¢	25¢			\$1.00
USA9	3	2	1/25¢, 4/\$1.00	25¢	25¢			\$1.00
USA10	3	3	1/25¢, 4/\$1.00	25¢	25¢			\$1.00
USA11	4	2	1/25¢, 4/\$1.00	25¢	25¢			\$1.00
USA12	4	3	1/25¢, 4/\$1.00	25¢	25¢			\$1.00
USA13	4	4	1/25¢, 4/\$1.00	25¢	25¢			\$1.00
USA ECA	3	3	1/25¢, 4/\$1.00	\$1.00	25¢	10¢	05¢	\$1.00
USA 15	2	1	1/25¢	25¢	25¢			\$1.00

<b>Main Menu</b>
<b>Adjustment, continued</b>
<b>Custom Pricing Menu</b>

Use the Custom Pricing Menu to specify pricing settings other than the ones listed in the Standard Pricing Table. Custom Pricing can also be used to select the amount of credits required to start a game and the amount of credits required to continue a game.

Press the Volume Up or Volume Down button to highlight an option, i.e. Left Chute, Minimum Units, etc., and press the Test button. Next, use the Volume Up or Down button to adjust the current value setting, then press the Test button to lock in the setting. Selecting NO cancels any changes changed values and returns the previous values to memory.

CUSTOM PRICING MENU	
LEFT CHUTE UNITS	X
RIGHT CHUTE UNITS	X
CENTER CHUTE UNITS	X
FOURTH CHUTE UNITS	X
BILL CHUTE UNITS	X
UNITS PER CREDIT	X
UNITS FOR BONUS	X
MINIMUM UNITS	X
CREDITS TO START	X
CREDITS TO CONTINUE	X
LEFT CHUTE COUNTER	X
RIGHT CHUTE COUNTER	X
CENTER CHUTE COUNTER	X
FOURTH CHUTE COUNTER	X
BILL CHUTE COUNTER	X
SHOW FRACTIONS	YES
SELECT CUSTOMER PRICING	NO
EXIT TO MAIN MENU	
PRESS VOLUME UP/ DOWN TO SELECT	
PRESS TEST BUTTON TO ACTIVATE	
PRESS SERVICE CREDIT BUTTON TO EXIT	

<b>Main Menu</b>
<b>Adjustment, continued</b>
<b>Custom Pricing Menu, continued</b>

The following table clarifies Custom Pricing Menu terms...

SCREEN TERM	DEFINITION
<b>CHUTE UNITS</b>	Currency inserted accumulates units. This adjustment specifies the quantity of units given for each coin or bill in each coin chute.
<b>UNITS PER CREDIT</b>	Units needed to accumulate a credit.
<b>UNITS FOR BONUS</b>	Units awarded after a player has accumulated enough points for a bonus.
<b>MINIMUM UNITS</b>	No credits will be awarded until the minimum required currency units have been accumulated.
<b>CREDITS TO START</b>	Units needed to enter game play.
<b>CREDITS TO CONTINUE</b>	Units needed to continue game play.
<b>CHUTE COUNTER</b>	Total number of units accepted by a chute.
<b>SHOW FRACTIONS</b>	Fractional credits are observable in credit screen when YES is selected.
<b>CUSTOMER PRICING</b>	Selecting YES enables custom pricing and overrides default settings.

<b>Main Menu</b>
<b>Adjustment Menu, continued</b>

To further optimize game performance and earnings, select the desired option on the Adjustment Menu. Press the Volume Up or Volume Down button to highlight the desired Adjustments Menu option on the Main Menu and press the Test button. Use these screens to optimize game performance and earnings.

Each time an option on the menu is activated you are provided with multiple setting choices. Use the Volume Up or Down button to change the current value setting and observe a confirmation box as shown below appears.

SELECT THIS PRICING? ARE YOU SURE?	
YES	NO
TEST TO ACCEPT UP TO INCREASE DOWN TO DECREASE	

**TYPICAL CONFIRMATION BOX**

Press the Volume Up or Volume Down to make your selection, then press the Test button to lock in the setting. Selecting NO cancels any changes changed values and returns the previous values to memory.

<b>Main Menu</b>
<b>Adjustment, continued</b>
<b>Free Play Menu</b>

**Free Play**

This option selects free play. The setting choices for this adjustment are:

- On
- Off
- Factory Setting: Off**

<b>Main Menu</b>
<b>Adjustment, continued</b>
<b>First Place Awards Free Game Menu</b>

**First Place Awards Free Game**

Awards a player a free game upon a first place finish. The setting choices are:

- On
- Off
- Factory Setting: On**

<b>Main Menu</b>
<b>Adjustment, continued</b>
<b>Start Time Bonus Seconds Menu</b>

**Start Time Bonus Seconds**

Determines the initial amount of time a player is given to finish a race. The setting choices are:

- Maximum: 90
- Minimum: 60
- Factory Setting: 75**

<b>Main Menu</b>
<b>Adjustment, continued</b>
<b>Checkpoint Bonus Time Menu</b>

**Checkpoint Bonus Time**

Awards a player a time bonus for passing a checkpoint. The setting choices are:

- Maximum: 10
- Minimum: 25
- Factory Setting: 20**



<b>Main Menu</b>
<b>Adjustment, continued</b>
<b>Attract Sound</b>

**Attract Sound**

This option selects the attract mode sounds. The setting choices for this adjustment are:

- On
- Off
- Factory Setting: Off**

<b>Main Menu</b>
<b>Adjustment, continued</b>
<b>Initial Entry Menu</b>

**Initials Entry**

This enables players to enter their initials following a successful race. The setting choices are:

- On
- Off
- Factory Setting: On**

<b>Main Menu</b>
<b>Adjustment, continued</b>
<b>Minimum Volume Level Menu</b>

**Minimum Volume Level**

This determines the minimum volume level of the game sounds. The setting range is:

- Maximum: 30
- Minimum: 0
- Factory Setting: 11**

<b>Main Menu</b>
<b>Adjustment, continued</b>
<b>Steering Wheel Power Menu</b>

**Steering Wheel Power**

This selects the amount of power provided to steering. The setting range is:

- Maximum: 10
- Minimum: 1
- Factory Setting: 5**

<b>Main Menu</b>
<b>Adjustment, continued</b>
<b>Speed in MPH or KPH Menu</b>

**Speed in MPH or KPH**

This determines the speedometer setting in miles per hour or kilometers per hour. The setting range is:

- MPH
- KPH
- Factory Setting: **MPH**

<b>Main Menu</b>
<b>Adjustment, continued</b>
<b>Manual Trans Disabled Menu</b>

**Manual Trans Disabled**

This provide control of the manual transmission option. The setting range is:

- On
- Off
- Factory Setting: **Off**

<b>Main Menu</b>
<b>Adjustment, continued</b>
<b>Keypad Active Menu</b>

**Keypad Active**

This determines whether a player is allowed to use the keypad for inputs. The setting range for a kit is:

- On
- Off
- Factory Setting: **Off**

<b>Main Menu</b>
<b>Adjustment, continued</b>
<b>Show Roadkill Menu</b>

**Show Roadkill**

This determines if dead animals are shown in the game. The setting range is:

- On
- Off
- Factory Setting: **On**

<i>Main Menu</i>
<i>Adjustment, continued</i>
<b>Show Ending Menu</b>

**Show Ending**

This determines if an image of the President is shown upon completion of a game. The setting range is:

- On
- Off
- Factory Setting: **On**

<i>Main Menu</i>
<i>Adjustment, continued</i>
<b>Show Girls Menu</b>

**Show Girls**

This determines if “sexy” girls are shown at various points in the game. The setting range is:

- On
- Off
- Factory Setting: **On**

<i>Main Menu</i>
<i>Adjustment, continued</i>
<b>High Score Reset Menu</b>

**High Score Reset**

This determines the number of points required to reset the high score. The setting range is:

- Maximum: 25000
- Minimum: 1000
- Factory Setting: **5000**

<i>Main Menu</i>
<i>Adjustment, continued</i>
<b>Game Difficulty Menu</b>

**Game Difficulty**

This determines the level of difficulty for the game. The setting range is:

- Easiest 0
- Hardest 9
- Factory Setting: **5**

<b>Main Menu</b>
<b>Adjustment, continued</b>
<b>Maximum Credits Menu</b>

**Maximum Credits**

This allows the operator to select the maximum number of credits allotted. The setting range is:

- Maximum: 99
- Minimum: 1
- Factory Setting: 30

<b>Main Menu</b>
<b>Adjustment, continued</b>
<b>Multi-Player Free Races Menu</b>

**Multi-Player Free Races**

Awards free game to top player in a 2, 3, 4 or more player race. The setting range is:

- Off
- 2 Player
- 3 Player
- 4 Player
- Factory Setting: Off

<b>Main Menu</b>
<b>Utilities</b>

**UTILITIES**

To clear bookkeeping memory and reset factory defaults, select Utilities at the Main Menu. Press the Volume Up or Volume Down button to highlight the Utilities option on the Main Menu, then press the Test button. Press the Service Credit button to return to the Main Menu from this screen.

<b>UTILITIES MENU</b>
CLEAR CREDITS CLEAR GAME AUDITS RESET HIGH SCORES RESET HIGH SCORES, PLAYER STATS DEFAULT ADJUSTMENTS FULL FACTORY RESTORE EXIT TO MAIN MENU  PRESS VOLUME UP/VOLUME DOWN TO SELECT PRESS TEST BUTTON TO ACTIVATE PRESS SERVICE CREDIT BUTTON TO EXIT

**UTILITIES MENU**

The Utilities Menu offers several options. Press the Volume Up or Volume Down button to highlight an option, then press the Test button. Each time an option on the menu is activated you are provided with multiple setting choices. Use the Volume Up or Volume Down button to change the current value setting and observe a confirmation box as shown appears.

<b>Main Menu</b>
<b>Utilities, continued</b>

ARE YOU SURE YOU WANT TO CLEAR CREDITS?	
YES	NO

**TYPICAL CONFIRMATION BOX**

Press the Volume Up or Volume Down button to select YES or NO, then press the Test button to lock in the setting. Selecting NO cancels any changes values and returns the previous values to memory.

**NOTE:** Record the numbers before they are cleared. These values cannot be restored once erased.

<b>Main Menu</b>
<b>Utilities, continued</b>
<b>Clear Credits Menu</b>

**Clear Credits**

Press the Volume Up or Volume Down buttons to highlight the Clear Credits option on the Main Menu, then press the Test button. This returns all credit values to zero and removes credit amounts from memory.

- Yes
- No

<b>Main Menu</b>
<b>Utilities, continued</b>
<b>Clear Game Audits Menu</b>

**Clear Game Audits**

Press the Volume Up or Volume Down buttons to highlight the Clear Game Audits option, then press the Test button. This returns all audit values to zero and removes totals from memory.

- Yes
- No

<b>Main Menu</b>
<b>Utilities, continued</b>
<b>Reset High Scores Menu</b>

**Reset High Scores**

Press the Volume Up or Volume Down buttons to highlight the Reset High Scores option on the Main Menu, then press the Test button. This deletes all high scores and removes player identities from memory.

- Yes
- No

<b>Main Menu</b>
<b>Utilities, continued</b>
<b>Reset High Scores Menu, Player Stats</b>

**Reset High Scores, Player Stats**

Press the Volume Up or Volume Down buttons to highlight the Reset High Scores, Player Stats option on the Main Menu, then press the Test button. This deletes player identities and high scores accessed only via game keypad. **This Utilities option NOT applicable to kit upgraded games.**

- Yes
- No

<b>Main Menu</b>
<b>Utilities, continued</b>
<b>Full Factory Restore Menu</b>

**Default Adjustments**

Press the Volume Up or Volume Down buttons to highlight the Default Adjustments option on the Main Menu, then press the Test button. This sets the adjustments back to their original values.

- Yes
- No

<b>Main Menu</b>
<b>Utilities, continued</b>
<b>Full Factory Restore Menu</b>

**Full Factory Restore**

Press the Volume Up or Volume Down buttons to highlight the Full Factory Restore option on the Main Menu, then press the Test button. This returns every variable in the game to the original factory settings.

- Yes
- No

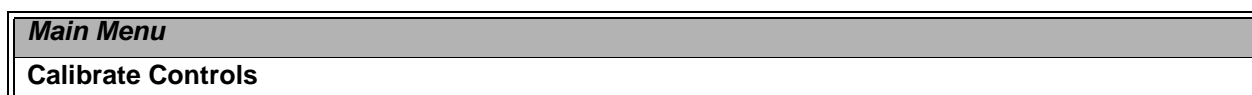
**CALIBRATE CONTROLS**

To calibrate the steering wheel and pedals, select Calibrate Controls at the Main Menu. Press the Volume

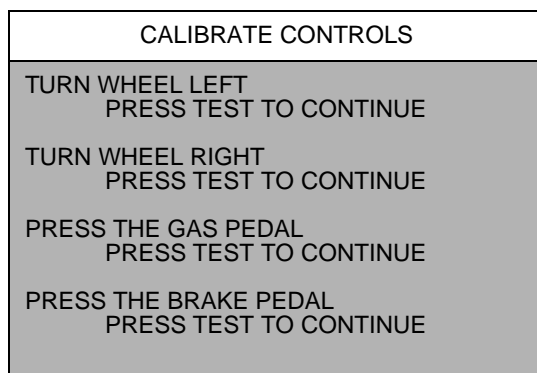

Up or Volume Down button to highlight the Control Calibration option on the Main Menu, then press the Test button. Follow the instructions on screen.

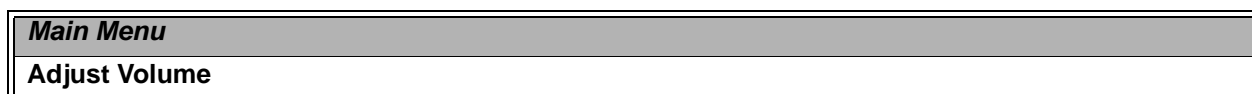
**ADJUST VOLUME**

To select a desirable volume level, select Volume Level at the Main Menu. Press the Volume Up or Volume Down button to highlight the Adjust Volume option on the Main Menu, then press the Test button. Remember that the minimum sound level is set under Game Adjustments.

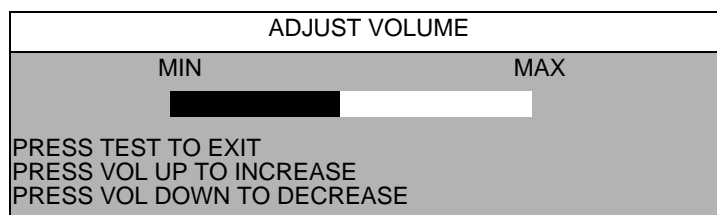

Press the Volume Up button to increase, or the Volume Down button to decrease the sound level of the game. Press the Test button to lock the volume level at the selected value and return to the Main Menu.

## NOTES





## CHAPTER THREE

# TROUBLESHOOTING



### CAUTION

This Video Game Machine (VGM) uses complex electronic components that are very sensitive to static electricity. Observe the following precautions before handling electronic assemblies. Failure to do so may void your warranty and could damage electronic assemblies.

- Before servicing electronics, turn off AC power to the VGM. Wait for capacitors to discharge.
- Before touching or handling electronic assemblies, discharge static electricity on your body. To discharge static, begin by connecting the line cord to a properly grounded outlet, but do not turn on the power! Next, touch the safety ground stud of the power supply chassis.
- Store electronic assemblies in an anti-static area. Use anti-static bags to store or transport circuit boards. Transport the hard drive in original shipping container.
- Do not remove or connect electronic assemblies when the power to the cabinet is switched on. Otherwise you'll damage electronic assemblies and void the warranty.
- Replace ground wires, shields, safety covers, etc., upon completion of maintenance or service. Install and firmly tighten all ground and mounting screws.

## COIN MECHANISM AND PRICING TROUBLESHOOTING

Symptom	Cause	Required Action
<ul style="list-style-type: none"> <li>Video Game Machine (VGM) accepts currency or tokens, but number of credits per coin or bill is incorrect.</li> </ul>	Improper settings at Pricing Menu	<ol style="list-style-type: none"> <li>Press and hold TEST MODE switch inside coin door to enter Menu System. Select SWITCH TEST from Diagnostics menu. Conduct test to confirm operation of game switches.</li> <li>Select either the STANDARD or CUSTOM PRICING MENU from Game Adjustments Menu.</li> </ol>
	Faulty wiring	<ol style="list-style-type: none"> <li>Confirm cabinet wiring is correct for this game.</li> <li>Assure coin meter and coin switches connect properly to control input wires.</li> </ol>
<ul style="list-style-type: none"> <li>VGM will not accept currency or tokens.</li> <li>VGM will not enter play mode.</li> <li>Audio and video are present.</li> </ul>	Improper currency	<ol style="list-style-type: none"> <li>Unlock and open cash door. Empty cash box and inspect revenue for counterfeit currency.</li> <li>Check vault. Remove any items that block path from mechanism.</li> </ol>
	Faulty coin mechanism	<ol style="list-style-type: none"> <li>Unlock and open coin door. Check each mechanism for proper mounting.</li> <li>Remove mechanism.</li> <li>Clear currency path.</li> <li>Reinstall mechanism and close latch.</li> </ol>
	Tilted coin mechanism or game	<ol style="list-style-type: none"> <li>Verify mechanism is level after doors close.</li> <li>Repair or replace coin door if it is bent or damaged.</li> <li>If necessary, adjust cabinet leg levelers to keep mechanisms level.</li> </ol>
<ul style="list-style-type: none"> <li>Coin indicators do not light</li> </ul>	Burned-out bulb	<ol style="list-style-type: none"> <li>Burned-out bulbs may appear white or darkened. Check continuity with digital voltmeter.</li> <li>Replace burned-out bulb with an identically rated part.</li> </ol>
	Open fuse circuit	<ol style="list-style-type: none"> <li>Check fuse continuity with digital voltmeter.</li> <li>If fuse is blown, replace fuse with an identically rated part.</li> <li>If fuse isn't blown, check wiring.</li> </ol>



### CAUTION

Do not remove or install any connector when power is turned on. Installation under power will damage the circuit boards, ROM's or hard disk and void the warranty.

## START UP TROUBLESHOOTING

Symptom	Cause	Required Action
<ul style="list-style-type: none"> <li>• Video Game Machine (VGM) does not start.</li> <li>• VGM appears completely non-functional.</li> <li>• No audio</li> <li>• No illumination</li> <li>• No video display</li> </ul>	Power problem	<ol style="list-style-type: none"> <li>1. Check power is switched on.</li> <li>2. Make sure fans are turning. If not: Is the power supply connected to its power cable? Is power supply turned on?</li> <li>3. Plug cord into AC power outlet. Verify presence of AC line voltage.</li> </ol>
	Improper line voltage switch setting	<ol style="list-style-type: none"> <li>1. Turn off power. Unplug AC line cord. Check line voltage switch. If necessary, set it to agree with local AC line voltage. Retest game.</li> </ol>
	Open fuse	<ol style="list-style-type: none"> <li>1. Turn off power. Examine AC fuse on power chassis.</li> <li>2. Examine DC fuses on cabinet wall or electronic equipment shelf.</li> <li>3. Replace faulty fuses with identically rated parts.</li> <li>4. Turn on game power. If fuse opens again, check DC wiring harness and connectors.</li> </ol>
	Faulty wiring	<ol style="list-style-type: none"> <li>1. Remove line cord. Test line cord, power plug, and IEC connector for breaks or damage. Verify continuity of each wire in cord. Install cord on power chassis. Press connector firmly to seat it.</li> <li>2. Assure that cabinet wiring harness connectors fully seat in corresponding power supply and board connectors.</li> <li>3. Inspect wiring for breaks or damage.</li> </ol>
<ul style="list-style-type: none"> <li>• Video Game Machine (VGM) does not start.</li> <li>• VGM accepts currency or tokens.</li> <li>• Audio and video are present.</li> </ul>	Faulty coin mechanism	<ol style="list-style-type: none"> <li>1. Unlock and open coin door. Check each currency acceptor to assure proper mounting. Verify each release latch is closed and locked.</li> <li>2. Test mechanism with good and bad coins to see if mechanism accepts and rejects currency correctly.</li> <li>3. Inspect to see if external acceptor indicators (Pricing, Flashing Arrows, etc.) are lit.</li> <li>4. Verify each acceptor operates properly by placing it in working game. Replace bad parts.</li> </ol>
	Faulty switches	<ol style="list-style-type: none"> <li>1. Press and hold the TEST MODE switch inside coin door to enter Menu System. Select SWITCH TESTS from the Diagnostics Menu. Conduct test to confirm operation of each switch.</li> <li>2. Assure no loose parts or wires are caught in switch contacts.</li> <li>3. Check for continuity in each suspect switch connection (Common to Normally Open or Common to Normally Closed).</li> <li>4. Replace faulty switches (bent levers, broken actuators, etc.).</li> </ol>

Symptom	Cause	Required Action
<ul style="list-style-type: none"> <li>Video Game Machine (VGM) does not start.</li> <li>VGM accepts currency or tokens.</li> <li>Audio and video are present.</li> </ul>	Faulty wiring	<ol style="list-style-type: none"> <li>Assure no wires are caught in hinges, latches or switch contacts.</li> <li>Check wiring continuity from circuit board connectors to acceptors.</li> </ol>
<ul style="list-style-type: none"> <li>Video Game Machine (VGM) appears non-functional.</li> <li>Currency acceptor price indicator is illuminated.</li> </ul>	Power problem	<ol style="list-style-type: none"> <li>Inspect circuit boards under low-light conditions. The LED's glow and the fan turns when processor circuits receive voltage and indicate presence of DC from power supply. However, voltages or signals may not be normal.</li> <li>Turn on power. Set the digital voltmeter to the 20-volt DC setting and measure DC voltages at power connector pins. Adjust the +5V source if necessary. Refer to the Cabinet Wiring Diagram for specific wiring information and voltage limits.</li> <li>Set the digital voltmeter to the 2-volt AC setting and measure DC voltages at power connector pins. Any reading here indicates that supply voltages are unstable and may contain ripple or noise.</li> </ol>
	Faulty wiring	<ol style="list-style-type: none"> <li>Turn off power. Check wiring harness connectors attach and fully seat onto mating board connectors. Verify harness connects to CPU Board. Check other connectors in same way.</li> </ol>
	Improper DIP switch settings	<ol style="list-style-type: none"> <li>Check DIP switch settings.</li> </ol>
	Faulty circuit board(s)	<ol style="list-style-type: none"> <li>Run power-up self-test sequence. Note errors or failures during test. Compare LED's with LED indicator status charts. Note discrepancies.</li> <li>Press and hold TEST MODE switch inside coin door to enter Menu System. Select MONITOR TEST from Diagnostics Menu. Conduct test to confirm operation of each screen used in the game.</li> </ol>

## LINKING PROBLEM TROUBLESHOOTING

Symptom	Cause	Required Action
<ul style="list-style-type: none"> <li>Cannot connect multiple game machines together</li> </ul>	Faulty wiring	<ol style="list-style-type: none"> <li>Do not extend linking cables supplied with VGM.</li> <li>Do not use standard telephone type couplers or wiring for linking.</li> </ol>
	Improper linking hardware	<ol style="list-style-type: none"> <li>Use required Fire Wire cable.</li> <li>Array completion requires basic kit brackets and spacers.</li> </ol>
<ul style="list-style-type: none"> <li>VGM does not recognize other players in linking operation</li> <li>VGM functions normally by itself</li> </ul>	Improper settings	<ol style="list-style-type: none"> <li>Record any error messages that occur during self-test.</li> <li>From the Diagnostic Menu select DIP SWITCH TEST. Confirm the link is enabled.</li> <li>Be sure that each VGM has a unique ID number.</li> <li>Select LINKING TEST from the Diagnostic menu. Run tests for each linked VGM.</li> </ol>
	Power problem	<ol style="list-style-type: none"> <li>Verify game electronics receive power. AC adapter wires are thin and easily damaged.</li> </ol>
	Faulty wiring (3 or more VGMs)	<ol style="list-style-type: none"> <li>Check for cable continuity from game electronics on VGM to the other game electronics.</li> <li>Assure no loose wires are caught in hinges, doors or under cabinet.</li> <li>Verify linking cable connects to CPU Board for each game.</li> <li>Verify each linking cable operates properly by placing it in working game.</li> </ol>
<ul style="list-style-type: none"> <li>Some Video Game Machines (VGMs) in group link properly, while others do not</li> </ul>	Wrong software version	Verify all linked VGMs use same version of software. Error message "VERSION MISMATCH" will appear if you try to link different versions. Contact your distributor.
	Faulty wiring (2 VGMs)	<ol style="list-style-type: none"> <li>Insert only the supplied Fire Wire linking cable to connect VGMs.</li> <li>Verify each linking cable operates properly by placing it in a working link between two VGMs.</li> </ol>
	Faulty wiring (3 or more VGMs)	<ol style="list-style-type: none"> <li>Separate communications wiring from other wiring. Wires that must cross can only cross at right angles to limit noise pickup.</li> </ol>



### CAUTION

Do not remove or install any connector when power is turned on. Installation under power will damage the circuit boards, ROM's or hard disk drive and void the warranty.

## PLAYER CONTROL TROUBLESHOOTING

Symptom	Cause	Required Action
<ul style="list-style-type: none"> <li>• Intermittent or completely non-functional player controls</li> <li>• Video Game Machine (VGM) starts normally.</li> </ul>	Faulty switches or lamps	<ol style="list-style-type: none"> <li>1. Press and hold TEST MODE switch inside coin door to enter Menu System. Select SWITCH TEST from Diagnostic Menu. Conduct tests to confirm switch operation.</li> <li>2. Press and hold TEST MODE switch inside coin door to enter Menu System. Select LAMP TEST from Diagnostic Menu. Conduct tests to confirm lamp operation.</li> <li>3. Check for loose parts or wires caught in switch contacts.</li> <li>4. Check continuity at each switch connection (Common to Normally Open or Common to Normally Closed).</li> <li>5. Verify player control operates properly by placing it in working VGM.</li> <li>6. Verify light bulbs used for dashboard switches are type specified in parts listing. Other types will light, but may produce too much heat. Excess heat may cause switches to bind.</li> </ol>
	Faulty switch wiring	<ol style="list-style-type: none"> <li>1. Check for wires caught in door hinges, latches, or switch contacts.</li> <li>2. Verify harness connectors are attached and fully seated.</li> <li>3. Assure control switches connect properly to control input wires.</li> <li>4. Check cabinet wiring is correct for this VGM.</li> </ol>
<ul style="list-style-type: none"> <li>• Steering pulls to one side</li> </ul>	Faulty Wheel Driver Board	<ol style="list-style-type: none"> <li>1. Find power amp on Wheel Driver Board's large heatsink. Test and replace bad part or board.</li> </ol>
<ul style="list-style-type: none"> <li>• No wheel feedback</li> <li>• Steering aims vehicle as expected</li> </ul>	Improperly set feedback	<ol style="list-style-type: none"> <li>1. Select STEERING WHEEL TEST on the Diagnostics Menu.</li> <li>2. Set feedback to match player requirements. Maximum force may be too extreme for very young or inexperienced customers.</li> </ol>
	Faulty circuit	<ol style="list-style-type: none"> <li>1. Examine fuses and cables on Wheel Driver Board.</li> <li>2. Check cables and wiring between CPU board, wheel driver and motor.</li> <li>3. Check resistance of motor series resistors.</li> <li>4. Replace bad parts.</li> </ol>
	Faulty motor	<ol style="list-style-type: none"> <li>1. Turn off power. Open dashboard. Support steering wheel and remove outer mounting screws.</li> <li>2. Remove metal shield (if VGM has one) over motor.</li> <li>3. Unscrew caps.</li> <li>4. Inspect motor brushes. Replace worn parts.</li> </ol>

Symptom	Cause	Required Action
<ul style="list-style-type: none"> <li>Sloppy, unpredictable or ineffective steering</li> <li>Video is present</li> <li>Video Game Machine (VGM) operates normally</li> </ul>	Blocked or faulty fan	Fan located on power supply functions as an exhaust fan. With power on, check airflow near each fan to assure that nothing blocks airflow.
	Faulty mechanical parts	Turn off power. Open dashboard. Support steering wheel and remove outer mounting screws. Remove metal shield (if VGM has one) over motor. Inspect for faulty or worn belts, bearings, couplings, gears, etc.
	Faulty Wheel Driver Board	<ol style="list-style-type: none"> <li>Inspect Wheel Driver Board under low-light conditions. To indicate presence of AC from the transformer the LED's glow when voltage is received. However, voltages or signals may not be normal.</li> <li>Examine fuses and cables on Wheel Driver Board. Replace bad fuses. Use digital voltmeter to verify AC voltage between each fuse holder and ground. You should measure approximately 25V. See Wiring Diagram.</li> <li>Use the 20-VAC setting on digital voltmeter to measure DC voltage at motor. Do not move steering wheel, drive belt, or motor while making this measurement. Any reading indicates unstable supply that may contain ripple or noise.</li> <li>Select the STEERING WHEEL TEST from the Diagnostic Menu. Follow on-screen instructions to verify operation of the wheel motor and steering position sensor.</li> <li>Verify proper operation of Wheel Driver Board by placing it in working VGM.</li> </ol>
<ul style="list-style-type: none"> <li>Inability to make a transmission selection.</li> <li>Video Game Machine (VGM) operates normally.</li> </ul>	Loose or worn drive belt	<ol style="list-style-type: none"> <li>Turn off power. Open dashboard. Support steering wheel and remove outer mounting screws. Remove metal shield (if VGM has one) over motor. Inspect for faulty or worn belts, bearings, couplings, gears, etc.</li> <li>If drive belt isn't worn or damaged, check its tightness.</li> </ol>
	Improper DIP Switch setting(s)	From the Diagnostics Menu, choose DIP SWITCH TEST. Make sure DIP 1, SW 1 is set to the OFF position.



**WARNING**

The Wheel Driver Board heatsink, power resistors, and other components may be very hot. The DC Motor in the steering wheel may also be hot.



## VIDEO TROUBLESHOOTING

Symptom	Cause	Required Action
<ul style="list-style-type: none"> <li>• Monitor appears non-functional</li> <li>• Audio is present</li> <li>• Video Game Machine (VGM) controls operate normally</li> </ul>	Power problem	Verify connection of AC Power to video monitor. Inspect neck of CRT in dim light. Glowing filament near CRT base confirms monitor circuits receive power. However, voltages or signals may not be normal.
	Faulty wiring	<ol style="list-style-type: none"> <li>1. Turn off game power. Verify that video signal and Remote Adjustment Board connectors seat properly on Video Monitor Board.</li> <li>2. Assure that no wires are caught on chassis or mounting brackets.</li> </ol>
	Improper monitor adjustments	Check BRIGHTNESS (intensity) and CONTRAST are set above their minimum levels.
	Faulty monitor circuitry	<ol style="list-style-type: none"> <li>1. Examine AC line fuse on Video Monitor Board. If fuse is faulty, replace it with an identically rated fuse.</li> <li>2. If the fuse is good, verify video monitor operates correctly by placing it in a working VGM.</li> <li>3. If monitor is bad; Check monitor power supply.</li> <li>4. If the power supply is good, Check monitor horizontal output transistor and related circuitry.</li> </ol>
<ul style="list-style-type: none"> <li>• Graphic images from game do not appear</li> <li>• No audio</li> <li>• Power-up self-test runs</li> </ul>	Improper components	<ol style="list-style-type: none"> <li>1. Verify circuit boards are correct for this game. Labels on each board record manufacturers' name, assembly number and hardware version.</li> <li>2. Verify ROM instruction set is correct for this game. Game set includes more than one ROM. Label on each ROM records assembly number and software version.</li> </ol>
	Faulty Circuit Board	<ol style="list-style-type: none"> <li>1. Allow game to load normally. Note and record any error messages that occur during self-test.</li> <li>2. Press and hold TEST MODE switch inside coin door to enter Menu System. Select Diagnostic Menu from the Main Menu. Then select CPU BOARD TEST. Conduct this test to check operation of critical components.</li> <li>3. Turn off power. Inspect CPU Board to ensure JAMMA cable connector is fully seated onto the mating edge connector of the CPU. Check all other cable connectors for correct alignment and continuity.</li> <li>4. Compare activity of LED's on CPU with the CPU Indicator Chart.</li> </ol>





Symptom	Cause	Required Action
	Power Problems	<ol style="list-style-type: none"> <li>1. Turn on Power. Use 20-volt DC setting on digital voltmeter to measure DC voltages present at Power connector pins. Verify +5V source if it is adjustable. Refer to Cabinet Wiring Diagram for specific wiring information and voltage limits.</li> <li>2. Use 2-Volt AC setting on digital voltmeter to measure DC voltages at Power Connector pins. Any reading indicates the supply voltages are unstable and may contain ripple or noise.</li> </ol>
<ul style="list-style-type: none"> <li>• White areas at screen edges appear tinged with color</li> <li>• Dots at screen edges appear ovoid or cylindrical</li> </ul>	Picture tube dynamic convergence is out of alignment	Have service bureau dynamically re-converge monitor. This procedure requires removing and repositioning yoke. Service bureau must follow instructions from monitor manufacturer.
<ul style="list-style-type: none"> <li>• Video images tear or roll, or have black bar down middle of screen</li> </ul>	Faulty wiring	<ol style="list-style-type: none"> <li>1. Check connectors and cables for wiring continuity. Video cables connect circuit boards to video monitor.</li> <li>2. Assure connection of all cabinet ground wires, especially at video monitor chassis.</li> </ol>
	Faulty monitor circuitry	<ol style="list-style-type: none"> <li>1. Verify video monitor operates correctly by connecting it to working Video Game Machine (VGM).</li> <li>2. Assure video monitor is correct type for this game. Video monitors with wrong resolution can't lock sync.</li> </ol>
	Improper sync signals	<ol style="list-style-type: none"> <li>1. Check to see if Video Board puts out type of sync that your monitor requires.</li> <li>2. Verify jumpers are set correctly for monitor.</li> </ol>
	Electromagnetic fields	Move cabinet far away from machines, appliances, or competitors' video games.
<ul style="list-style-type: none"> <li>• Missing colors</li> </ul>	Faulty wiring	Check connectors and cables for wiring continuity from circuit boards to video monitor.
	Faulty monitor color drive circuitry	Verify video monitor operates correctly by connecting it to working Video Game Machine (VGM).
<ul style="list-style-type: none"> <li>• One color is dimmer or brighter than others</li> <li>• Whites appear tinted everywhere on screen</li> </ul>	Maladjusted color bias pots	<ol style="list-style-type: none"> <li>1. Turn on Video Game Machine (VGM).</li> <li>2. From Diagnostic Menu select MONITOR TEST.</li> <li>3. Watch Color Bars screen in mirror.</li> <li>4. Adjust three bias pots for best colors. (Most monitor neck boards include these pots.)</li> <li>5. Check White Screen. Touch up controls.</li> <li>6. If whites still seem tinted, have service bureau rejuvenate picture tube.</li> </ol>

Symptom	Cause	Required Action
<ul style="list-style-type: none"> <li>Picture is too narrow</li> </ul>	Maladjusted WIDTH pot.	From Diagnostic Menu select MONITOR TEST. Watch Crosshatch Screen while adjusting WIDTH pot for best picture. You'll find this pot on Monitor Remote Control Board, behind coin door.
<ul style="list-style-type: none"> <li>Picture is too short</li> </ul>	Maladjusted HEIGHT pot or damaged vertical circuit	<ol style="list-style-type: none"> <li>From Diagnostic Menu select MONITOR TEST. Watch Crosshatch Screen while adjusting HEIGHT pot for best picture. You'll find this pot on Monitor Remote Control Board, behind coin door.</li> <li>If pot has no effect, service vertical output circuit.</li> </ol>
<ul style="list-style-type: none"> <li>Picture seems shifted to one side</li> </ul>	Maladjusted HORIZONTAL POSITION pot	From Diagnostic Menu select MONITOR TEST. Watch Crosshatch Screen while adjusting HORIZONTAL POSITION pot for best picture. You'll find this pot on Monitor Remote Control Board, behind coin door.
<ul style="list-style-type: none"> <li>Keystone-shaped picture</li> </ul>	Shorted turns in yoke	<ol style="list-style-type: none"> <li>Substitute working yoke.</li> <li>Have service bureau converge monitor.</li> <li>Retest monitor.</li> </ol>
<ul style="list-style-type: none"> <li>Blotches of color appear on screen</li> </ul>	Picture tube aperture mask is magnetized	Demagnetize monitor with external degaussing coil. Take care not to magnetize neighboring games. Monitor may be left on or off during this procedure.
<ul style="list-style-type: none"> <li>White areas in center of screen appear tinged with color</li> <li>Object edges have fringe of one or more colors</li> </ul>	Picture tube purity or static convergence is out of alignment	<ol style="list-style-type: none"> <li>Turn on Video Game Machine (VGM).</li> <li>Press and hold TEST MODE to enter Menu System. Select Diagnostic Menu from the Main Menu. Select MONITOR TEST. Perform tests for Crosshatch, Red, Green and Blue screens to find clearest display of problem.</li> <li>Display screen with the most severe problem.</li> <li>Display Crosshatch Screen. Locate purity and static convergence ring magnets on back of monitor neck. Watch screen in mirror. Adjust magnets to minimize problem. Follow instructions from monitor manufacturer.</li> <li>Display Crosshatch Screen. Touch up adjustments while watching screen in mirror.</li> </ol>
<ul style="list-style-type: none"> <li>Picture is dim or faded</li> </ul>	Maladjusted BRIGHTNESS pot or subnormal picture tube emission	<ol style="list-style-type: none"> <li>From Diagnostic Menu select MONITOR TEST.</li> <li>Watch Color Bars screen. Adjust BRIGHTNESS and CONTRAST pots for greatest number of grays. You'll find these pots on Monitor Remote Control Board, behind coin door.</li> <li>If pots have no effect, have service bureau rejuvenate picture tube.</li> </ol>

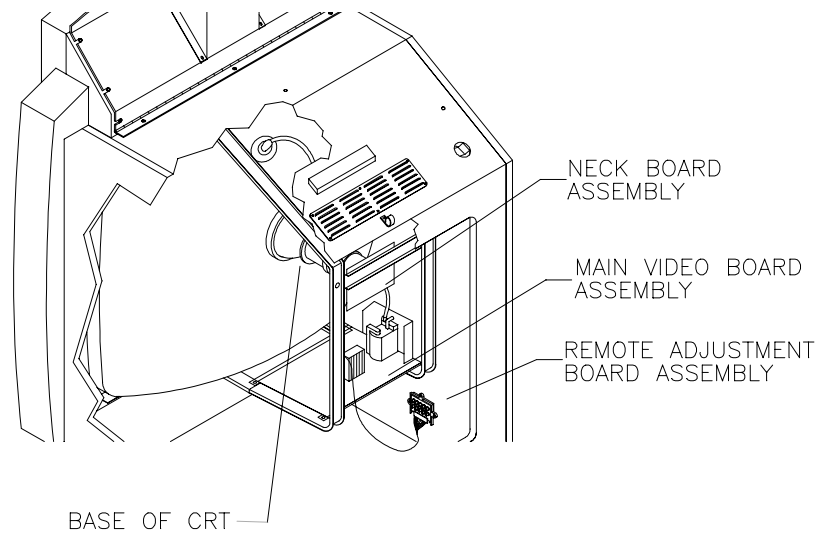
	<p><b>CAUTION</b> Do not remove or install any connector when power is turned on. Installation under power will damage the circuit boards or ROM's and void the warranty.</p>
	<p><b>WARNING: HIGH VOLTAGE.</b> Video Game Machine (VGM) monitors generate and store potentially lethal high voltages. Avoid touching any part of the monitor until power has been off for some time. A picture tube can maintain a hazardous charge for up to several days. Only qualified technicians should service monitors. Turn off the power, unplug the VGM and discharge the CRT before attempting service. Even properly discharged tubes can revert to a highly charged state, <i>without reapplication of power.</i></p>
	<p><b>WARNING</b> In normal operation, the monitor doesn't require isolation from AC line voltage. During bench servicing, you may need to operate the monitor outside the cabinet. If you do, <i>isolate the monitor from line voltage with an isolation transformer.</i></p>



**TYPICAL CUTAWAY REAR VIEW**

	<p><b>CAUTION</b> Do not operate the monitor without its Remote Adjustment Board.</p>
	<p><b>WARNING: HANDLE FLUORESCENT TUBE AND CRT WITH CARE.</b> If you drop a fluorescent tube or CRT and it breaks, it will implode! Shattered glass can fly eight feet or more from the implosion.</p>

## AUDIO TROUBLESHOOTING

Symptom	Cause	Required Action
<ul style="list-style-type: none"> <li>No audio</li> <li>Video is present</li> <li>Video Game Machine (VGM) appears to operate normally</li> </ul>	Improper volume setting	Press and hold TEST MODE switch inside coin door to enter Menu System. Select VOLUME MENU from the Main Menu. Make sure the Attract Music is on (enabled). Verify all volume levels are set well above zero. If necessary, change levels to make game audible.
	Faulty wiring	Turn off power. Assure wiring harness connectors attach and fully seat onto mating board connectors. Verify harness connects to CPU Board. Check audio cable connectors in same way.
	Faulty or obstructed speaker	Remove grilles and inspect speakers. Free speaker cones, terminals, mounting screws and magnets of loose parts or wires.
	Faulty Audio Board	Verify proper operation of Audio Board by placing it in a working VGM.
	Power Problems	Use 20-volt DC setting on digital voltmeter to measure DC voltages present at Power connector pins. Verify +5V, -5V and +12V sources. Refer to Cabinet Wiring Diagram for specific wiring information and voltage limits.
<ul style="list-style-type: none"> <li>Audio is distorted, muffled or has missing frequencies.</li> </ul>	Faulty or improper speaker	<ol style="list-style-type: none"> <li>Turn off power. Remove grilles and check speakers. Verify that speakers are full range (100 to 10,000 Hz response) and rated for at least 20 watts. Woofers must be rated for at least 40 watts.</li> <li>Verify proper speaker operation by placing speaker in question in a working VGM.</li> </ol>
	Faulty wiring	Multiple-speaker installations: Check for reversed wires at one speaker. Weak or low frequencies and thin or hollow sound quality are symptom of incorrectly phased speakers. Sound tests may not detect this condition, but you can hear it during operation.
	Improper Setting	Press and hold TEST MODE switch inside coin door to enter Menu System. Select SOUND TEST from Diagnostics Menu. Increase volume as required. This test will verify some audio circuit functions.
<ul style="list-style-type: none"> <li>Dead sound channel</li> </ul>	Faulty speaker	<ol style="list-style-type: none"> <li>From Diagnostics Menu, choose SOUND TEST. Recheck speakers with audio signals provided by test.</li> <li>Verify proper speaker operation by connecting speaker in question to working Video Game Machine (VGM).</li> </ol>

Symptom	Cause	Required Action
	Faulty circuit board	Run power-up self-test sequence. Note errors found during tests. Compare CPU Board LED's with LED Indicator Status Charts. Note discrepancies.
<ul style="list-style-type: none"> <li>Constant low hum from all speakers.</li> </ul>	Faulty wiring	<ol style="list-style-type: none"> <li>Check cabinet wiring is correct.</li> <li>Verify cabinet wiring provides separate wires (not common return) for each speaker.</li> <li>Check connection of all cabinet ground wires.</li> </ol>
	Faulty power supply	Use 2-Volt AC setting on digital voltmeter to measure voltages at speaker terminals. Any reading indicates unstable supply that may contain ripple or noise.

## MISCELLANEOUS PROBLEM TROUBLESHOOTING

Symptom	Cause	Required Action
<ul style="list-style-type: none"> <li>Marquee lamp is intermittent or non-functional</li> <li>Video Game Machine (VGM) starts and plays normally</li> </ul>	Faulty fluorescent tube	<ol style="list-style-type: none"> <li>Remove fluorescent tube from sockets. If you find cracks or darkened ends, install new lamp. Clean tube.</li> <li>Check continuity of both fluorescent tube filaments.</li> <li>Check lamp ballast is rated for local AC line voltage and frequency.</li> <li>Verify fluorescent tube operates by placing it in working VGM.</li> </ol>
	Faulty lamp fixture	<ol style="list-style-type: none"> <li>Verify lamp pins make good connection with socket contacts.</li> <li>Check the ballast and/or starter are working properly.</li> </ol>
	Faulty wiring	Measure fluorescent lamp AC voltages. Check wiring and connector continuity from AC power chassis to lamp assembly.
<ul style="list-style-type: none"> <li>VGM operates normally</li> <li>Cabinet becomes warm after several hours of use</li> </ul>	Obstructed fan	<ol style="list-style-type: none"> <li>Check bottom and rear of cabinet for blocked airflow.</li> <li>Move VGM away from sources of heat.</li> <li>Turn off power. Remove dust from vent holes with high-power vacuum cleaner.</li> </ol>
	Faulty Wiring	Check fan wiring and connectors.
	Faulty fan	Check operation of all fans.
<ul style="list-style-type: none"> <li>Error messages appear on screen</li> </ul>	Faulty hardware	<ol style="list-style-type: none"> <li>Check any assembly (RAM, ROM, Battery, etc.) identified in error messages.</li> <li>Call your authorized distributor for help with unresolved screen messages.</li> </ol>

# NOTES



## WARNINGS & NOTICES

### WARNING

Use of non-MIDWAY parts or circuit modifications may cause serious injury or equipment damage!

- Federal copyright, trademark and patent laws protect this Video Game Machine (VGM). Unauthorized modifications may be illegal under Federal law. The modification ban also applies to Midway Amusement Games, LLC and VGM logos, designs, publications and assemblies. Moreover, facsimiles of MIDWAY equipment (or any feature thereof) may be illegal under federal law, regardless of whether or not such facsimiles are manufactured with Midway Amusement Games, LLC components.

### WARNING

Prevent shock hazard and assure proper VGM operation. Plug this VGM into a properly grounded outlet. Do not use a cheater plug to defeat the power cord's grounding pin. Do not cut off the ground pin.

### WARNING

A very small portion of the population has a condition which may cause epileptic seizures or momentary loss of consciousness when viewing certain kinds of flashing lights or patterns that are present in our daily environment. These persons may experience seizures while watching some kinds of television pictures or playing certain video games. People who have not had any previous seizures may nonetheless have an undetected epileptic condition.

If you or anyone in your family has experienced symptoms linked to an epileptic condition (e.g. seizures or loss of awareness), immediately consult your physician before using any video games.

We recommend that parents observe their children while they play video games. If you or your child experience the following symptoms: dizziness, altered vision, eye or muscle twitching, involuntary movements, loss of awareness, disorientation, or convulsions, *discontinue use immediately* and consult your physician.

### CAUTION

Information in this manual is subject to change without notice. MIDWAY reserves the right to make improvements in equipment function, design, or components as progress in engineering or manufacturing warrants.

### COPYRIGHT & TRADEMARK NOTICE

You may not reproduce any part of this publication by mechanical, photographic, or electronic means. You may not prepare phonograph recordings of this document. You may not transmit this publication or otherwise copy it for public or private use, without permission from the publisher.

**CRUIS'N EXOTICA is a trademark of Nintendo. © 1999 Midway/Nintendo. All rights reserved. Manufactured and sold by Midway Amusement Games, LLC under license. HUMVEE®, HUMMER®, and the VEHICLE GRILL DESIGN are registered trademarks of AM General Corporation. © AM GENERAL CORP. 1999 all rights reserved. FORD TRADEMARKS USED UNDER LICENSE FROM FORD MOTOR COMPANY. CHEVROLET, CHEVY, CORVETTE (1963,1981 and 1998 models) and VETTE are General Motors Trademarks used under license to Midway Amusement Games, LLC. JEEP and the JEEP grille design, DODGE and PLYMOUTH are registered trademarks of DaimlerChrysler Corporation and are used under license. © DaimlerChrysler Corporation.**

**For Service: Call your authorized Midway Amusement Games, LLC distributor.**

**MIDWAY AMUSEMENT GAMES, LLC  
3401 N. CALIFORNIA AVE. CHICAGO, ILLINOIS 60618-5899 USA  
Visit our Web site at <http://www.midway.com>**