

SUPER CHEXX™



OWNERS AND SERVICE MANUAL INNOVATIVE CONCEPTS IN ENTERTAINMENT INC.

10123 MAIN STREET, CLARENCE, NY 14031

SERVICE: 1-716-759-0360

FAX: 1-716-759-0884

E-MAIL: service@icegame.com

INNOVATIVE CONCEPTS IN ENTERTAINMENT, INC.

COPYRIGHT© 1983 BY INNOVATIVE CONCEPTS IN ENTERTAINMENT, INC.

ALL RIGHTS RESERVED

No part of this publication may be reproduced by any mechanical, photographic, or electronic process, or in the form of a phonographic recording, nor may it be stored in a retrieval system, transmitted, or otherwise copied for public or private use, without the permission of the publisher.

The **SUPER CHEXX**" game play, all graphic designs, this technical manual, its accompanying schematic diagrams, and the trouble-shooting guide are protected by the new Copyright Act of 1976.

This Act provides for increased penalties for violating federal copyright laws. Courts CAN IMPOUND infringing articles while legal action is pending. If infringes are convicted, Courts can ORDER DESTRUCTION of the infringing articles.

In addition, the Act provides for payment of statutory damages of up to \$50,000.00 in certain cases. Infringes may also have to pay costs and attorneys' fees, fines up to \$25,000.00, and face an imprisonment of up to one year.

I.C.E. will aggressively enforce its copyrights against any infringes. WE WILL USE ALL LEGAL MEANS to immediately halt any manufacture, distribution or operation of a copy of any product made by us. Anyone who purchases such copies risks forfeiting such a game.

U.S.A and foreign patents pending.

Published By:

**INNOVATIVE CONCEPTS IN ENTERTAINMENT, INC.
10123 MAIN STREET
CLARENCE, NEW YORK 14031**

Sales: 716 759-0370

Service: 716 759-0360

Email: service@icegame.com

www.icegame.com

TABLE OF CONTENTS

| | |
|------------------------------------|-----------------|
| SUPER CHEXX" Game Play | Page 4 |
| Outstanding Features..... | Page 6 & 7 |
| Programming | Page 9 |
| Game Assembly | Page 10 |
| Game Operation Test..... | Page 10 |
| Maintenance | Page 11 & 12 |
| Troubleshooting and Repair | Page 13 THRU 17 |
| Parts Listing | Page 18 |
| Schematics & Wiring Diagrams | Page 19 THRU 25 |
| Warranty | Page 26 |

SUPER CHEXX" GAME PLAY

The SUPER CHEXX" Hockey game has been designed to resemble "real" hockey action. The object of the game is to out-score your opponent before time runs out. Goals can be scored, with the game continuing, until the "last puck in play" mode begins. When the last puck in play is scored, the game ends.*

Example: If a score is 5-3, the last puck would result in a final score of 5-4 or 6-3.

*The exception to this rule occurs when a final puck would create a tie score.

Example: If the score is 2-1, the last puck might make the score 2-2. The game then automatically goes into a "Sudden Death Overtime" mode and a final tie-breaking puck is ejected. The game will end when the tie-breaking goal is scored.

The National Anthem, as well as the "Boo" sound and the "Ooh's" and "Aah's" add to the excitement of playing SUPER CHEXX". The "Boo" button can be used to eliminate the National Anthem or to "Boo" your opponent.



FEATURES

SUPER CHEXX" is a unique kinetic action hockey game, using state-of-the-art components, electronics, and advanced sound effects designed to closely resemble the action, play, and feel of a real ice hockey game.

BREAK RESISTANT POLYCARBONATE DOME

The cover of this game is made of Lexan and will resist breaking or cracking.

OVERHEAD SCOREBOARD

Scores and shots on goal are automatically tabulated by the main processor unit and displayed here. Other features include a running time clock, digital period display, and a fluorescent light that produces minimal heat eliminating the need for a fan.

UNIQUE SOUND EFFECTS

The sound effects in this game use state-of-the-art components. Along with synthesized organ chants, this game utilizes natural sounds actually recorded at a real hockey game. Cheers can be noted when a goal is scored. "Oh" sounds are produced when a puck enters the goalie's crease. Organ chants indicate period changes, last puck in play mode, and sudden death overtime. A player can actually "Boo" his opponent by pressing the "Boo" button located at each end of the cabinet. Added to all these sounds are a full-time background noise and a National Anthem at the beginning of each game. A player can even bypass the anthem if desired by pressing the "Boo" button.

GEAR / CLUTCH DESIGN

Each player on the game rotates on a 2.4:1 gear mechanism, which utilizes a built-in clutch to allow opposing players to strike or check one another without causing damage to components. This feature also eliminates intentional abuse. The gearing mechanism has been designed to allow a player to rotate at maximum speed with a minimum of effort.



CENTER ICE FACE OFF

This hockey game has a center ice face-off feature to add to the realism of play. The puck is automatically ejected once at the beginning of the game and once after each goal. The puck may be ejected manually by pressing the Boo/Eject buttons.

NEW ROD MATERIAL

Unlike previous games using rods that bend or break easily, SUPER CHEXX" uses rods with a specially developed fiberglass composite and exterior coating to eliminate previous problems. These rods are immune to even torturous abuse. They can bend almost 90 degrees and still return straight time after time.

PLAYERS



LONG STICK PLAYER – 1 PER TEAM



SHORT STICK PLAYER – 4 PER TEAM



GOALIE – 1 PER TEAM

SUPER CHEXX" has realistic three-dimensional decorated players to even further enhance realism and enjoyment of the game.

FEATURES

GAME CABINET

The cabinet is of unitized construction using high quality aluminum for strength, durability, and reliability. Threaded inserts are used throughout the cabinet to make removal and installation of parts in the cabinet fast and easy.

GAME BASE

The base design is a first in the game industry, using a one-piece high impact plastic material versus conventional wood or particleboard cabinetry. It is impervious to liquid spills as well as many other typical abuses to which games are subjected. The coloring has been molded into and throughout the base, eliminating the effect of scratches that harm the appearance and beauty of the game.

ADJUSTABLE TIME AND VEND PRICE

The time and vend price of the game can be adjusted individually by switches on the main PC board. Time can be set for two, three, four, or five minutes. The vend price can be adjusted for \$.25, \$.50, \$.75 or Free Play. Any combination of time and price can be used.

ELECTRONICS ACCESS

All of the SUPER CHEXX" electronics are located on a single PC board just inside the coin door. All IC's are readily accessible and mounted in high quality sockets simplifying repairs.

SCOREBOARD ELECTRONICS

The scoreboard electronics, designed with state-of-the-art circuitry, are very reliable. If any repair should be necessary, the scoreboard can be replaced in less than (5) minutes, eliminating costly down time.

SPEED OF PLAY

The play of the game is extremely fast. A unique ramp construction eliminates dead spots and a special finish on the highly polished playfield enhances the puck action. The gearing ratio (described earlier), used for fast and effortless play and rotation, provides for greater speed and accuracy when shooting the puck.

QUICK ASSEMBLY

The game, designed in two pieces with an upper and a lower half, can be assembled and connected in less than (5) minutes.

OVER / UNDER COIN DOOR

An industry standard over / under coin door is used in the SUPER CHEXX" game.



PRESS THE PROGRAM (PGM) BUTTON OF THE MAIN P.C. BOARD.
(THIS IS THE LEFTMOST OF THE 4 BUTTONS).

PRESS THE SELECT (SEL) BUTTON TO ADVANCE THROUGH THE
VARIOUS PROGRAMMING OPTIONS.

PRESS THE STEP (STEP) BUTTON TO CHANGE THE VALUE OF THAT
PARTICULAR PROGRAMMING OPTION.

WHEN FINISHED, PRESS THE PROGRAM (PGM) BUTTON TO
RETURN TO GAME PLAY MODE.

note: pressing the start button will play 1 game without
advancing any counters. (or dispensing any tickets from the
optional ticket dispenser)

GAME OPTIONS

- 1. COIN 1 (COINS PER CREDIT) SET THIS VALUE FOR HOW MANY COINS IT WILL TAKE FOR 1 CREDIT.**
- 2. COIN 2 (COIN 1 EQUIVALENT) SET THIS VALUE TO 1 IF YOU WISH THE VALUE TO BE THE SAME AS COIN 1 (IF YOU WISH THE VALUE TO BE TWICE AS HIGH, SET TO 2. IF YOU WISH THE VALUE TO BE THREE TIMES AS HIGH, SET TO 3, ETC&).**
- 3. TIME UNITS PER PERIOD SET THIS VALUE TO 20 FOR HOCKEY, OR 15 OR 30 FOR SOCCER.**
- 4. TIME PER PERIOD SET THIS NUMBER FOR THE ACTUAL AMOUNT OF SECONDS PER PERIOD. MULTIPLY THE NUMBER OF PERIODS BY THE NUMBER OF SECONDS YOU CHOOSE FOR OVERALL GAME TIME. EXAMPLE: 60 SECONDS X 3 PERIODS (HOCKEY) - 3 MINUTE GAMES.**
- 5. NUMBER OF PERIODS SET THIS NUMBER TO 3 FOR HOCKEY, OR 2 OR 4 FOR SOCCER.**
- 6. ANTHEM SET THIS VALUE TO 1 FOR THE CANADIAN ANTHEM, OR 0 FOR THE U.S.A. ANTHEM.**
- 7. AWARDS PER GAME SET THIS VALUE FOR THE NUMBER OF TICKETS YOU WANT DISPENSED AT THE END OF THE GAME.**
- 8. ATTRACT MODE INTERVAL SET THIS NUMBER FOR THE AMOUNT OF TIME BETWEEN ATTRACT MODE SOUNDS. SELECTING 0 WILL TURN THE ATTRACT MODE OFF.**

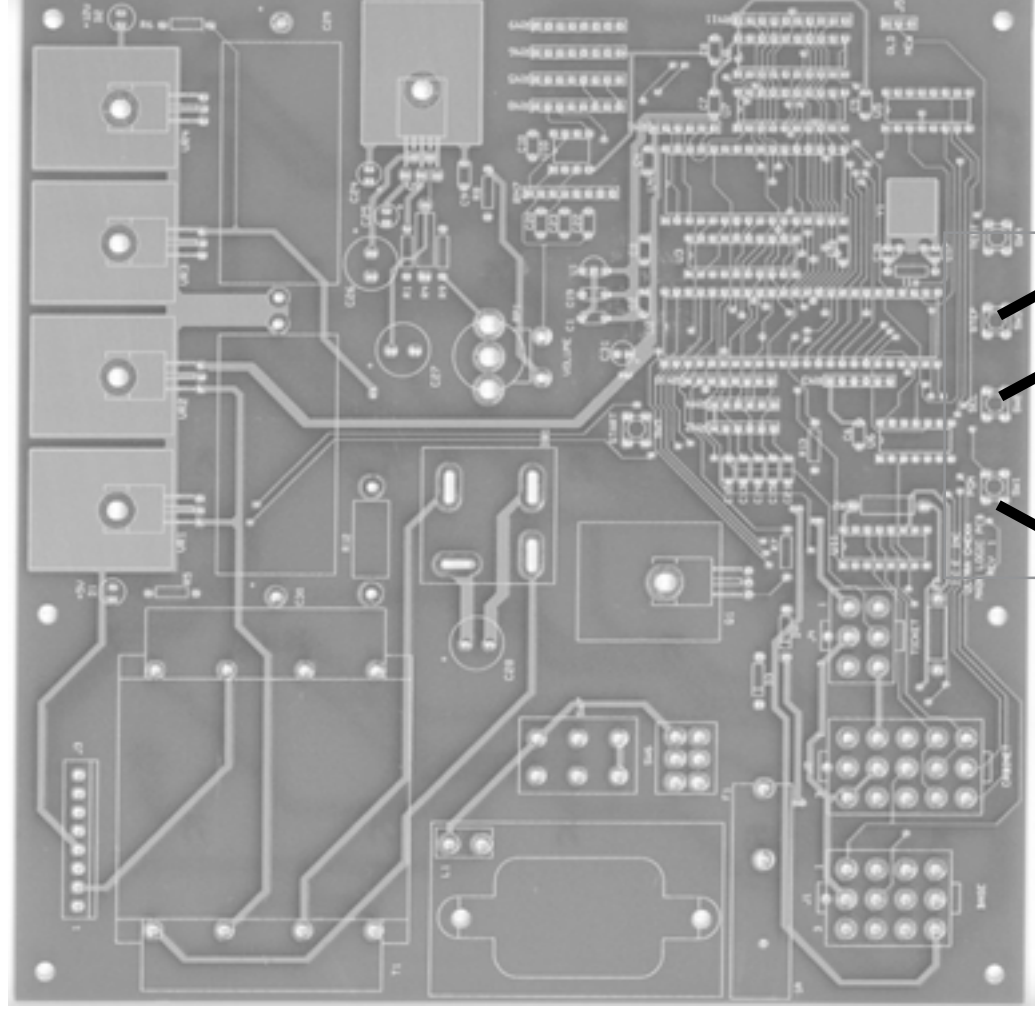

PROGRAM BUTTON

STEP BUTTON

SELECT BUTTON

GAME ASSEMBLY

These steps should be followed for initial installation as well as any time the game is dismantled and moved to a new location.

INSPECT INSIDE OF BASE

Check for loose parts or foreign material in bottom.

Inspect harnessing to speakers, coin door and coin meter.

Inspect main PC Board for damage and familiarize yourself with the 15-pin cabinet harness connector and the 8-pin header for the scoreboard ribbon cable.

Place cabinet on Base oriented with hinge side of cabinet opposite the coin door side of the Base.

Align the two so that the threaded cabinet mounting inserts are visible through the access holes and the mounting holes in the Base.

Install 4 Allen Head mounting bolts with fender washers and tighten with provided T-handle wrench.

Connect 15-Pin Connector and Ribbon Cable connector to main PC Board. **The locking edge of the ribbon cable connector should face the rear of the base. Do not force or connect backwards or damage will occur.**

Plug game into 110 (optional 220) volt GROUNDED AC outlet and turn on PC Board mounted power switch.

Warning: Failure to use a 3-prong grounded outlet will void your warranty and may cause harm to the game, yourself, and others.

Coin-up game and check for proper operation.

Finally, make sure your game is clean. A clean game looks good, gets more play, and makes more money than a dirty game.

GAME OPERATION – TEST

IMPORTANT: IF THE GAME FAILS TO PERFORM THE FOLLOWING TESTS AS DESCRIBED, REFER TO THE TROUBLESHOOTING SECTION.

Before starting a game, check to see that all players rotate smoothly and that all rods move in and out freely.

NOTE: THE GEAR BOXES REQUIRE 10 – 20 GAMES TO FULLY BREAK IN. SLIGHT RESISTANCE WHEN ROTATING THE PLAYERS ON A NEW GAME IS NORMAL.

Insert the proper number of coins to start game. The National Anthem will begin and upon completion, the puck will eject from the ejector chute. Shoot the puck in each net several times to ensure proper operation of the ejector.

Each time the puck enters the net; the score indicators on both sides of the scoreboard should indicate the goal scored. Continue scoring until the game ends, checking the score indicators for proper operation. Check to see that the score indicators on both sides of the scoreboard are working correctly.

Restart the game. Press the Boo/Eject button to ensure the National Anthem is bypassed. The puck should eject.

After the puck ejects, press the Boo/Eject buttons on both ends of the game to ensure the “Boo” sound is heard and eject Solenoid is activated.

Run the puck through each goal crease. The “Oh” sound should be heard as the puck passes through the crease. Note that a shot on a goal has been registered.

MAINTENANCE

All parts in the SUPER CHEXX" Hockey Game have been manufactured to the highest standards possible. The following maintenance should be performed as recommended to assure optimal performance and longevity of the game.

WARNING: THIS GAME DOES NOT REQUIRE ANY LUBRICATION. USE OF ANY OILS OR GREASE MAY VOID YOUR WARRANTY.

Most mechanical maintenance jobs, when required, will necessitate removal of the dome and / or ice surface. In all cases, when the ice surface must be removed, follow the ice surface removal procedure as given.

PUCK

Inspect the puck for large gashes, which may impede a smooth rolling action down the puck ramps. Replace if necessary.

PUCK RAMPS

Periodically check the puck ramps for dirt accumulation and / or other objects or materials that may cause the puck action to slow down. To clean the ramps, remove the goalies. Slide all players to center ice (this saves time, as all the players and ice surface do not have to be removed). Bend up the ice on either end and remove the nets. Clean out the tracks and reassemble.



SCOREBOARD LIGHTS

Replacement is advised when necessary. Remove the four screws on the light diffuser and pull out the bulb. Insert the new bulb and reassemble.

NOTE: TIE WRAPS HAVE BEEN USED TO SECURE THE FLOURESCENT LIGHT AGAINST SHIPPING DAMAGE AND ABUSE ON LOCATION. IT IS RECOMMENDED THAT THESE BE REPLACED AFTER A NEW LIGHT IS INSTALLED.

COIN MECHANISMS

Mechanisms should be cleaned and adjusted when necessary. Follow the manufacturer's instructions on adjustment and maintenance.

PLAYER WASHERS



These washers, located over each gearbox, serve to keep the players shafts in place in their gearboxes.

Extreme care should be exercised when pulling out or pushing in players because a washer that falls into a track can be bothersome to remove. To help eliminate this problem, push all the rods all the way in, and pull the player straight out. When pushing a player back in, be sure the gearbox is lined up with the shafts. If not, slowly rotate the rod while pushing down on the player.

NOTE: WASHERS SHOULD BE REPLACED WHEN WORN TO THE POINT THAT THEY CAN NO LONGER HOLD THE PLAYERS IN. AFTER PLAYERS ARE INSERTED, PULL UP GENTLY TO TEST THE STRENGTH OF THE WASHERS.



SOUND EFFECTS

Periodically test the sound effects, sensors, and the "Boo" button to ensure the proper functions. Test for National Anthem bypass.

MAINTENANCE

ICE SURFACE

The ice surface should be cleaned as needed, using Windex", Fantastic", or a comparable product. Apply liberally to a lint-free cloth, wipe surface thoroughly, and let dry. For a "faster" ice surface, dust lightly with Pledge" and let dry.

DOMES

The Lexan dome should be cleaned as needed, using a furniture polish type of cleaner. Apply to a lint-free cloth and wipe dome thoroughly.

NOTE: PLEDGE" IS RECOMMENDED. ALWAYS TEST THE CLEANER YOU INTEND TO USE ALONG THE FLANGE TO MAKE SURE THE CLEANER WILL NOT HARM THE DOME FINISH. TO REMOVE SCRATCHES, A SPECIAL SCRATCH REMOVER FORMULATED FOR LEXAN SHOULD BE OBTAINED.

PLAYERS

Periodically inspect the players for appearance or possible damage. Replace when necessary.

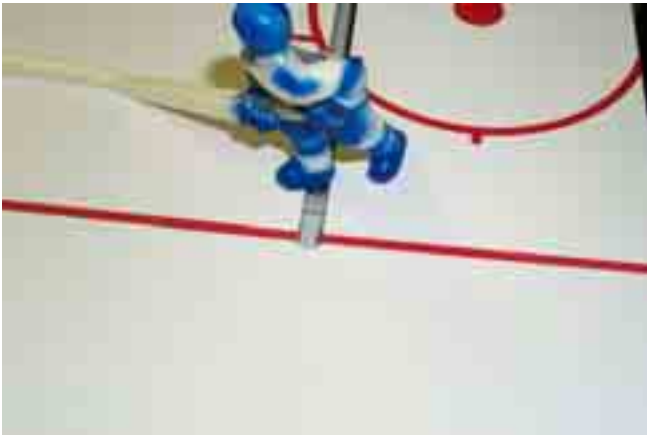

EJECTOR MECHANISM

Periodically test the mechanism by scoring goal and observing puck ejection. If puck fails to eject, does not clear ice surface, or ejects with excessive lean in one direction, the mechanism is not working correctly. Open the dome and remove the ice surface.

NOTE: BE CAREFUL NOT TO LOSE THE FLAT WASHERS.

Start the game and observe operation. Check for foreign particles under the ejector wire. The entire bracket assembly can be bent to correct excessive lean in one direction. Be sure all parts work freely. Check by pushing the solenoid plunger only, to see that the ejector lifts up about 3/8" from the cabinet bottom. If more or less movement is noted, the ejector wire can be bent forward or backward where it meets the plunger to obtain proper operation.

Excessive random angle ejections can be straightened by tightening the pivot screw. An ejector that sticks in the up position can be fixed by loosening the pivot screw.

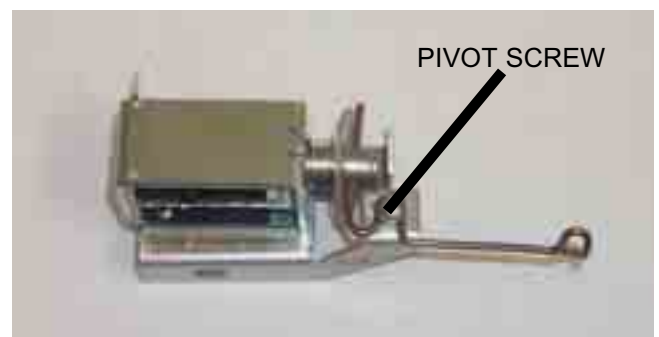
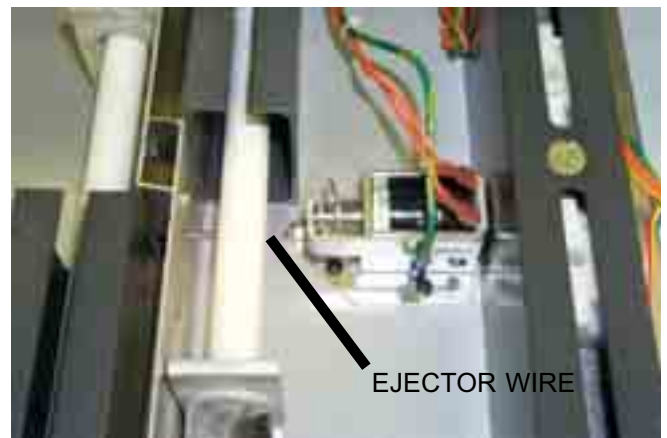

MAINTENANCE

GEARBOXES

Gearboxes should be inspected periodically to ensure smooth operation. Gearbox tracks should be kept as clean as possible. If a gearbox seems to rotate stiffly, first check to see that a rod collar is not pushed up tightly against it (this can happen if a grip comes off a rod and a gearbox hits a solid object, usually on defensemen). Back off a collar from a gearbox by loosening, moving, and retightening.

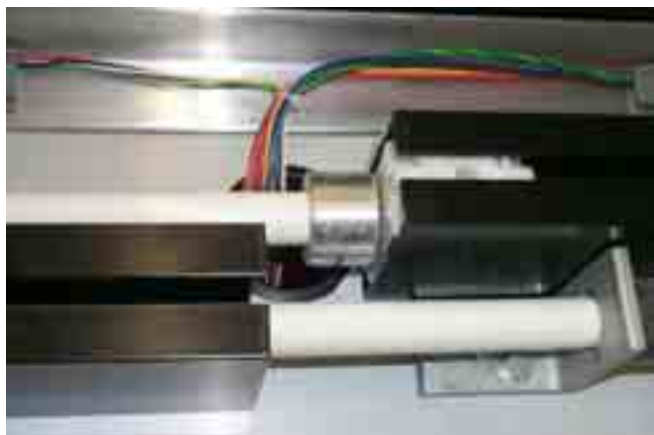

NOTE GEARBOXES ARE LUBRICATED FOR LIFE AND SHOULD NOT BE OILED OR GREASED.

ROD BEARINGS

Check once a year for excessive wear. Replace when necessary.

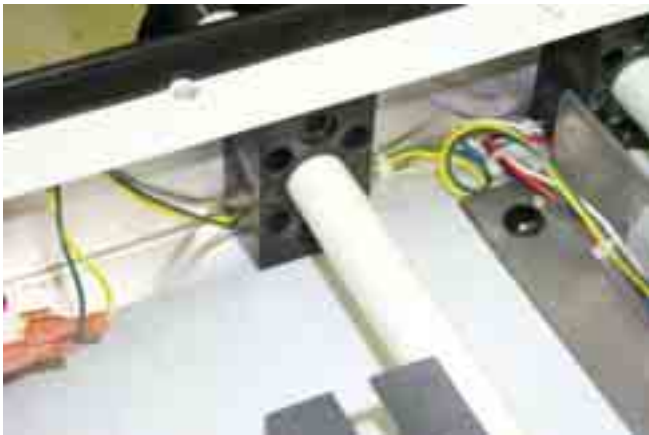

PUCK CHUTE

Clean periodically to ensure a good sliding surface. Check for cracks. Small cracks can be glued with a C/A adhesive. Large cracks require changing the part.



GOALIE MECHANISMS

Check for smooth operation.

RODS

Check periodically for cracks and gouges. Replace if necessary. Clean Mineral Spirits or Paint Thinner. Do not allow cleaner to contact the Dome, as it will damage the Dome.

TRACKS

Check periodically. Clean by pushing a rag along the length of the track.



SENSORS

These should be tested periodically by moving the puck over the "Oh" sensors and through the score sensors.

TROUBLESHOOTING AND REPAIR

PUCK WILL NOT EJECT

For some ejection problems the ice surface may have to be removed.

1. Opening the dome and sliding all of the players to the center ice can correct dirt in the puck ramps. Next, remove the goalies one at a time, bend up the ice surface and clean the ramps. Assemble in the reverse order.

A leaning puck ramp can be corrected by observing which way the puck leans as it rolls down the ramp and bending the ramp to one side or the other, back by the net chute assembly.

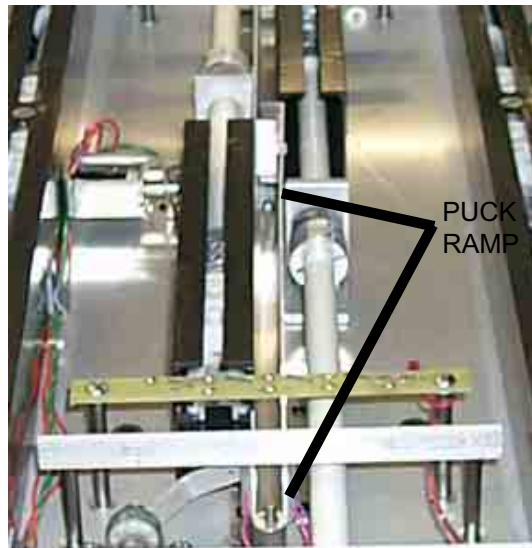

3. A puck ramp may become pushed up during shipping or moving. Just push it back down in the retainer/chute with a pencil or screwdriver.
4. A unique electronic circuit incorporated on the main PC Board prevents the eject solenoid from burning out. If a solenoid problem is suspected, check for a pulse of about 12 volts at the solenoid. Then remove the wires to the solenoid and check that the coil is not open or shorted. A good solenoid will read between 3–4 ohms.

NOTE: REPLACE THE SOLENOID ONLY AFTER DETERMINING WITH AN OHM/VOLT METER THAT THE SOLENOID WAS RECEIVING POWER.

PUCK TAKES TWO OR THREE TIMES TO EJECT

A puck hitting the ice surface can be corrected by first making sure the ice surface is in place. If it is in place, observe which way to bend the retainer chute assembly to line up with the opening in the surface.

To determine if the ejector wire is misaligned, first remove the ice surface and then start the game. Look straight down the ejector chute and observe how the puck ejects. If the puck consistently hits one side of the chute, the ejector wire should be adjusted. Refer to the maintenance section for specific directions, under "Ejector Mechanism."

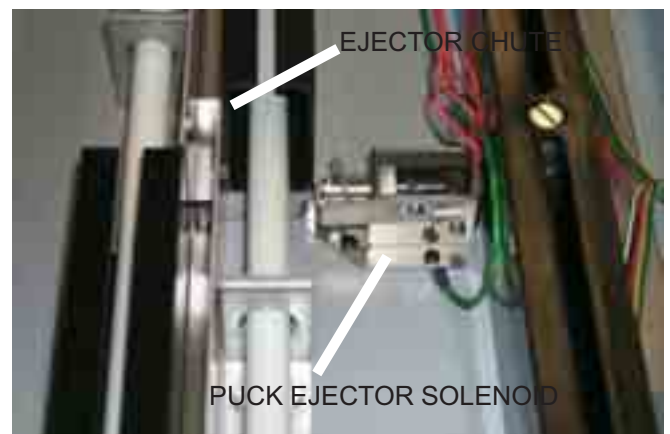
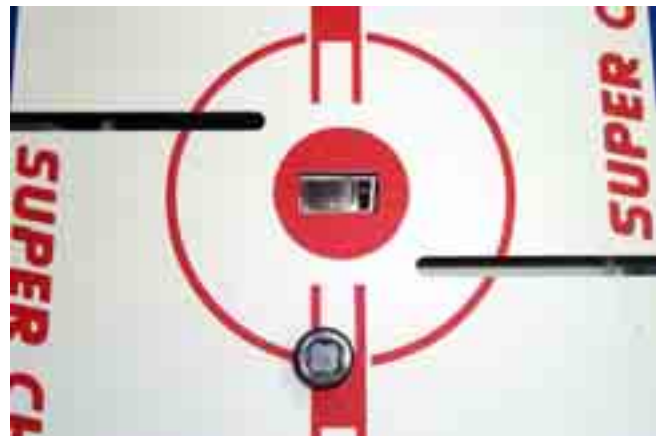

TROUBLESHOOTING AND REPAIR

GEARBOX IS DIFFICULT TO TURN

1. A gearbox-coupling collar may have been forced against a gearbox causing uneven or difficult turning. The usual cause for this is a handle grip coming off a rod and allowing the gearbox to hit either another gearbox or a cabinet end. To repair, simply loosen the collar and back it away from the gearbox between 1/32" and 1/16".

PLAYER ROD & GEAR BOX SHAFT MUST MEET IN THE CENTER OF COLLAR SLOT



Retighten.

2. Gear teeth being stripped out will generally cause binding at certain points of rotation. This situation should not occur until many games have been played. However, to check for bad gears, first remove the gearbox from the game. Loosen the gearbox collar and slide out the gearbox. If teeth on gears are worn out, replace the gearbox.
3. A worn gear bearing can cause a gearbox to work improperly. If you suspect a gear problem, first remove the gearbox from the game. If no problems are visible, disassemble the gearbox. If a worn bearing is found, replace the gearbox.

GAME LIGHTING DIM

1. The scoreboard bulb may be burned out. Open the dome and see if the bulb appears to be burned out while the game is plugged in. Unplug the game. Remove the screws holding the right diffuser in place. Replace the light bulb and reassemble.
2. Very low AC power will cause poor lighting. To test, use a voltmeter on the suspect line to determine voltage. A CHEXX" game hooked up to a line with too many other games may experience this difficulty. Move the game to its own AC line if this problem is experienced.

NO LIGHT IN GAME

1. The light bulb may be burned out. Open dome see if bulb is burned out. Replace if necessary.
2. A loose scoreboard connector is not likely to affect the bulb without affecting some other component in the scoreboard. However, make sure the connectors are firmly seated.

PLAYERS RUN INTO THE END OF THEIR SLOTS

1. A rod collar slipping may cause a player to hit the end of a slot in an ice surface. Open the game and rotate the rod until you can see the rod and gearbox touch, through the slot in the collar. If the rod and the gearbox do not touch, loosen the collar make sure the rod and gear box coupler touch, and retighten the gearbox. Be sure to leave 1/32" to 1/16" between the collar and the gearbox body.

SCORE INDICATORS DO NOT WORK PROPERLY

1. A bad LED may cause malfunction. Replace the scoreboard and run electronic tests on the faulty unit.
2. A bad scoreboard chip may cause indicator malfunction. Replace the scoreboard and run electronic tests on the faulty unit.
3. A loose connection may cause malfunction. Check and repair as necessary.

GAME LOSES PLAY SEQUENCE. GIVES FALSE SCORE, WILL NOT START WHEN MONEY IS INSERTED

1. Although game is protected against static electricity, an unusually large shock will cause the microprocessor to lose sequence. To correct the problem, turn off power and turn it back on to reset electronics.
2. A game plugged into an ungrounded outlet has no protection from static electricity. A large enough shock may destroy the IC chips. Electronic tests may be run to determine the fault. Repair as necessary .

TROUBLESHOOTING AND REPAIR

COINS NOT REGISTERED CORRECTLY

1. A bad micro-switch may be a problem due to internal failure. Test with an ohmmeter. Replace if necessary.
2. Loose connections may cause money to be registered improperly. Check the connectors from the coin mechanisms, as well as the connectors on the main PC Board. Repair if necessary.
3. A bad capacitor (CZ5) on the main PC Board may cause bounce problems with the micro-switch. Run electronics tests to determine the problem.

NO "OH" SOUNDS OR REPEATED "OH" SOUNDS

1. Short or open circuits in the harness or one of the reed switches on the "Oh" sensors are the most common problems. Repair as necessary.
2. A bad IC chip on the main PC Board may cause problems. Run electronics tests. Repair defective components.

SCORE IS NOT REGISTERED—NO CHEER

1. A bad Reed Switch may cause a goal not to register. Disconnect and test with an ohmmeter. Replace if defective.

A bad connection could be a problem. Check associated harnessing and connectors with an ohmmeter.

SCORE IS NOT REGISTERED—GAME CHEERS

1. A scoreboard connector may be loose or bad. Repair or correct as necessary.
2. A bad scoreboard IC chip may be a problem. Replace the scoreboard and run electronics tests to determine the problem.

SCORE AND CHEERING KEEPS REPEATING FOR ONE TEAM WITH NO GOALS ACTUALLY BEING SCORED

1. A Reed Switch shorted to the cabinet will cause this problem. Usually an exposed wire touching the cabinet will be the cause of the problems.
2. A Reed Switch, always closed, can be tested by first disconnecting it from the board. Use an ohmmeter to see if the switch is always closed. If it is, replace the score Reed Switch.

SOUND GOES LOW OR GOES ON AND OFF

1. Check the audio IC chips on the main PC Board. Replace any defective parts.
2. A faulty volume control is a possible cause for intermittent sound. Rotating the volume control will usually show a problem. Many times, the problem can be corrected by cleaning with a commercially available switch cleaner.
3. A bad speaker connection to the main PC Board may be the problem. Check and repair as necessary.

PLAYERS RUB ON THE SIDES OF THEIR SLOTS

1. On rare occasions a track may become bent, forcing the player to work improperly. If, when the ice surface is properly located, you can see the top of an aluminum track, the track must be bent.



NOTE: ALUMINUM TRACK IS **NOT** VISIBLE IN PHOTO.

Use a large screwdriver or other suitable object, and gently pry in the desired direction to obtain clearance. Check for smooth operation.

NOTE: BE SURE NOT TO GOUGE THE SIDE OF THE CHANNEL WHEN PRYING. A RAG SHOULD BE WRAPPED AROUND YOUR SCREWDRIVER.

TROUBLESHOOTING AND REPAIR

TOP CABINET ASSEMBLY WITH ICE SURFACE & PLAYERS INSTALLED



PLAYER NUMBERING AND LAYOUT

| | | | |
|------------------|-----------------|-----------------|------------------|
| | 18 Long | | 12 Short |
| | 6 Short | | 4 Short |
| 30 Goalie | 14 Short | 14 Short | 30 Goalie |
| | 4 Short | | 6 Short |
| | 12 Short | | 18 Long |

TROUBLESHOOTING AND REPAIR

TOP CABINET ASSEMBLY WITH ICE SURFACE & PLAYERS REMOVED



PARTS LIST

745 DECAL (CABINET) (NEW STYLE)
 1002X ROD COLLAR (LONG)
 1003X ROD COLLAR (SHORT)
 1004X GOALIE TRACK
 GOALIE SWING ARM
 1007X PLAYER TRACK 1 & 8 EACH
 1008X PLAYER TRACK 2 & 7 EACH
 1009X PLAYER TRACK 3 & 6 EACH
 1010X PLAYER TRACK 4 & 5 EACH
 1012 CTR. EJECT RETAINER CHUTE
 1013 PUCK RAMP ASSY.
 1014 SCORE SENSOR BRACKET
 SOLENOID STOP BRACKET
 1016 DOME HINGE
 1018 GOALIE BEARING ASSY.
 1019 CENTERMAN STOP
 EJECT SOLENOID BRACKET
 243X DISPLAY PCBA
 248 PL 7 TRANSFORMER
 249 PL 7 BULB
 PL 7 SOCKET
 2001 SCOREBOARD PCBB
 2003 BOO BUTTON
 2007 SPEAKER
 SOLENOID
 SC2070X MAIN PCBA
 2071 TRANSFORMER
 IC EPROM
 2368 IC MICROPROCESSOR
 341 SCOREBOARD HOUSING
 342 SCOREBOARD COVER
 3001 DOME
 3002 CHUTE/NET ASSY.
 3002A NET CURTAIN
 3004 NET MOUNT TUBE (LONG)
 3005 NET MOUNT TUBE (SHORT)
 3006 GOALIE BLOCK
 3007 GOALIE TRACK MNT. TUBE
 3008 PLAYER LOCK WASHERS
 3009 BUMPER STANDOFF
 3010A GOALIE KNOB & ROD ONLY
 3010X GOALIE ROD W / SWING ARM.
 3011 "D" FLECTOR
 3012X GEARS
 3013X PUCK ASSY.
 3014 EJECTOR ARM BUSHING
 3016 ROD BEARING
 3017X GRIP BUMPER ASSY.
 3018 NET RAMP
 3020 ROD GRIPS
 SK321 PLAYER ROD 1, 5, 6, 10 WINGERS
 SK322 PLAYER ROD 2, 4, 7, 9 DEFENSEMEN

3025X ICE SURFACE ASSY.
 3035 PLAYER ROD WASHERS
 3036 DOME WASHERS
 4002 GOALIE BUMPER STOPS
 4003 CABINET GASKET PER PC. (10 FT.)
 4004 COLLAR RUBBER
 5003 SPEAKER GRILL
 5005 EJECTOR ARM
 5011 EJECT. SOLENOID SPRING
 6001 DOME FASTENER
 6001B DOME BOLT ALLEN WRENCH
 6006 1/4 - 3/8 SHOULDER BOLT
 6010 GOAL. CLUTCH-O-RING
 6011 GOAL. ROD WASHER
 6021 SOLENOID RIVET
 6024 DEFENSEMAN STANDOFF BOLT
 6025 VINYL STANDOFF TUBING
 6036 COLLAR ALLEN WRENCH
 COLLAR SCREW
 6067 FENDER WASHER
 COTTER PIN
 6287 BASE TO CABINET BOLT 5/16-18 X 1 3/4
 6706X OH SENSOR ASSY. W/REED SWITCHES
 6707X SCORE/EJECT SENSOR ASSY.
 6707A 1" REED SWITCH-SCORE/EJECT
 6711X RIBBON CABLE ASSY.
 7001X GOALIE & BLOCK ASSY. WHITE/BLUE
 7002X GOALIE & BLOCK ASSY. WHITE/RED
 7005A PLAYER (LS/SC) WHITE/RED
 7007B PLAYER (LS/SC) WHITE/BLUE
 7008A PLAYER (SS/SC) WHITE /RED
 7010B PLAYER (SS/SC) WHITE/BLUE
 7025B DECAL (BOO/EJECT) BLACK
 7030X GIGARETTE DECAL
 7118 DECAL (BASE) (NEW STYLE)

4 | 3 | 2 | 1

D | D

#279X-BASE HARNESS
 **DOES NOT INCLUDE POWER CORD.

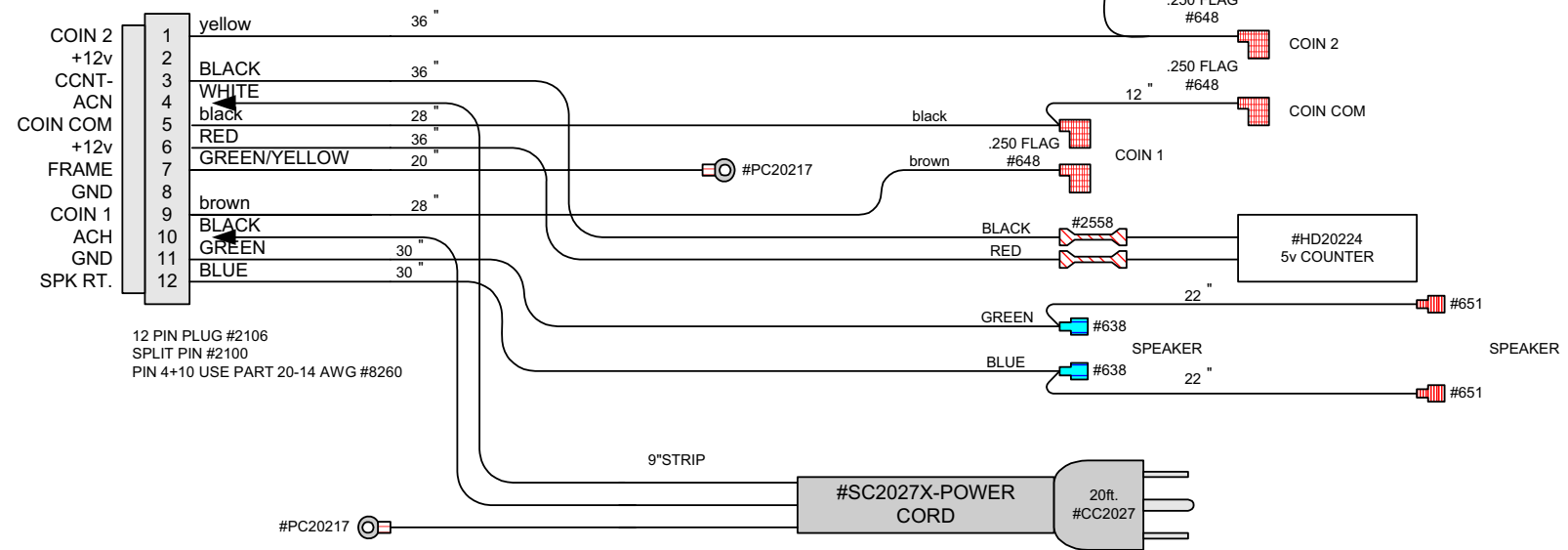

12 PIN PLUG #2106
 SPLIT PIN #2100
 PIN 4+10 USE PART 20-14 AWG #8260

C | C

B | B

A | A

| | | |
|-----|---|----------|
| QTY | 1 | PER GAME |
|-----|---|----------|

| | | | | | | | |
|-------------|--|--------|--|---------------------|--|-------------|--|
| TITLE | | | | SUPER CHEXX | | | |
| DESCRIPTION | | | | #279X-BASE HARNESS | | FILENAME | |
| | | | | #SC2027X-POWER CORD | | SC_VSD..VSD | |
| | | | | DRAWN BY | | CHERYLZ1 | |
| DATE | | 3/1/00 | | REVISED | | 6/27/01 | |
| | | | | PAGE | | 1 OF 4 | |

4 | 3 | 2 | 1

#278X-CABINET HARNESS

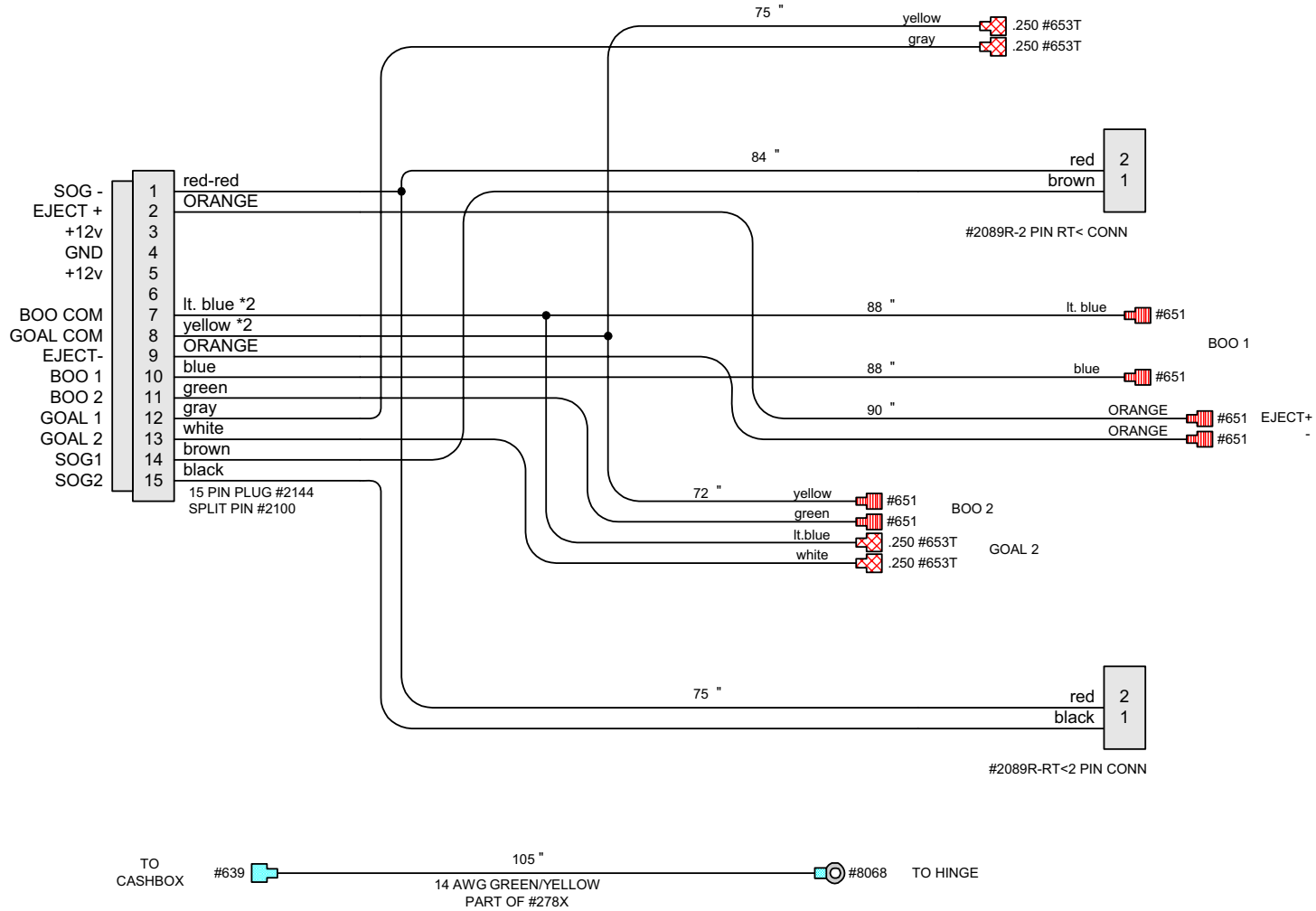

| | | | |
|-------------|--------|-------------|-------------|
| TITLE | | SUPER CHEXX | |
| DESCRIPTION | | FILENAME | SC_VSD..VSD |
| | | DRAWN BY | CHERYLZ1 |
| DATE | 3/1/00 | REVISED | 6/27/01 |
| | | PAGE | 2 OF 4 |

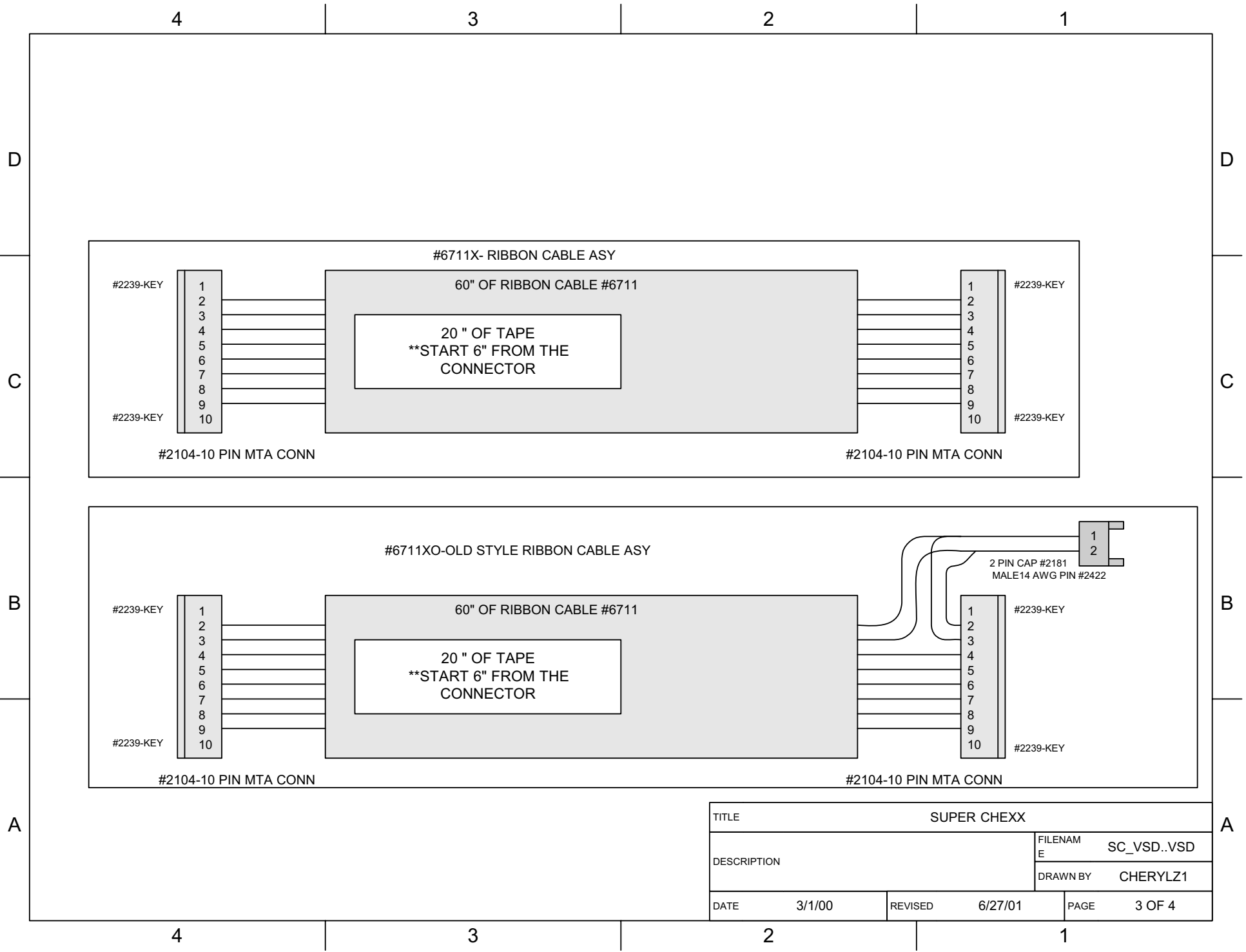

| | | | |
|-------------|--------|-------------|-------------|
| TITLE | | SUPER CHEXX | |
| DESCRIPTION | | FILENAME | SC_VSD..VSD |
| | | DRAWN BY | CHERYLZ1 |
| DATE | 3/1/00 | REVISED | 6/27/01 |
| | | PAGE | 3 OF 4 |

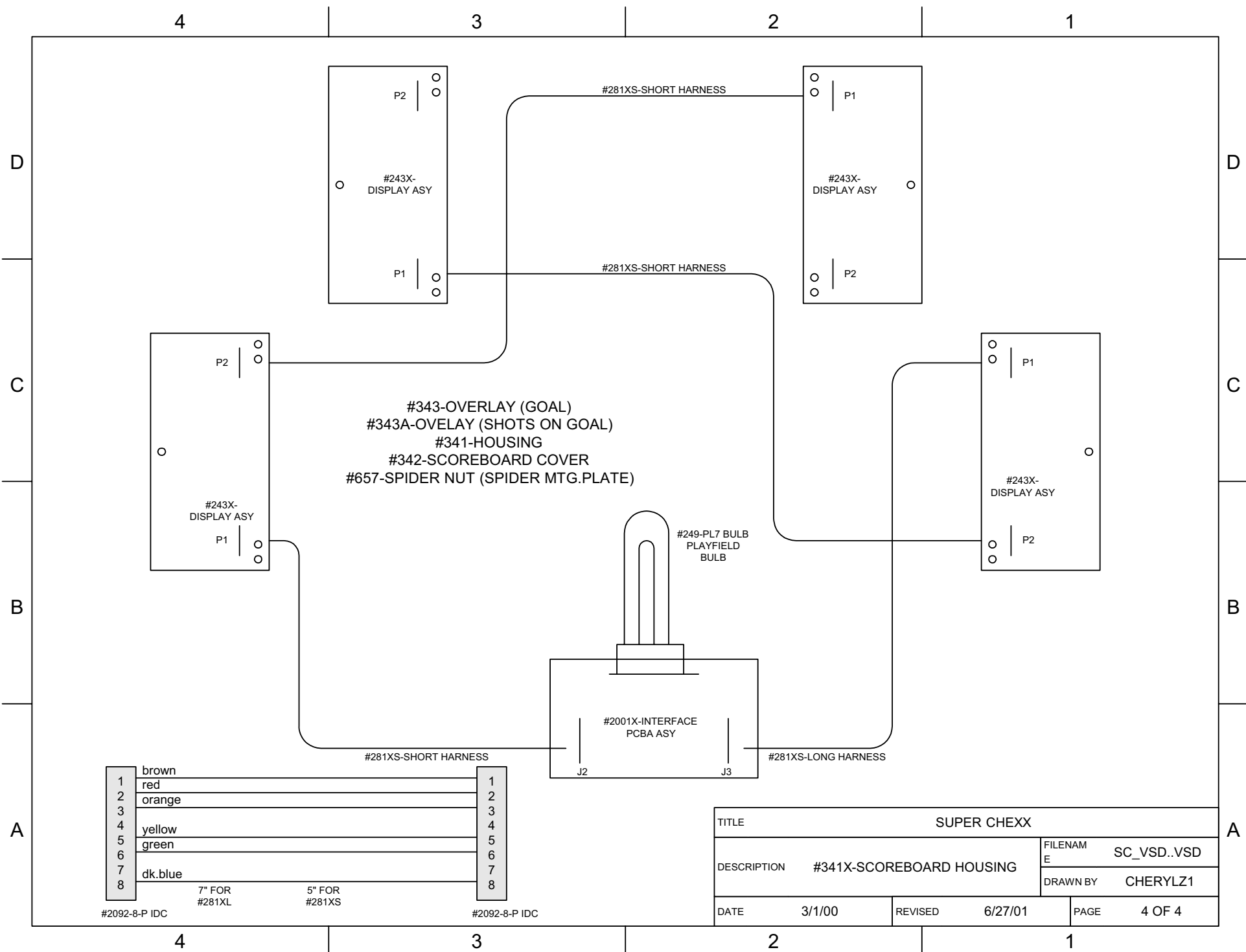

| | | | |
|-------------|--------------------------|-------------|-------------|
| TITLE | | SUPER CHEXX | |
| DESCRIPTION | #341X-SCOREBOARD HOUSING | FILENAM | SC_VSD..VSD |
| | | E | |
| | | DRAWN BY | CHERYLZ1 |
| DATE | 3/1/00 | REVISED | 6/27/01 |
| | | PAGE | 4 OF 4 |

Warranty

I.C.E warrants all components in the **SUPER CHEXX**" game to be free of defects in materials and workmanship for a period of ninety days from the date of purchase.

This warranty does not cover items damaged due to normal wear and tear, subjected to abuse, improperly assembled by the end user, modified, repaired, or operated in a fashion other than that described in the service manual.

If your **SUPER CHEXX**" game fails to conform to the above-mentioned warranty, I.C.E.'s sole responsibility shall be at its discretion to repair or replace any defective component with a new or remanufactured component of equal to or greater O.E.M. specification.

I.C.E. will assume no liability whatsoever, for costs associated with labor to replace defective parts, or travel time associated therein.

I.C.E.'s obligation will be to ship free of charge, replacement parts by U.P.S. Ground, U.S. mail, or other comparable shipping means. Any express mail or overnight shipping expense is at the cost of the purchaser.

Products will be covered under warranty only when:

- The serial number of the game with the defective parts is given.
- The serial number of the defective part, if applicable, is given.
- Defective parts are returned to I.C.E., shipping pre-paid, in a timely fashion, if requested by I.C.E.
- A copy of the sales receipt is available as proof of purchase upon request of I.C.E.

I.C.E. distributors are independent, privately owned and operated. In their judgment, they may sell parts or accessories other than those manufactured by I.C.E. We cannot be responsible for the quality, suitability, or safety of any non-I.C.E. part, or any modification, including labor, which is performed by such a distributor.