

注1. MATEはユニバーサルメイトロックコネクタ。指定なきコネクタはミニユニバーサルメイトロックコネクタを示す。
 注2. プラグコネクタにはソケットコネクタ。キャップコネクタにはピンコネクタを使用する。
 注3. 指定なき太線はAWG18。細線はAWG24を示す。
 注4. ()のつく線は、付属線を示す。

- 線色対照表
- BK
 - BL
 - BW
 - GN
 - GY
 - LB
 - OR
- /Wのつく

NO.	NAME OF PART	QTY	MATERIAL	FINISH	NOTE
-----	--------------	-----	----------	--------	------

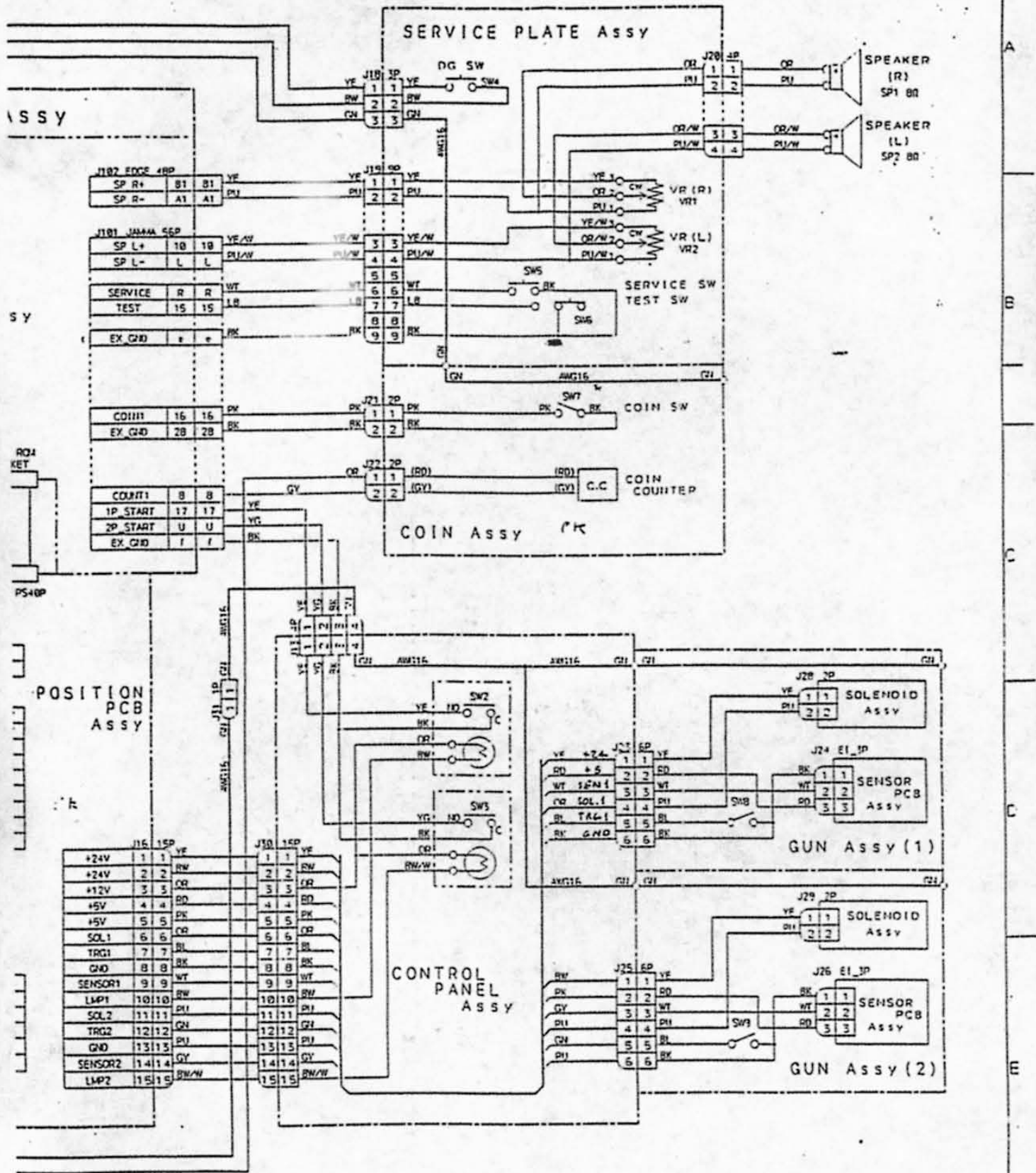

- ACK) PK - ピンク (PINK)
- UE) PU - ムラ (PURPLE)
- ROWN) RD - アカ (RED)
- REEN) WT - シロ (WHITE)
- RAY) YE - キイ (YELLOW)
- IGHT BLUE) YG - キミドリ (YELLOWISH GREEN)
- RANGE)

色のスパイラルワイヤー モデル。



DRAWING	DESIGN	CHECKED	APPROVED	SCALE	TITLE
Kikuchi	Kikuchi	34.5.24	34.5.24		V147 (PS)
					全体接続図
NAMCO LIMITED					24219101

PRESA POS. 9vie
MINI MATE N LOCK maschio
contatti femmina

1	VI-BI	1P Shoot
2	BL	2P Shoot
3	BL-NE	GOUT 0
4	GI-NE	GOUT 1
5	CL	GOUT 2
6	MA-BI	GOUT 3
7	VE-CL	GOUT 4
8	BI	SYNC
9	NE	GND

PRESA POS. 6vie
MINI MATE N LOCK maschio
contatti femmina

1	GI	+24 V
2	VE	GND 24 V
3	RO	+5 V
4	MA-NE	+12 V
5	NE	GND
6		

PRESA ALIMENTATORE

+12 V	MA-NE	x2 x3
-5	-	
MTR	RO-MA	
GND	NE	1,5mm x2 + NE x2
+5 V	RO	1,5mm x2 + RO x2
FG	GI-VE	1mm
AC	RO	\ x3
AC	NE	/ piattina 0,5mm

PRESA GETTONIERA
conn. BURNDY 24 vie fisso
contatti femmina

1	MA-NE	+12 V
2	GI-RO	Counter 1
3	NE	GND
4	RO-BI	Test
5	MA-GI	Service
6	NE	GND
7	AR-VE	Coin 1
8	RO	+5 V Lamp
9	NE	GND Lamp
10	VE-GR	Speaker R+
11	VI	x2 Speaker R-
12	GI	Speaker R Ret.
13	MA-VE	Speaker L+
14	MA-ROSA	x2 Speaker L-
15	VE	Speaker L Ret.
16	GI-VE	1mm GROUND
17		
18		

PRESA POS. 15 vie
MINI MATE N LOCK maschio
contatti femmina

1	GI	+24 V
2	GI	+24 V
3	MA-NE	+12 V
4	RO	+5 V
5	RO	+5 V
6	RO-BL	SOL 1
7	GI-RO	TRG 1
8	NE	GND
9	AR	SENSOR 1
10	VE	LMP 1
11	RO-VE	SOL 2
12	BI-BL	TRG 2
13	NE	GND
14	VE-ROSA	SENSOR 2
15	VE-NE	LMP 2

PRESA INSEGNA
conn. AMP UML 3 vie fisso
contatti femmina

1	RO
2	GI-VE 1mm
3	NE

preisolato forchetta rosso 7mm

preisolato forchetta rosso 7mm
preisolato forchetta giallo 7mm
preisolato forchetta giallo 7mm
preisolato forchetta rosso 7mm
preisolato forchetta rosso 7mm
preisolato forchetta rosso 7mm

PRESA CONSOLLE
conn. BURNDY 24 vie fisso
contatti femmina

1	GI	+24 V
2	GI	+24 V
3	MA-NE	+12 V
4	RO	+5 V
5	RO	+5 V
6	RO-BL	SOL 1
7	GI-RO	TRG 1
8	NE	GND
9	AR	SENSOR 1
10	VE	LMP 1.
11	RO-VE	SOL 2.
12	BI-VI	TRG 2
13	NE	GND
14	VE-ROSA	SENSOR 2
15	VE-NE	LMP 2
16	RO-NE	1P Start
17	BI-GR	2P Start
18	NE	GND
19	GI-VE 1mm	GROUND

PRESA 28 VIE DOPPIE JAMMA

		Lato saldature		Lato componenti		
GND			NE	A—1	NE 1,5 mm	GND
GND				B—2	NE 1,5 mm	GND
+5 V			RO-MA	C—3	RO 1,5 mm	+5 V
+5 V				D—4	RO 1,5 mm	+5 V
-5 V				E—5		-5 V
+12 V				F—6	MA-NE	+12 V
				H 7		
				J 8	GI-RO	Counter 1
				K 9		
Speaker L-		MA-ROSA		L 10	MA-VE	Speaker L+
				M 11		
Video GREEN	cavo	/	VE	N 12	RO \	Video RED
Video SYNC	Hantarex	\	BI x2	P 13	BL >	Video BLUE
Service			MA-GI	R 14	NE /	Video GND
				S 15	RO-BI	Test
				T 16	AR-VE	Coin 1
2P Start		BI-GR		U 17	RO-NE	1P Start
				V 18		
				W 19		
				X 20		
				Y 21		
2P Shoot			BL	Z 22	VI-BI	1P Shoot
				a 23		
				b 24		
				c 25		
				d 26		
GND			NE	e 27	NE	GND
GND			NE	f 28	GI-VE 1mm	GND

PRESA 24 VIE DOPPIE p 2,54

		A	B	
Speaker R-	VI	1	VE-GR	Speaker R+
		2		
		3		
		4		
		5		
GOUT 0	BL-NE	6	GI-NE	GOUT 1
GOUT 2	CL	7	MA-BI	GOUT 3
GOUT 4	VE-CL	8		
		9		
		10		
		11		
		12		
		13		
		14		
		15		
		16		
		17		
		18		
		19		
		20		
		21		
		22		
		23		
		24		

Conn. BURNDY 24 Vie volante
contatti maschi

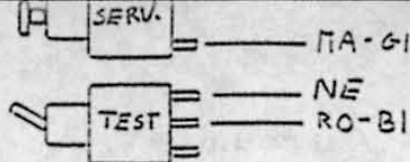

- 1 MA-NE +12 V
- 2 GI-RO Counter 1
- 3 NE x2 GND
- 4 RO-BI Test
- 5 MA-GI Service
- 6 NE GND
- 7 AR-VE Coin 1
- 8 RO +5 V Lamp
- 9 NE GND Lamp
- 10 VE-GR Speaker R+
- 11 VI Speaker R-
- 12 GI Speaker R Ret.
- 13 MA-VE Speaker L+
- 14 MA-ROSA Speaker L-
- 15 VE Speaker L Ret.
- 16 GI-VE 1mm GROUND
- 17
- 18

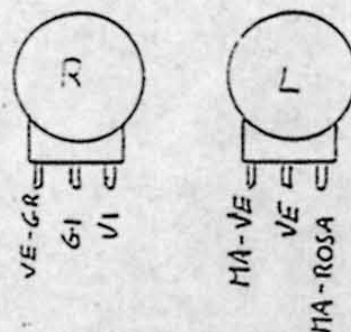

PETTINE GETTONIERA

+12 V	MA-NE	da	Presca gettoniera	a	Comandi
Counter 1	GI-RO	da	" "	a	"
GND	NE x2	da	" "	a	"
Test	RO-BI	da	" "	a	"
Service	MA-GI	da	" "	a	"
Speaker R+	VE-GR	da	" "	a	"
Speaker R-	VI	da	" "	a	"
Speaker R Ret.	GI	da	" "	a	"
Speaker L+	MA-VE	da	" "	a	"
Speaker L-	MA-ROSA	da	" "	a	"
Speaker L Ret.	VE	da	" "	a	"
GND	NE	da	" "	a	Micro gettoniera
Coin 1	AR-VE	da	" "	a	"
+5 V Lamp	RO	da	" "	a	"
GND Lamp	NE	da	" "	a	"
GROUND	GI-VE 1mm	da	" "	a	"

I fili NE /AR-VE /RO /NE all'uscita Micro gettoniera vanno intestati con preisolati faston femmina 4,7mm rosso.
Il filo GI-VE 1mm all'uscita Micro gettoniera va intestato con preisolato ad occhio rosso ϕ 5.

PRESA CONSOLLE
 conn. BURNDY 24 vie volante
 contatti maschi

1	GI	+24 V
2	GI	+24 V
3	MA-NE	+12 V
4	RO	+5 V
5	RO	+5 V
6	RO-BL	SOL 1
7	GI-RO	TRG 1
8	NE	GND
9	AR	SENSOR 1
10	VE	LMP 1
11	RO-VE	SOL 2
12	BI-VI	TRG 2
13	NE	GND
14	VE-ROSA	SENSOR 2
15	VE-NE	LMP 2
16	RO-NE	1P Start
17	BI-GR	2P Start
18	NE	GND
19	GI-VE 1mm	GROUND

PRESA P1 (pistola 1P1)
 MINI MATE N LOCK 6 vie maschio
 cont. femmina
 in alternativa BURNDY 6 vie fisso
 cont.femmina

1	GI	+24 V
2	RO	+5 V
3	AR	SENSOR 1
4	RO-BL	SOL 1
5	GI-RO	TRG 1
6	NE	GND

PRESA P2 (pistola 2P1)
 MINI MATE N LOCK 6 vie maschio
 cont. femmina 15
 in alternativa BURNDY 6 vie fisso
 cont. femmina

1	GI	+24 V
2	RO	+5 V
3	VE-ROSA	SENSOR 2
4	RO-VE	SOL 2
5	BI-VI	TRG 2
6	NE	GND

PETTINE CONSOLLE

+24 V	GI	da	Presa consolle	a	Presa P1
+5 V	RO	da	" "	a	" "
SENSOR 1	AR	da	" "	a	" "
SOL 1	RO-BL	da	" "	a	" "
TRG 1	GI-RO	da	" "	a	" "
GND	NE	da	" "	a	" "
+24 V	GI	da	" "	a	Presa P2
+5 V	RO	da	" "	a	" "
SENSOR 2	VE-ROSA	da	" "	a	" "
SOL 2	RO-VE	da	" "	a	" "
TRG 2	BI-VI	da	" "	a	" "
GND	NE	da	" "	a	" "
+12 V	MA-NE x2	da	" "	a	Start
LMP 1	VE	da	" "	a	" "
LMP 2	VE-NE	da	" "	a	" "
1P Start	RO-NE	da	" "	a	" "
2P Start	BI-GR	da	" "	a	" "
GND	NE x2	da	" "	a	" "
GROUND	GI-VE 1mm	da	" "	a	Massa

Il filo GI-VE va intestato con preisolato ad occhiello rosso ϕ 5.
 I fili all'uscita Start vanno intestati ognuno con preisolati faston
 femmina 4,7mm rosso.

5-4 Test mode

The test mode allows testing of switches, changing of game fees, setting of games and other adjustments.

- (1) Open the coin door and turn the test switch "ON". The game machine enters the test mode.
- (2) The mode changes over in the order given below each time the service switch is pressed.

① SWITCH TEST _____ Tests various switches. (See 5-4-1)



② GOUT TEST _____ Tests the control systems. (See 5-4-2)



③ GAME MENU _____ Sets games. (See 5-4-3)



④ COIN OPTIONS _____ Sets game fees. (See 5-4-4)



⑤ COLOR TEST _____ Tests the monitor.



⑥ CONVERGENCE TEST _____ Tests the monitor.



⑦ SOUND TEST _____ Tests the sound. (See 5-4-5)



Returns to the "SWITCH TEST".

- (3) To return to the game screen, turn the test switch "OFF". Normally, place the test switch in the "OFF" position.

5-4-1 Switch test

Select the "SWITCH TEST" shown in 1. The following screen is displayed:

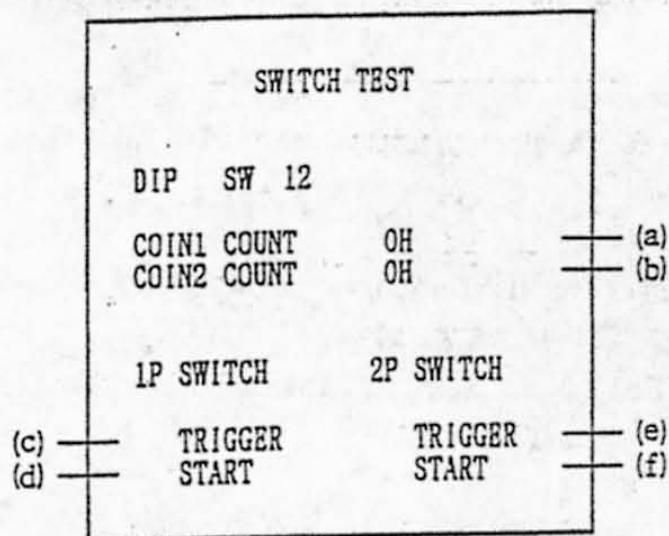

Fig. 7 Switch Test Screen

- (a) Turn the coin 1 switch "ON". The number increase.
- (b) Not used.
- (c) Pull the trigger of the player-1 gun. The characters are displayed in red.
- (d) Press the start button on the player-1 side. The characters are displayed in red.
- (e) Pull the trigger of the player-2 gun. The characters are displayed in red.
- (f) Press the start button on the player-2 side. The characters are displayed in red.

Pressing the service switch switches the current screen to the next test screen. To return to the game screen, turn the test switch "OFF".

5-4-2 Control system test

Select the "GOUT TEST" shown in 2. The following screen is displayed:

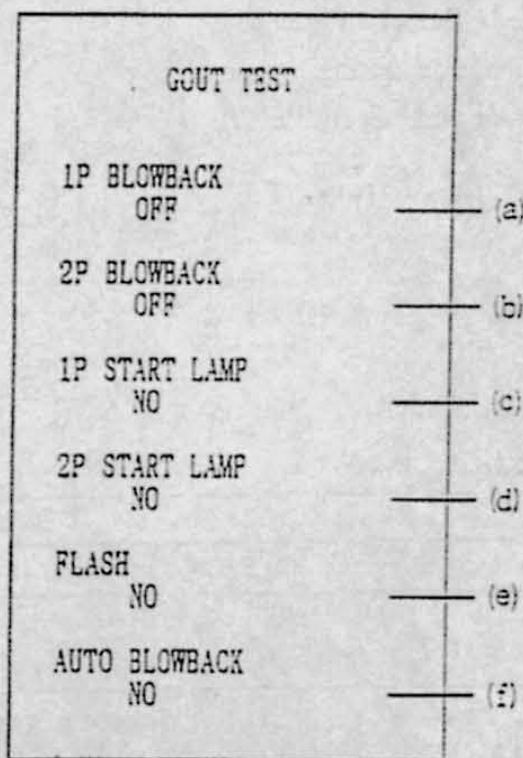

Fig. 8 GOUT TEST Screen

The "GOUT TEST" tests the blowback operations of the gun and lamps. The item moves down one by one each time the start button on the player-1 side is pressed or the trigger of the gun is pulled. Select an item to be tested and press the start button on the player-2 side or pull the trigger of the gun.

The operation works as follows:

- (a) The blowback operation of the player-1 gun works once.
- (b) The blowback operation of the player-2 gun works once.
- (c) "YES" is displayed and the start button on the player-1 side continues to blink.
- (d) "YES" is displayed and the start button on the player-2 side continues to blink.
- (e) "YES" is displayed and the signboard lamp continues to blink.
- (f) "YES" is displayed, and the blowback operations of both player-1 and player-2 guns continue to work.

Pressing the service switch switches the current screen to the next test screen. To return to the game screen, turn the test switch "OFF".

5-4-3 Setting of game menu

Select the "GAME MENU" shown in ③ to set a game menu.

The item moves down one by one each time the start button on the player-1 side is pressed or the trigger of the gun is pulled. Select an item to be tested and press the start button on the player-2 side or pull the trigger of the gun. (See table 1)

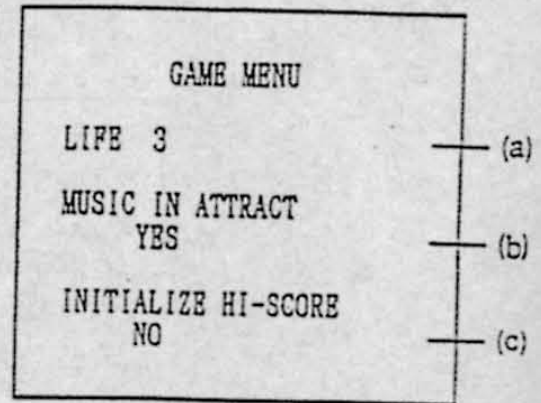

Fig. 9 Game Menu Screen

Table 1 Game Menu Setting Table

(◁: Original setting:)

Item	Description
(a) No. of lives at start of game	1 to 5 (Original setting: 3)
(b) Attract sound	YES ◁ NO
(c) High-score initialization in each stage	YES (This operation has a little wait time when leaving NO ◁ the test mode)

Pressing the service switch switches the current screen to the next test screen. To return to the game screen, turn the test switch "OFF".

5-4-4 Setting of game fees

Select the "COIN OPTIONS" shown in 4 to set game fees.

The item moves down one by one each time the start button on the player-1 side is pressed or the trigger of the gun is pulled. Select an item to be tested and press the start button on the player-2 side or pull the trigger of the gun (See Table 2).

Pressing the service switch switches the current screen to the next test screen. To return to the game screen, turn the test switch "OFF".

COIN OPTIONS	
GAME COST 1 COIN 1 CREDIT	(a)
DISCOUNT TO CONTINUE NO	(b)
COIN1 MECH VALUE 1 COIN COUNT AS 1 COIN	(c)
COIN2 MECH VALUE 1 COIN COUNT AS 1 COIN	(d)
BONUS FOR QUANTITY BUY IN NONE	(e)
FREE PLAY NO	(f)
COIN BOX 1WAY	(g)

Fig. 10 Coin Options Screen

Table 2 Coin Options Setting Table

(◁: Original setting:)

Item	Description	
(a) Setting of game fee	No. of coins required for one game (one credit)	1COIN to 9 COINS
(b) Continue game fee	Setting of half of game fee for continuation	NO (Same game fee) ◁ YES (Half of game fee)
(c) Coin counter 1	A count per coin	1COIN ◁ to 9 COINS
(d) Coin counter 2	A count per coin	1COIN ◁ to 9 COINS
(e) Bonus coin	Bonus credit is added when the specified number of coins is entered.	NONE ◁ 2 COIN GIVES 1 COIN to to 9 COINS 3 COINS
(f) Free play	Free play allowing a game to start when the start button is pressed.	NO ◁ YES
(g) Coin box		1 WAY ◁ 2 WAY

5-4-5 Sound test

Test the various sounds.

Select the "SOUND TEST" shown in 7 to display the following screen and test sounds.

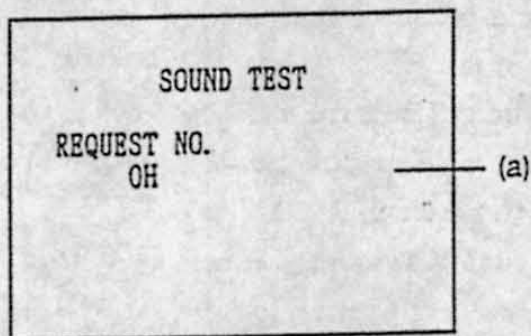

Fig. 11 Sound Test Screen

- (a) To go back to the previous sound number, press the player-1 start button.
- To go to the next sound number, press the player-2 start button.
- Pull the trigger of player-1 or player-2 gun. The music will start.

Pressing the service switch switches the current screen to the next test screen. To return to the game screen, turn the test switch "OFF".

5-4-6 Gun initialization

Make the following operations for adjustment whenever replacing the game PC board, ROM and gun Assy; otherwise, the game machine will not work properly. Be careful in adjustment work.

This paragraph describes the initialization of player-1 gun.

- (1) Turn the test switch "ON" with the service switch pressed. The "1P GUN INITIALIZE" initial screen will be displayed.

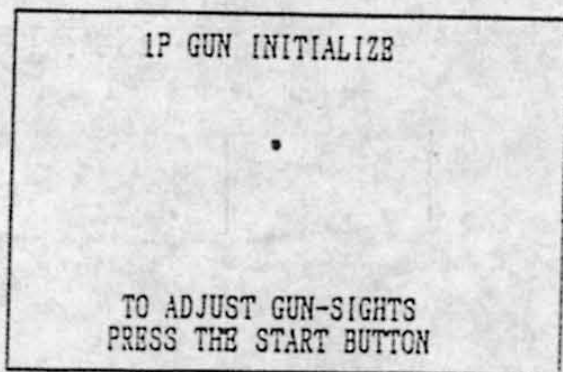

Fig. 12 Gun Initialization Initial Screen

- (2) Press the start button. The adjustment screen shown in Fig. 13 will be displayed.

Note: Do not press the service switch or do not turn the test switch "OFF" without performing adjustment on this screen; otherwise, the gun will be out of position and the game machine will not work properly.

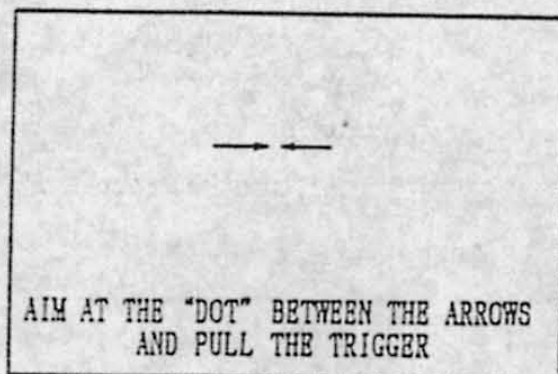

Fig. 13 Gun Initialization Adjustment Screen

- (3) When the adjustment screen shown in Fig. 13 is displayed, stand up in front of the game machine and aim in between the arrows (→ ←) in the middle of screen. (See fig. 14)

At this time, keep the gun level. If inclined, the gun cannot be initialized accurately. (See fig. 15)

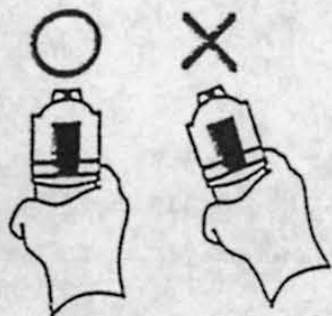

Fig. 15

14

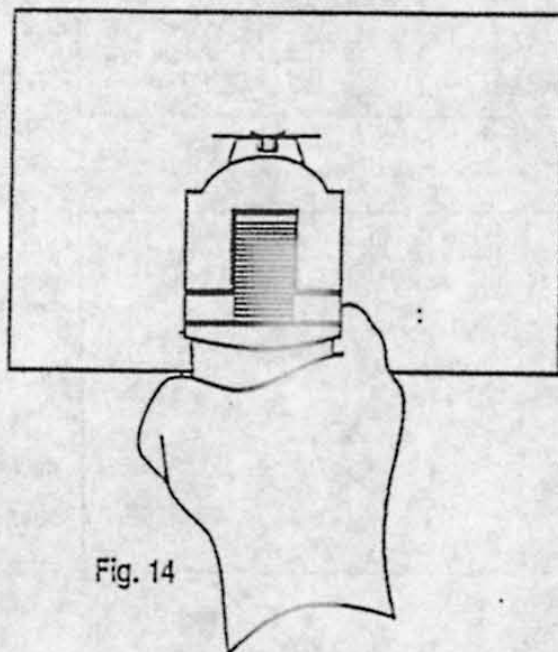

Fig. 14

- (4) When you are aiming the gun almost one second in the state of (3), the screen cursor comes between the arrows (—•—) as shown in Fig. 16.

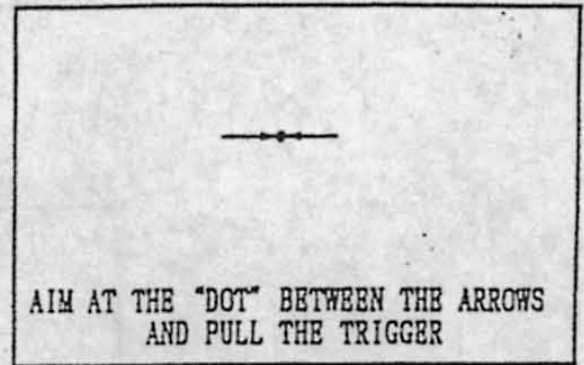

Fig. 16

- (5) When the gun sight aims directly at the cursor, pull the trigger. The check screen shown in Fig. 17 is displayed.

The check screen allows you to check the gun for accurate adjustment while operating.

Face the gun in various directions on the screen to check that the cursor is in the gun sight. (See Fig. 18)

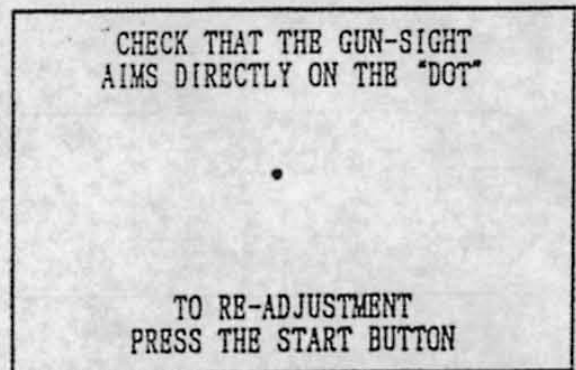

Fig. 17 Check screen

Confirm if the cursor is in the gun sight.

- (6) Check the result of adjustment. If the cursor is out of the gun sight, press the start button once again. The current screen will return to the adjustment screen (Fig. 13) for readjustment.
- (7) If the cursor comes in the gun sight to aim the gun at a target, the adjustment will be completed. Press the service switch. The gun initialization screen for player-2 is displayed. Initialize the player-2 gun in the same manner.

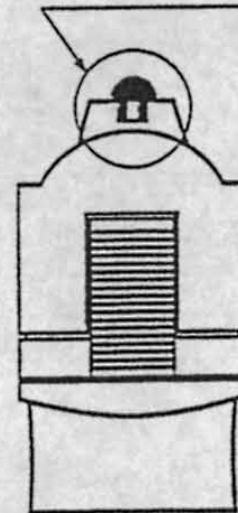

Fig. 18

Note: If the service switch is pressed or the test switch is turned "OFF" without making any adjustment on the adjustment screen (Fig. 13), the cursor will be out of the gun sight. Be sure to leave the test mode on the check screen (Fig. 17) after adjusting and checking the gun. To return to the game screen, turn the test switch "OFF" on the check screen (Fig. 17). After adjustment, play a game to check for normal adjustment.