

NOTES: \perp IS COMMON CENTER TAP
 |||| IS SPECIAL GROUND AND CAN BE CONNECTED TO COMMON CIRCUITS
 POWER SUPPLY TO BE USED WITH MOTHER BOARD P.C.A082-90002-X000

"SEA WOLF II"
 MIDWAY MFG. CO.
 10750 W. GRAND AVE.
 FRANKLIN PARK, IL. 60131
 6-1-78

MOTHER BOARD A084-90002-B625

CHARACTERIZATION
 P.C.A084-91312-A625

GAME LOGIC P.C.A084-90700-D625

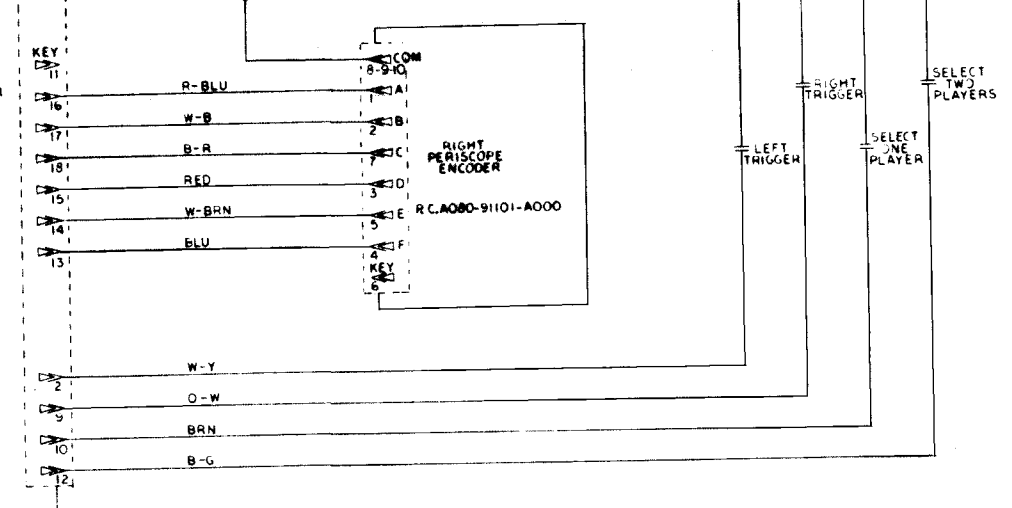
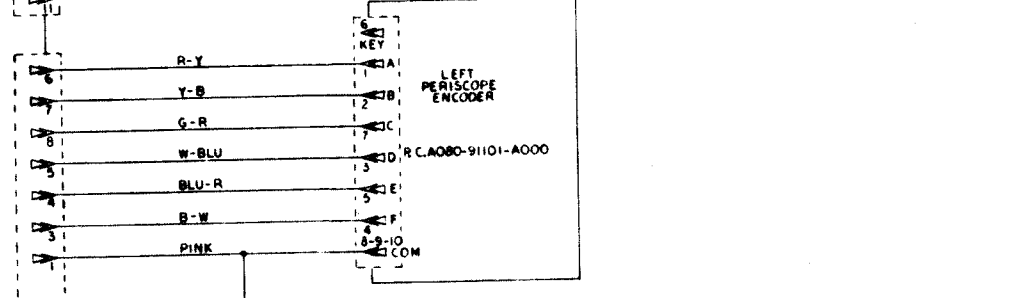
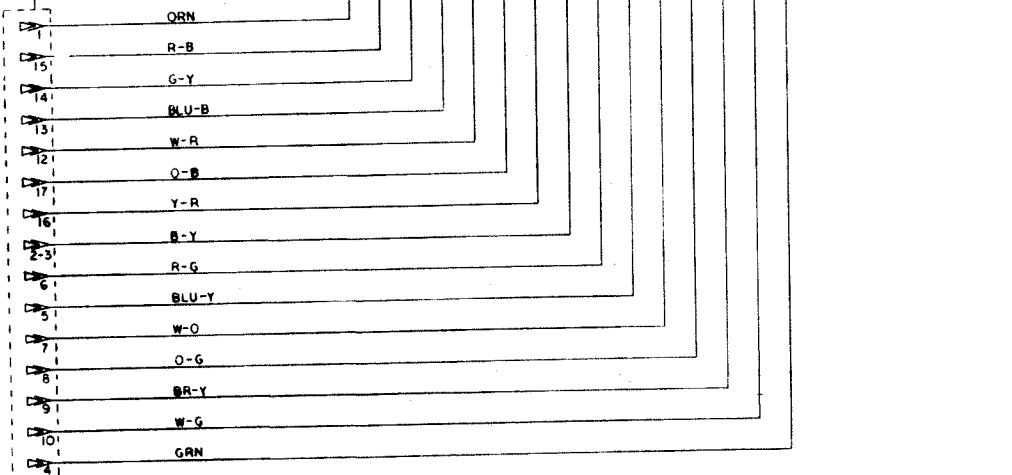
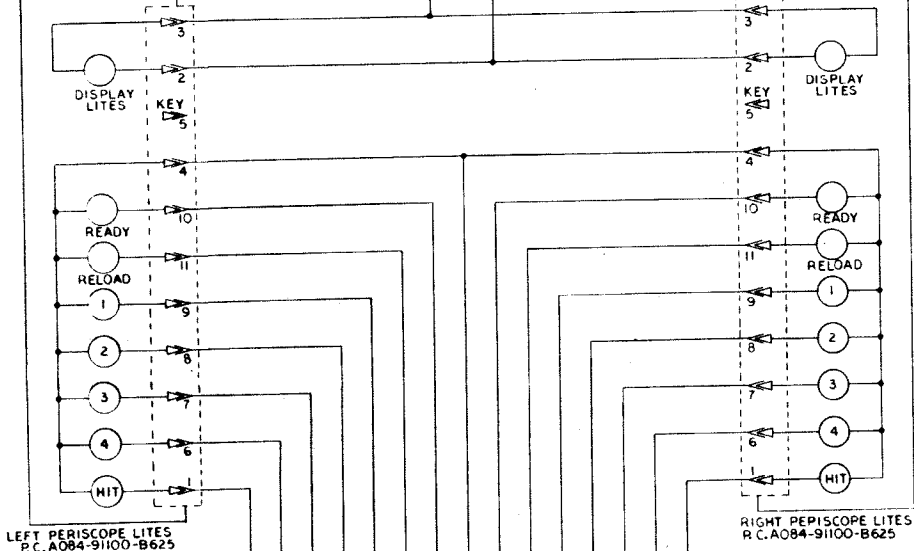
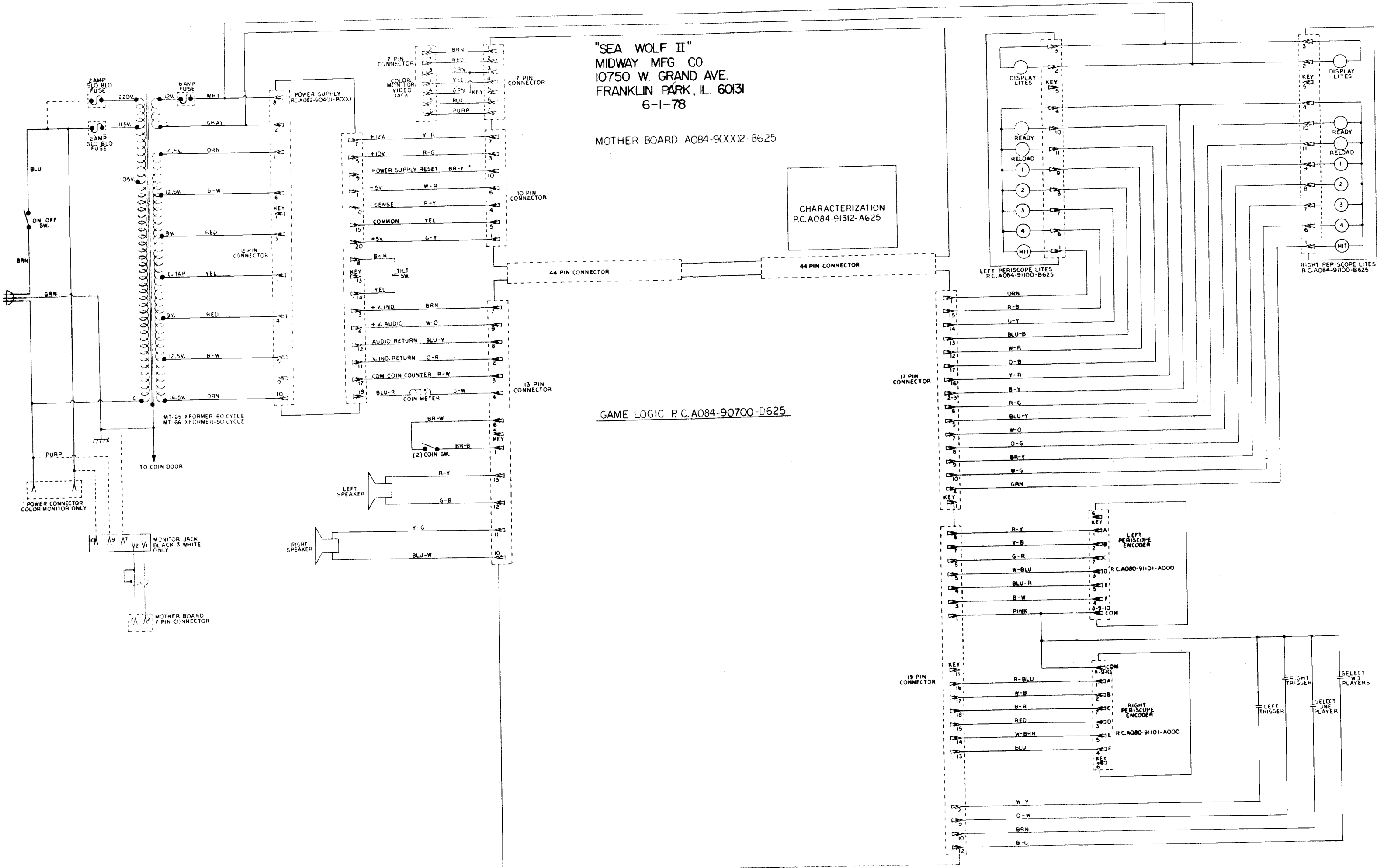

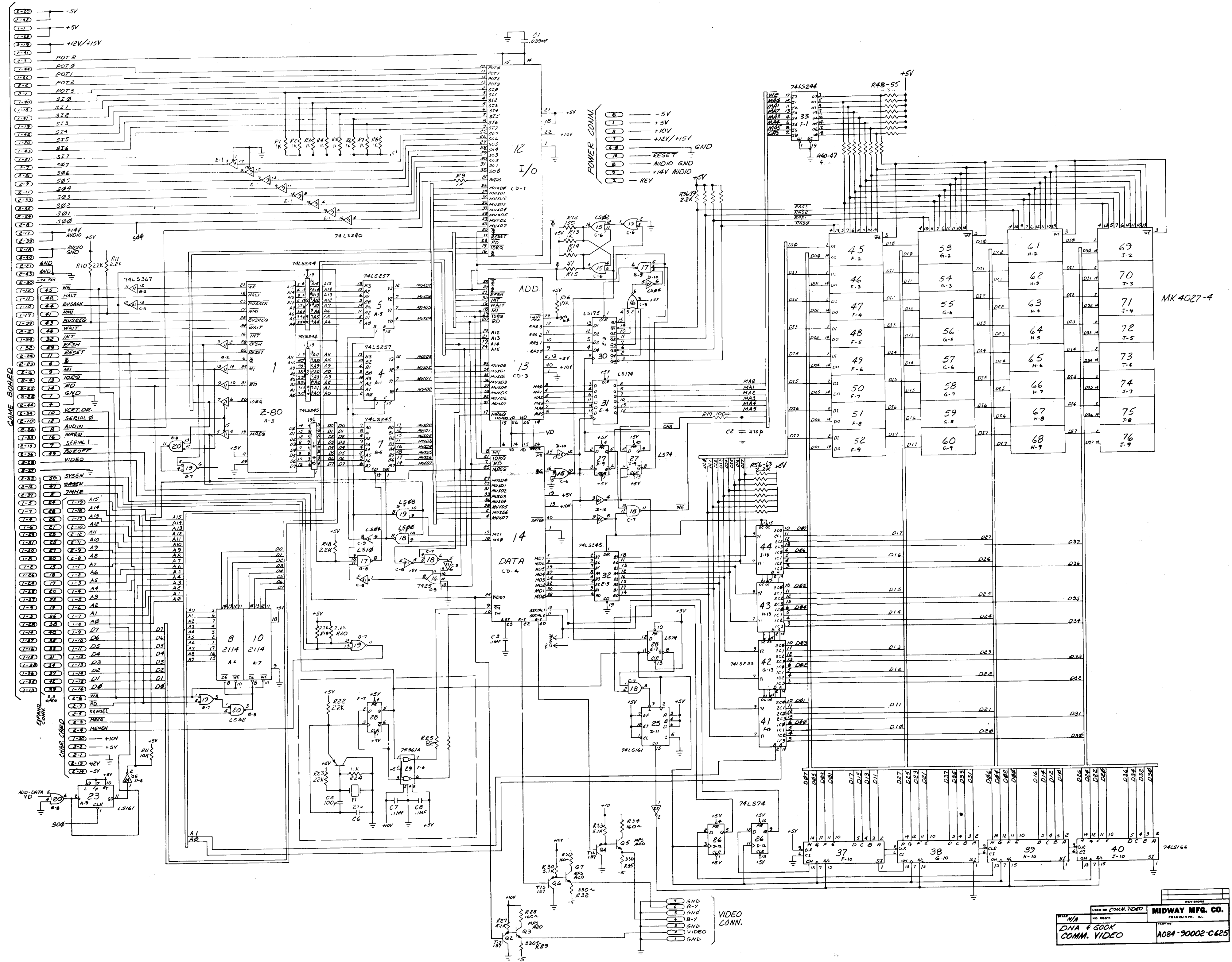

MK 4027-4

REVISIONS		MIDWAY MFG. CO.	
NO.	DESCRIPTION	DATE	BY
1	ISSUED FOR COMM. VIDEO		
2	NO REVISION		
DINA E GOOD		FRANKLIN PR. ILL.	
COMM. VIDEO		PART NO.	
		A084-90002-C625	

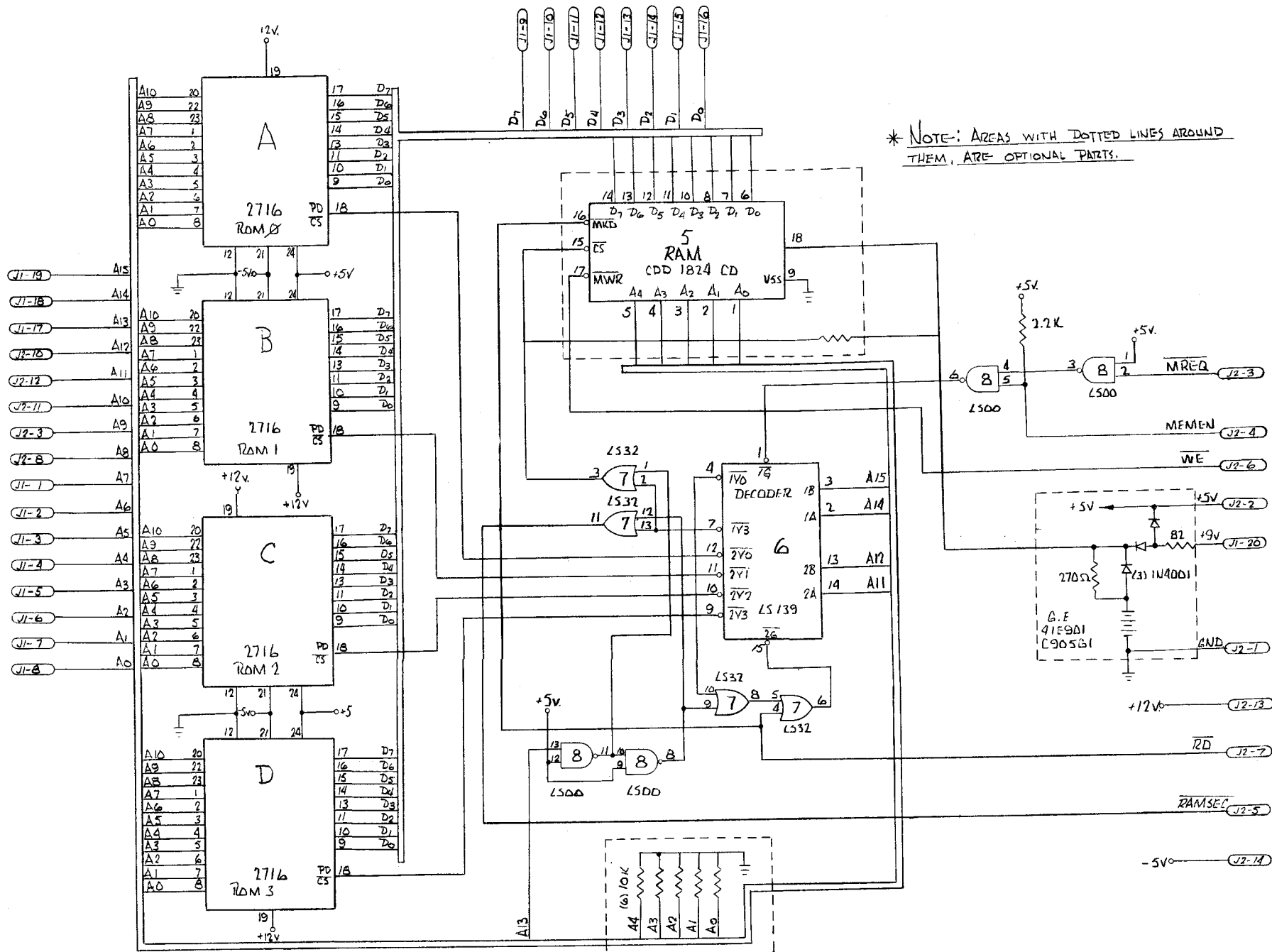

P.C. A084-91312- A625
 GAME CHARACTERIZATION

5-1-78

MIDWAY MFG. CO.
 10750 W. GRAND AVE.
 FRANKLIN PARK, IL. 60131
 "SEA WOLF II"
 GAME LOGIC SCHEMATIC
 P. C. A084-90700-D625
 6-1-78

