

This document has been downloaded from:



The largest resource for amusement machines
documentation on the world wide web!



FLIPPERSPILL.COM

Operators Manual

With Illustrated Parts Lists

TM-276
1st Printing



WARBLE WADNESS



Table of Contents

1 Installation

How to Use This Manual	1-1
Introduction	1-3
Kit Parts Inventory	1-3
Tool Required	1-3
Installation Instructions	1-3
Replace the Attraction Film	1-3
Replace the Control Panel	1-4
Replace the Cartridge PCB	1-5
Install the Self-Test Label	1-6
Install the Labels	1-6
Inspect the Game	1-6
Setting the Options	1-6
Operator Hints	1-6

2 Self-Test

Screen 1—RAM/ROM Test	2-2
Screen 2—Switch Test	2-2
Screen 3—Coin Options	2-3
Screen 4—Game Options	2-4
Screen 5—Statistics	2-4
Screen 6—Histograms	2-5
Screen 7—Playfield Test	2-5
Screen 8—Motion Object Test	2-5
Screen 9—Motion Object Obscuring Test	2-5
Screen 10—Motion Object Height Test	2-6
Screen 11—Alpha Test	2-6
Screen 12—Color Test 1	2-6
Screen 13—Color Purity Test	2-7
Screen 14—Convergence Test	2-7
Screen 15—Sound Test	2-8
Screen 16—Color Palette Test	2-8

3 Maintenance

Removing the Control Panel	3-2
Removing the Midi Trak-Ball	3-3
Disassembling the Midi Trak-Ball	3-4
Inspecting and Lubricating the Midi Trak-Ball and Shafts	3-6
Removing the Player-Start Switches	3-6
Removing the Cartridge PCB	3-7

4 Game Play

Introduction	4-2
Attract Mode	4-2
Play Mode	4-2
Hints for Game Play	4-2
High-Score Mode	4-2
Maximizing Earnings	4-2

5 Illustrated Parts Lists

See List of Illustrations.

List of Illustrations

Figure 1-1	Game Kit Part Locations	1-2
Figure 1-2	Attraction Film Replacement	1-3
Figure 1-3	Control Panel Replacement	1-4
Figure 1-4	Cartridge PCB Replacement	1-5
Figure 2-1	ROM Test Fails	2-2
Figure 2-2	RAM Test Fails	2-2
Figure 2-3	Switch Test	2-3
Figure 2-4	Coin Options	2-3
Figure 2-5	Game Options	2-4
Figure 2-6	Statistics	2-4
Figure 2-7	Histograms	2-5
Figure 2-8	Playfield Test	2-5
Figure 2-9	Motion Object Test	2-5
Figure 2-10	Motion Object Obscuring Test	2-6
Figure 2-11	Motion Object Height Test	2-6
Figure 2-12	Alpha Test	2-6
Figure 2-13	Color Test	2-7
Figure 2-14	Color Purity Test	2-7
Figure 2-15	Convergence Test	2-8
Figure 2-16	Sound Test	2-8
Figure 2-17	Color Palette Test	2-8
Figure 3-1	Control Panel Removal	3-2
Figure 3-2	Removing the Midi Trak-Ball and Start Switches	3-3
Figure 3-3	Midi Trak-Ball Disassembly and Lubrication	3-5
Figure 3-4	Roller and Idler Shaft Wear	3-6
Figure 3-5	Removing the Cartridge PCB	3-7
Figure 5-1	Control Panel Assembly	5-2
Figure 5-2	Midi Trak-Ball Assembly	5-4
Figure 5-3	Cartridge Printed-Circuit Board Assembly	5-6

List of Tables

Table 1-1	Kit Parts Inventory	1-3
Table 2-1	Faulty ROM Locations	2-2
Table 2-2	Coin Option Settings	2-3
Table 2-3	Game Option Settings	2-4

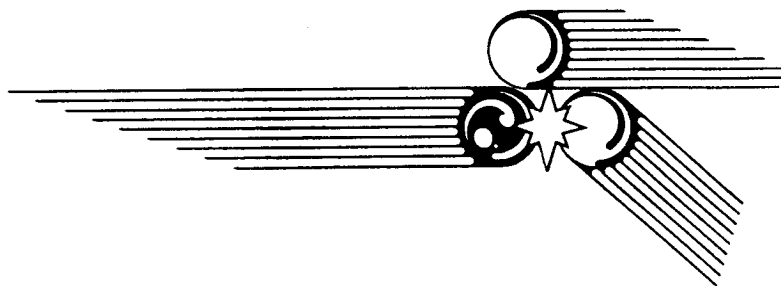

Safety Summary

The following safety precautions apply to all game operators and service personnel. Specific warnings and cautions will be found throughout this manual where they apply.



WARNING



Properly Ground the Game. Players may receive an electrical shock if this game is not properly grounded! To avoid electrical shock, do not plug in the game until it has been inspected and properly grounded. This game should only be plugged into a grounded 3-wire outlet. If you have only a 2-wire outlet, we recommend you hire a licensed electrician to install a grounded outlet. Players may receive an electrical shock if the control panel is not properly grounded! After servicing any parts on the control panel, check that the grounding clip is firmly secured to the metal tab on the inside of the control panel. Only then should you lock up the game.

AC Power Connection. Before connecting the game to the AC power source, verify that the proper voltage-selection plug is installed on the game's power supply.

Disconnect Power During Repairs. To avoid electrical shock, disconnect the game from the AC power source before removing or repairing any part of the game. When removing or repairing the video display, extra precautions must be taken to avoid electrical shock because high voltages may exist within the display circuitry and cathode-ray tube (CRT) even after power has been disconnected. Do not touch internal parts of the display with your hands or with metal objects! Always discharge the high voltage from the CRT before servicing this area of the game. To discharge the CRT: Attach one end of a large, well-insulated, 18-gauge jumper wire to ground. Momentarily touch the free end of the grounded jumper to the CRT anode by sliding it under the anode cap. Wait two minutes and discharge the anode again.

Use Only ATARI Parts. To maintain the safety integrity of your ATARI game, do not use non-ATARI parts when repairing the game. Use of non-ATARI parts or other modifications to the game circuitry may adversely affect the safety of your game, and injure you or your players.

Handle Fluorescent Tube and CRT With Care. If you drop a fluorescent tube or CRT and it breaks, it may implode! Shattered glass can fly six feet or more from the implosion.

Use the Proper Fuses. To avoid electrical shock, use replacement fuses which are specified in the parts list for this game. Replacement fuses must match those replaced in fuse type, voltage rating, and current rating. In addition, the fuse cover must be in place during game operation.

CAUTION

Properly Attach All Connectors. Make sure that the connectors on each printed-circuit board (PCB) are properly plugged in. Note that they are keyed to fit only one way. If they do not slip on easily, do not force them. A reversed connector may damage your game and void the warranty.

Ensure the Proper AC Line Frequency. Video games manufactured for operation on 60 Hz line power (i.e., United States) must not be operated in countries with 50 Hz line power (i.e., Europe). The fluorescent light ballast transformer will overheat, causing a potential fire hazard if 60 Hz games are operated on power lines using 50 Hz. Check the product identification label of your game for the line frequency required.

Installation

How to Use This Manual

This manual is written for game operators and service technicians and describes how to install, test, and maintain your MARBLE MADNESS game.

Your MARBLE MADNESS game uses the Atari Games System I™ cabinet, which is designed to accept the necessary hardware to easily convert the System I cabinet into a variety of games. Consequently, this manual contains information that applies to those parts that are added to your existing System I cabinet to install the MARBLE MADNESS game (see Figure 1-1).

Information that applies to those parts of the System I cabinet that are common to all games is contained in a separate manual—the *System I Operators Manual* (TM-277), which is included with each System I cabinet.

This manual contains the following information on the MARBLE MADNESS game:

- Chapter 1 provides a kit parts inventory, installation instructions, inspection procedures, and option setting information.
- Chapter 2 provides self-test procedures (includes procedures for setting the coin and game options).
- Chapter 3 provides maintenance information for the Midi Trak-Ball™ and the player-start pushbutton switches.
- Chapter 4 provides game play information.
- Chapter 5 provides illustrated parts lists for the MARBLE MADNESS Cartridge printed-circuit board (PCB), control-panel assembly, and Midi Trak-Ball.

Wiring and schematic diagrams for the MARBLE MADNESS control panel and Cartridge PCB are contained in the SP-276 Schematic Package Supplement included with this manual. Refer to the Schematic Package Supplement included with the System I cabinet operators manual for the wiring and schematic diagrams that apply to the System I cabinet hardware.

Chapter 1

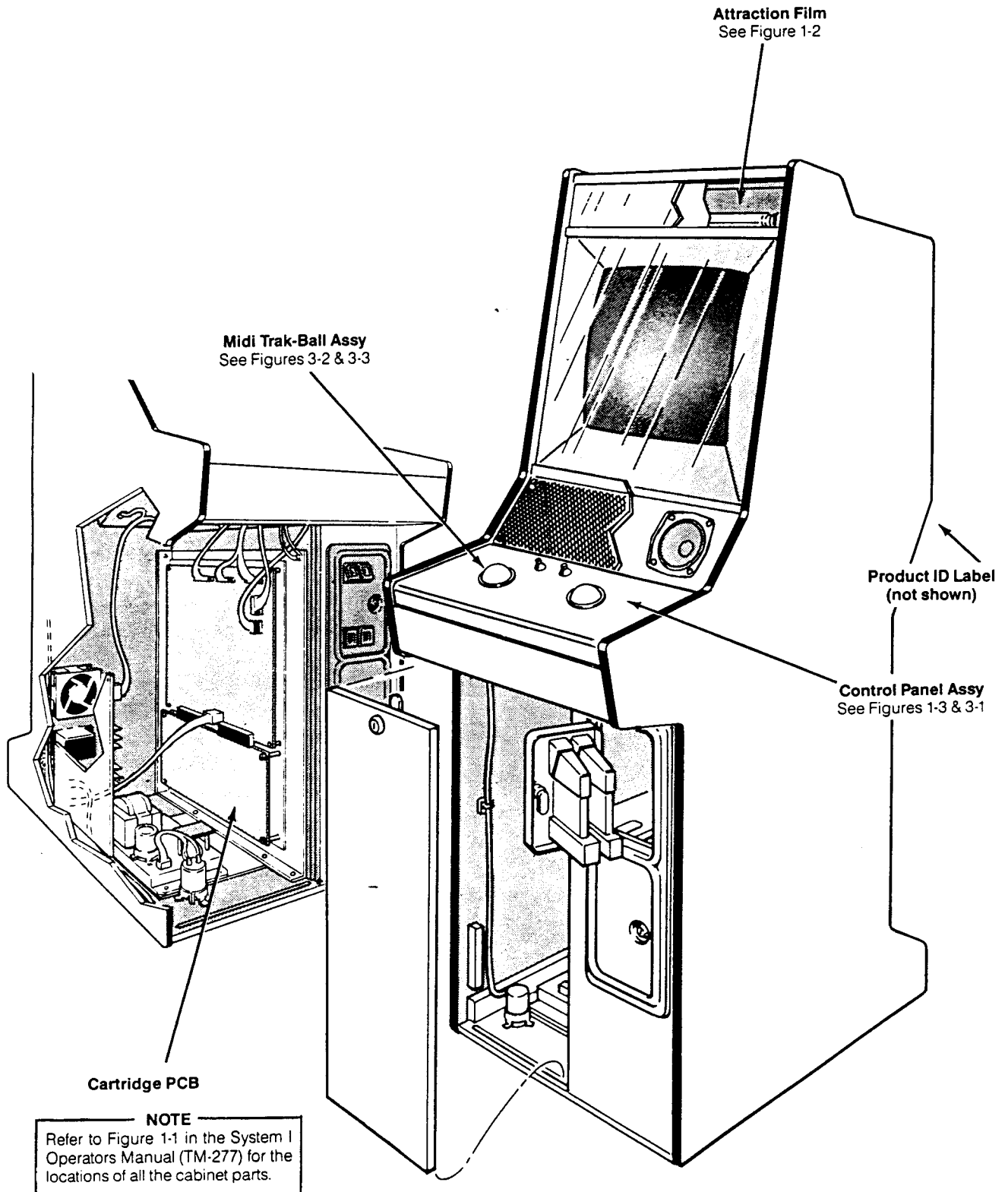

Figure 1-1 Game Kit Part Locations

Introduction

This chapter includes the instructions necessary for installing a MARBLE MADNESS game in your System I cabinet. The installation instructions include: (1) removing the existing attraction film, control panel, and Cartridge printed-circuit board (PCB); and (2) installing a MARBLE MADNESS attraction film, Cartridge PCB, and control panel. Refer to Figure 1-1 for the locations of the parts of the System I cabinet that are replaced.

Kit Parts Inventory

The assemblies listed in Table 1-1 are included in the MARBLE MADNESS Game Kit. Refer to Chapter 5, Illustrated Parts List, for a description of the component parts comprising the control panel and Cartridge PCB assemblies listed in Table 1-1.

**Table 1-1 Kit Parts Inventory
A042929-01**

Part No.	Quantity	Description
A042872-01	1	Control-Panel Assembly
A043056-01	1	Cartridge PCB Assembly
038158-01	1	Product Identification Label (Non-UL)
042893-01	1	Attraction Film
SP-276	1	MARBLE MADNESS Schematic Package Supplement
ST-276	1	Self-Test Label
TM-276	1	MARBLE MADNESS Game Kit Operators Manual

Tools Required

The only tools required to perform a complete MARBLE MADNESS installation are a Phillips screwdriver and a $\frac{1}{8}$ -inch hex driver.

⚠ WARNING ⚠

To avoid electrical shock, unplug the game before performing the installation procedures.

NOTE

The following installation should be performed by qualified service personnel.

The following procedures are arranged in the sequence recommended for performing the game installation. The parts of your cabinet that are affected by the installation are removed first and then replaced by the new MARBLE MADNESS kit parts.

Replace the Attraction Film

Perform the following procedure to remove/replace the existing attraction film with the MARBLE MADNESS attraction film (see Figure 1-2).

1. Turn off the game power.
2. Use a $\frac{1}{8}$ -inch hex driver to remove the three screws and washers securing the upper retainer to the top of the cabinet.
3. Grasp the top edge of the existing attraction film behind the attraction shield and slide it up to remove.
4. Install the MARBLE MADNESS attraction film. Make sure the film is fully inserted into the bottom slot.
5. Replace the upper retainer.

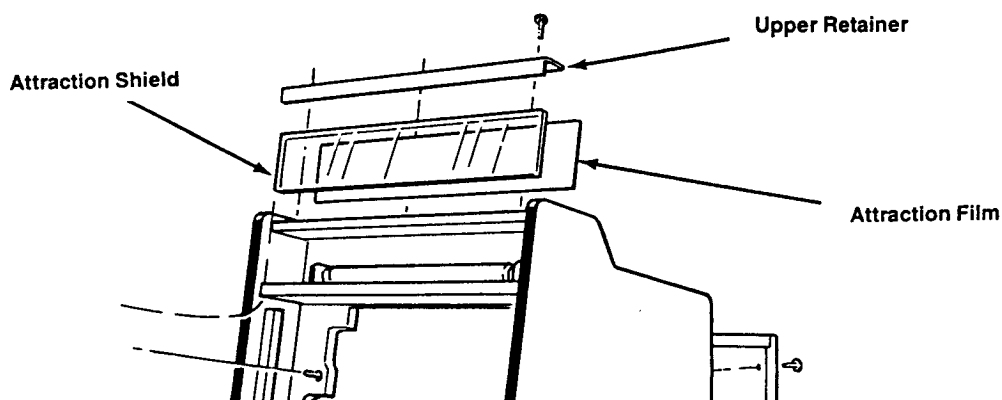

Figure 1-2 Attraction Film Replacement

Replace the Control Panel

Perform the following procedure to remove/replace the existing control panel with the MARBLE MADNESS control panel (see Figure 1-3).

1. Unlock and open the coin door on the front of the cabinet.
2. Carefully reach through the coin door opening and release the spring-draw latch located under the control panel on the right side of the cabinet.
3. Unlock and remove the front-access panel.
4. Reach through the front access-panel opening and disconnect the control-panel harness from the top of the Main PCB.
5. Carefully reach up under the top of the front-access panel opening and release the spring-draw latch located under the control panel on the left side of the cabinet.
6. From underneath, push up on the front edge of the control panel to free the panel from the slot in the cabinet.
7. Disconnect the green ground wire from the control-panel harness and remove the control panel from the cabinet.
8. Install the MARBLE MADNESS control panel in the reverse order of removal. Refer to Figure 3-2 for the proper control-panel harness connections to the Main PCB. Make sure the green ground wire is connected to the control panel.

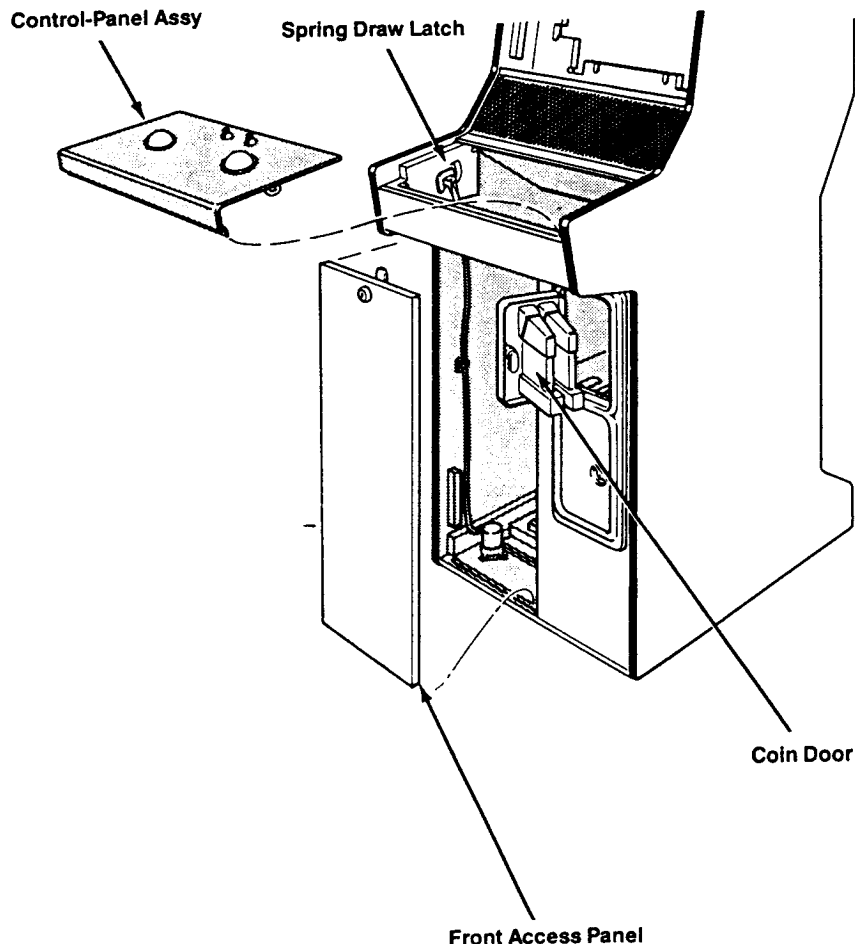

Figure 1-3 Control Panel Replacement

Replace the Cartridge PCB

Perform the following procedure to remove/replace the existing game Cartridge PCB and replace with the MARBLE MADNESS Cartridge PCB (see Figure 1-4).

1. Turn the cabinet power off.
2. Unlock and remove the front-access panel from the cabinet.
3. Disconnect the harness connectors from the Main PCB.
4. Use a Phillips screwdriver to remove the four screws securing the ground plane to the cabinet.
5. Carefully remove the ground plane, with the PCB(s) attached, and place on a clean surface.
6. Use a Phillips screwdriver to remove the four screws securing the existing Cartridge PCB to the ground plane.
7. Gently disconnect the Cartridge PCB from the Main PCB.
8. Connect the MARBLE MADNESS Cartridge PCB to the Main PCB.
9. Secure the the MARBLE MADNESS Cartridge PCB to the ground plane and replace the ground plane, with the PCBs attached, in the cabinet. Make sure that the Cartridge PCB is fully inserted into the Main PCB edge connectors and the ground strap is properly connected to the ground plane. Refer to Figure 1-4 for the ground strap and harness connector locations.

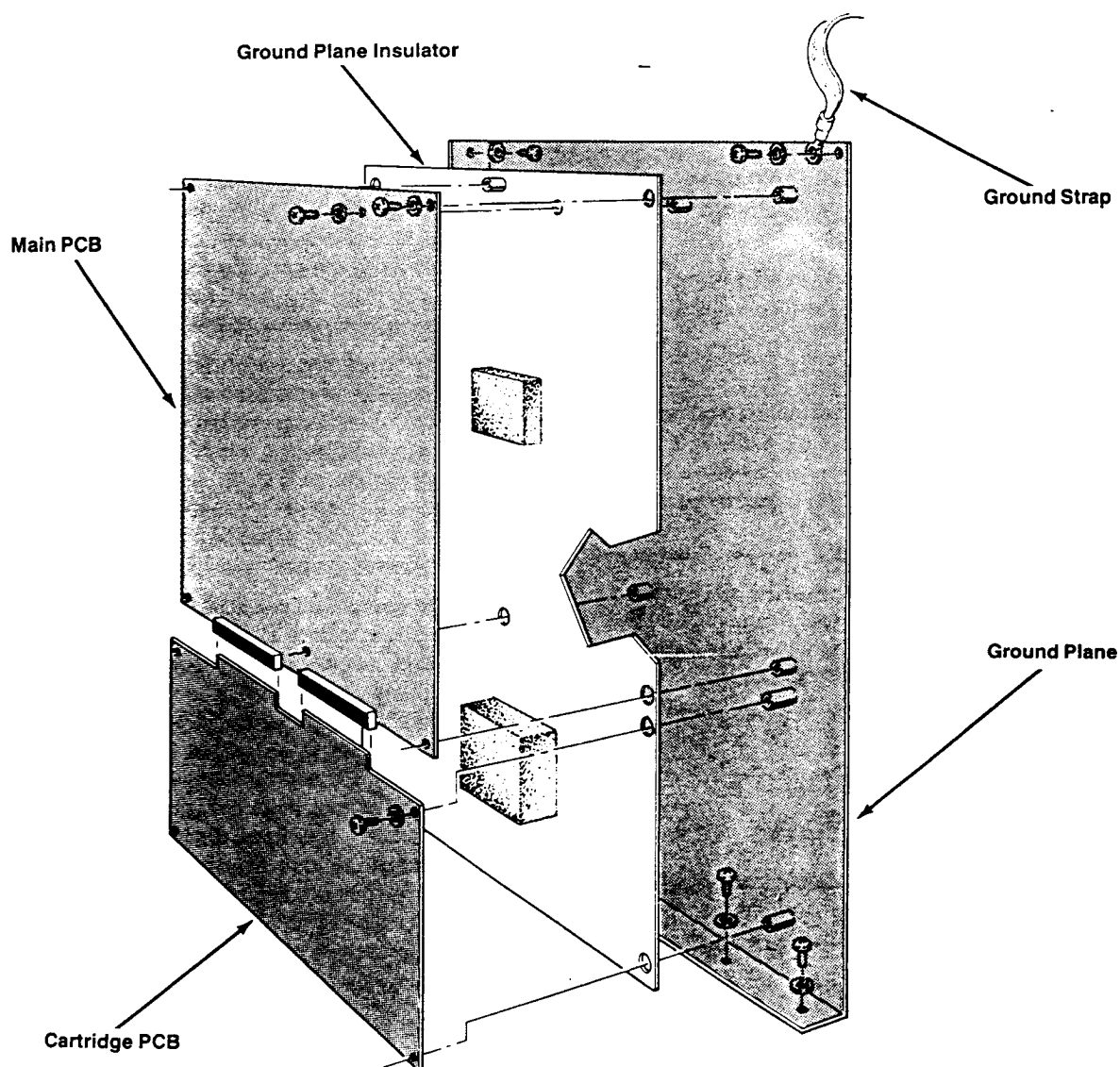

Figure 1-4 Cartridge PCB Replacement

Install the Self-Test Label

Staple or tape the MARBLE MADNESS self-test label on the inside of the front-access panel.

Install the Labels

Perform the following procedure to install the MARBLE MADNESS product identification label.

1. Remove the protective backing from the MARBLE MADNESS product identification label.
2. Place the MARBLE MADNESS product identification label over the existing product identification label on the back of the cabinet.

Inspect the Game

Before applying power, perform the following inspection procedure.

1. Carefully check that the MARBLE MADNESS game kit parts have been properly installed. Make sure the control-panel harness connector is tightly connected and that the spring-draw latches under the control panel are securely fastened.
2. When you are confident that all instructions were properly followed, close and lock the front-access panel.
3. Plug in the game power.
4. Perform the self-test procedure as given in Chapter 2 of this manual. If the self-test indicates that the display requires adjustment, perform the adjustment procedures described in the display manual.

NOTE

In the Game Mode, the MARBLE MADNESS game display does not use the full width of the screen. Approximately 1 inch of blank area on each side of the screen is normal.

Setting the Coin and Game Options

The MARBLE MADNESS coin and game options are set in the Self-Test Mode. Refer to the Options display described in Chapter 2 for the recommended settings and the procedure for setting the options.

Operator Hints

Your System I cabinet with the MARBLE MADNESS game uses more effective audio than previous games, which results in more player involvement and enjoyment. The System I games use advanced, digital, sound-generation techniques to create realistic musical instrument sounds (such as clarinets, harmonicas, drums, and violins). Although a player may not be consciously aware of the music, it has a direct effect on the excitement and emotional experience of the game.

The MARBLE MADNESS game creates ear-catching sound effects, which are designed to give feedback to make the player believe that the game is responding directly to his actions. To maximize the player's enjoyment of this enhanced audio, we are providing some hints for the operator:

1. The game location should be a relatively dead acoustical environment. The goal is to minimize unnecessary sound reflection, so that the sounds from the MARBLE MADNESS game won't be drowned out by the accumulation of other sounds that bounce around the room. Carpets help eliminate sound reflections from the floor. Acoustical tile is also useful, especially if you have low ceilings.
2. If you use an environmental sound system or a stereo, consider lowering its volume or perhaps even turning it off. In the days when video games just made harsh beeps and boops, a central sound system helped make up for the lack of drive and excitement in a game's sounds. But your MARBLE MADNESS game is very musical, and a sound system interferes with the game's ability to interest players and draw bystanders.
3. Be concerned with the overall volume levels in arcade environments. The goal is to involve the players' emotions, not to damage their hearing. To a certain point, raising the game volume helps add to player excitement, but above that level it creates hearing fatigue and the high volume starts to drive players away. Rather than turning up the volume on the MARBLE MADNESS games to cut through the background sound level, try lowering the volume of any neighboring games that have sounds which are not an attractive or important element. Careful placement of games and attention to unnecessary noise sources can also help increase the player's sense of game involvement and interaction.

Self-Test

This game will test itself and provide visual and audible indications of the condition of the game circuitry and controls. Self-test information is visually displayed on the screen and audibly presented through the sound system. No additional equipment is required.

We suggest that you perform a self-test when you first set up the game, each time you collect the money, or when you suspect game failure. Coin and game options are selected in the Self-Test Mode.

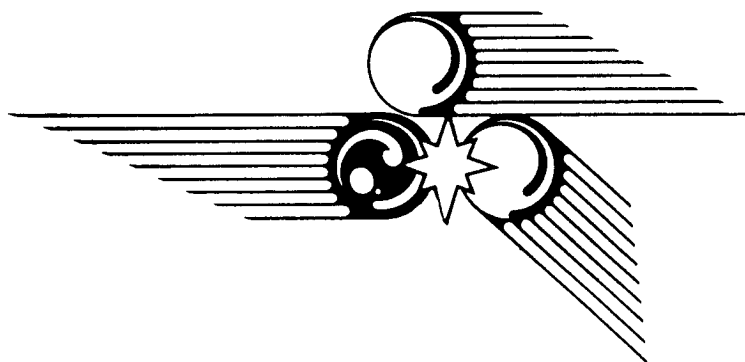

Sixteen self-test screens provide a visual and audible check of the MARBLE MADNESS game circuits. Refer to Chapter 1 in the System I operators manual for the self-test switch location.

When the self-test switch is turned on, the game enters the Self-Test Mode. The following self-test screens are arranged in the sequence in which they occur after the self-test switch is first turned on. After Screen 16—Color Palette Test, the sequence starts over with Screen 2—Switch Test. Turning the self-test switch off at any time during the Self-Test Mode causes the game to return to the Attract Mode.

In all cases, push the player 1 start switch to move to the next test.

Screen 1—RAM/ROM Test

The RAM/ROM Test screen, as shown in Figures 2-1 and 2-2, provides a visual check of the game RAM, ROM, and associated circuitry. If the RAM and ROM test passes, the display will switch to Screen 2—Switch Test.

Screen 1 is divided into RAM and ROM test sections. The condition of the RAM circuitry is displayed in the bottom half of the screen. If no RAM errors were encountered, after about an eight-second delay the condition of the ROM circuitry is displayed in the top half of the screen. If there *were* RAM errors, press the player 1 start button to advance to the ROM test (this action clears any RAM errors from the screen).

If the ROM test fails, the error messages may appear in the top half of the screen as shown in Figure 2-1. Refer to Table 2-1 for the faulty ROM locations.



Figure 2-1 ROM Test Fails

If the upper or lower main memory ROM circuits on the Main PCB fail, an *Upper or Lower Main ROM error* message will appear at the top of the screen. Press the player 1 start button to obtain any RAM or ROM error message(s) from the Cartridge PCB RAM or ROM circuits. Press the player 1 start button again. If the bank switch ROM circuits

on the Cartridge PCB are faulty, the message *Bank Switch Error* will appear.

Table 2-1 Faulty ROM Locations

Error Message	Location
ROM at 10000 error	U = 13E L = 13D
ROM at 18000 error	U = 14E L = 14D
ROM at 20000 error	U = 15E L = 15D
ROM at 28000 error	U = 16E L = 16D

If the RAM test fails, the error messages appear as shown in Figure 2-2. To determine the location of the faulty RAM circuit, refer to the memory maps and schematic diagrams in the schematic package supplements for this manual and for the *System I Operators Manual*.

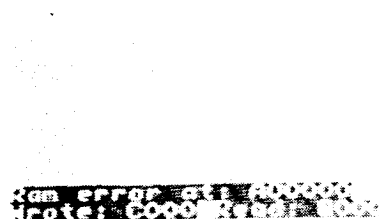

Figure 2-2 RAM Test Fails

Repair the faulty RAM or ROM circuit or press the player 1 start button to obtain Screen 2.

Screen 2—Switch Test

The Switch Test screen is shown in Figure 2-3. This screen indicates the condition of the player 2 start pushbutton switch. Press the player 2 start button and note that the first number changes to a 1.

Press the player 1 start button to obtain Screen 3.

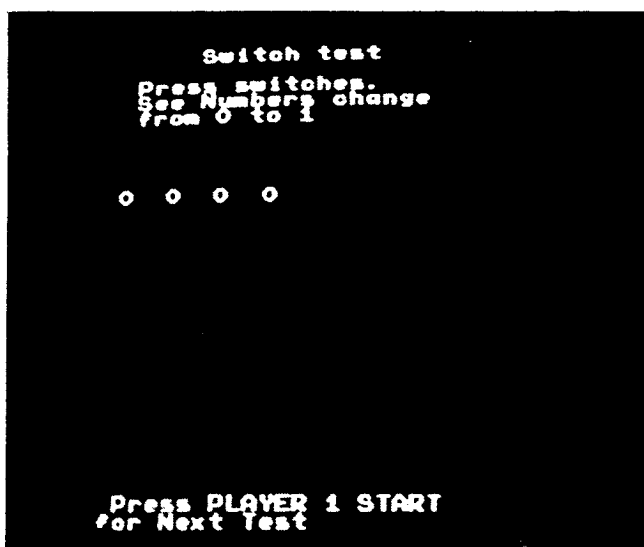

Figure 2-3 Switch Test

Screen 3—Coin Options

The Coin Options screen is shown in Figure 2-4. The Coin Options screen indicates the current coin-option settings and is used to change those settings. Refer to Table 2-2 for the available and recommended settings.

COIN MODE should have a red box around it. Move either Midi Trak-Ball right or left, and note that the coin mode values change. Select the desired value. Move the Midi Trak-Ball down to move the red box to **RIGHT MECH MULTIPLIER**. Move the Midi Trak-Ball right or left to cycle through all the available multiplier values. Select the desired value. Repeat this procedure for the remaining options.

Table 2-2 Coin Option Settings

Credit Mode	1 Coin 1 Credit ◀
	2 Coins 1 Credit
	3 Coins 1 Credit
	4 Coins 1 Credit
Right Mech Multiplier	1 Coin Counts as 1 Coin ◀
	1 Coin Counts as 4 Coins
	1 Coin Counts as 5 Coins
	1 Coin Counts as 6 Coins
Left Mech Multiplier	1 Coin Counts as 1 Coin ◀
	1 Coin Counts as 2 Coins
Bonus Adder	No Bonus Adder ◀
	2 Coins Give 1 Extra Coin
	4 Coins Give 1 Extra Coin
	4 Coins Give 2 Extra Coins
	5 Coins Give 1 Extra Coin
	3 Coins Give 1 Extra Coin
	Free Play

◀ Manufacturer's recommended settings.

If you wish to cancel the option changes and restore the original settings, press the player 2 start button.

Press the player 1 start button to set the game for the options selected and obtain Screen 4.

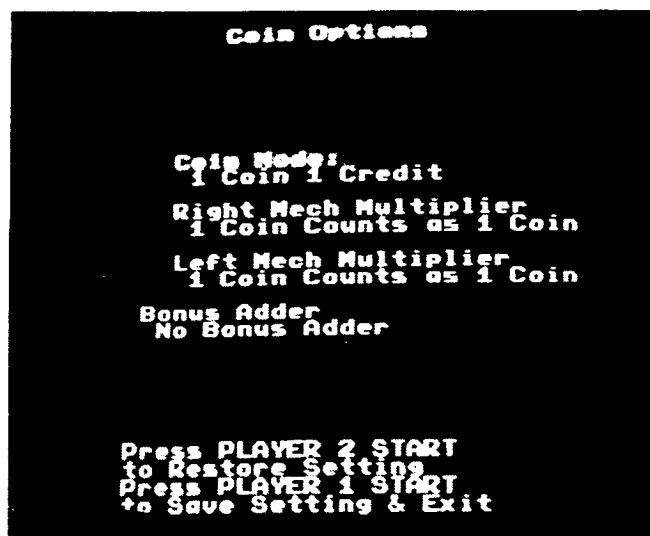

Figure 2-4 Coin Options

Screen 4—Game Options

The Game Options screen is shown in Figure 2-5. This screen indicates the current option settings. It is used to reset the high-score table and change the game option settings. Refer to Table 2-3 for the available options and the recommended settings. *Note that the recommended settings are displayed in green.*

Move either Midi Trak-Ball right or left and note that the settings for the option in the shaded block will change. Select the desired value. Move the Midi Trak-Ball up or down to move the desired option into the shaded block. Move the Midi Trak-Ball right or left to cycle through all the available option settings. Select the desired value. Repeat this procedure for the remaining options.

If you wish to cancel the option changes and restore the original settings, press the player 2 start button.

Press the player 1 start button to set the game for the options selected and obtain Screen 5.

Table 2-3 Game Option Settings

Option Name	Available Settings
Game Difficulty ¹	Very Easy Easy Normal ◀ Hard Very hard
Two-Player Continuation	½ credit required to continue 1 credit required to continue ◀ None
Sounds in Attract Mode?	Yes ◀ No
Reset High-Score Table?	Yes ² No

◀ Manufacturer's recommended settings.

¹ The Game Difficulty settings adjust the time allowed for completing each level of the game. For example, on the normal setting the player is given 60 seconds to complete Level 1. The other Difficulty Options will either add seconds (for easier) or subtract seconds (for harder) to the time allowed.

² If you select "Yes" and exit Screen 4 by pressing player start 1, the score stored in non-volatile RAM will be cleared and replaced by the manufacturer's default scores.

NOTE

If you have the 1st printing of ST-276 installed in your MARBLE MADNESS game, Table 3 has an error. Change the manufacturer's recommended setting to Sounds in Attract Mode—Yes.

Screen 5—Statistics

The Statistics screen appears as shown in Figure 2-6. The Statistics screen provides a visual check of the current game statistics. The statistics information is accumulated either from the first time the game was turned on or from the last time the statistics were reset. To reset the statistics information, press the player 2 start button.

The following information appears on the Statistics screen:

- *AUX COINS* is not used on the MARBLE MADNESS game.
- *LEFT COINS* shows the number of coins deposited in the left coin mechanism.
- *RIGHT COINS* shows the number of coins deposited in the right coin mechanism.
- *1 PLYR GAMES* shows the number of one-player games.
- *2 PLYR GAMES* shows the number of two-player games.
- *MINS PLAYED* shows the total time, in minutes, of all the games played.
- *MINS PWR UP* shows the total time, in minutes, that the game has been turned on.
- *AUX CNTR 1* through 3 show the number of games that reached level 4, 5, and 6 respectively.
- *ERROR COUNT* shows the number of EEPROM (location 15F on the Main PCB) errors that were detected. Replace the EEPROM at location 15F on the Main PCB if the errors detected exceed approximately 75 per week.
- *AVG GAME TIME* shows the average game time per coin in seconds.

Press the player 1 start button to obtain Screen 6.

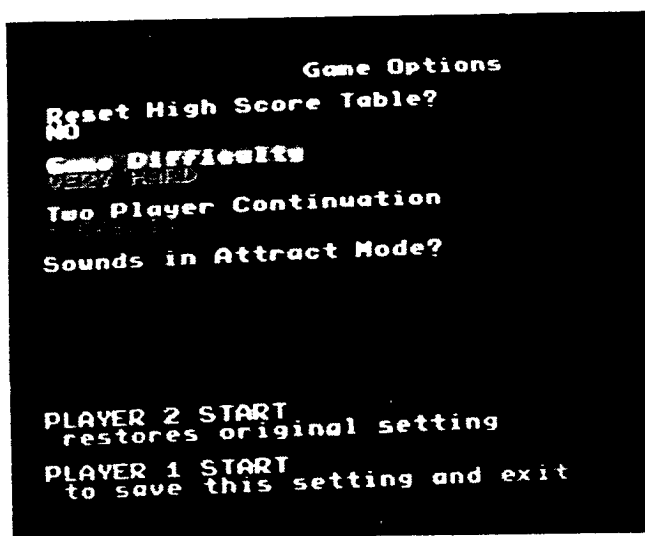

Figure 2-5 Game Options



Figure 2-6 Statistics

Screen 6—Histograms

Three Histogram screens are shown in Figure 2-7. The Histogram for Level 1, 2, and 3 screens are selected by pressing the player 1 start button. These screens provide a visual check of the game times, in seconds, from 0 to 240 for three levels of game play. Also displayed is the high score for each level.

- Level 1:* Records the game time in seconds for a one-player game.
- Level 2:* Records the game time of the winning player in a two-player game.
- Level 3:* Records the game time of the losing player in a two-player game.

The game times information is accumulated either from the first time the game was turned on or from the last time the game times were reset. To reset the Histograms, press the player 2 start button while displaying the Histogram screen for Level 3.

Press the player 1 start button to obtain Screen 7.



Figure 2-7 Histograms

Screen 7—Playfield Test

The Playfield Test screen appears as shown in Figure 2-8. The playfield displayed should not show any abnormalities. The playfield display indicates the condition of the graphics ROM.

Move either Midi Trak-Ball control to the left. The playfield should slowly scroll to the left. Move the Midi Trak-Ball controls up and the playfield will scroll up. Likewise for right and down. This tests the vertical and horizontal playfield scrolling registers, and the Midi Trak-Ball controls.

The numbers in the center of the playfield display indicate the condition of the bit plane 0 through 4 circuits. The numbers 0 through 3 should be four shades of gray with the lightest shade for the number 3. The number 4 should be red.

Press the player 1 start button to obtain Screen 8.

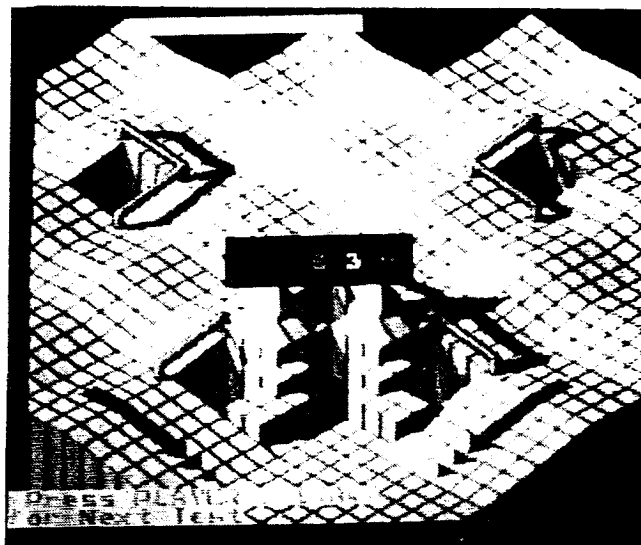

Figure 2-8 Playfield Test

Screen 8—Motion Object Test

The Motion Object Test screen appears as shown in Figure 2-9. The seven groups of eight motion objects should be identical and eight pixels high. The Motion Object Test screen indicates the condition of the motion-object buffer circuit.

Press the player 2 start button to select any of the 56 motion objects. If either Midi Trak-Ball is moved, the selected motion object should move in the same direction.

Press the player 1 start button to obtain Screen 9.

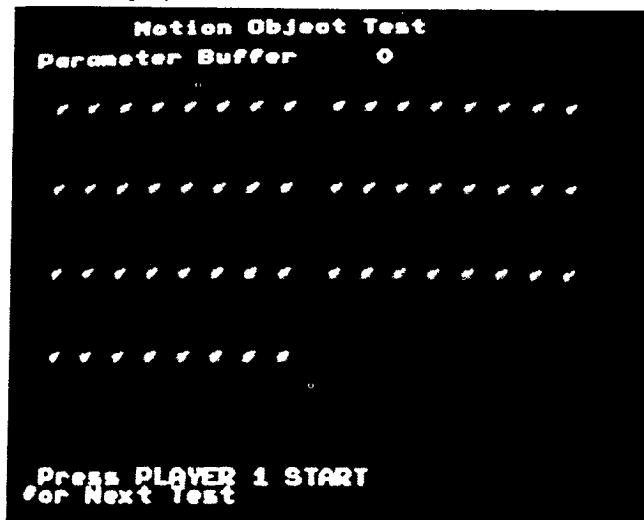

Figure 2-9 Motion Object Test

Screen 9—Motion Object Obscuring Test

The Motion Object Obscuring Test screen appears as shown in Figure 2-10. The Motion Object Obscuring Test screen indicates the condition of the graphic priority con-

trol circuit. Move either Midi Trak-Ball to move the motion object through the center of the display. The motion object should disappear and reappear on the opposite side of the shaded bar, and likewise when crossing through the open area in the middle of the shaded bar.

Press the player 1 start button to obtain Screen 10.

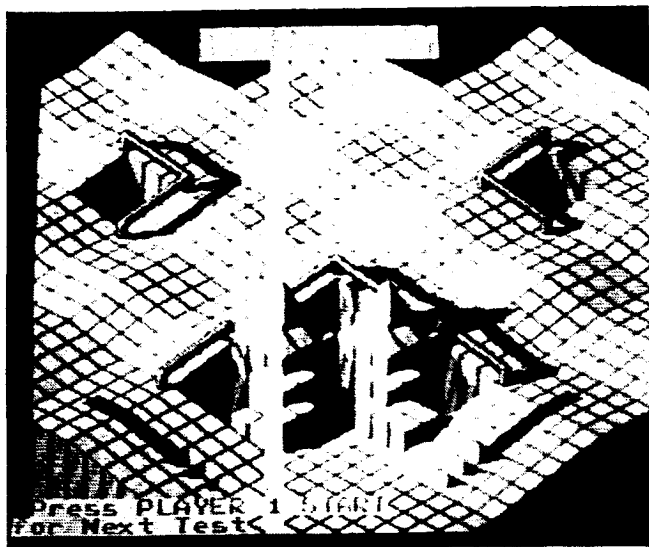

Figure 2-10 Motion Object Obscuring Test

Screen 10—Motion Object Height Test

The Motion Object Height Test screen appears as shown in Figure 2-11. The Motion Object Height Test screen indicates the condition of the motion object/playfield graphic address generator circuit.

Each successive column of motion objects should be eight pixels taller than the last. The top eight pixels of all the columns should be the same. The top 16 pixels of all the columns that are at least 16 pixels high should be the same. Each column should add a new 8×8 pixel stamp picture to the bottom and slide the old picture up by eight pixels.

Press the player 2 start button to select any of the 16 motion objects. Move either Midi Trak-Ball, and the selected motion object should move in the same direction.

Press the player 1 start button to obtain Screen 11.



Figure 2-11 Motion Object Height Test

Screen 11—Alpha Test

The Alpha Test screen should appear as shown in Figure 2-12. The Alpha Test screen indicates the condition of the alphanumeric circuit.

Press the player 1 start button to obtain Screen 12.

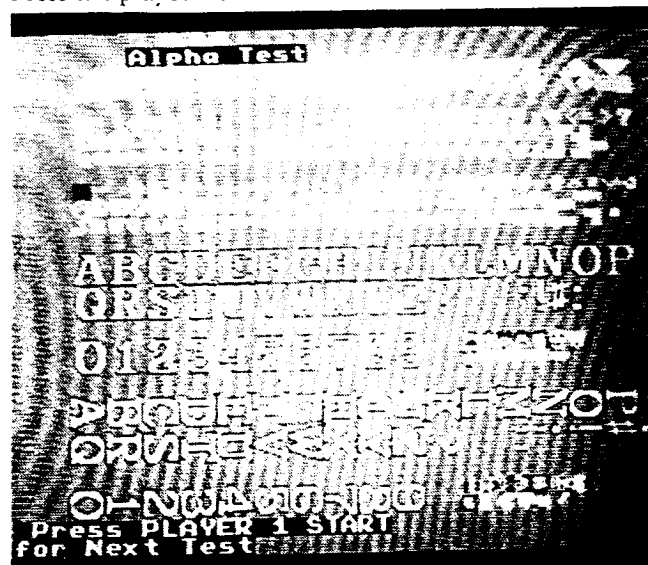

Figure 2-12 Alpha Test

Screen 12—Color Test 1

The Color Test screen appears as shown in Figure 2-13. The Color Test screen indicates the condition of the display color circuits.

There should be eight vertical gray-scale bars and three groups of eight horizontal bars with shades of red, green, and blue. The brightest bars should be on the left and darkest (black) on the right with a bright white frame around the screen. This frame will help to identify the darkest col-

or band. If the display characteristics are not correct, refer to the display manual for the color-gun adjustment procedure or to determine the possible cause of failure.

Press the player 1 start button to obtain Screen 13.

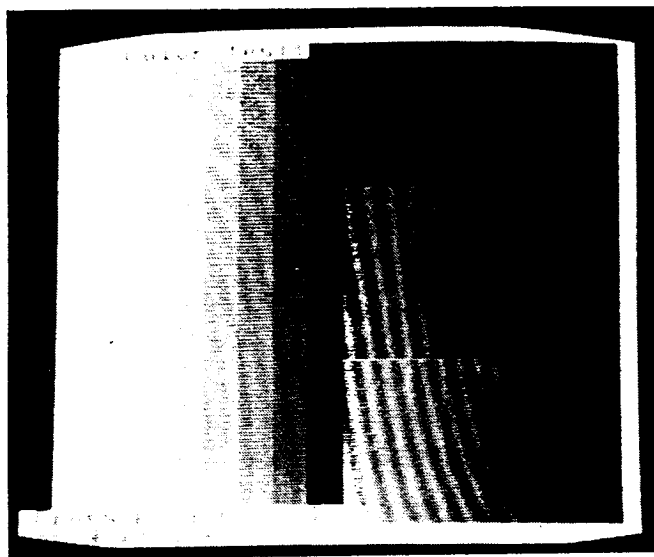

Figure 2-13 Color Test

Screen 13—Color Purity Test

The Color Purity Test consists of five color displays that indicate the condition of the display color-purity circuits. The first display to appear should be a red screen with the word RED displayed at the bottom of the screen as shown in Figure 2-14.

Press the player 2 start button and the next display to appear should be green with the word GREEN displayed at the bottom of the screen. Press the player 2 start button to obtain a blue, white, and finally a gray screen. After the gray screen, the display will repeat the red, green, blue, white, and gray sequence again.

If the display characteristics are not correct, refer to the display manual for the color-purity adjustment procedure or the possible cause of failure.

Press the player 1 start button to obtain Screen 14.

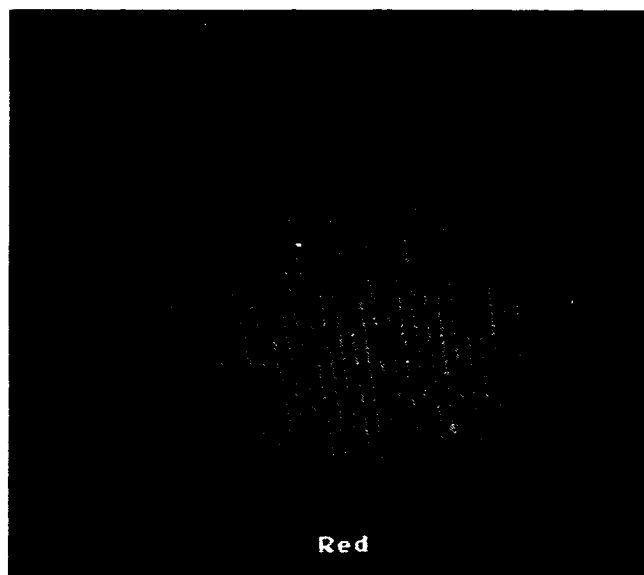

Figure 2-14 Color Purity Test

Screen 14—Convergence Test

The Convergence Test screen appears as shown in Figure 2-15. The grid pattern should be white. The Convergence Test screen indicates the condition of the display size, centering, linearity, and convergence.

Press the player 2 start button and the pattern should turn violet. Repeated pressing of the player 2 button should cause the screen to alternate between violet and white. Examine the grid pattern for the following characteristics (the violet and white patterns are used to adjust the display convergence):

- Only two adjacent sides of the grid pattern should touch the edges of the screen.
- Grid lines should show no pincushioning or barreling, and the lines should be straight within 3.0 mm.
- Violet and white pattern convergence should be within 2.0 mm.

If the display characteristics are not within these limits, refer to the display manual for the linearity and convergence adjustment procedures or to determine the possible cause of failure.

Move the Midi Trak-Ball up, and the pattern should slowly scroll up the screen. Moving the Midi Trak-Ball left, right, or down should cause the pattern to scroll accordingly.

Press the player 1 start button to obtain Screen 15.

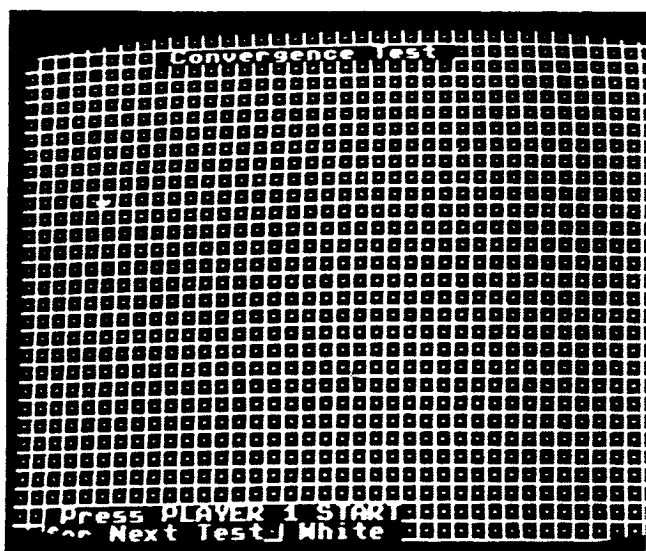

Figure 2-15 Convergence Test

Screen 15—Sound Test

The Sound Test screen should appear as shown in Figure 2-16. The Sound Test screen indicates the condition of the coin mechanisms and the music and sound-effects circuits.

The sound microprocessor is reset at the beginning of this test which may take several seconds. If the sound-microprocessor reset fails, the message **SOUND PROCESSOR NOT RESPONDING** should blink near the top of the screen. Move the Midi Trak-Ball up to sequence through the sounds. Move the Midi Trak-Ball down to sequence through the sounds backwards. The Sound Test screen provides the following sound information:

- **CURRENT COIN VALUE** consists of three zeros. As coins are deposited in each of the coin mechanisms, the second and third zero should change to a 1 as the coin switch is held down and change back to zero when the coin switch is released.
- **NUMBER OF SOUNDS** consists of the number of sounds used in the MARBLE MADNESS game.
- **SOUND CPU STATUS** indicates the condition of the sound microprocessor. If the sound microprocessor is good, the word *Good* should appear. If the sound microprocessor is faulty, **SOUND CPU ROM 1** or **2 ERROR** appears at the top of the screen. Other error messages are probable:
SOUND CPU RAM 1 ERROR
SOUND CPU RAM 2 ERROR
SOUND CPU INTERRUPT ERROR
MUSIC CHIP TIME OUT
SPEECH CHIP TIME OUT
- **MUSIC CHIP TEST** consists of eight tones in a major scale that alternate between sound channels (16 total tones).

- **EFFECTS CHIP TEST** consists of four tones in a major chord that come from both sound channels simultaneously.

Press the player 1 start button to obtain Screen 16.

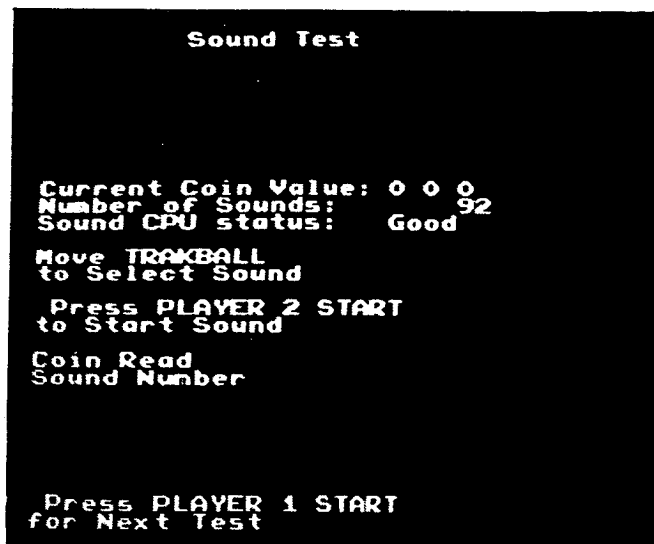

Figure 2-16 Sound Test

Screen 16—Color Palette Test

The Color Palette Test appears as shown in Figure 2-17. The Color Palette Test screen indicates the condition of the graphic palette select circuit. The eight motion objects and the four playfield stamps should each be a different color.

Press the player 1 start button to return to Screen 2—Switch Test or turn off the self-test switch to return to the Attract Mode.

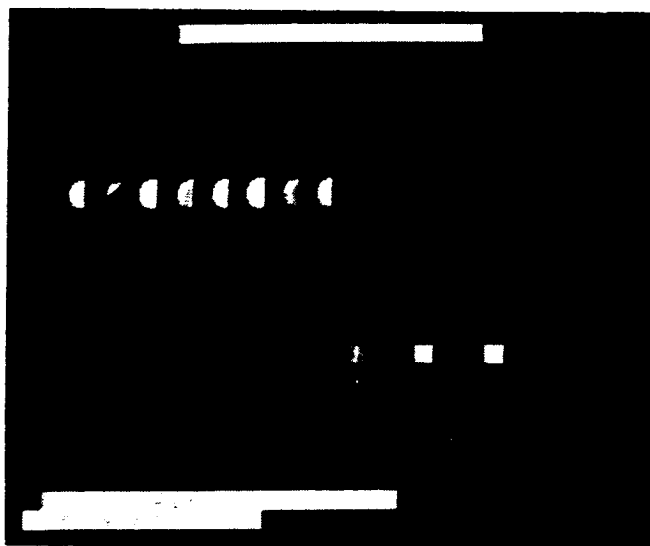

Figure 2-17 Color Palette Test

Maintenance

Maintenance consists of removing, disassembling, re-assembling, and replacing the Midi Trak-Ball, player-start pushbutton switches, and the Cartridge PCB.

This chapter includes maintenance procedures for the MARBLE MADNESS controls and for the Cartridge PCB. To assure maximum trouble-free operation from this game, we recommend that maintenance be performed as described in this chapter and in the System I™ operators manual.

Maintenance for the MARBLE MADNESS game includes inspecting, cleaning, and lubricating the Midi Trak-Ball™. How often maintenance is performed depends upon the game environment and frequency of play. However, we recommend that maintenance be performed on the Midi Trak-Ball at least every three months.

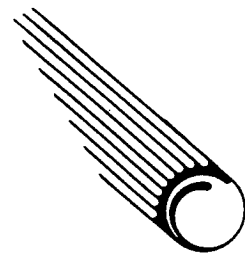

Chapter 3

Removing the Control Panel

Perform the following procedure to remove/replace the control panel (see Figure 3-1).

1. Unlock and open the coin door on the front of the cabinet.
2. Carefully reach through the coin door opening and release the spring-draw latch located under the control panel on the right side of the cabinet.
3. Unlock and remove the front-access panel.
4. Reach through the front access-panel opening and disconnect the control-panel harness from the top of the Main PCB.
5. Carefully reach up under the top of the front access-panel opening and release the spring-draw latch located under the control panel on the left side of the cabinet.
6. From underneath, push up on the front edge of the control panel to free the panel from the slot in the cabinet.
7. Disconnect the green ground wire from the control panel harness and remove the control panel from the cabinet.
8. Replace the control panel in the reverse order of removal.

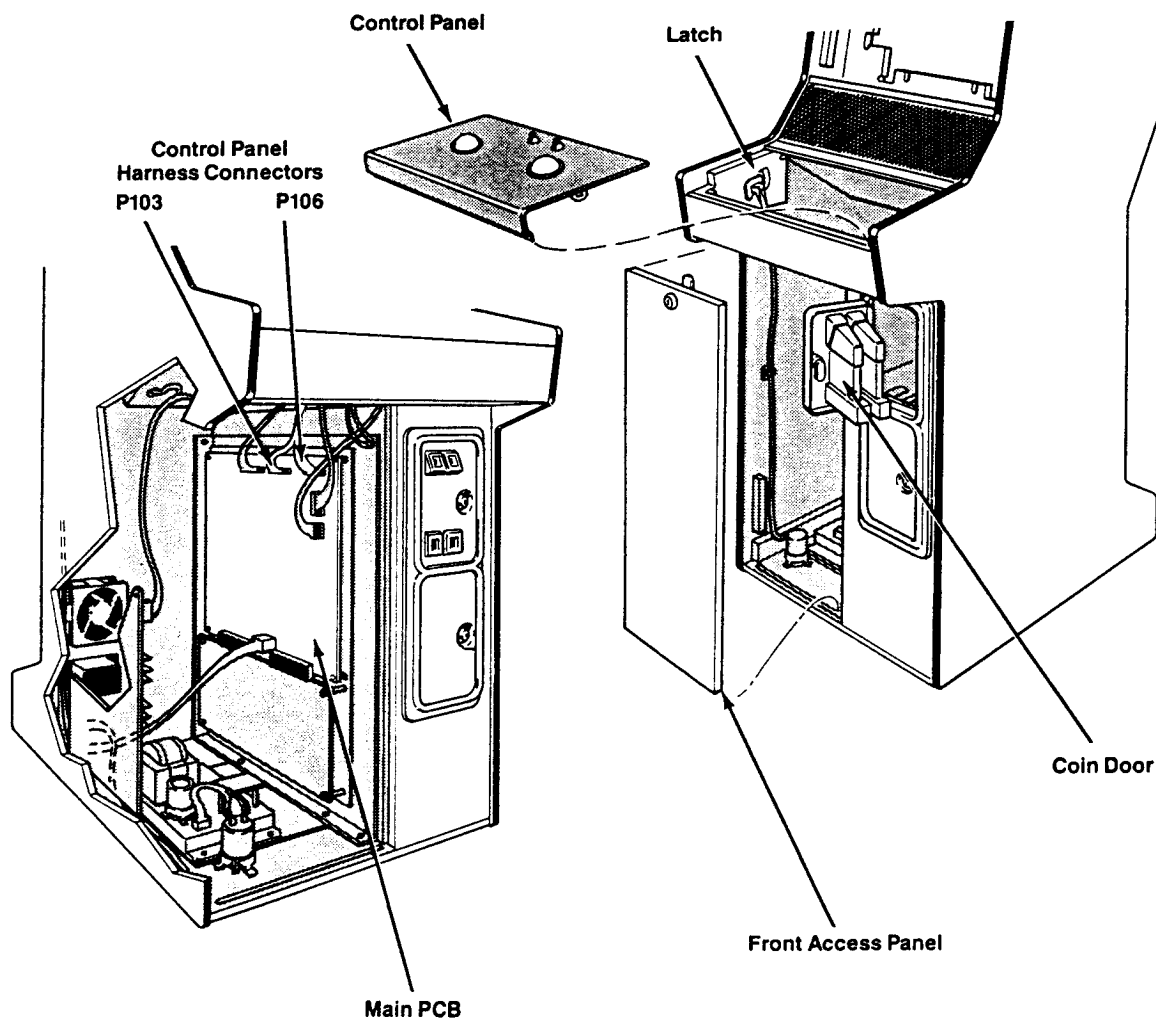

Figure 3-1 Control Panel Removal

Removing the Midi Trak-Ball

Perform the following procedure to remove/replace the Midi Trak-Ball from the control panel (see Figure 3-2).

1. Remove the control panel as previously described.
2. Disconnect the Trak-Ball harness from the control panel harness.
3. Use a $\frac{3}{8}$ -inch wrench to remove the four nuts and carriage bolts securing the Midi Trak-Ball to the control panel.
4. Replace the Midi Trak-Ball in the reverse order of removal. Make sure the Trak-Ball harness connector is connected to the Control Panel harness as shown in Figure 3-2.

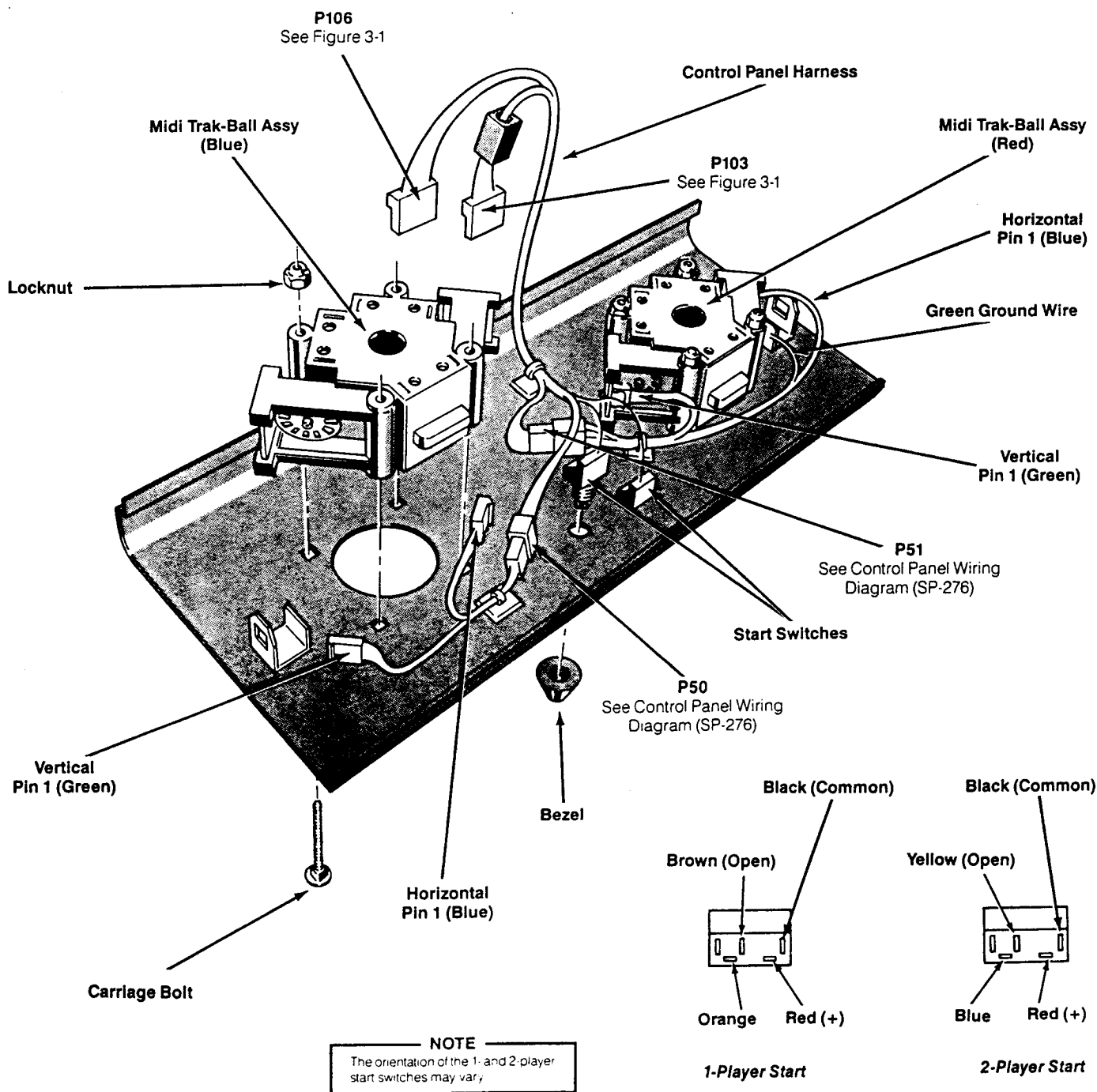

Figure 3-2 Removing the Midi Trak-Ball and Start Switches

Disassembling the Midi Trak-Ball

Perform the following procedure to disassemble/reassemble the Midi Trak-Ball (see Figure 3-3).

1. Remove the Midi Trak-Ball from the control panel as previously described.
2. Use a Phillips screwdriver to remove the six screws and washers securing the upper and lower frames.
3. Lift off the upper frame.
4. Remove the roller shaft from the lower frame.
5. Use a $\frac{3}{32}$ -inch hex driver to remove the socket-head screw, flat washer, and split-lock washer securing the metal encoding wheel to the shaft.
6. Remove the bearings from the ends of the roller shaft.
7. Remove the idler shaft from the lower frame.
8. Remove the bearings from the ends of the idler shaft.
9. Lift the Coupler PCBs out of the slot in the lower frame.
10. Reassemble the Midi Trak-Ball in the reverse order of disassembly. Tighten the encoding wheels by inserting a $\frac{1}{8}$ -inch diameter pin or screwdriver through the hole in the roller shaft and tighten the socket-head screw with a $\frac{3}{32}$ -inch hex driver.
11. Replace the Midi Trak-Ball as previously described.

NOTE

When you reinstall the Coupler PCBs, make sure the metal encoding wheels are not bent or damaged. Make sure the encoding wheels turn freely between the two halves of the radial optical couplers.

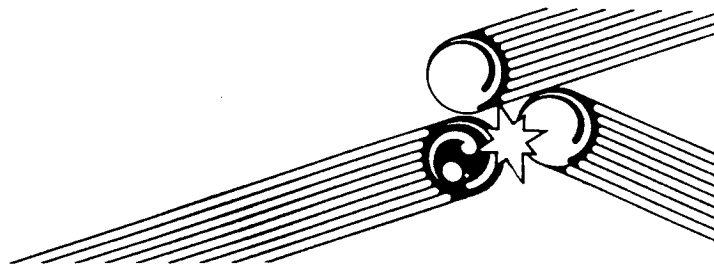

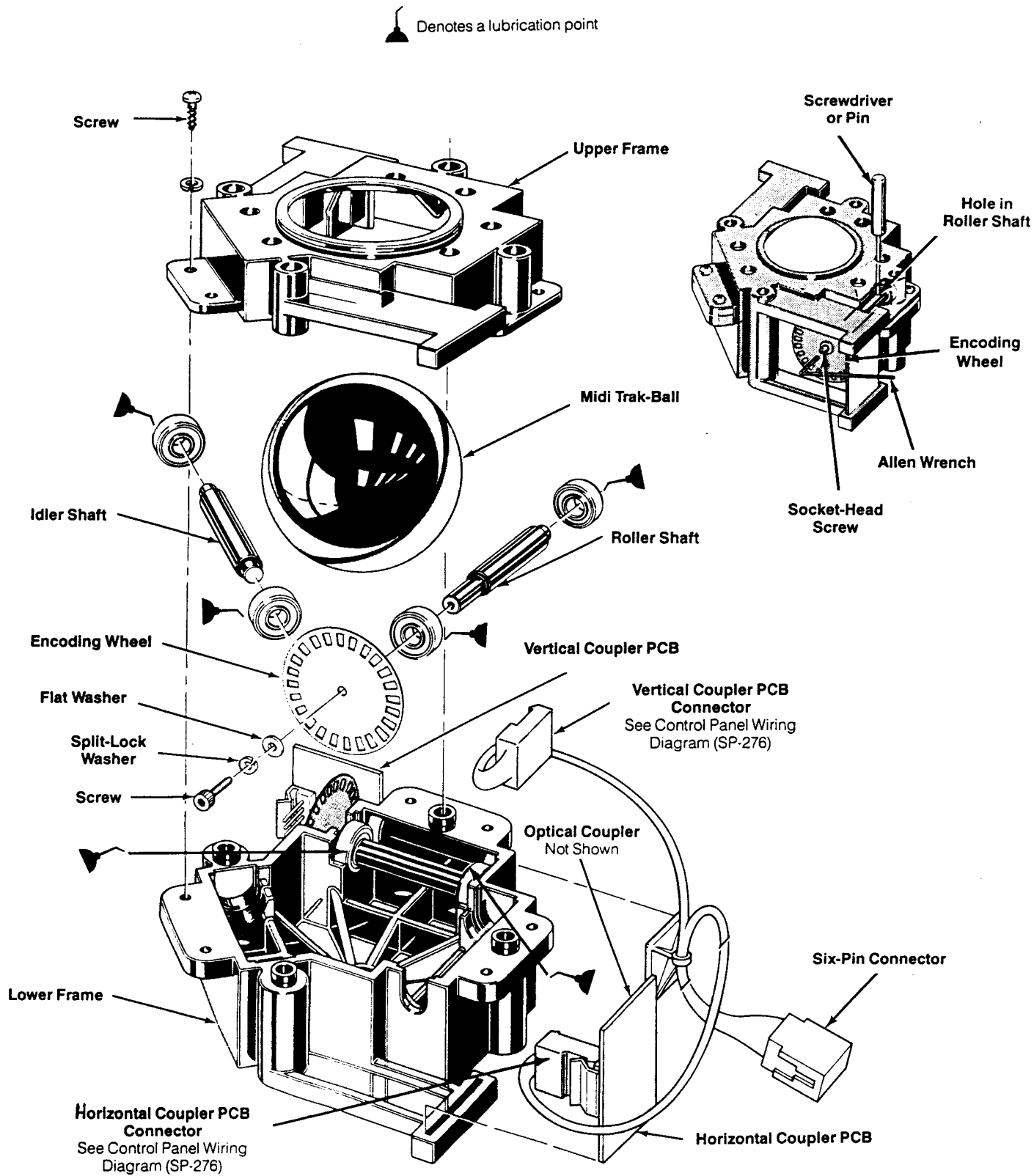

Figure 3-3 Midi Trak-Ball Disassembly and Lubrication

Inspecting and Lubricating the Midi Trak-Ball and Shafts

Maintenance on the Midi Trak-Ball consists of inspecting the roller and idler shafts for excessive wear, and lubricating the shaft bearings.

Perform the following procedure to inspect and lubricate the roller and idler shafts (see Figures 3-3 and 3-4).

1. Remove the control panel as previously described.
2. Remove and disassemble the Midi Trak-Ball from the control panel as previously described.
3. Inspect the roller and idler shafts for excessive wear as shown in Figure 3-4. If the wear band exceeds $\frac{3}{8}$ inch, remove and replace the shaft.

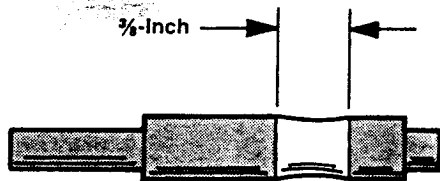

Figure 3-4 Roller and Idler Shaft Wear

4. To lubricate, place two drops of a light-duty oil, such as 3-In-One® oil, on each of the six ball bearings as shown in Figure 3-3.
5. Reassemble the Midi Trak-Ball in the reverse order of disassembly. Refer to the disassembly procedure.

Removing the Player-Start Switches

Perform the following procedure to remove/replace the player-start pushbutton switches (see Figure 3-2).

NOTE

Player-start switches can be checked for proper operation with an ohmmeter. Disconnect the wires from the switch terminals and connect an ohmmeter between the normally open and common contacts. Press and release the pushbutton and check for zero and infinite resistance. If the switch is not operating properly, perform the following procedure.

1. Remove the control panel as previously described.
2. Disconnect the four wires from the player-start switch terminals.
3. Turn the back of the switch counterclockwise with one hand while firmly holding the cone-shaped bushing on the front panel with the other hand.
4. Replace the player-start switch in the reverse order of removal. Connect the four wires to the switch terminals as shown in Figure 3-2.

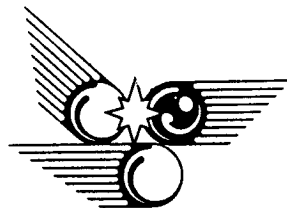

Removing the Cartridge PCB

Perform the following procedure to remove/replace the Cartridge PCB (see Figure 3-5).

NOTE

The procedure for removing the Main PCB is included in the Maintenance chapter of the System I operators manual.

1. Turn the cabinet power off.
2. Unlock and remove the front-access panel from the cabinet.
3. Disconnect the harness connectors from the Main PCB.
4. Use a Phillips screwdriver to remove the four screws securing the ground plane to the cabinet.
5. Carefully remove the ground plane, with the PCB(s) attached, and place on a clean surface.
6. Use a Phillips screwdriver to remove the four screws securing the Cartridge PCB to the ground plane.
7. Gently disconnect the Cartridge PCB from the Main PCB.
8. Connect the Cartridge PCB to the Main PCB.
9. Secure the Cartridge PCB to the ground plane and replace the ground plane, with the PCBs attached, in the cabinet. Make sure that the Cartridge PCB is fully inserted into the Main PCB edge connectors and the ground strap is properly connected to the ground plane. Refer to Figure 3-5 for the ground strap and harness connector locations.

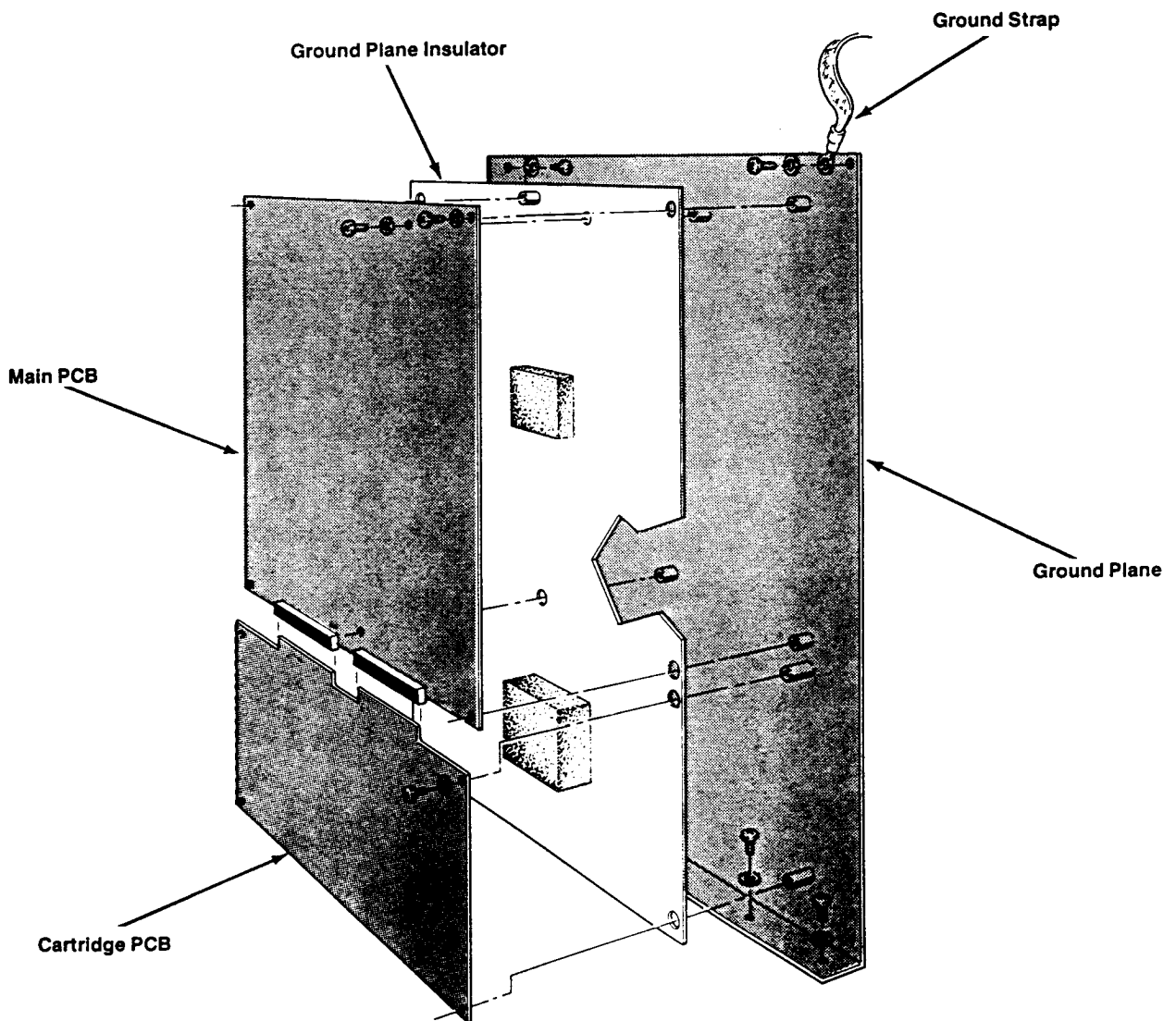
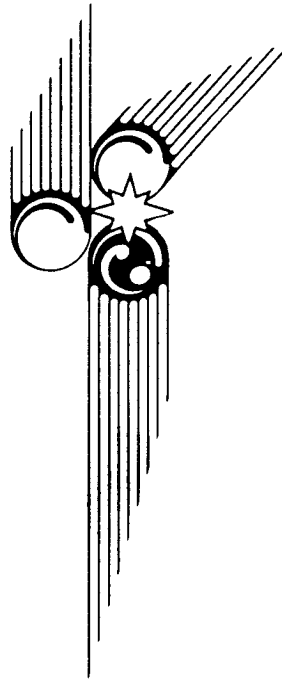

Figure 3-5 Removing the Cartridge PCB

Game Play

This chapter describes the three modes of operation for the MARBLE MADNESS game: Attract, Play, and High-Score. Also included are Hints for Game Play and Maximizing Earnings.



Introduction

MARBLE MADNESS is a one- or two-player game. Two players can play at the same time and compete to reach the goal first. The player controls a red marble or a blue marble via the correspondingly colored Trak-Ball™ controls.

The player's main goal is to race toward the goal in minimum time by maneuvering his red or blue marble along treacherous paths high atop the unique cubic raceway. The timer ticks away and ends the game if the player does not reach the goal in the allotted time. Numerous obstacles and unfriendly creatures on the raceway try to destroy the marble. The marble will always magically reappear, but, of course, several precious seconds on the timer are lost.

Attract Mode

The Attract Mode begins either when the game is plugged in or after exiting the Play, High-Score, or Self-Test Modes. The Attract Mode ends when the correct amount of coins or tokens are inserted and the one- or two-player start button is pressed, or when the self-test switch is turned off. The Attract Mode continuously cycles through the following events:

- Game Play Demonstration on Raceway One
- High-Score Table Display
- Game Play Demonstration on Raceway Two
- High-Score Table Display
- Audio/Visual Credits Display

Play Mode

As the action begins, the player skillfully maneuvers the blue or red marble down the raceway, through numerous obstacles, toward the goal. As the player nears the bottom of the screen, the raceway automatically scrolls upward, revealing more of the raceway. Note that in a one-player game, only the blue ball is active on the screen, but either the blue or red Trak-Ball may be used to maneuver the blue marble.

Upon reaching the goal area, action briefly stops while the player's points are tallied. Bonus points are awarded for unused seconds on the timer and for finishing the race without losing a marble off the edge of a cliff. In the two-player game, the players can race along cooperatively, each going for maximum points, or they can compete by bumping each other into hazards or off the cliffs.

The action resumes on Raceway Two where the player encounters the first adversaries; the Black Steelie and the Green Marble Munchers. The Black Steelie and the Marble Munchers' sole purpose is to try to block the way to the goal. Remember, the player must reach the goal before the timer runs out to advance to the next raceway! The player can complete six different raceways, each successive one requiring more skill.

High-Score Mode

Upon completion of a game, and if their score is among the top ten scores recorded in the game, the player(s) have 45 seconds to enter their initials in the High Rollers table. Select initials by rolling the Trak-Ball and pressing a player-start button when the proper initial is displayed. Players can correct their initials by selecting the arrows that point in the desired direction and pressing a player-start button. Then repeat the procedure for entering initials.

Hints for Game Play

The following hints enable you to get the edge over your competition.

- Anticipate your next move and start the Trak-Ball rolling in that direction ahead of time.
- Complete each raceway as fast as possible because extra seconds mean extra points, and the extra time from one raceway is carried over to the next raceway.
- Try to maneuver around the Black Steelie, or try to bump him off a cliff to get rid of him permanently.
- Move quickly to avoid being swallowed by the green Marble Munchers.
- Watch for patterns, and time your movements right to pass by difficult obstacles.
- Some raceways have alternate paths, so explore a bit and you may find an easier way to reach the goal. Bonus points are given for paths which are more difficult.

Maximizing Earnings

The key to maximum earnings is to strike a mid-point on game times. Game times must be short enough that player turnover is high, but at the same time, they must be long enough to give the player good value and insure repeat play—which is crucial to longevity. MARBLE MADNESS gives the operator the flexibility to adjust game difficulty, and enough statistics to make intelligent adjustments.

Use the self-test screens showing statistics/histograms and the Game Options Screen to make adjustments. If collections seem low or are dropping off, observe game times on the histograms.

If most game times are under 90 seconds, change the difficulty option to an easier setting.

If most game times are over 150 seconds, change difficulty to a harder setting.

After changing difficulty settings, always clear or reset the statistics by pressing the player 2 start button in the Statistics Screen.

Illustrated Parts Lists

This chapter provides information you need to order parts for your game. Common hardware (screws, nuts, washers, etc.) has been deleted from most of the parts lists. However, a parts list is included for the hardware to mount the printed-circuit boards (PCBs) to the cabinet.

The PCB parts lists are arranged in alphabetical order by component. Each component subsection is arranged alphanumerically by reference designator.

Other parts lists are arranged alphanumerically by Atari part number. In these parts lists, all A-prefix numbers appear first. Following these are numbers in sequence evaluated up to the hyphen, namely 00- through 99-, then 000598- through approximately 201000-.

When ordering parts, please give the part number, part name, number of this manual, and serial number of your game. This will aid in filling your order rapidly and correctly. We hope the results will be less downtime and more profit from your game.

Atari Games, Inc. Customer Service numbers are listed on the inside front cover of this manual.

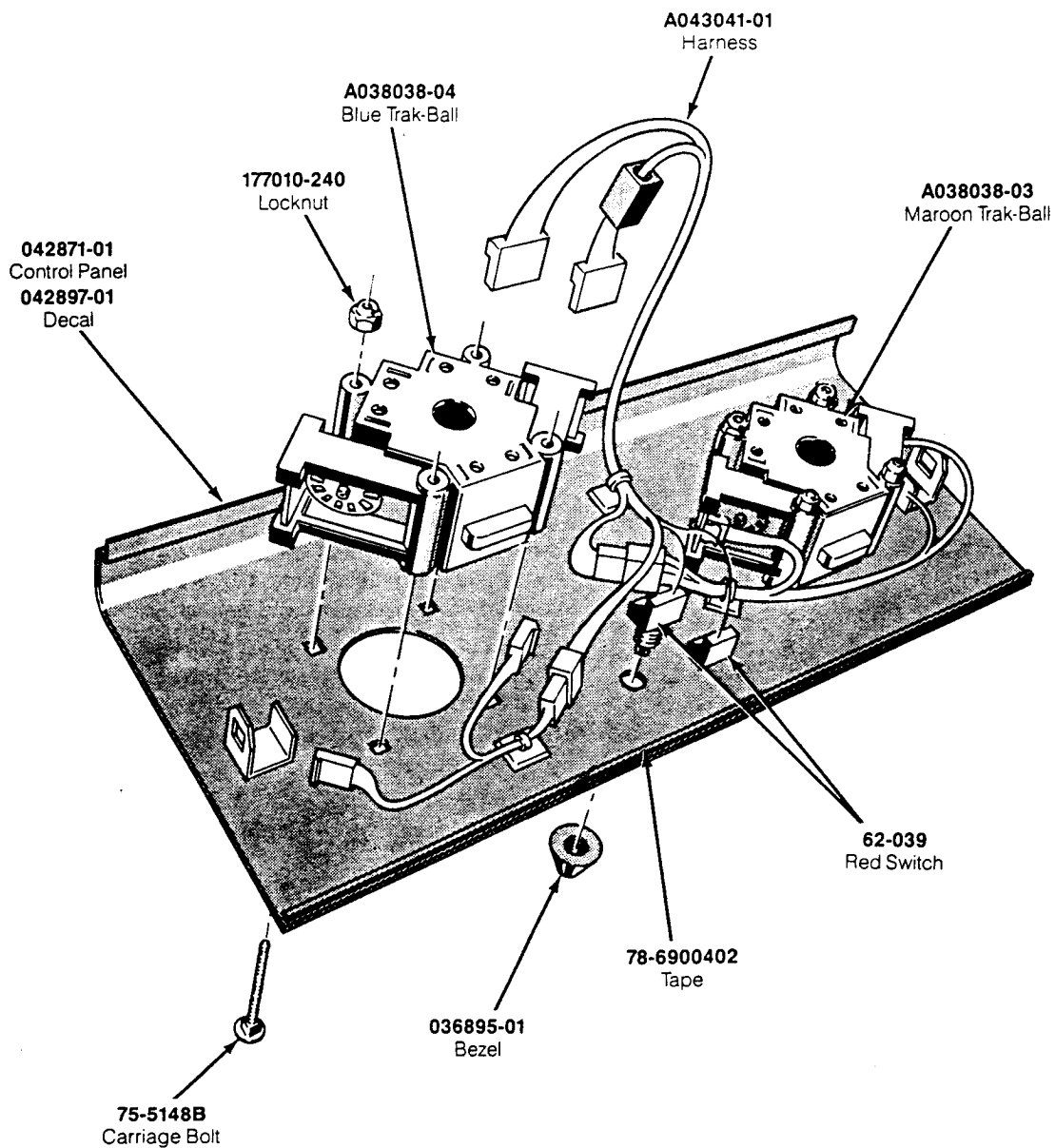
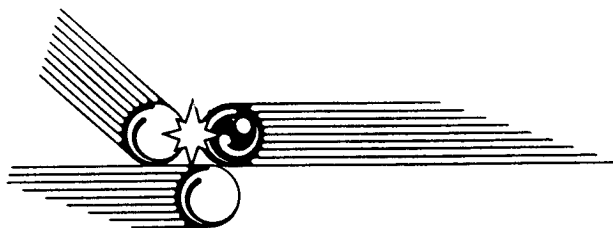

Figure 5-1 Control Panel Assembly
A042872-01 A

Control Panel Assembly Parts List

Part No.	Description
A043041-01	Control Harness Assembly
A038038-03	Midi Trak-Ball Assembly (Maroon—right side)
A038038-04	Midi Trak-Ball Assembly (Blue—left side)
036895-01	Black Molded Bezel
042871-01	Control Panel
042897-01	Control Panel Decal
177010-240	#10-24 Hex Locknut
62-039	Red Cap Switch
75-5148B	#10-24 × 3-Inch-Long Black Carriage Bolt
78-6900402	¼-Inch × ⅝-Inch Foam Tape



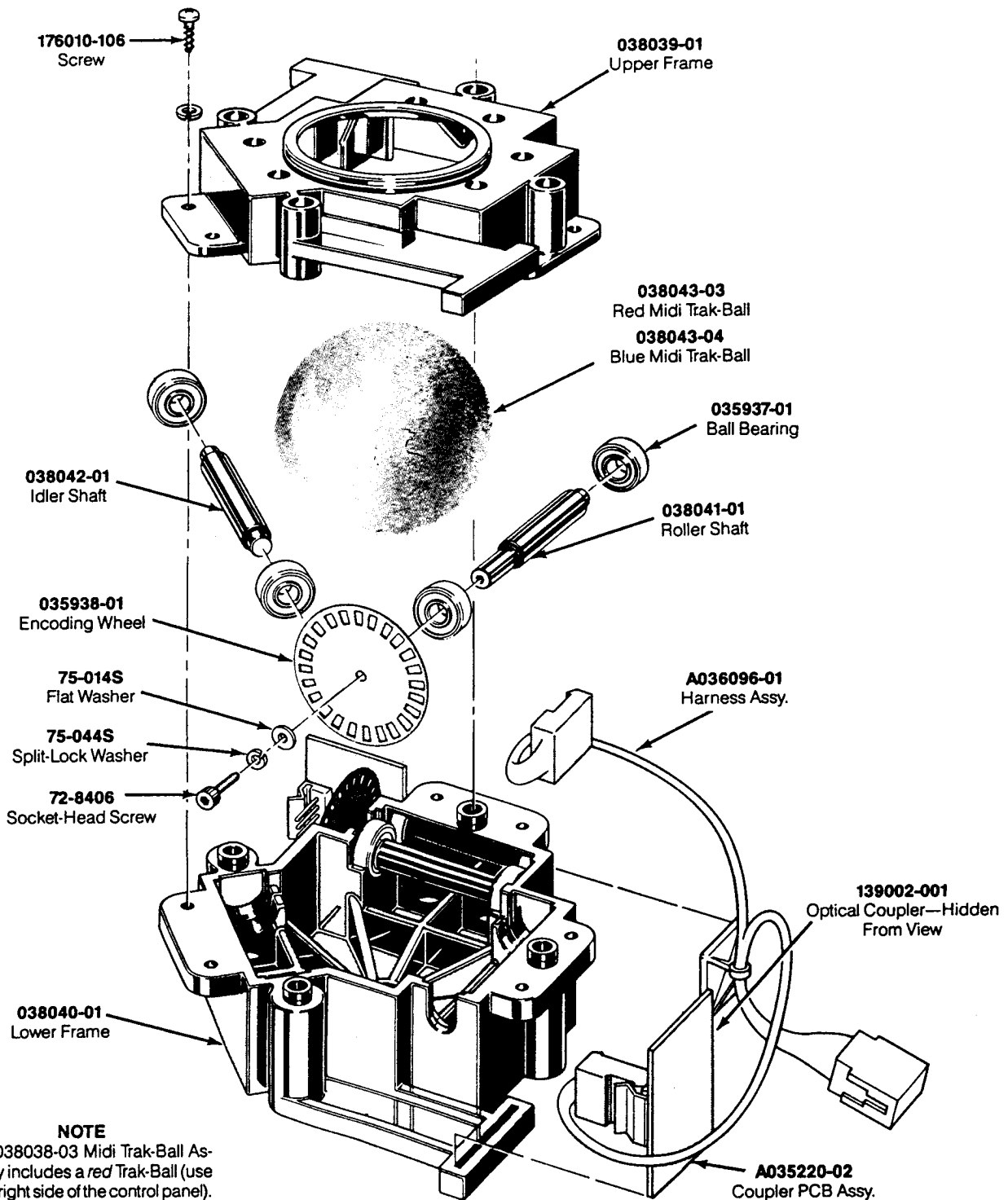
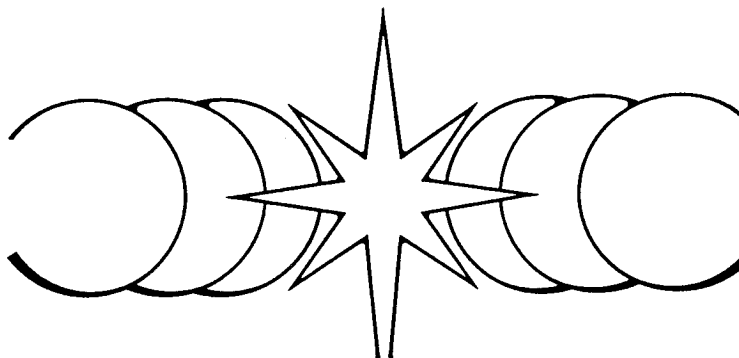

Figure 5-2 Midi Trak-Ball™ Assembly
A038038-xx B

Midi Trak-Ball™ Assembly Parts List

Part No.	Description
A035220-02	Coupler PCB Assembly (includes Radial Optical Coupler)
139002-001	Radial Optical Coupler
A036096-01	Harness Assembly
72-8406	#4-40 × $\frac{3}{8}$ -Inch, Hex Socket-Head Steel Machine Screw
75-014S	#4 Flat SAE-Standard Zinc-Plated Steel Washer
75-044S	#4 Split-Lock Zinc-Plated Steel Washer
035937-01	Ball Bearing (6 per assembly)
035938-01	Etched Encoding Wheel
038039-01	Upper Black Plastic Frame
038040-01	Lower Black Plastic Frame
038041-01	Roller Shaft
038042-01	Idler Shaft
038043-03	Red Midi Trak-Ball (3-inch diameter)
038043-04	Blue Midi Trak-Ball (3-inch diameter)
176010-106	#8 × $\frac{3}{8}$ -Inch Cross-Recessed Pan-Head Steel Screw
107013-001	3-In-One Oil Lubricant



NOTICE TO ALL PERSONS RECEIVING THIS DRAWING
 CONFIDENTIAL. Reproduction for distribution without the specific written permission of Atari Games, Inc., Sunnyvale, CA. This drawing is only conditionally issued, and neither receipt nor possession confers or transfers any right in, or license to use, the subject matter of the drawing or any design or technical information shown therein, nor any right to reproduce this drawing or any part thereof. Except for manufacture by vendors of Atari Games, Inc., and for manufacture under the corporation's written license, no right is granted to reproduce this drawing or the subject matter thereof, unless by written agreement with or written permission from the corporation.

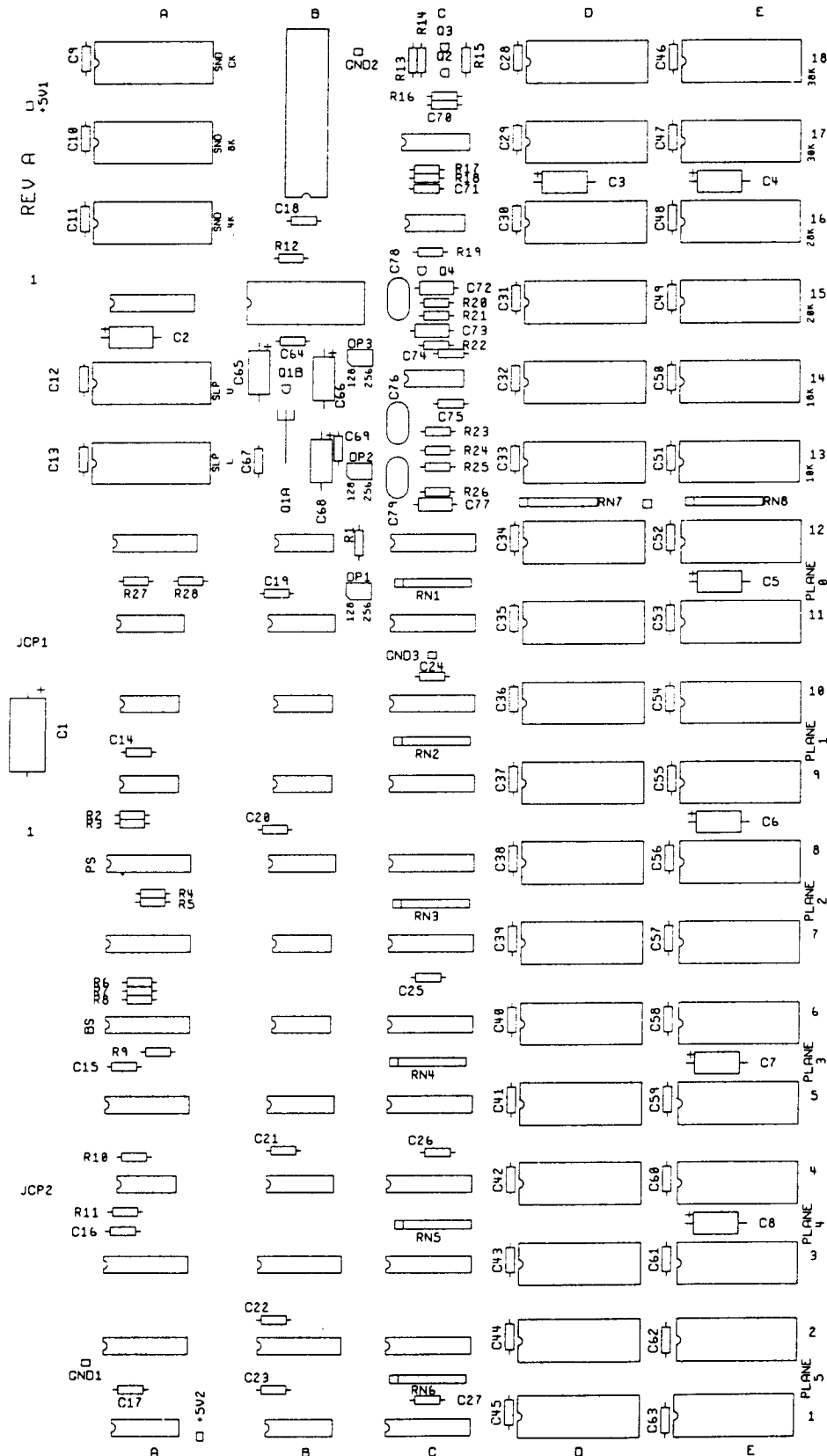

**Figure 5-3 Cartridge Printed-Circuit Board Assembly
 A043026-01 A**

Cartridge Printed-Circuit Board Assembly Parts List

Designator	Description	Part No.
Capacitors		
C1	25V, 100 μ F, Electrolytic Capacitor	24-250107
C2-8	50V, 4.7 μ F, Electrolytic Capacitor	24-500475
C9-64	50V, 0.1 μ F, Ceramic Capacitor	122002-104
C65-66	35V, 10 μ F, Electrolytic Capacitor	24-350106
C67	50V, 0.1 μ F, Ceramic Capacitor	122002-104
C69-71	50V, 0.1 μ F, Ceramic Capacitor	122002-104
C72-73	25V, 0.22 μ F, Ceramic Capacitor	122002-224
C74-75	50V, 0.1 μ F, Ceramic Capacitor	122002-104
C76	100V, 1000 pF, Mica Capacitor	128002-102
C77	25V, 0.22 μ F, Ceramic Capacitor	122002-224
C78-79	100V, 1000 pF, Mica Capacitor	128002-102
Read-Only Memories		
2E	Type-23256 300ns ROM Integrated Circuit	136033-114
4E	Type-23256 300ns ROM Integrated Circuit	136033-113
6A	Type-27S29 PROM Integrated Circuit	136033-118
6E	Type-23256 300ns ROM Integrated Circuit	136033-112
8A	Type-27S29 PROM Integrated Circuit	136033-119
8D	Type-23256 300ns ROM Integrated Circuit	136033-117
8E	Type-23256 300ns ROM Integrated Circuit	136033-111
10D	Type-23256 300ns ROM Integrated Circuit	136033-116
10E	Type-23256 300ns ROM Integrated Circuit	136033-110
12D	Type-23256 300ns ROM Integrated Circuit	136033-115
12E	Type-23256 300ns ROM Integrated Circuit	136033-109
13A	Type-23128 200ns ROM Integrated Circuit	136033-108
13D	Type-23256 300ns ROM Integrated Circuit	136033-102
13E	Type-23256 200ns ROM Integrated Circuit	136033-101
14A	Type-23128 200ns ROM Integrated Circuit	136033-107
15A	Slapstic Integrated Circuit	137412-103
15D	Type-23256 200ns ROM Integrated Circuit	136033-104
15E	Type-23256 200ns ROM Integrated Circuit	136033-103
16A	Type-23128 300ns ROM Integrated Circuit	136033-120
17A	Type-23128 300ns ROM Integrated Circuit	136033-121
17D	Type-23256 200ns ROM Integrated Circuit	136033-106
17E	Type-23256 200ns ROM Integrated Circuit	136033-105
18A	Type-23128 300ns ROM Integrated Circuit	136033-122
Integrated Circuits		
1A	Type-74LS157 Integrated Circuit	37-74LS157
1B	Type-74LS157 Integrated Circuit	37-74LS157
1C-12C	Type-74LS299 Integrated Circuit	137180-001
2A, 3A	Type-74LS374 Integrated Circuit	37-74LS374
2B, 3B	Type-74LS374 Integrated Circuit	37-74LS374
4A	Type-74LS125 Integrated Circuit	137317-001
4B	Type-74LS157 Integrated Circuit	37-74LS157
5A	Type-74LS244 Integrated Circuit	37-74LS244

(continued on next page)

Cartridge Printed-Circuit Board Assembly Parts List, continued

Designator	Description	Part No.
5B	Type-74LS157 Integrated Circuit	37-74LS157
6B	Type-74LS32 Integrated Circuit	37-74LS32
7A	Type-74LS244 Integrated Circuit	37-74LS244
7B	Type-74LS00 Integrated Circuit	37-74LS00
8B	Type-74LS378 Integrated Circuit	137305-001
9A	Type-74LS00 Integrated Circuit	37-74LS00
9B	Type-74LS00 Integrated Circuit	37-74LS00
10A	Type-74LS00 Integrated Circuit	37-74LS00
10B	Type-74LS00 Integrated Circuit	37-74LS00
11A	Type-74LS378 Integrated Circuit	137305-001
12A	Type-74LS240 Integrated Circuit	137251-001
12B	Type-74LS04 Integrated Circuit	37-74LS04
16C	Type-74C04 Integrated Circuit	137309-001
17C	Type-74LS161 Integrated Circuit	37-74LS161
Resistors		
R1-11	4.7 k Ω , $\pm 5\%$, 1/4 W Resistor	110000-472
R12	10 k Ω , $\pm 5\%$, 1/4 W Resistor	110000-103
R13	10 k Ω , $\pm 5\%$, 1/4 W Resistor	110000-103
R14	3.3 k Ω , $\pm 5\%$, 1/4 W Resistor	110000-332
R15	1 k Ω , $\pm 5\%$, 1/4 W Resistor	110000-102
R16	3.3 k Ω , $\pm 5\%$, 1/4 W Resistor	110000-332
R17	10 k Ω , $\pm 5\%$, 1/4 W Resistor	110000-103
R18	3.3 k Ω , $\pm 5\%$, 1/4 W Resistor	110000-332
R19	1 k Ω , $\pm 5\%$, 1/4 W Resistor	110000-102
R20	43 k Ω , $\pm 5\%$, 1/4 W Resistor	110000-433
R21	27 k Ω , $\pm 5\%$, 1/4 W Resistor	110000-273
R22	1.8 k Ω , $\pm 5\%$, 1/4 W Resistor	110000-182
R23-26	43 k Ω , $\pm 5\%$, 1/4 W Resistor	110000-433
R27	220 Ω , $\pm 5\%$, 1/4 W Resistor	110000-221
R28	330 Ω , $\pm 5\%$, 1/4 W Resistor	110000-331
RN1-6	8 \times 4.7k, Single-Inline Package Resistor	118002-472
RN7-8	10k \times 8, Single-Inline Package Resistor	118002-103
Sockets		
1D-18D	28-Contact, Medium-Insertion-Force IC Socket	79-42C28
1E-18E	28-Contact, Medium-Insertion-Force IC Socket	79-42C28
6A	20-Contact, Medium Insertion Force IC Socket	79-42C20
8A	20-Contact, Medium-Insertion-Force IC Socket	79-42C20
15A	20-Contact, Medium-Insertion-Force IC Socket	79-42C20
16A-18A	28-Contact, Medium-Insertion-Force IC Socket	79-42C28
17B	40-Contact, Medium-Insertion-Force IC Socket	79-42C40
Transistor		
Q2	Type-2N3904 Transistor	34-2N3904
Q3-4	Type-2N3906 Transistor	33-2N3906

(continued on next page)

Cartridge Printed-Circuit Board Assembly Parts List, continued

Designator	Description	Part No.
Miscellaneous		
OPI-3	2-Position Connector Receptacle	179178-002
OPI-3	6-Position Header Connector	179177-006
Q1B	Type-79L05 Voltage Regulator (Acceptable substitute is part no. 37-7905)	37-79L05
	8.20-Inch Bus Bar	178179-008
	TTL Cartridge Board	043027-01
	Test Point (Acceptable substitute is part no. 020670-01)	179051-002

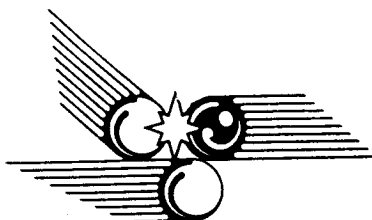

Glossary

AC

Alternating current; from zero it rises to a maximum positive level, then passes through zero again to a maximum negative level.

ACTIVE STATE

The true state of a signal. For example: The active state for START is low.

ADDRESS

A value that identifies a specific location of data in memory; normally expressed in hexadecimal notation.

ANALOG

Measurable in an absolute quantity (as opposed to on or off). Analog devices are volume controls, light dimmers, stereo amplifiers, etc.

ANODE

The positive (arrow) end of a diode.

AMPLIFIER

A device used to increase the strength of an applied signal.

AMPLITUDE

The maximum instantaneous value of a waveform pulse from zero.

ASTABLE

Having no normal state. An astable device will free-run or oscillate as long as operating voltage is applied. The oscillation frequency is usually controlled by external circuitry.

AUXILIARY COIN SWITCH

A momentary-contact pushbutton switch with a black cap located on the utility panel. The auxiliary coin switch adds credits to the game without activating a coin counter.

BEZEL

A cut, formed, or machined retention device, such as the conical device used to mount a pushbutton switch to a control panel, or the formed device used to frame the video display screen.

BIDIRECTIONAL

Able to send or receive data on the same line (e.g., the data bus of a microprocessor).

BINARY

A number system that expresses all values by using two digits (0 and 1).

BIT

A binary digit; expressed as 1 or 0.

BLANKING

Turning off the beam on a cathode-ray tube during retrace.

BLOCK DIAGRAM

A drawing in which functional circuitry units are represented by blocks. Very useful during initial troubleshooting.

BUFFER

1. An isolating circuit designed to eliminate the reaction of a driven circuit on the circuits driving it (e.g., a buffer amplifier).

2. A device used to supply additional drive capability.

BUS

An electrical path over which information is transferred from any of several sources to any of several destinations.

CAPACITOR

A device capable of storing electrical energy. A capacitor blocks the flow of DC current while allowing AC current to pass.

CATHODE

The negative end of a diode.

CHIP

An integrated circuit comprising many circuits on a single wafer slice.

CLOCK

A repetitive timing signal for synchronizing system functions.

COINCIDENCE

Occurring at the same time.

COIN COUNTER

A 6-digit electromechanical device that counts the coins inserted in the coin mechanism(s).

COIN MECHANISM

A device on the inside of the coin door that inspects the coin to determine if the correct coin has been inserted.

COMPLEMENTARY

Having opposite states, such as the outputs of a flip-flop.

COMPOSITE SYNC

Horizontal and vertical synchronization pulses that are bused together into a single signal. This signal provides the timing necessary to keep the display in synchronization with the game circuitry.

COMPOSITE VIDEO

Complete video signal from the game system to drive the display circuitry; usually comprising H SYNC, V SYNC, and the video.

CREDIT

One play for one person based on the game switch settings.

CRT

Cathode-ray tube.

DATA

General term for the numbers, letters, and symbols that serve as input for device processing.

DARLINGTON

A two-transistor amplifier that provides extremely high gain.

DC

Direct current, meaning current flowing in one direction and of a fixed value.

DEFLECTION YOKE

Electromagnetic coils around the neck of a cathode-ray tube. One set of coils deflects the electron beam horizontally and the other set deflects the beam vertically.

DIAGNOSTICS

A programmed routine for checking circuitry. For example: the self-test is a diagnostic routine.

DIODE

A semiconductor device that conducts in only one direction.

DISCRETE

Non-integrated components, such as resistors, capacitors, and transistors.

DMA

Direct memory access. DMA is a process of accessing memory that bypasses the microprocessor logic. DMA is normally used for transferring data between the input/output ports and memory.

DOWN TIME

The period during which a game is malfunctioning or not operating correctly due to machine failure.

EAROM

Electrically alterable read-only memory (see ROM). The EAROM is a memory that can be changed by the application of high voltage.

FLYBACK

A step-up transformer used in a display to provide the high voltage.

GATE

1. A circuit with one output that responds only when a certain combination of pulses is present at the inputs.

2. A circuit in which one signal switches another signal on and off.

3. To control the passage of a pulse or signal.

HARNESS

A prefabricated assembly of insulated wires and terminals ready to be attached to a piece of equipment.

HEXADECIMAL

A number system using the equivalent of the decimal number 16 as a base. The symbols 0–9 and A–F are usually used.

IMPLODE

To burst inward; the inward collapse of a vacuum tube.

I/O

Input/Output.

IRQ

Interrupt request. IRQ is a control signal to the microprocessor that is generated by external logic. This signal tells the microprocessor that external logic needs attention. Depending on the program, the processor may or may not respond.

LED

The abbreviation for a light-emitting diode.

LOCKOUT COIL

Directs coins into the coin return box when there is no power to the game.

LOGIC STATE

The binary (1 or 0) value at the node of a logic element or integrated circuit during a particular time. Also called the logic level. The list below shows the voltage levels corresponding to the logic states (levels) in a TTL system.

Logic 0, Low = 0 VDC to +0.8 VDC

Grey Area (Tri-State Level) =

+0.8 VDC to +2.4 VDC

Logic 1, High = +2.4 VDC to +5 VDC

MULTIPLEXER

A device that takes several low-speed inputs and combines them into one high-speed data stream for simultaneous transmission on a single line.

NMI

Non-maskable interrupt. NMI is a request for service by the microprocessor from external logic. The microprocessor cannot ignore this interrupt request.

PAGE

A subsection of memory. A read-only memory device (see ROM) is broken into discrete blocks of data. These blocks are called pages. Each block has X number of bytes.

PCB

The abbreviation for a printed-circuit board.

PHOTOTRANSISTOR

A transistor that is activated by an external light source.

POTENTIOMETER

1. A resistor that has a continuously moving contact which is generally mounted on a moving shaft. Used chiefly as a voltage divider. Also called a *pot* (slang).

2. An instrument for measuring a voltage by balancing it against a known voltage.

RAM

Random-access memory. A device for the temporary storage of data.

RASTER-SCAN DISPLAY

A display system whereby images are displayed by continuously scanning the cathode-ray tube horizontally and vertically with an electron beam. The display system controls the intensity of the electron beam.

RETRACE

In a raster-scan display, retrace is the time during which the cathode-ray tube electron beam is resetting either from right to left or from bottom to top.

RESISTOR

A device designed to have a definite amount of resistance. Used in circuits to limit current flow or to provide a voltage drop.

ROM

Read-only memory. A device for the permanent storage of data.

SIGNATURE ANALYSIS

A process of isolating digital logic faults at the component level by means of special test equipment called signature analyzers. Basically, signature analyzers (e.g., the ATARI® CAT Box) convert lengthy bit streams into four-digit hexadecimal signatures. The signature read by the analyzer at each circuit node is then compared with the known good signature for that node. This process continues until a fault is located.

TROUBLESHOOT

The process of locating and repairing a fault.

VECTOR

A line segment drawn between specific X and Y coordinates on a cathode-ray tube.

WATCHDOG

A counter circuit designed to protect the microprocessor from self-destruction if a program malfunction occurs. If a malfunction does occur, the counter applies continuous pulses to the reset line of the microprocessor, which causes the microprocessor to keep resetting.

X-Y DISPLAY

A display system whereby images are displayed with vectors.

ZENER DIODE

A special diode used as a regulator. Its main characteristic is breaking down at a specified reverse-bias (Zener) voltage.