

This document has been downloaded from:



The largest resource for amusement machines
documentation on the world wide web!



FLIPPERSPILL.COM

NAOMI™



MARVEL: TM & © 2000 MARVEL CHARACTERS, INC. ALL RIGHTS RESERVED.
©CAPCOM CO., LTD. 2000, ©CAPCOM U.S.A., INC. 2000 ALL RIGHTS RESERVED.
STRIDER: ©MOTO KIKAKU. ©CAPCOM CO., LTD. 2000,
©CAPCOM U.S.A., INC. 2000 ALL RIGHTS RESERVED.

This video game has been produced under the license from Marvel Characters, Inc.

OPERATORS MANUAL

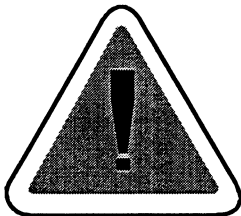

WARNING

This game is for use in the United States of America and Canada. Sales, export or operation outside of these countries may be constructed as copyright and trademark infringements and is strictly prohibited. Violators are subject to severe penalties and will be prosecuted to the full extent of the law.

CAPCOM®

MVCT1300
031300
000224 USA

THANK YOU FOR PURCHASING *MARVEL VS. CAPCOM 2™*. WE INVITE YOU TO USE THE FOLLOWING MAILING ADDRESS, TELEPHONE OR FAX NUMBER FOR PARTS OR SERVICE INFORMATION CONCERNING THIS GAME:

CAPCOM® COIN-OP, INC.
ATTN: CUSTOMER SERVICE
475 OAKMEAD PARKWAY
SUNNYVALE, CA 94086
PHONE: (408) 522-5327
FAX: (408) 522-5331

THE SERIAL NUMBERS OF YOUR GAME ARE LOCATED ON THE PRINTED CIRCUIT BOARDS AS SHOWN BELOW. PLEASE HAVE THESE SERIAL NUMBERS AVAILABLE WHEN CONTACTING US FOR SERVICE INFORMATION.

AAMA SERIAL NUMBER

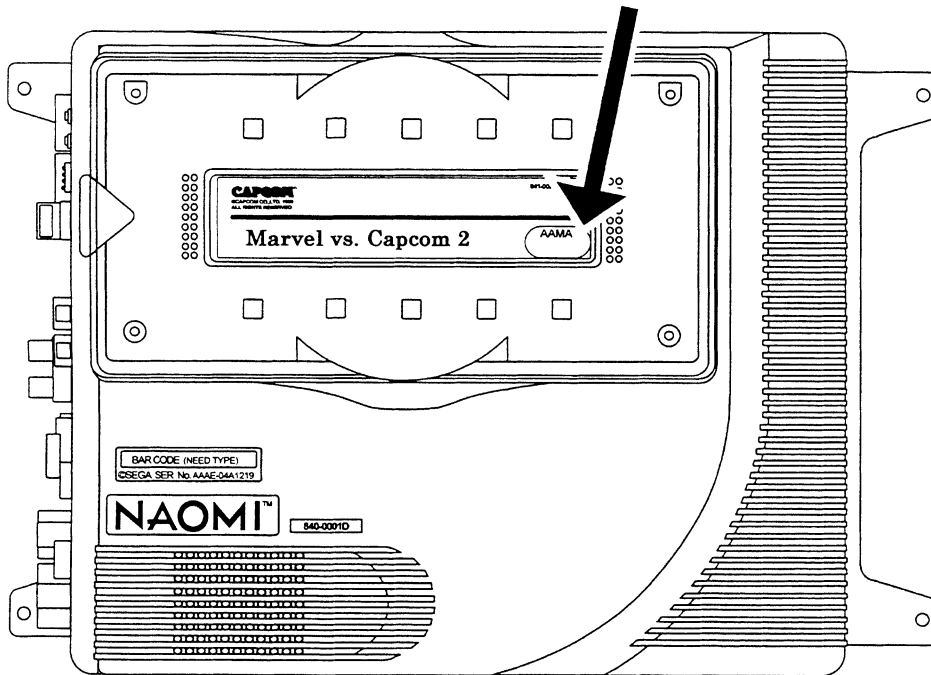

PLEASE RECORD THE AAMA SERIAL NUMBER HERE:

1) AAMA SERIAL NUMBER: _____

PLEASE APPLY PRODUCT SERIAL NUMBER STICKER HERE:

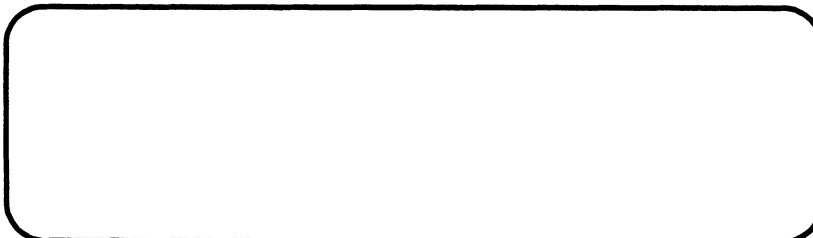

TABLE OF CONTENTS

Warranty Information	ii
Safety Notices	iii
Kit Inspection	
Kit Parts List	1
PCB & Cables information	2
PCB Handling information	2
Kit Installation	
Preparation	3
Installation	3
Marquee	3
Control Panel Overlay	3
Cabinet Decals	3
Control Panel Components	4
Test Switch/Service Switch	4, 13
PC Boards	5
Wiring	
Control Panel	4, 13
Test Switch/Service Switch	4, 13
PC Boards	6, 13
Game Adjustments	
NAOMI SYSTEM Test Mode	7
Cautions on NAOMI SYSTEM Test Menu	8
Game Test Mode	9
Accessing the Menu	9
How to Select an Item	9
Menu Item Descriptions	9
Selecting monitor type (31K or 15K)	10
NAOMI Converter setting (6 Button 2 Players/ 4 Button 4 Players)	10
Game Configuration	11
Game Configuration option	12
Sound Mode	12
Reference Information	
Table 1: JAMMA Connections	17
Table 2: Test Switch/Service Switch wiring chart	17
Table 3: Auxiliary Cable (P/N 03-0105) connections	17
PCB Connector and Control location	Inside of back cover
Control Panel sample layout	Inside of back cover

LIMITED PRODUCT WARRANTY (APPLIES TO DOMESTIC SALES ONLY)

CAPCOM® COIN-OP, INC. (Seller), warrants only to the initial purchaser of its products, that the items listed below are free from defects in material and workmanship under normal use and service for the warranty periods specified:

- | | |
|--|------------------|
| A. Printed Circuit Boards: | Ninety (90) Days |
| B. Electronic and Mechanical Components: | Ninety (90) Days |

No other part of Seller's products are warranted.

Warranty periods are effective from the initial date of shipment from seller to its authorized distributors.

Seller's sole liability shall be, at its option, to repair or replace products which are returned to Seller during the warranty periods specified, provided:

- A. Seller is notified promptly upon discovery by buyer that stated products are defective;
- B. Such products are properly packaged and then returned, prepaid to Seller's designated plant.

This warranty does not apply to any parts damaged during shipment or handling, or due to improper installation, usage or alteration. In no event shall Seller be liable for any anticipated profits, loss of profits, loss of use, incidental or consequential damages or any other losses incurred by the customer in connection with the purchase of a CAPCOM® COIN-OP, INC. product.

WARRANTY DISCLAIMER

EXCEPT AS SPECIFICALLY PROVIDED IN A WRITTEN CONTRACT BETWEEN SELLER AND PURCHASER, THERE ARE NO OTHER WARRANTIES, EXPRESSED OR IMPLIED, INCLUDING ANY IMPLIED WARRANTIES OF MERCHANTABILITY OR FITNESS FOR A PARTICULAR PURPOSE.

IMPORTANT NOTICE

THIS SHIPMENT HAS BEEN CAREFULLY INSPECTED AND PROPERLY PACKAGED BEFORE LEAVING THE FACTORY. WE CANNOT ASSUME RESPONSIBILITY FOR BREAKAGE THAT MAY OCCUR DURING TRANSPORTATION OF THE GAME. IF THIS GAME IS DAMAGED UPON RECEIPT FROM THE CARRIER, IMMEDIATELY NOTIFY THE CARRIER AND FILE A DAMAGE REPORT.

SAFETY NOTICES

The following safety instructions apply to all game operators and service personnel. There are specific warnings and cautions throughout this manual where they apply. Read this page before preparing your game for play.

CAUTION

For your safety, please read and abide by the following instructions when handling the P.C. board.

- Make sure the power is off before installing the board or changing the settings of the board.
- Do not damage the wiring cables.
- Do not disassemble the case.
- Do not touch the board, connectors or the harness with wet hands.

Please keep the following instructions to keep the P.C. board in good condition.

- Do not block the ventilation slots.
- Do not keep the board in extremely cold/hot places.
- Do not drop or bump the board.
- Do not spill any liquids on the case.
- Do not disassemble the case.
- Always keep the connectors clean.
- Do not disconnect the connectors, cables, or the harness while the power is on.

WARNING

Plug the game into a properly grounded outlet to prevent shock hazards and assure proper game operation. Do not use a cheater plug to defeat the power cord's grounding pin. Do not cut off the ground pin.

EPILEPSY WARNING

A very small portion of the population has a condition which may cause them to experience epileptic seizures or have momentary loss of consciousness when viewing certain kinds of flashing lights or patterns that are present in our daily environment. These persons may experience seizures while watching some kinds of television pictures or playing certain video games. People who have not had any previous seizures may nonetheless have an undetected epileptic condition.

If you or anyone in your family has experienced symptoms linked to an epileptic condition (e.g., seizures or loss of awareness), immediately consult your physician before using any video games.

Parents should observe their children while they play video games. If you or your child experience the following symptoms: dizziness, altered vision, eye or muscle twitching, involuntary movements, loss of awareness, disorientation, or convulsions, DISCONTINUE USE IMMEDIATELY and consult your physician.

KIT INSPECTION

CHECK THAT ALL OF THE FOLLOWING PARTS HAVE BEEN SHIPPED WITH YOUR KIT.
IF ANY PARTS ARE MISSING, CONTACT YOUR DISTRIBUTOR IMMEDIATELY.

MVCT1000 "MARVEL VS. CAPCOM 2 FULL KIT" PARTS LIST

PART NO.	DESCRIPTION	QTY
MVCT1400	MARVEL VS. CAPCOM 2 COMPLETE PCB	1
NAOMI-CONVERTER	JVS TO JAMMA CONVERTER FOR NAOMI SYSTEM	1
CBL-VGA	CABLE ASSY, D-SUB 15PIN, VGA/SVGA CABLE	1
CBL-USB	CABLE ASSY, USB CABLE	1
CBL-AUDIO-ST	CABLE ASSY, STEREO AUDIO CABLE	1
CBL-POWER-NAOMI	CABLE ASSY, POWER CABLE 8PIN FOR NAOMI	1
MVCT1110	MARQUEE, "MARVEL VS. CAPCOM 2"	1
MVCT1300	OPERATORS MANUAL, "MARVEL VS. CAPCOM 2"	1
NOM1300	SEGA NAOMI SERVICE MANUAL	1
AW00245-2	BUTTON/ JOYSTICK LABEL, GENERIC	1
MVCT2520-01	GAME PLAY INSTRUCTION - TOP "MARVEL VS. CAPCOM 2"	1
MVCT2520-02	GAME PLAY INSTRUCTION - BOTTOM "MARVEL VS. CAPCOM 2"	1
GE1200	MONITOR CARD	1
AW00147	DECAL, CABINET SIDE	2
AW00216	CONTROL PANEL OVERLAY	1
PL00376	MARQUEE PLEX, CLEAR, 27.0 X 9.0 X 1/8"	1
GE2030	JOYSTICK, 8 WAY	2
16-0130	SWITCH, 1-PLAYER START BUTTON (WHITE)	1
16-0131	SWITCH, 2-PLAYER START BUTTON (WHITE)	1
16-0133	SWITCH, BUTTON (RED)	4
16-0134	SWITCH, BUTTON (BLUE)	4
16-0136	SWITCH, BUTTON (GREEN)	4

Note: Because of availability, your kit may contain different color of push buttons.

PCB & Cables

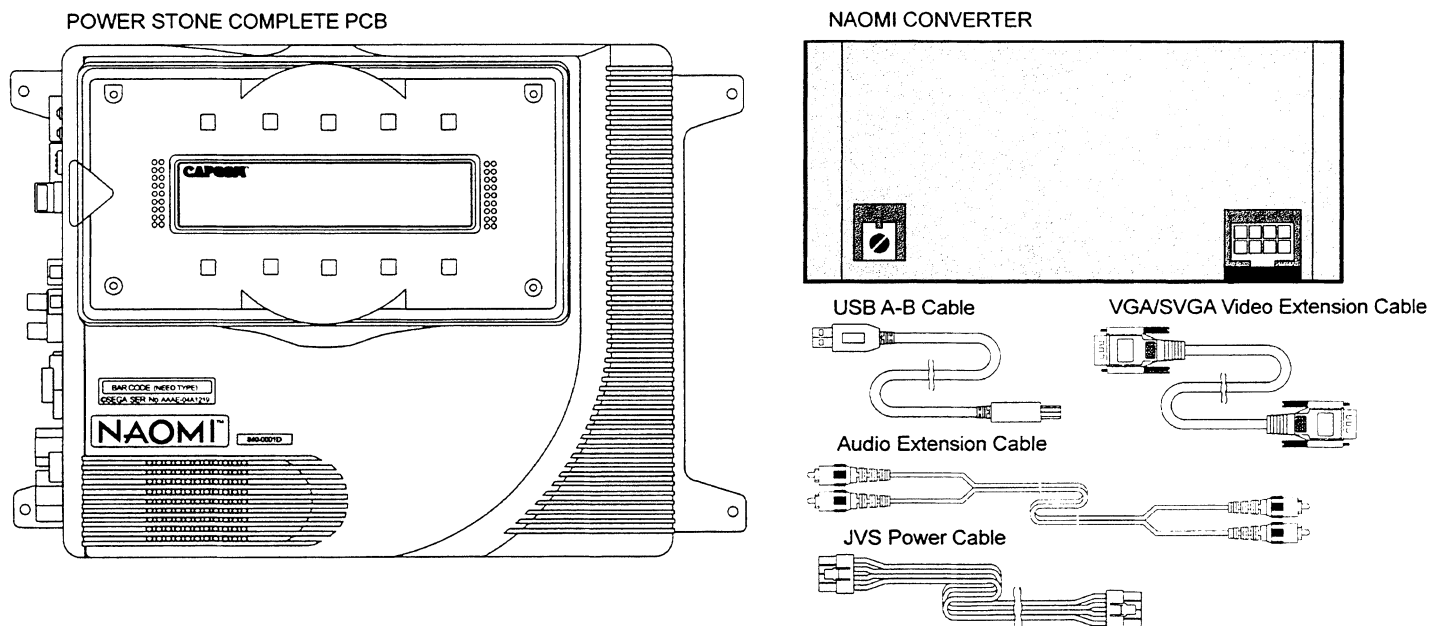

Note 1: Please make sure your power supply supports 7A or more.

Note 2: Please make sure your power supply voltage is at $+5V \pm 5\%$.

CAUTION

For your safety, please read and abide by the following instructions when handling the P.C. board.

- Make sure the power is off before installing the board or changing the settings of the board.
- Do not damage the wiring cables.
- Do not disassemble the case.
- Do not touch the board, connectors or the harness with wet hands.

Please keep the following instructions to keep the P.C. board in good condition.

- Do not block the ventilation slots.
- Do not keep the board in extremely cold/hot places.
- Do not drop or bump the board.
- Do not spill any liquids on the case.
- Do not disassemble the case.
- Always keep the connectors clean.
- Do not disconnect the connectors, cables, or the harness while the power is on.

WARNING

Plug the game into a properly grounded outlet to prevent shock hazards and assure proper game operation. Do not use a cheater plug to defeat the power cord's grounding pin. Do not cut off the ground pin.

KIT INSTALLATION



WARNING:

MAKE SURE ELECTRICAL POWER TO THE GAME IS OFF BEFORE STARTING THE KIT INSTALLATION.

PREPARATION

1. Disconnect and remove the old printed circuit board(s) from the cabinet.
2. Remove or open the control panel, and disconnect and remove the buttons and joystick(s) from the control panel.
3. Remove any covering from the control panel overlay, and then remove the control panel overlay.
4. Determine where any new holes should go. Center punch any needed new holes on the control panel.
5. Cut out the new holes using a 1-3/16" hole saw.
6. If there is an additional Control Panel Cover, figure 1 (such as plastic or lexan) that will be utilized cut any additional holes using the same template.
*Cover is not included in the kit.
7. Plug up unused holes with a wood dowel (1-1/8" diameter) and sand any rough edges.

INSTALLATION

MARQUEE INSTALLATION

8. Remove the marquee plexi glass, marquee overlay, and the cabinet graphics.
9. Install the new marquee and replace the plexi glass. Clear plexi glass is included in "full" kit.

CONTROL PANEL OVERLAY INSTALLATION (See Figure 1)

10. The control panel overlay in the kit is oversized to accommodate most control panel sizes. Center the overlay on the control panel, leaving some excess material at the edges.
11. Remove the protective backing from the overlay and press it down on the control panel, keeping it properly aligned. Press it down firmly, smooth out any bubbles, and press it over the edges.
12. Trim any excess from the overlay. Place the drill hole template on top of the overlay, aligning it with the joystick holes. Pierce through the overlay at each control panel hole. Then, cut away overlay material covering the joystick and button holes. Remove the template and clean off the overlay.

13. Peel off the backings of the 6-button and joystick decals, align over the control panel holes, and press in place on the overlay (refer to the drill hole template for proper placement). Using a knife, trim material from the center hole of the joystick decal.

14. Install the control panel cover, figure 1. (If required).

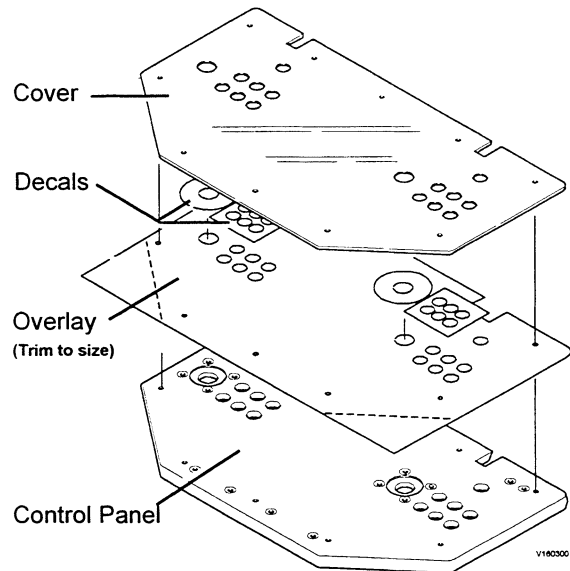

Figure 1: Overlay Installation

CABINET DECAL INSTALLATION

15. Remove monitor glass and install monitor card
16. Peel-off the backing to the instruction decals and place on both the top and bottom of the monitor card. (See Figure 2). Also, apply the cabinet decals to both sides of the cabinet.

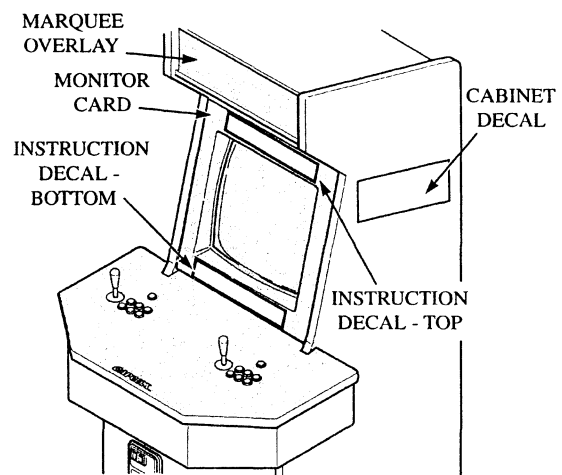

Figure 2: Cabinet Decal Installation

RE-ASSEMBLY OF COMPONENTS

- Notice that there are two white buttons. See figure 3. The WHITE buttons are START buttons. Install the one player button on the top left-hand side of the control panel, and the two players button on the top right-side of the control panel.

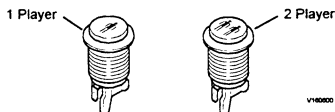

Figure 3: Start Buttons

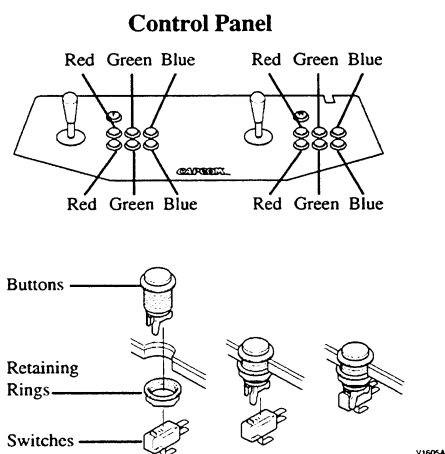

Figure 4: Control Panel Buttons and Switches

- Install all buttons and retaining rings on the control panel as shown in Figure 4. Install two red buttons to the immediate right of each joystick, install two green buttons to the right of the red ones, and install two blue buttons to the right of the green ones.
- Install the switches on the buttons as shown in figure 4. Orient the switches so that when a button is pressed, the plastic contact on the switch is depressed.
- Install the joysticks on the control panel as shown in figure 5.

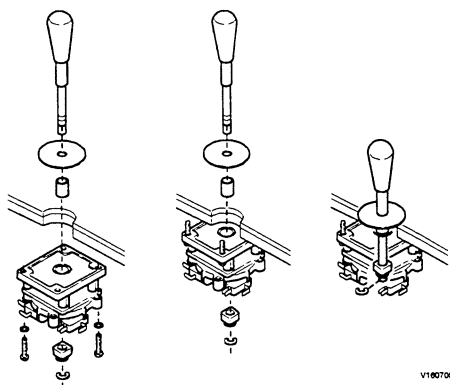

Figure 5: Joystick Installation

CONTROL PANEL WIRING

NOTE: All switch wires used in this game must be wired to the N.O. (Normally-Open) connection on the switches. Each switch requires a ground wire on the COM. (Common) connector and the appropriate control or switch wire on the N.O. (Normally-Open) connector of the switch.

- Reconnect the existing JAMMA connectors to the control panel according to the chart in table 1 on page 17.
- Connect the player 1 and the player 2 kick buttons to the auxiliary cable harness as shown in figure 6. Make the connections according to the chart in table 2.

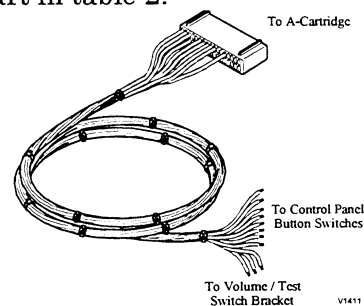

Figure 6: Auxiliary Cable Harness

TEST SWITCH WIRING

- Your cabinet may already equipped with test switch and service switch. When installing, the test switch and service switch, should be mounted inside the coin door and on top of the cash box for easy access. (See Table 3: for wiring detail)

NOTE: Test switch and service switch should be installed for this game to access NAOMI test menu system.

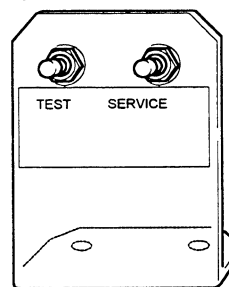

Figure 7: Test/Service switch mounting

Volume adjustments must be made through the volume control knob located on the NAOMI - CONVERTER PC- board.

- If you are converting a cabinet that is equipped with CAPCOM® Q-SOUND, you may use stereo audio output connect to existing Q-SOUND POWER AMPLIFIER. And set "SOUND MODE" to "Stereo". See "SYSTEM CONFIGURATION" for detail.

PC BOARD INSTALLATION

25. Install the PCB and the NAOMI-CONVERTER to the mounting shelf.

- Wood Screws for NAOMI-CONVERTER are not included in the kit.

PARALLEL MOUNTING

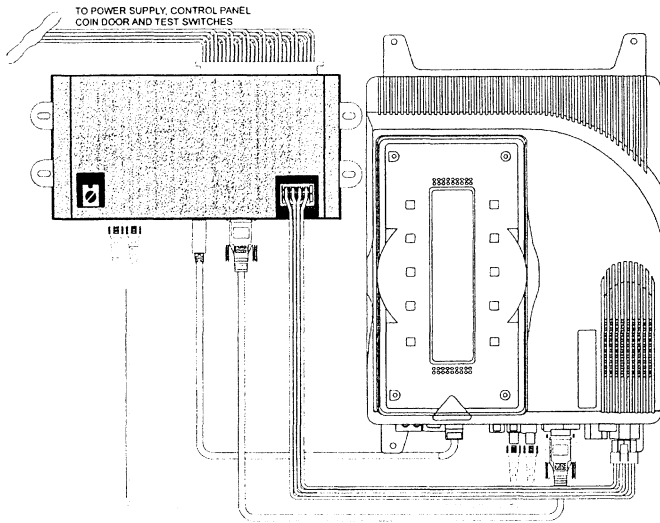

TANDEM MOUNTING

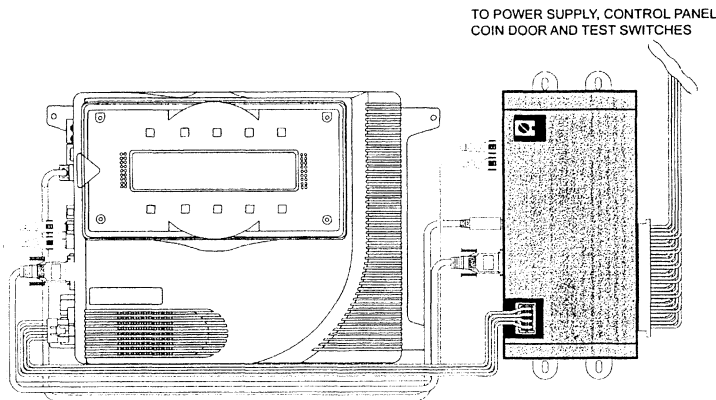

PC BOARD MOUNTING TIPS

- Parallel Mounting

This mounting style is recommended for a regular style cabinet equipped with a horizontal mounting shelf.

- Tandem Mounting.

This mounting style could be used for cabinets which have a vertical mounting shelf.

If you are mounting in tandem make sure you have enough room to access cables, connectors and switches.

- Stacked Mounting.

If your cabinet does not have enough room to mount two PC Boards in parallel or tandem position. This mounting style may be used to install the PC Boards.

Use large mounting brackets supplied in the kit to mount the NAOMI-CONVERTER over the top of the game PC Board.

We recommend mounting PC Boards in the horizontal position for easy access and stable operation.

MOUNTING THE NAOMI CONVERTER

When using the small brackets

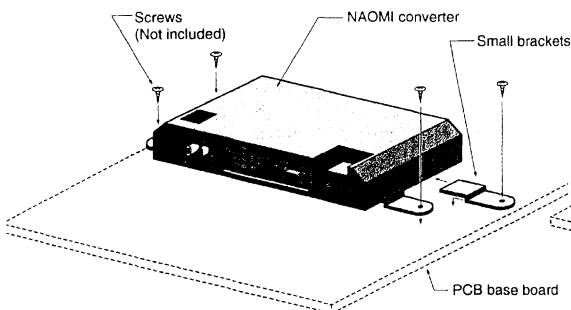

When using the large brackets

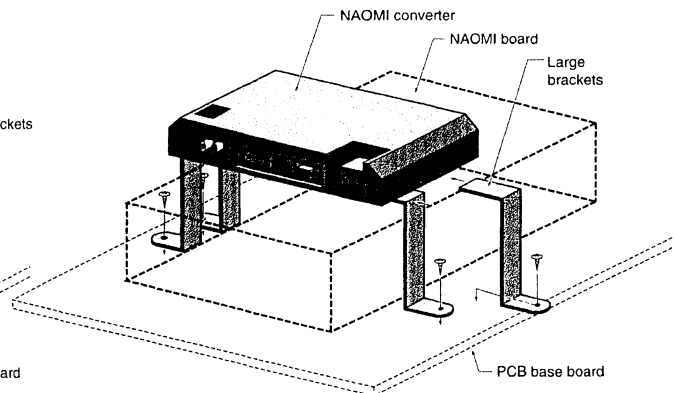

PC BOARD WIRING CONNECTIONS



WARNING

Improper installation of the connector harness (JAMMA / USB/VIDEO) to the PC board connector may cause damage to the PC board.

- 30. Attach Power, USB cable, Audio cable and Video cable to NAOMI Board.
- 31. Connect other end to NAOMI-COVERTER Board.
- 32. If you are installing the game equipped with High-Resolution monitor, connect the Video cable to the monitor.

A standard low-resolution video signal is supplied through the JAMMA connector on the NAOMI-CONVETER, if your cabinet is not equipped with a high-resolution monitor. The NAOMI_CONVERTER Board will not convert video signal frequency and signal level.

- 33. Connect the JAMMA harness connector to the edge connector on the NAOMI-CONVERTER Board.
- 34. If you elect to use Q_Sound Audio Amplifier or similar stereo amplifier board, connect audio cable to audio output on the NAOMI-CONVERTER Board.

Audio volume control is located on the NAOMI_CONVERTER Board.

Sound setting and output terminal (please refer to GAME CONFIGURATION to set the SOUND MODE)

SOUND MODE	OUTPUT TERMINAL	SOUND
STEREO	JAMMA HARNESS ONLY	MONAURAL
	STEREO OUT	STEREO
MONAURAL	JAMMA HARNESS ONLY	MONAURAL
	STEREO OUT	

● CONNECTOR LOCATIONS

• JAMMA CONNECTOR SIDE

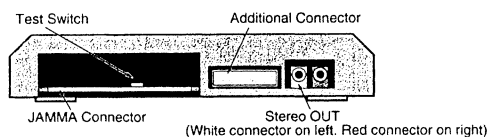

• NAOMI CONNECTOR SIDE

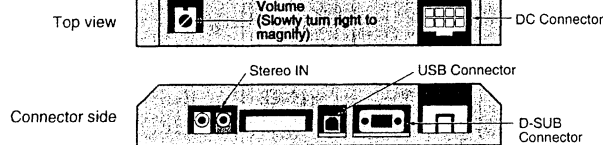

● WIRING DIAGRAM

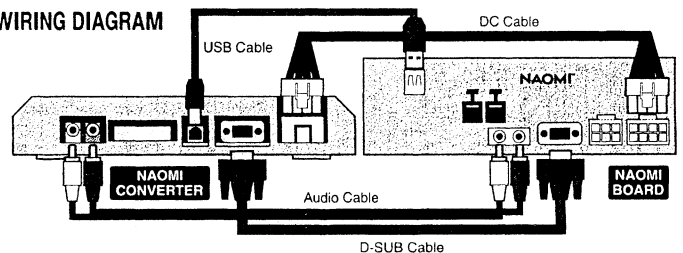

NAOMI SYSTEM TEST MODE

This test mode mainly allows the PC Board to be checked for accurate functioning, monitor color to be adjusted as well as COIN ASSIGNMENT AND GAME ASSIGNMENT to be adjusted.

For the details of "NAOMI SYSTEM MENU", please refer to "NAOMI SERVICE MANUAL".

HOW TO ENTER THE TEST MODE

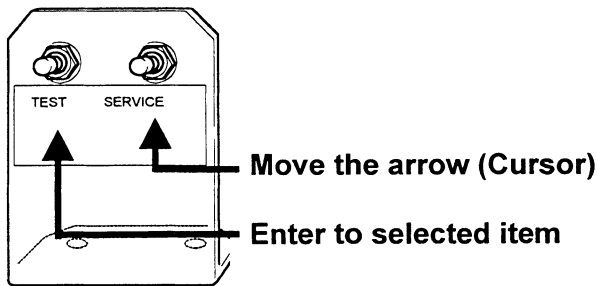

For the details of "NAOMI SYSTEM MENU" please refer to "NAOMI SERVICE MANUAL".

To enter the GAME TEST MODE, move the "—>" cursor to GAME TEST MODE in the NAOMI SYSTEM MENU and press the Test Button.

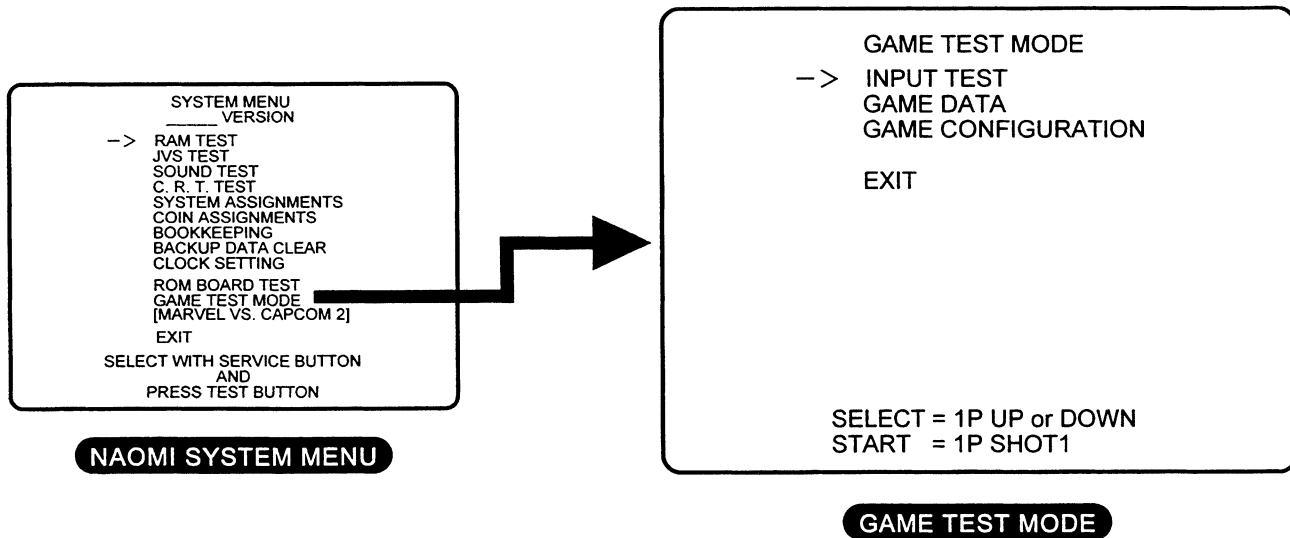

CAUTIONS ON NAOMI SYSTEM MENU

1) Please set the **CABINET TYPE** and the **MONITOR TYPE** of the **SYSTEM ASSIGNMENTS** menu to "2 PLAYER(S)" and "HORIZONTAL" respectively.

This game will not function properly if above is not followed.

2) The following is the default settings of **COIN ASSIGNMENTS**.

COIN CHUTE TYPE	COMMON
COIN/CREDIT SETTING	#12
COIN CHUTE #1	2 COINS 1 CREDIT
COIN CHUTE #2	2 COINS 1 CREDIT

3) Please refer to the following for the **SEQUENCE SETTING** of the **COIN ASSIGNMENTS**.

SEQUENCE 1: Credits required to start the game.

SEQUENCE 2: Credits required to continue the game.

* SEQUENCE 3~8 is not available in MARVEL VS. CAPCOM 2.

* **Ex) Standard setting**

One(1) credit to start and continue the game.

SEQUENCE 1	1 CREDIT(S)	← Credits required to start the game.
SEQUENCE 2	1 CREDIT(S)	← Credits required to continue the game.

* **Ex) 2 credits start, 1 credit continue setting**

Players need 2 credits to start the game but only one credit to continue the game.

SEQUENCE 1	2 CREDIT(S)	← Credits required to start the game.
SEQUENCE 2	1 CREDIT(S)	← Credits required to continue the game.

4) **BOOKKEEPING 2/2** indicates the following:

P1(P2) SEQ 1: The number of times the game was started from Player 1 and Player 2 each.

P1(P2) SEQ 2: The number of times the game was continued from Player 1 and Player 2 each.

* SEQ 3~8 is not available in "MARVEL VS. CAPCOM 2".

Ex) The number of "Start" of 1P side.

The number of "Start" of 2P side.

P1	SEQ 1	82	P2	SEQ 1	45
P1	SEQ 2	36	P2	SEQ 2	15

The number of "Continue" of 1P side.

The number of "Continue" of 2P side.

GAME TEST MODE

The test menu allows you to test input devices such as joysticks, buttons and coin mechs
 Through the test menu you can also access the game configuration menu, where you can change the settings of the game.
 The game data shows the earning-related data.

Your setting will be saved in the backup RAM. Do not turn off the power before you EXIT game test mode!

The NAOMI SYATEM MENU will appear when you EXIT GAME TEST MODE

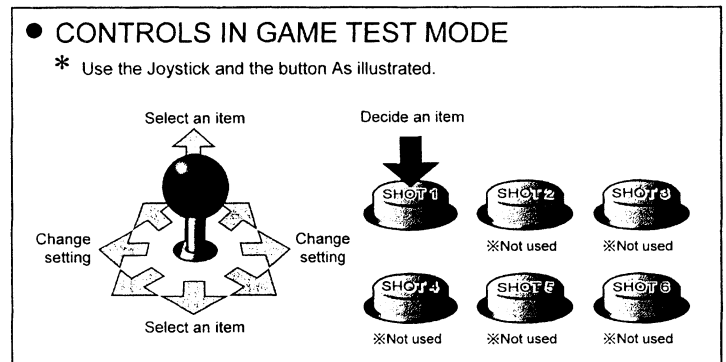
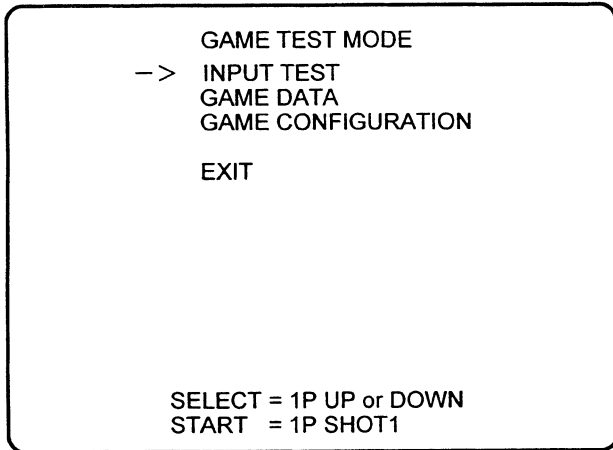

GAME TEST MODE

4. TEST MENU ITEM DESCRIPTIONS

<p>INPUT</p>	<p>TESTS THE "INPUT SIGNAL" OF THE LEVER AND THE BUTTONS. WHEN THE "INPUT SIGNAL" IS DETECTED, THE NUMBER CHANGES FROM "0" TO "1".</p> <ul style="list-style-type: none"> INSIDE INPUT TEST, YOU CAN TEST UP TO TWO SERVICE BUTTONS. IN CASE YOUR CABINET HAS ONLY ONE SERVICE BUTTON, PLEASE MAKE SURE IF THE 1P SERVICE BUTTON FUNCTIONS PROPERLY. <p>(PLEASE NOTE HOWEVER, ON CERTAIN CABINETS, IT IS POSSIBLE THE NUMBER CHANGES TO "1" ON BOTH 1P AND 2P SIDE.)</p>
<p>GAME DATA</p>	<p>SHOWS THE EARNING-RELATED DATA. PLEASE USE THE INFO TO DETERMINE THE BEST COIN SETTINGS FOR YOUR LOCATION.</p>
<p>CONFIGURATION</p>	<p>SETS THE GAME PLAY SETTINGS SUCH AS DIFFICULTY, NUMBER OF ROUNDS, TIMER, ETC.</p>
<p>EXIT</p>	<p>RETURNS TO NAOMI SYSTEM MENU</p>

• **31K MONITOR CABINET**

The NAOMI board is capable of producing a screen resolution that is three times as high as the CP-SYSTEM II board.

To achieve the maximum performance, it is essential to install the board in a cabinet equipped with a 31K monitor that is capable of high resolution graphics. (Ex. "BLAST CITY" "MEGALO 410" etc. from Sega)

To enjoy NAOMI's graphics at their best, please use the cabinet with 31K monitor.

• **EITHER 15K OR 31K HORIZONTAL MONITOR CAN BE USED.**

To change the frequency setting, set the DIP Switch as shown below.

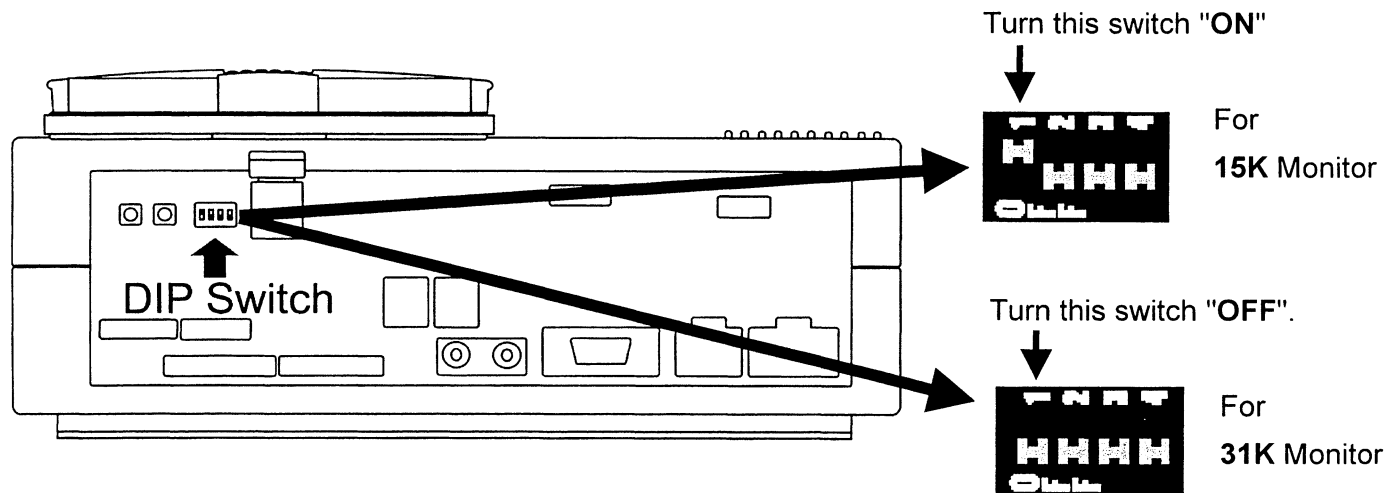

Naomi converter slide switch setting for "MARVEL VS.CAPCOM 2"

Please confirm that the switches are set in proper position as shown below.

1. "C SYNC/H/V SYNC" switch is on right position.
2. "4P 4SHOT / 2P 6SHOT" switch is on right position.

[View from JAMMA connector side]

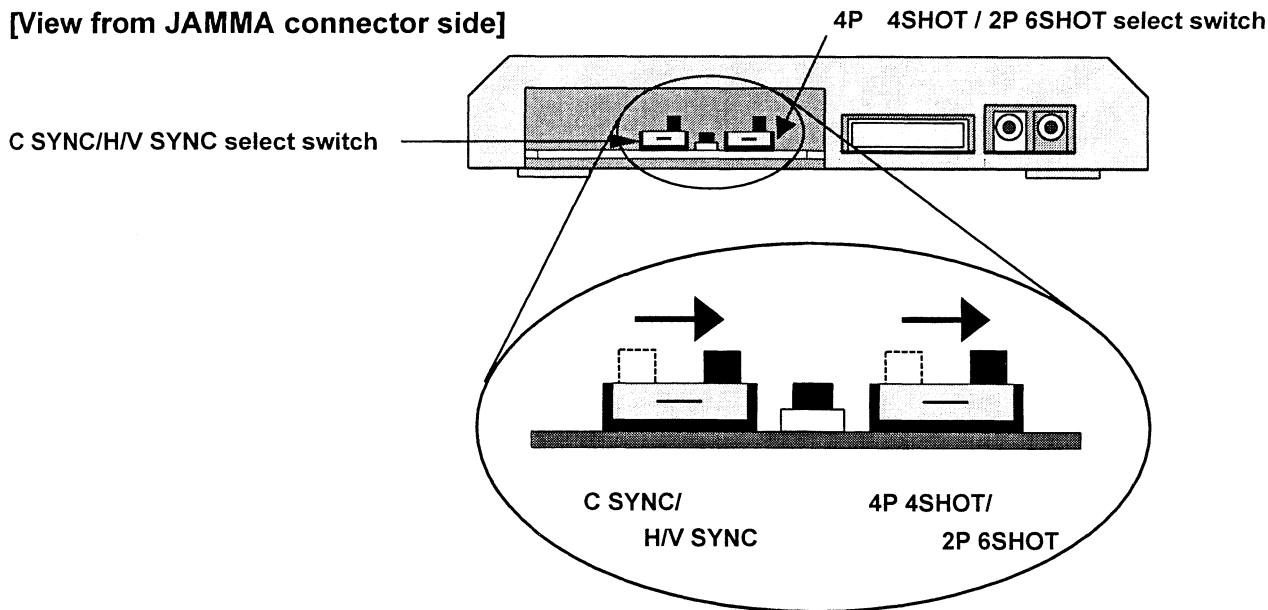

GAME CONFIGURATION

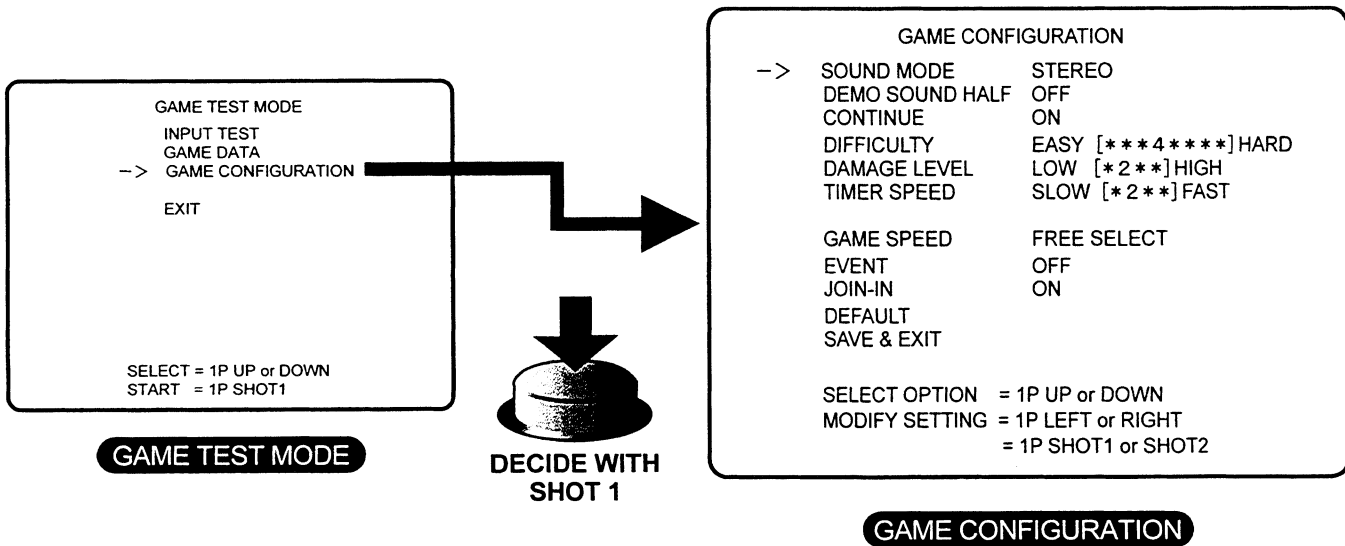

GAME CONFIGURATION ITEM DESCRIPTIONS

SOUND MODE	PLEASE SET THIS ITEM TO STEREO FOR NORMAL OPERATIONS. SETTING TO "MONAURAL" WILL MAKE YOUR SOUND OUTPUT MONAURAL. (WHEN USING NAOMI CONVERTER KIT, PLEASE REFER TO PAGE 3.)
DEMO SOUND HALF	IF SET TO "ON", THE ATTRACT MODE DEMO SOUND PLAYS AT HALF VOLUME. (TO ENABLE THIS SETTING, "ADVERTISE SOUND" MUST SET "ON". PLEASE REFER TO "NAOMI SYSTEM MENU" FOR DETAIL.)
CONTINUE	TURNS ON AND OFF THE CONTINUE FEATURE.
DIFFICULTY	SETS THE GAME'S DIFFICULTY LEVEL. THERE ARE 8 LEVELS IN TOTAL. AS THE NUMBER INCREASES, THE GAME GETS MORE DIFFICULT.
DAMAGE LEVEL	SETS THE ATTACK POWER. THERE ARE 4 LEVELS IN TOTAL. AS THE NUMBER INCREASES, THE ATTACK POWER INCREASES. (THUS THE AVERAGE PLAY TIME GETS SHORTER.)
TIMER SPEED	SETS THE TIMER SPEED. THERE ARE 4 LEVELS IN TOTAL. AS THE NUMBER INCREASES, THE TIME ELAPSES QUICKER.
GAME SPEED	SETS THE GAME SPEED. THE FOLLOWING ARE AVAILABLE: "NORMAL": REGULAR SETTING. "TURBO": QUICKER GAME PLAY. "FREE SELECT": ALLOWS THE PLAYER TO SELECT "NORMAL" OR "TURBO".
EVENT	USE THIS FUNCTION FOR EVENTS/TOURNAMENTS. IF SET TO ON, ONLY 1 CREDIT IS REQUIRED FOR 2 PLAYERS "VS." GAME. HOWEVER, THE GAME WILL BE OVER FOR BOTH PLAYERS REGARDLESS OF THE GAME RESULT. PLEASE SET THIS TO OFF FOR STANDARD OPERATIONS.
JOIN-IN	USED TO TURN ON AND OFF THE JOIN-IN FEATURE. PLEASE SET TO ON FOR STANDARD OPERATIONS. IF YOU WISH THE GAME SETTING TO BE PLAYED BY 1 PLAYER ONLY (ADVISABLE FOR BEGINNERS), SET TO OFF.
DEFAULT	RESETS ALL THE SETTINGS TO THE FACTORY DEFAULTS. (INITIALIZE) NOT ONLY THE GAME CONFIGURATION BUT ALSO THE SETTINGS IN NAOMI SYSTEM MENU (COIN ASSIGNMENTS, ETC.) WILL BE RESET TO THE FOLLOWING FACTORY DEFAULTS. ADVERTISE SOUND : ON MONITOR TYPE : HORIZONTAL COIN CHUTE TYPE : COMMON COIN/CREDIT SETTING : #12 (2 COINS 1 CREDIT) SEQUENCE SETTING : SEQ1=1 (1 CREDIT TO START) SEQ2=1 (1 CREDIT TO CONTINUE) FOR MORE DETAILS REGARDING THE NAOMI SYSTEM MENU, PLEASE REFER TO THE "NAOMI SERVICE MANUAL."
SAVE & EXIT	SAVES YOUR GAME CONFIGURATION AND COIN/SYSTEM ASSIGNMENTS AND RETURNS TO THE GAME TEST MODE. (IT TAKES APPROXIMATELY 2 SECONDS TO SAVE THE SETTINGS. PLEASE DO NOT TURN OFF THE POWER WHILE SAVING.)

GAME CONFIGURATION OPTIONS

SOUND MODE	STEREO				MONAURAL			
DEMO SOUND HALF	ON				OFF			
CONTINUE	ON				OFF			
DIFFICULTY	1 EASY	2	3	4	5	6	7	8 HARD
DAMAGE LEVEL	1 LOW		2		3		4 HIGH	
TIMER SPEED	1 SLOW		2		3		4 FAST	
GAME SPEED	FREE SELECT			NORMAL		TURBO		
EVENT	ON				OFF			
JOIN-IN	ON				OFF			

NOTE: **FACTORY SETTING**

Sound setting and output terminal (please refer to GAME CONFIGURATION to set the SOUND MODE)

SOUND MODE	OUTPUT TERMINAL	SOUND
STEREO	JAMMA HARNESS ONLY	MONAURAL
	STEREO OUT	STEREO
MONAURAL	JAMMA HARNESS ONLY	MONAURAL
	STEREO OUT	

In case you wire both "JAMMA harness" and "Stereo Out," the sound will only go through "Stereo Out" and not the JAMMA harness.

Table 1: JAMMA Harness Connections

SOLDER SIDE			COMPONENT SIDE
GND	A	1	GND
GND	B	2	GND
+5V DC	C	3	+5V DC
+5V DC	D	4	+5V DC
N/C.	E	5	N/C.
+12V DC	F	6	+12V DC
KEY	H	7	KEY
N/C	J	8	COIN COUNTER 1
COIN LOCK 2	K	9	COIN LOCK 1
*SPEAKER (-)	L	10	*SPEAKER (+)
N/C.	M	11	N/C.
VIDEO GREEN	N	12	VIDEO RED
VIDEO SYNC	P	13	VIDEO BLUE
SERVICE (FREE CREDIT)	R	14	VIDEO GROUND
N/C	S	15	DIAGNOSTICS
2 PLAYER COIN	T	16	1 PLAYER COIN
2 PLAYER START	U	17	1 PLAYER START
2 PLAYER UP	V	18	1 PLAYER UP
2 PLAYER DOWN	W	19	1 PLAYER DOWN
2 PLAYER LEFT	X	20	1 PLAYER LEFT
2 PLAYER RIGHT	Y	21	1 PLAYER RIGHT
2 PLAYER LIGHT PUNCH (SHOT 1)	Z	22	1 PLAYER LIGHT PUNCH (SHOT 1)
2 PLAYER HEAVY PUNCH (SHOT 2)	a	23	1 PLAYER HEAVY PUNCH (SHOT 2)
2 PLAYER PARTNER A (SHOT 3)	b	24	1 PLAYER PARTNER A (SHOT 3)
N/C	c	25	N/C
N/C	d	26	N/C
GND	e	27	GND
GND	f	28	GND

Table 2: Test Switch/Service Switch Wiring Chart

Wiring of the test bracket requires connections to the main JAMMA harness.

SWITCH FUNCTION	CONNECTS TO
TEST	JAMMA "15"
SERVICE	JAMMA "R"
GROUND	JAMMA "A", "B", "E", "F", "1", "2", "27" OR "28"

Table 3: Auxiliary Cable (P/N 03-0105) Connections

WIRE COLOR	CONNECTOR ODD ROW		CONNECTOR EVEN ROW	WIRE COLOR
	N/C	1	2	N/C
	N/C	3	4	N/C
	N/C	5	6	N/C
	N/C	7	8	N/C
PURPLE/YELLOW	PLAYER 2 PARTNER B	9	10	N/C
	N/C	11	12	N/C
	N/C	13	14	N/C
PINK	PLAYER 1 PARTNER B	15	16	N/C
RED	PLAYER 1 HEAVY KICK	17	18	N/C
BLUE	PLAYER 1 LIGHT KICK	19	20	N/C
GRAY/YELLOW	PLAYER 2 LIGHT KICK	21	22	N/C
PINK/YELLOW	PLAYER 2 HEAVY KICK	23	24	N/C
	N/C	25	26	N/C
	N/C	27	28	N/C
GRAY/YELLOW	N/C	29	30	N/C
BLACK/WHITE	N/C	31	32	N/C
BLACK	PLAYER 2 KICK - COMMON	33	34	PLAYER 1 KICK-COMMON
				BLACK

REFERENCE INFORMATION

PC BOARD CONNECTIONS AND CONTROLS

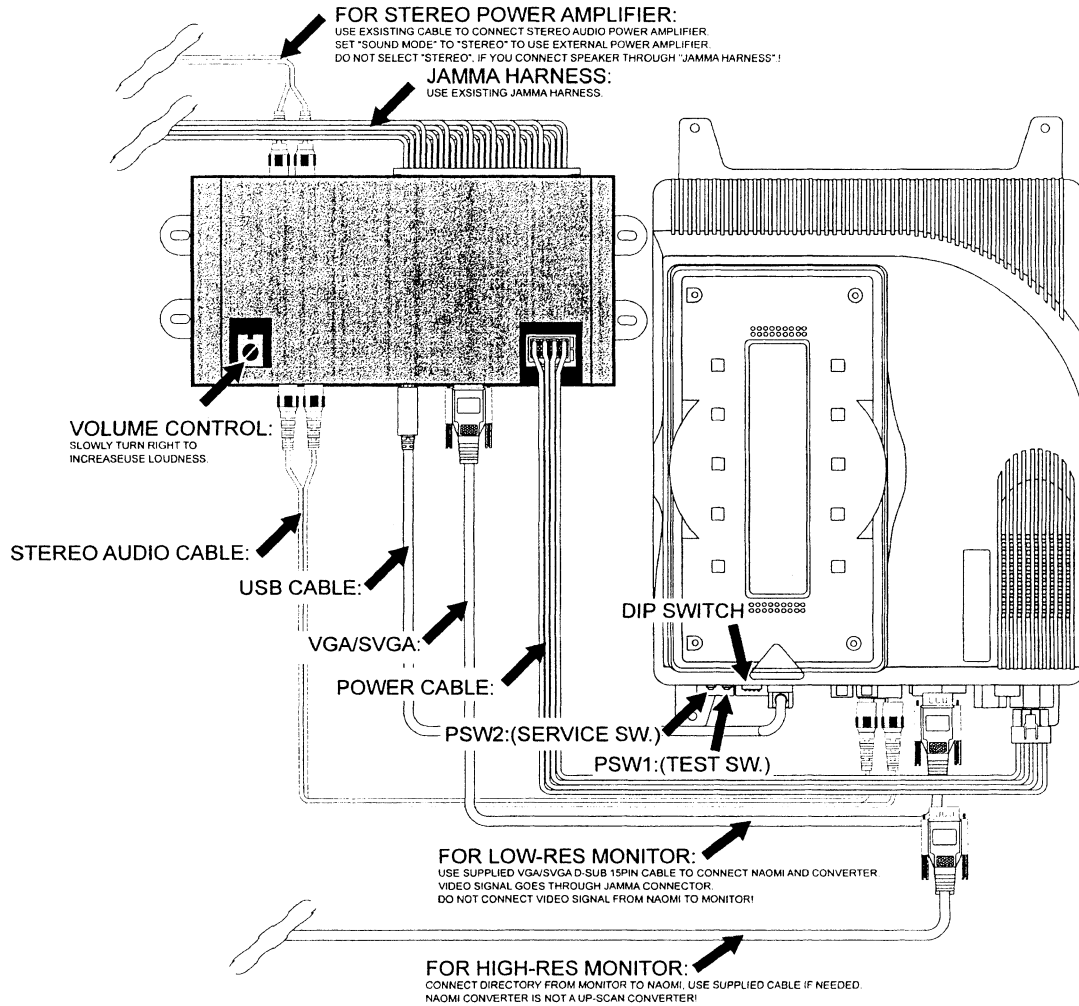

TYPICAL CONTROL PANEL LAYOUTS FOR "MARVEL VS. CAPCOM 2™"

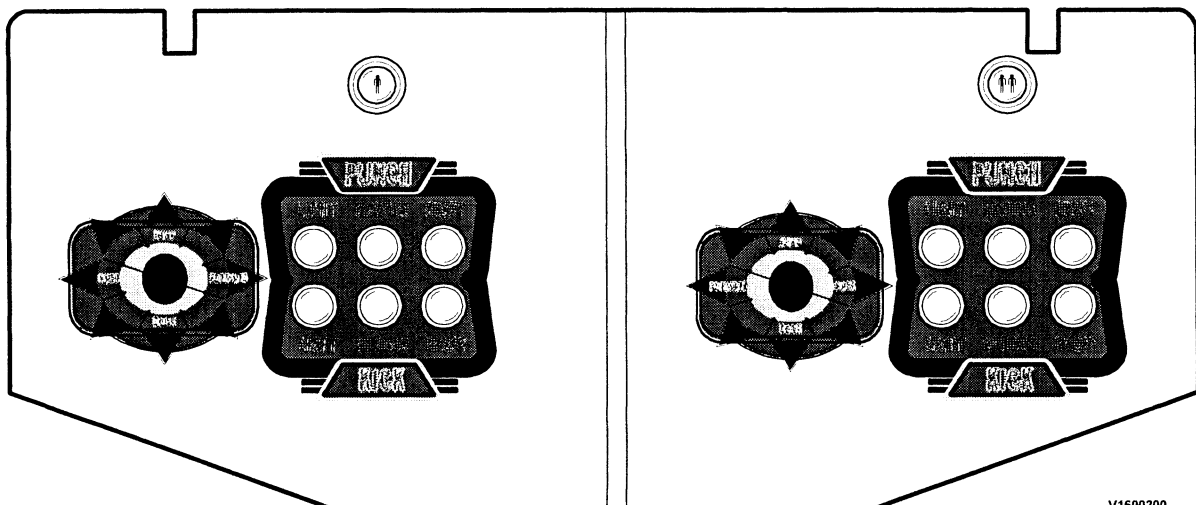

V1600200

WARNINGS & NOTICES

WARNING

A very small portion of the population has a condition which may cause them to experience epileptic seizures or have momentary loss of consciousness when viewing certain kinds of flashing lights or patterns that are present in our daily environment. These persons may experience seizures while watching some kinds of television pictures or playing certain video games. People who have not had any previous seizures may nonetheless have an undetected epileptic condition.

If you or anyone in your family has experienced symptoms linked to an epileptic condition (e.g. seizures or loss of awareness), immediately consult your physician before using any video games. We recommend that parents observe their children while they play video games. If you or your child experience the following symptoms: dizziness, altered vision, eye or muscle twitching, involuntary movements, loss of awareness, disorientation, or convulsions, DISCONTINUE USE IMMEDIATELY

WARNING

Federal law provides severe civil and criminal penalties for the unauthorized reproduction, distribution, or exhibition of copyrighted audiovisual works and video games.

The Federal Bureau of Investigation investigates allegations of criminal copyright infringement.

NOTICE

This equipment has been tested and found to comply with the limits for a Class A digital device, pursuant to Part 15 of the FCC Rules. These limits are designed to provide reasonable protection against harmful interference when the equipment is operated in a commercial environment. This equipment generates, uses, and can radiate radio frequency energy and, if not installed and used in accordance with the instruction manual, may cause harmful interference to radio communications. Operation of this equipment in a residential area is likely to cause harmful interference, in which case the user will be required to correct the interference at his own expense.

NOTICE

Information in this manual is subject to change without notice. CAPCOM COIN-OP, INC. reserves the right to make improvements in equipment function, design, or components as progress in engineering or manufacturing methods may warrant.

NOTICE

No part of this publication may be reproduced by any mechanical, photographic, or electronic process, or in the form of a photographic recording, nor may be transmitted, or otherwise copied for public or private use, without permission from the publisher.

CAPCOM[®] COIN-OP, INC.

475 Oakmead Parkway
Sunnyvale, CA 94086
Phone: (408) 774-0500
Fax: (408) 522-5331