

This document has been downloaded from:



The largest resource for amusement machines  
documentation on the world wide web!



**FLIPPERSPILL.COM**



# MISSILE

Operation, Maintenance  
and Service Manual  
Complete with Illustrated Parts Lists

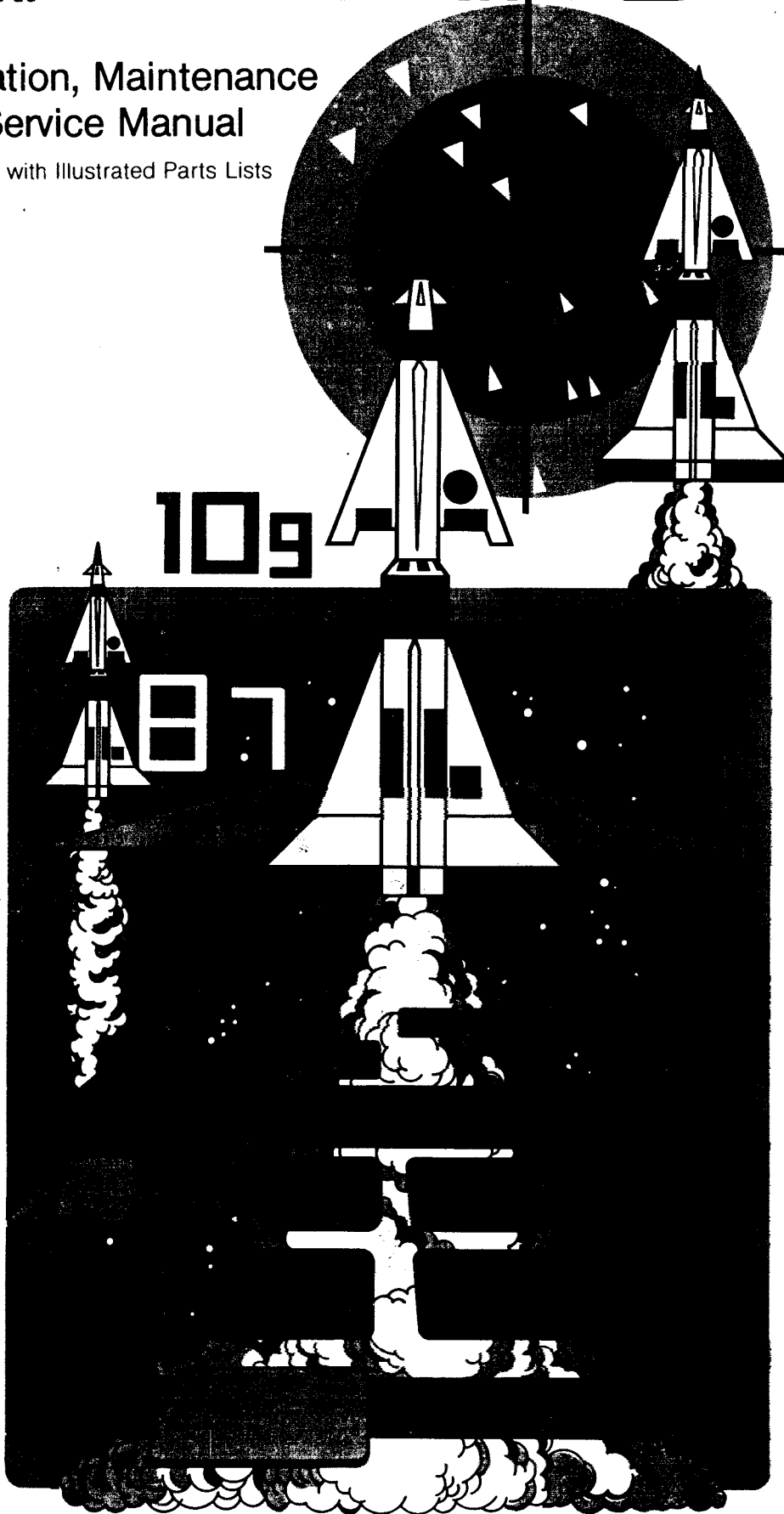

# COMMINVENT

TM

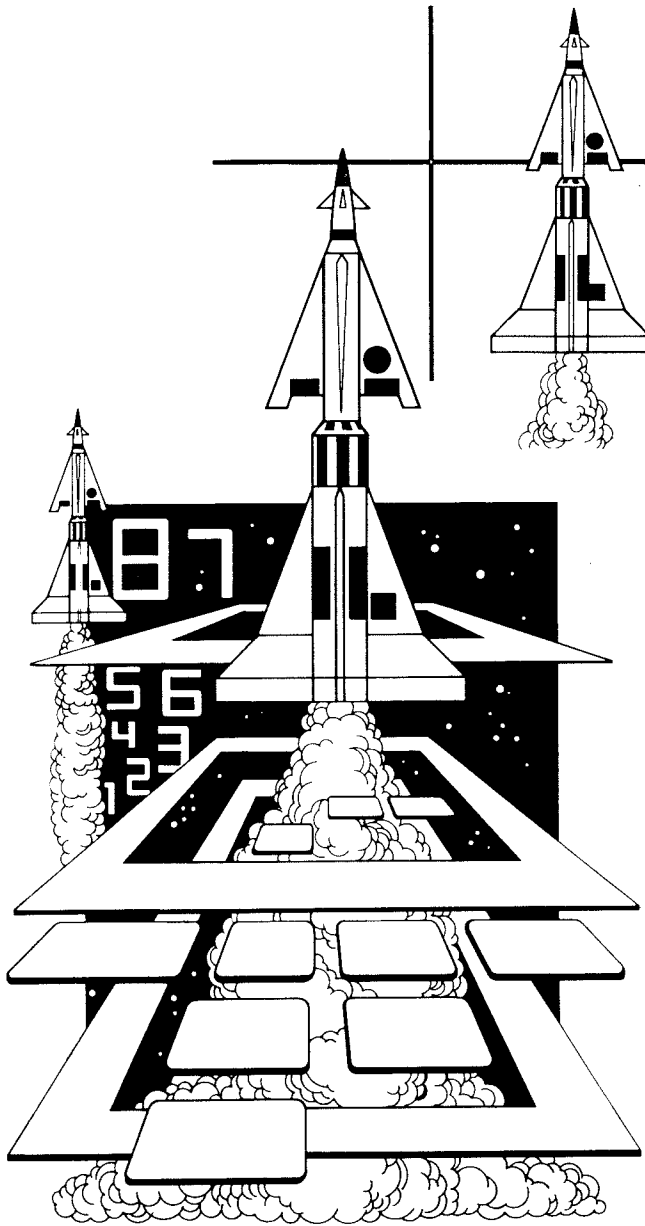

# Location Setup

## A. New Parts

The Missile Command™ game has four new parts. If you have worked on Atari games in the past, then you should be aware of these important differences. The new parts are:

- Color TV Monitor. Made especially to Atari specifications, the 19-inch monitor has been color-converged at the factory. All convergence adjustments are cemented and locked in place, to prevent accidental changes. This helps provide higher reliability for the service technician.
- Isolation Transformer. The color TV monitor chassis in this game does not contain an isolation transformer. Atari has mounted an isolation transformer on the floor of the cabinet to protect operators. **If you service this color TV on a test bench, you must isolate the line voltage!** (See instructions on pages 14-15.)

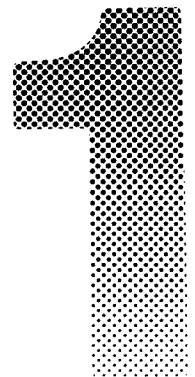

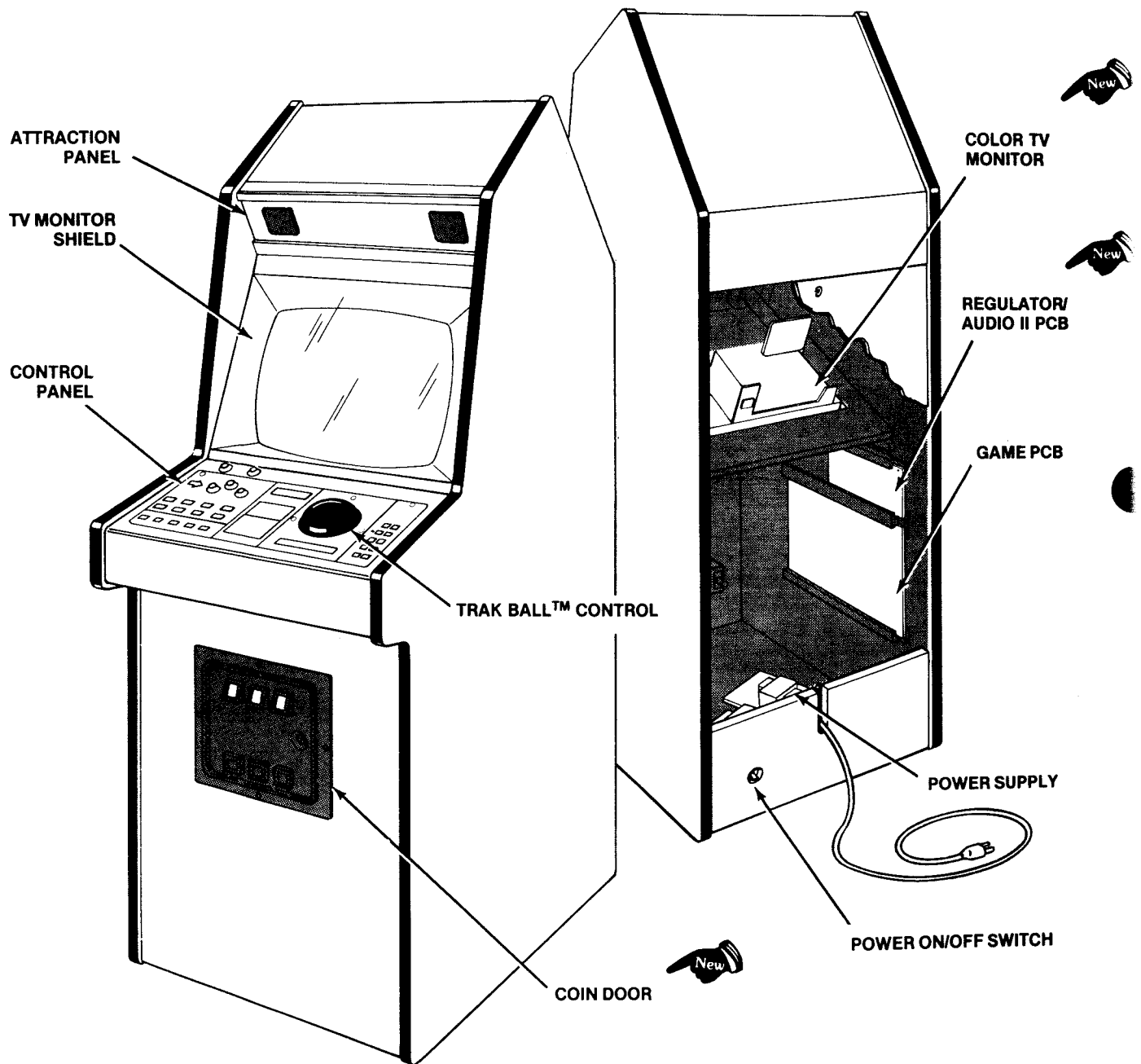



Figure 1 Overview of Game

- Regulator/Audio II PCB. This slightly redesigned printed-circuit board has two additional voltage regulators for games using 2708 EPROM memory chips. The board's new +12V and -5V regulators are both mounted on the heat sink. Otherwise this board is the same as past Regulator/Audio PCBs.
- New Coin Door. This door will accommodate two or three mechanisms, and up to four coin counters. Its triple-arm locking bar provides added security. For greater ease of access, the self-test switch is now mounted on the door, rather than inside the cabinet.

These new parts, as well as all other major parts in the game, are illustrated in Figure 1. Throughout this manual, wherever one of these new parts is mentioned, you will see this symbol: 

## B. Game Inspection

This new game is ready to play upon removal from the shipping carton. However, your careful inspection is needed to supply the final touch of quality control. Please follow these steps to help us insure that your new game was delivered to you in good condition.

### NOTE

Do not plug the game in yet!

1. Examine the exterior of the game cabinet for dents, chips, or broken parts.
2. Unlock and open the access panel of the cabinet and inspect the interior of the game as follows:
  - Check that all plug-in connectors (on the game harness) are firmly seated. Replug any connectors found unplugged. **DON'T FORCE CONNECTORS TOGETHER.** The connectors are keyed so they only go on in the proper orientation. **A reversed edge connector will damage a PCB.**
  - Check that all plug-in integrated circuits on the game PCB are firmly seated in their sockets.

### WARNING

To avoid possible unpleasant electrical shock, do not touch internal parts of the TV monitor with your hands or metal objects held in your hands!

- Note the location of the game's serial number—it is on the metallic label on the back of the game cabinet. Verify that the serial numbers also stamped on the game PCB, Regulator/Audio II PCB and TV monitor are all identical. A drawing of the serial number locations is on the inside front cover of this manual. Please mention this number whenever you call your distributor for service.
- Check all major subassemblies such as the power supply, control panel and TV monitor for secure mounting.

## C. Game Installation

### Figure 2 Installation Requirements

Power	150 watts
Temperature	0 to 38° C (32 to 100° F)
Humidity	Not over 95% relative
Space Required	64 x 83 cm (25¼ x 32¾ in.)
Game Height	186 cm (73¼ in.)

### 1. Voltage Selection

Before plugging in your game, make sure that the voltage selection plug on the power supply (see Figure 3) is correct for your location's line voltage. *Check the wire color on the plug and see if it is correct per the list below.*

#### Line Voltage Range Voltage Selection Plug Color

86-104 VAC (95)	Black
100-125 VAC (110)	Orange
190-220 VAC (205)	Green
210-240 VAC (220)	Red

### 2. Interlock and Power On/Off Switches

To minimize the hazard of electrical shock while working on the inside of the game cabinet, two interlock switches have been installed (see Figure 4). One is located behind the access panel and one is behind the coin door. These switches remove all AC line power from the game circuitry when a door or panel is opened.

Check for proper operation of the interlock switches by performing the following steps:

- Unlock and open the access panel and the coin door.
- Plug the AC line power cord into an AC outlet.

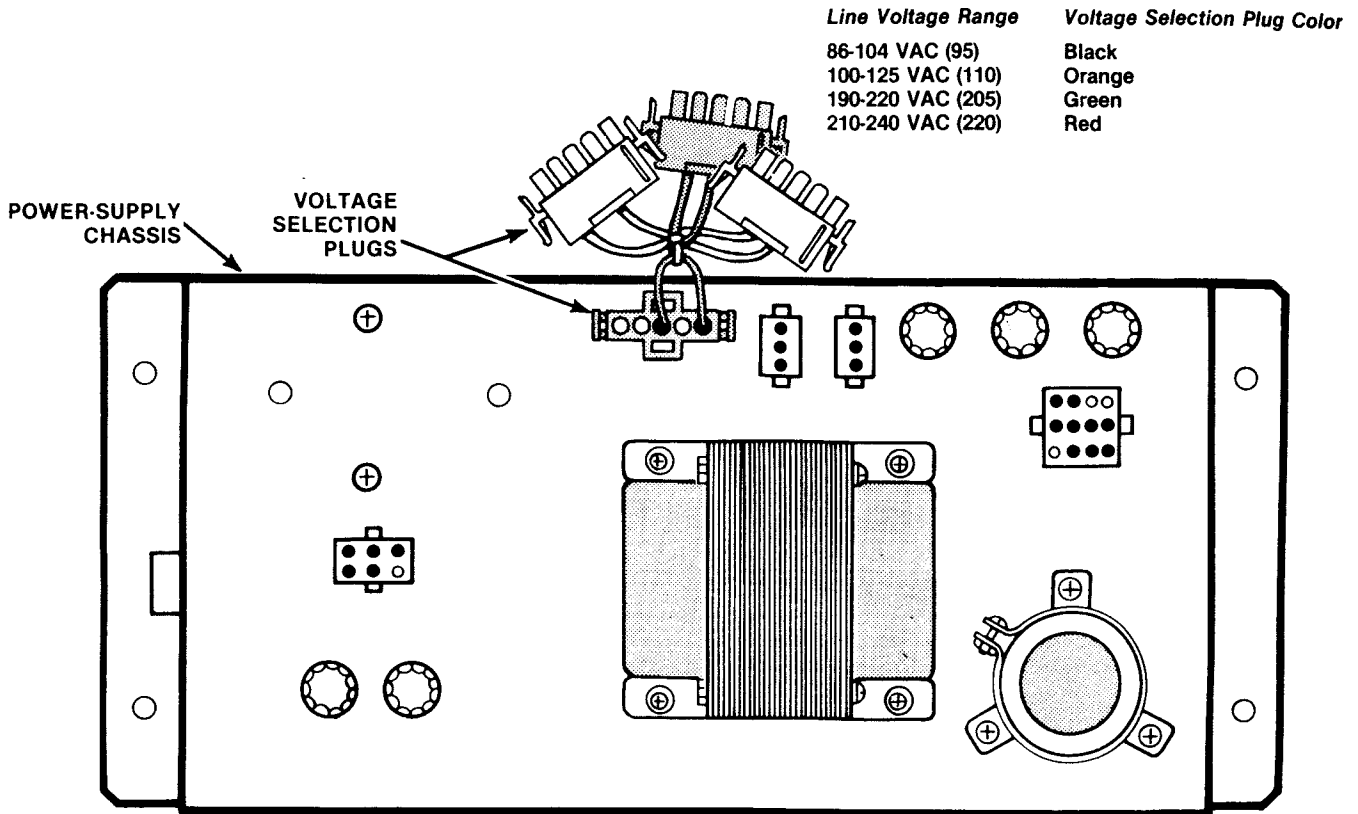

**Figure 3 Power Supply**

- Close the access panel and coin door.
- Set the power on/off switch to the on position. Within approximately 30 seconds the TV monitor should display a picture.
- Slowly open the rear access panel. The TV monitor picture should disappear when the panel is opened approximately 2.5 cm (1 inch). Close and lock the access panel and repeat this step with the coin door.
- If the results of the previous step are satisfactory, the interlock switches are operating properly. If the TV monitor doesn't go off as described, check to see if the corresponding interlock switch is broken from its mounting or stuck in the on position.

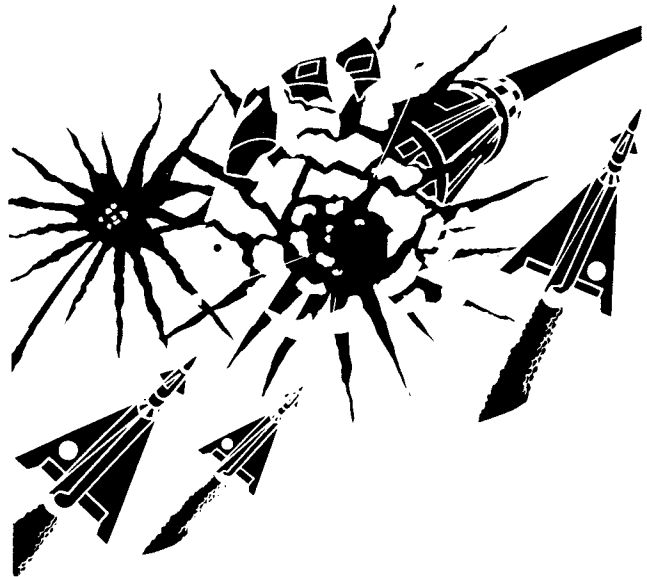

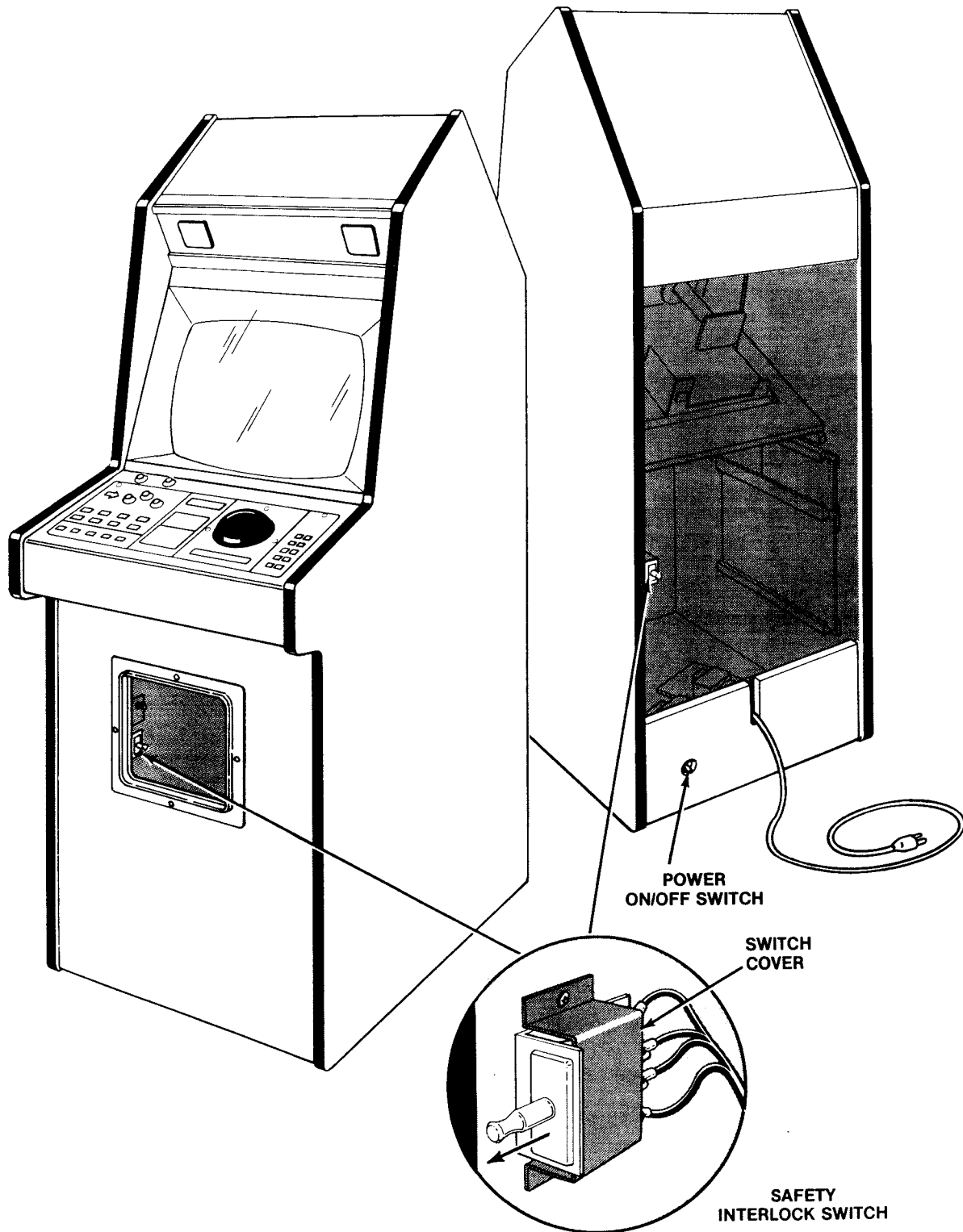

**Figure 4 Interlock and Power On/Off Switches**

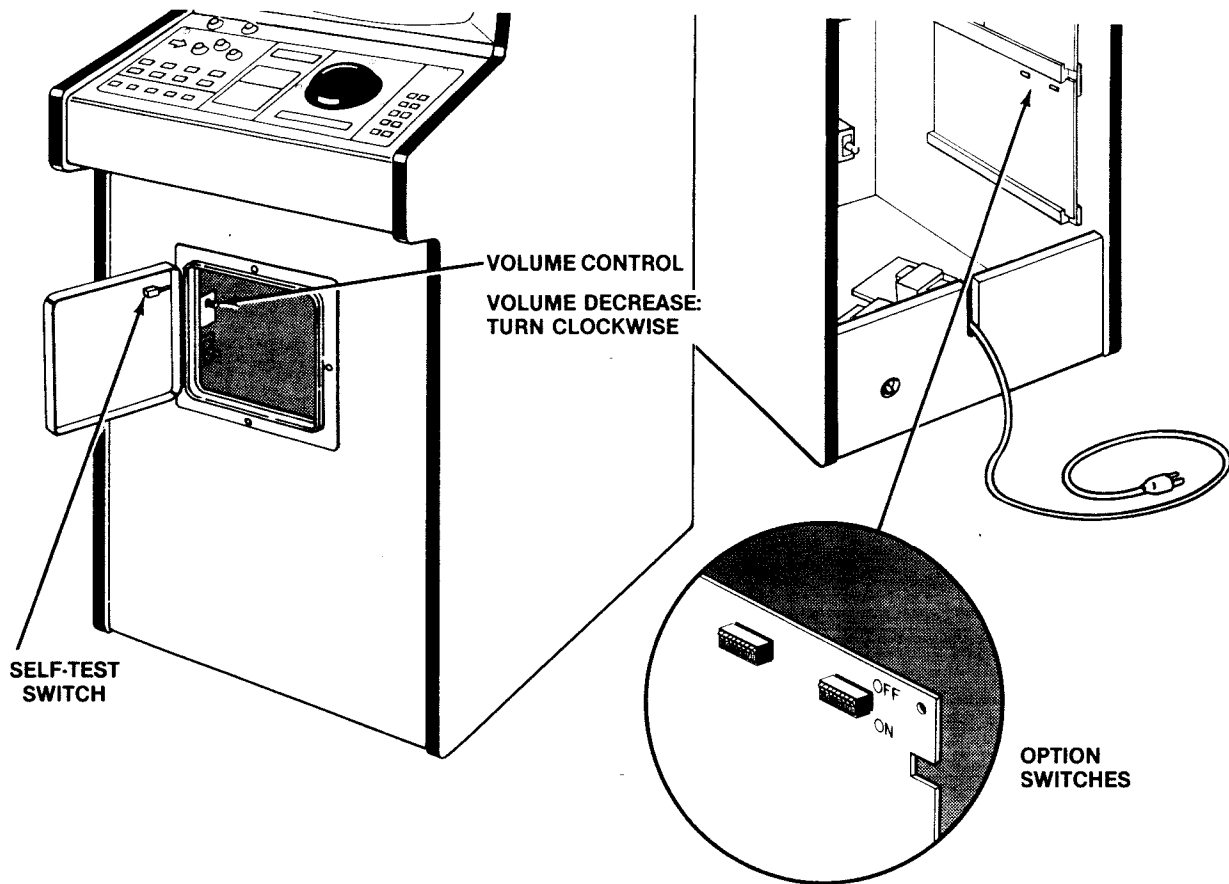

**Figure 5 Location of Self-Test Switch, Volume Control and Option Switches**

---

## D. Self-Test Procedure

This game will test itself and provide data to demonstrate that the game's circuitry and controls are operating properly. The data is provided on the TV monitor and the game speaker; no additional equipment is necessary.

Part of the self-test procedure includes a display of the operator-selectable game options. Therefore, we suggest you run the self-test procedure anytime you need to change the game's options.

To run the self-test, follow the instructions outlined in Figure 6.

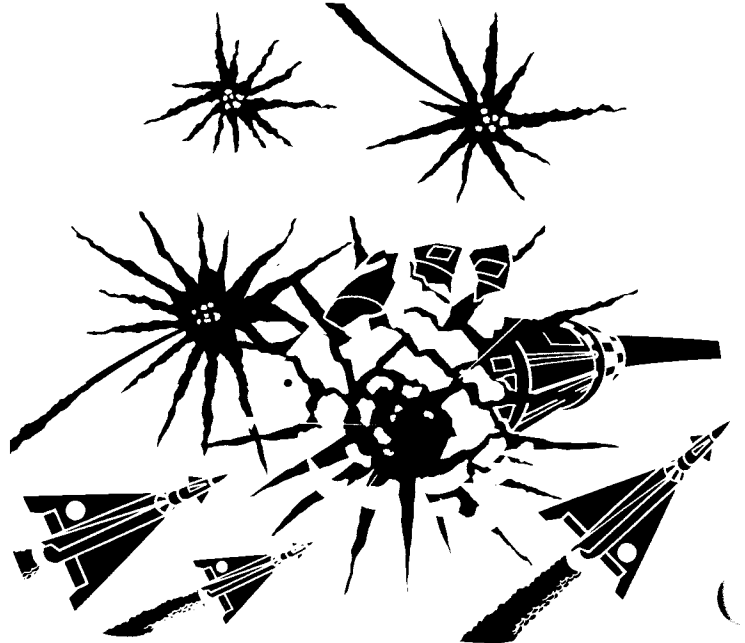



## Figure 6 Self-Test Procedure

Instruction	Result if Test Passes	Result if Test Fails
<p>1. Set self-test switch to <b>on</b> position (see Figure 5). Note: entering self-test will set the HIGH SCORE TODAY display to 7500.</p>	<p>After about 5 seconds of frozen attract mode, a low raspy tone is followed by a low beep, then high beep. TV monitor screen displays picture as shown below:</p> <p style="text-align: center;">ROM OK MAP OK RAM OK +</p> <p>...plus the options display—see Figure 7 for explanation. Both LED start buttons will also be lighted.</p>	<p>A continuous raspy tone means V BLANK is malfunctioning. Self-test will not continue.</p> <p>A RAM failure is indicated by a blank or "garbage"-filled screen and a repeated series of 8 beeps, separated by a low raspy tone. See note 1 below. Self-test will not restart.</p> <p>ROM failure is indicated by <b>BAD ROM</b>; see note 2 below.</p> <p><b>BAD MAP</b> means bit-mapping hardware has failed.</p> <p><b>BAD CHIP</b> means custom audio I/O chip at location P8/9 has failed.</p>
<p>2. Roll the Trak Ball control in all directions.</p>	<p>The + moves around on the screen in directions corresponding to Trak Ball control—up to an invisible border along the screen's edges.</p>	<p>The + doesn't move in same direction as ball, or not at all. One of the Steering PCBs on Trak Ball control may be bad, harness wires or connector may be loose, Trak Ball reading circuitry on Game PCB may be bad, or Trak Ball bearings may need oiling.</p>
<p>3. Press the following switches:</p> <ul style="list-style-type: none"> <li>● Coin switch trip wires</li> <li>● Coin door slam switch</li> <li>● All three fire switches</li> <li>● Player start buttons</li> </ul>	<p>A sound is heard as each switch is pressed. The background color also changes.</p>	<p>No sound or color changes are produced when pressing one of these switches: indicates a bad switch, loose harness wires, or loose connector.</p>
<p>4. Set self-test switch to <b>off</b> position.</p>		

**Note 1:** In test no. 1, a low beep means a good chip; a high beep is a bad RAM, as follows:

High beep in series of 8 tones:	Bad chip at location:
1st	P4
2nd	N4
3rd	M4
4th	L4
5th	K4
6th	J4
7th	H4
8th	F4

**Note 2:** **BAD ROM** plus some or all of the digits 1 thru 6 are displayed. These numbers show which 2K of memory are bad. For example, 1 means the first 2K are bad. The + may not appear.

## Figure 7 Option Switch Settings

To change toggle positions on the switch assemblies, you need not remove the game PCB. The switches, usually colored blue, are easily accessible when the game PCB is mounted in place.

When changing the options, verify proper results on the TV monitor display **by performing the self-test**. Note that changing an option on any toggle will cause an immediate change on the TV monitor screen during the self-test.

Toggle Settings of 8-Toggle Switch on Game PCB (at R10)								Option
8	7	6	5	4	3	2	1	
						On	On	1 coin* for 1 play
						Off	On	Free play
						On	Off	2 coins* for 1 play \$
						Off	Off	1 coin* for 2 plays
Used				On	On			Right coin mech × 1 \$
				On	Off			Right coin mech × 4
				Off	On			Right coin mech × 5
				Off	Off			Right coin mech × 6
Not			On					Center Coin Mech × 1 \$ (Center mech is a left mech in a 2-mech door)
			Off					Center Coin Mech × 2
	On	On						English language
	On	Off						French language
	Off	On						German language
	Off	Off						Spanish language

Toggle Settings of 8-Toggle Switch on Game PCB (at R8)								Option
8	7	6	5	4	3	2	1	
						Off	Off	Game starts with 7 cities
						On	On	Game starts with 6 cities \$
						Off	On	Game starts with 5 cities
						On	Off	Game starts with 4 cities
Used					On			No bonus credit
					Off			1 bonus credit for 4 successive coins \$
				On				Large Trak Ball input \$
				Off				Mini-Trak Ball input (Switch must be on for proper operation of large Missile Command game)
Not	Off	Off	On					Bonus city every 8,000 points
	On	On	On					Bonus city every 10,000 points \$
	On	On	Off					Bonus city every 12,000 points
	On	Off	On					Bonus city every 14,000 points
	On	Off	Off					Bonus city every 15,000 points
	Off	On	On					Bonus city every 18,000 points
	Off	On	Off					Bonus city every 20,000 points
	Off	Off	Off					No bonus city

The format of the self-test display is as follows:

Bonus city every \_\_\_\_\_ points (line disappears if no bonus city is chosen)

+

Coinage setting

4, 5, 6, or 7 cities (always in English)

A      B      C      D

A is the center mech multiplier for 3-mech doors, left mech multiplier if a 2-mech door. This number is either 1 or 2.

B is the right coin mech multiplier and is 1, 4, 5, or 6.

C is an "F" if switch 4 (of R8) is off.

D is an "X" if switch 3 (of R8) is off.

An example of an actual option switch display is as follows:

**BONUS CITY EVERY 10,000 POINTS**

+

**2 COINS 1 PLAY**

**6 CITIES**

1      1                      X

\* Note: In the U.S., a "coin" is defined as 25¢. If your game also has a \$1 mechanism, you must set the right coin mechanism multiplier as per your choice.

\$ Manufacturer's suggested settings

## E. Game Play

Missile Command™ is a 1- or 2-player game with a color monitor. The game depicts an Armageddon-style war in which players defend their bases and cities with antiballistic missiles (ABMs). The enemy—the game computer—launches incoming waves of attack missiles. These weapons may be either individual or branching attack missiles. In addition, the enemy occasionally launches missiles from a fast-moving “killer” satellite or from bombers. The enemy also launches “smart” missiles that usually avoid explosions.

Players receive varying numbers of points for intercepting attack missiles, for having unused missiles still in their bases' arsenals, and for having their cities undamaged after a missile wave.

The game has five possible modes of operation: attract, ready-to-play, play, high-score initial, and self-test. The latter is a special mode for checking the game switches and computer functions. You may enter this mode at any time. When entered, all game credits are cancelled, and the “HIGH SCORE TODAY” is reset to 7500. A list of eight “highest” scores and initials are also reset onto the screen (to provide player challenge).

### 1. Attract Mode

The attract mode begins when power is applied to the game, after a play or high-score initial mode, or after self-test. This mode is continuous and is only interrupted when a game is paid for and accepted, or when entering self-test.

In this mode, the *Missile Command* name is displayed, then the computer plays one wave—handling both offense and defense. Following this, the computer displays the high score table, then the *Missile Command* graphics reappear.

### 2. Ready-to-Play Mode

This mode begins when sufficient coins have been accepted for a one- or two-player game. It ends when the 1 PLAYER START or 2 PLAYER START pushbutton is pressed.

When this mode begins, the message **PRESS START** scrolls along the bottom of the screen. **DE-**

**FEND CITIES** and red arrows pointing down to each city also appear on the screen. The displayed pictures are otherwise the same as those shown in the attract mode.

### 3. Play Mode

The play mode begins when either start pushbutton is pressed. The mode ends when the player's last city is destroyed.

The three bases—Alpha, Delta and Omega—each have 10 ABMs ready to be fired (shown as 's). Players must be careful to fire the missiles more or less evenly from among those bases, because no more missiles are granted until the screen resets in preparation for a new wave of attack missiles. If the enemy missiles strike a city or base, the colorful buildings or base will change to the solid color of the landscape.

The game continues until all cities are destroyed. Missile Command™ has no operator-selectable fixed time length. Thus a highly skilled player can play longer than the novice.

During the second wave, a “killer” satellite and/or bomber will appear on the screen, moving quickly and launching attack missiles at the bases and cities. Players get bonus points for shooting down the satellites or bombers.

The general approach for getting high point scores is fairly quickly discovered: try to launch your ABMs when the enemy missiles have just appeared at the top of the screen. Then they are clustered together, where one ABM can usually destroy several enemy missiles. In the later more advanced waves, players can lay out a blanket of explosions.

### 4. High Score Initial Mode

If a player's score exceeds the minimum on the high score initial list, he or she may put up to three initials on this list at the end of the game. Spinning the Trak Ball control changes the letters (A thru Z and a blank are available). Pressing any fire switch will fix that letter on the screen, and move the choice to the next letter. If the player doesn't enter his or her initials within 90 seconds, three blank spaces will be entered automatically.

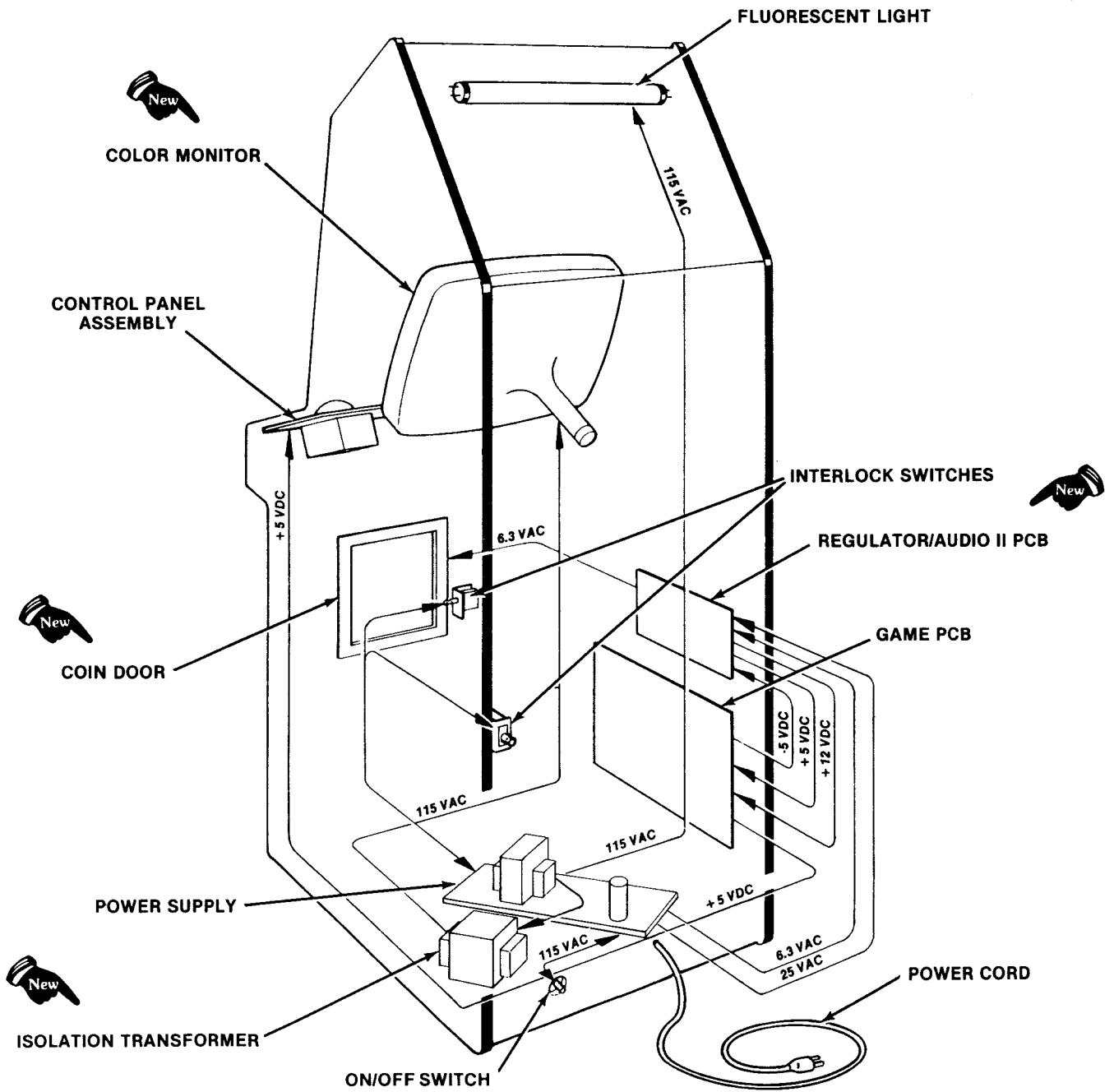

Figure 16 Power Distribution

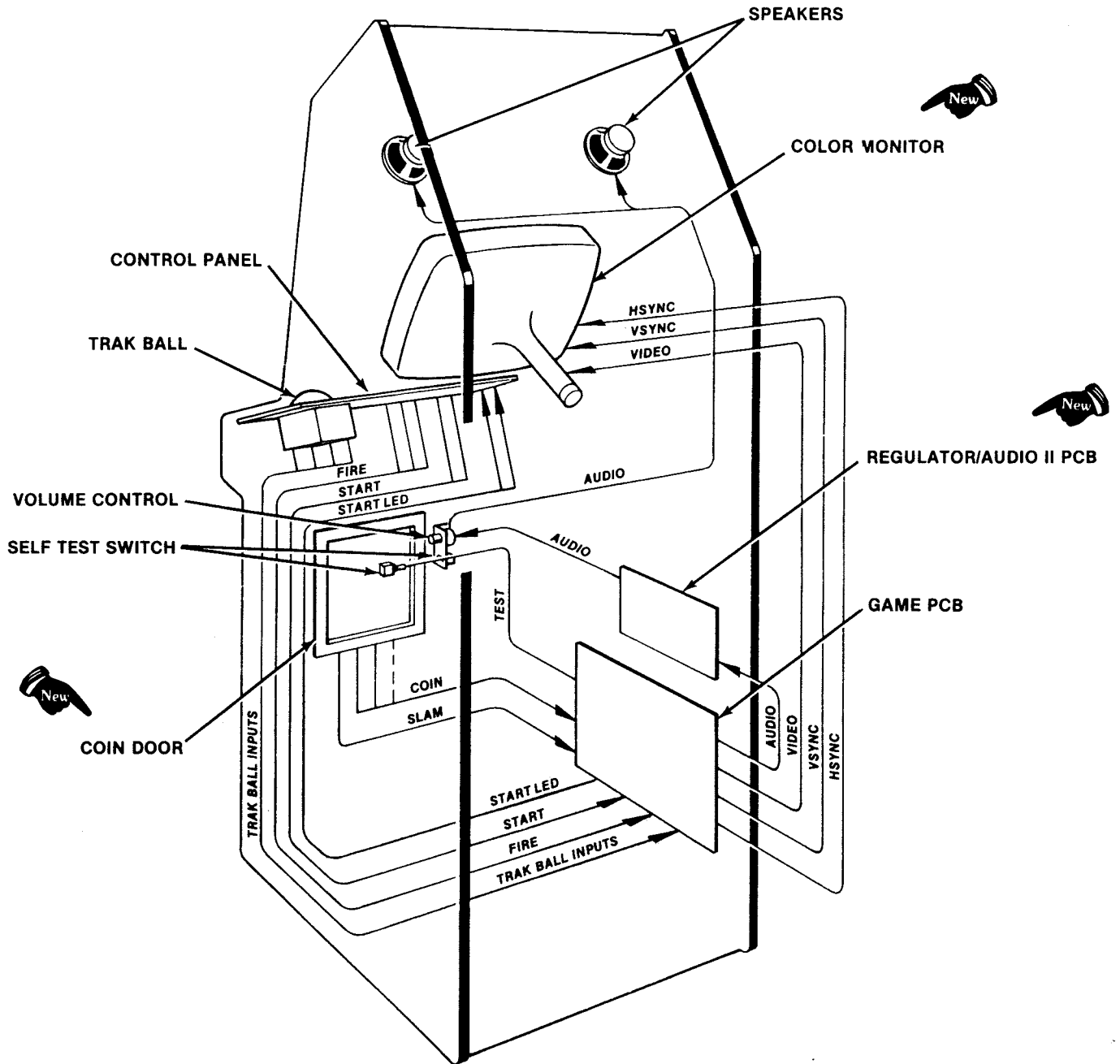

Figure 17 Signal Distribution

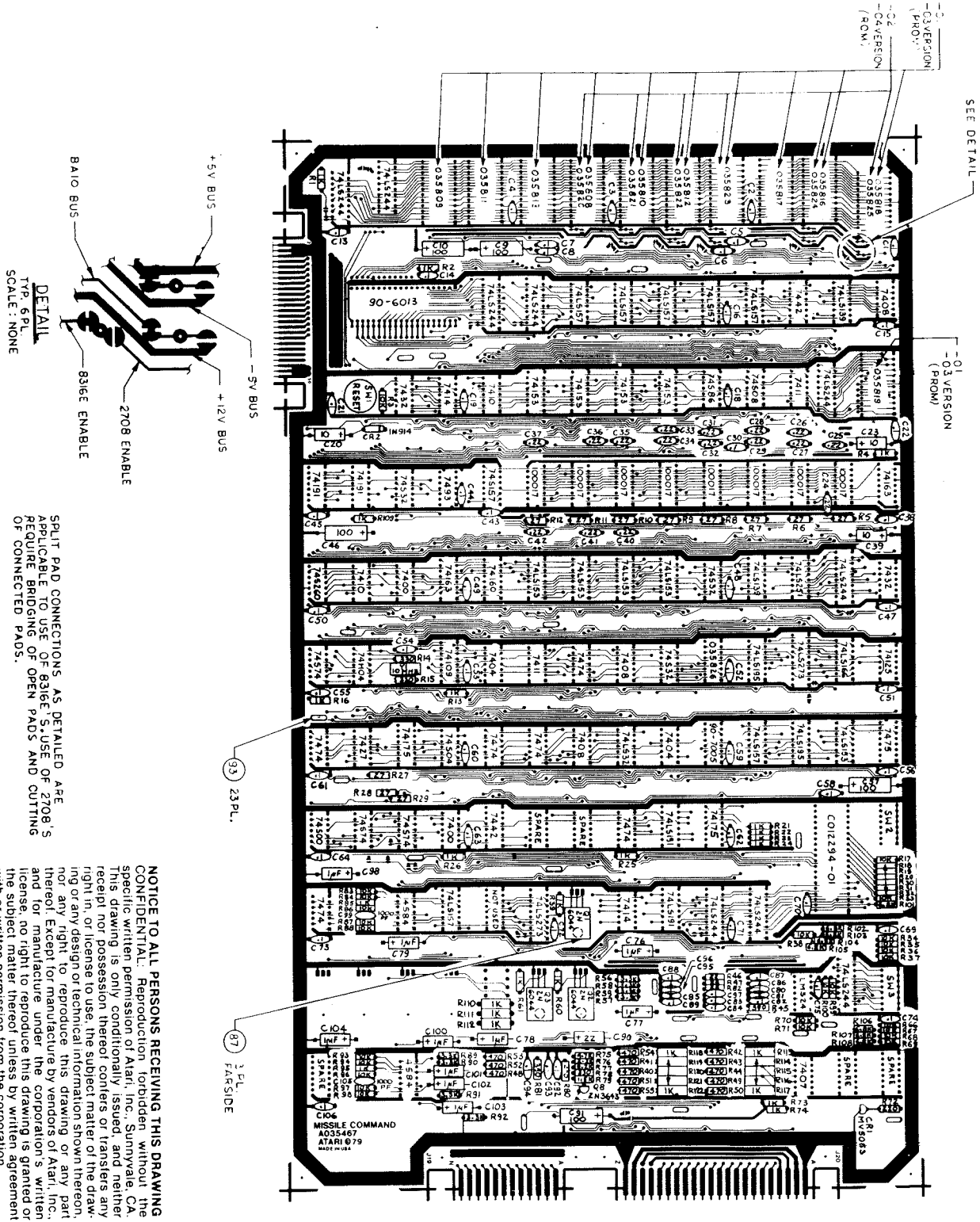

Figure 25 Game PCB Assembly  
A035467-01 thru -04 D

## Figure 25 Game PCB Assembly Parts List

### *Memory Components and Their Equivalents (Locations Shown in Bold)*

-01 P.C. Boards (mostly PROMs)	-02 P.C. Boards (ROMs)	-03 P.C. Boards (mostly PROMs)	-04 P.C. Boards (ROMs)
035812-01 <b>K/L1</b>	035822-01 <b>K/L1</b>	035812-02 <b>K/L1</b>	035822-02 <b>K/L1</b>
035813-01 <b>F1</b>		035813-02 <b>F1</b>	
035823-01 <b>L/M1</b>	035823-01 <b>L/M1</b>	035823-02 <b>L/M1</b>	035823-02 <b>L/M1</b>
035816-01 <b>N/P1</b>	035824-01 <b>N/P1</b>	035816-02 <b>N/P1</b>	035824-02 <b>N/P1</b>
035817-01 <b>M/N1</b>		035817-02 <b>M/N1</b>	
035818-01 <b>R1</b>	035825-01 <b>R1</b>	035818-02 <b>R1</b>	035825-02 <b>R1</b>
035819-01 <b>R3</b>		035819-02 <b>R3</b>	
035808-01 <b>H1</b>	035820-01 <b>H1</b>	035808-02 <b>H1</b>	035820-02 <b>H1</b>
035809-01 <b>D1</b>		035809-02 <b>D1</b>	
035810-01 <b>J/K1</b>	035821-01 <b>J/K1</b>	035810-02 <b>J/K1</b>	035821-02 <b>J/K1</b>
035811-01 <b>E1</b>		035811-02 <b>E1</b>	