

This document has been downloaded from:



The largest resource for amusement machines
documentation on the world wide web!



FLIPPERSPILL.COM

757

MIDWAY

August 1992
16-43125-101

MORTAL KOMBAT KIT



OPERATIONS MANUAL

- * Installation & Operation
- * Testing & Problem Diagnosis
- * Parts Information
- * Wiring Diagrams & Schematics



Mortal Kombat Instructions

Insert Coin(s)

In a two player game, the loser pays and the winner stays.

Press the Punch and Kick buttons to attack an opponent.

Use the joystick to make the screen player jump or duck, and move left or right.

Use joystick and button combinations to discover secret moves.

MIDWAY Manufacturing Company reserves the rights to make modifications and improvements to its products. The specifications and parts identified in this manual are subject to change without notice.

Mortal Kombat Kit

TABLE OF CONTENTS

Section 1 Operation and Troubleshooting

Safety	1-2
Conversion Procedures	
Inspection.....	1-3
Converting from a STREET FIGHTER II* game cabinet.....	1-4
Suggested Control Panel Layout.....	1-5
PC Board Installation.....	1-5
Converting from a typical video game cabinet.....	1-6
Suggested Template Layout.....	1-7
Suggested Control Panel Layout.....	1-7
Installing PC Boards into a JAMMA Cabinet.....	1-8
Installing PC Boards into a Non-JAMMA Cabinet.....	1-9
Game Features	
Starting-up.....	1-10
Player Controls.....	1-10
Typical Control Panel	1-10
Game Operation	
Control Switches.....	1-11
Control Switch Location Diagram.....	1-11
Menu System Operation	
Operation.....	1-12
Main Menu.....	1-12
Diagnostic Tests.....	1-13
Switch Test.....	1-13
DIP Switch Test & Table.....	1-14
CPU & Sound Tests.....	1-15
Monitor Patterns	1-16
Burn-in Tests.....	1-16
Coin Bookkeeping.....	1-17
Game Audits.....	1-18
Game Adjustments.....	1-19
Standard Pricing Table.....	1-21
Custom Pricing Table.....	1-22
Utilities	1-23
Troubleshooting	1-24

Section 2 Parts Information

CPU Board Assembly.....	2-2
CPU Board Parts.....	2-3
Sound Board Assembly.....	2-4
Sound Board Parts.....	2-5

Section 3 Diagrams and Schematics

JAMMA Chart And Interboard Wiring.....	3-2
Cabinet Wiring.....	3-3
Coin Meter Wiring.....	3-4
CPU Board Schematic.....	3-5
Sound Board Schematic.....	3-21

Mortal Kombat Kit

S E C T I O N

one

Operation & Installation

Safety Notices

The following safety hints apply to all kit operators and service personnel. Specific warnings and cautions will be found throughout this manual where they apply. We recommend that you read this page, and also all of Section 1, before preparing your kit for play.



Notice: Salvaged Parts

Parts salvaged from old games are required to complete your kit. These salvaged parts must operate perfectly; otherwise, the converted game cannot perform properly or safely. Always repair circuit board malfunctions and cabinet damage before conversion is attempted.

Notice: Power Supply

Be sure the power supply from your old game is capable of +5V dc at 5A, -5V dc at 1A and +12V at 1A. These operating voltages are necessary for your kit. Your power supply must be FCC approved.

Notice: Monitor

This kit is not intended for use with X-Y monitors. Suitable monitors have horizontally mounted CRTs and raster electronics with inputs for red, green and blue video, as well as Composite Negative Sync inputs.

Notice: Coin Mechanism

Be sure to clean and lubricate your old coin mechanisms. Servicing them is crucial to your game's earning potential and operation.

Notice: Coin Meters

Coin meters are not provided with this kit. Wiring information is provided as a convenience to the operator.

Notice: Servicing, Installing

Always turn your game Off and unplug it before attempting to service or install your kit.

ATTENTION !

PROPERLY ATTACH ALL CONNECTORS. Be sure that the connectors on each printed circuit board (PCB) are properly connected. If they do not slip on easily, do not force them. A reversed connector may damage your kit and void the warranty. All connectors are keyed to fit specific pins on each board.

CONVERSION PROCEDURES

Inspection

Unpack the materials from the carton and inspect for obvious signs of damage. Use this checklist to be sure your kit is complete.

Part No.	Item	Quantity
<input type="checkbox"/> A-13234-40025	CPU board	1
<input type="checkbox"/> A-14732-40025	Sound board	1
<input type="checkbox"/> H-14925	Sound/Power Speaker Cable	1
<input type="checkbox"/> H-13411	Main JAMMA Cable	1
<input type="checkbox"/> H-15650	Volume Control	1
<input type="checkbox"/> H-15873	Adapter Cable for STREET FIGHTER II	1
<input type="checkbox"/> H-15874	Auxiliary Cable	1
<input type="checkbox"/> 16-9383	Controls Template	1
<input type="checkbox"/> 16-43125-101	Manual	1
<input type="checkbox"/> 20-9687-1	Pushbutton, Red	4
<input type="checkbox"/> 20-9687-2	Pushbutton, White	4
<input type="checkbox"/> 20-9687-3	Pushbutton, Blue	4
<input type="checkbox"/> 20-9694-1	8-way Joystick, Red	2
<input type="checkbox"/> 31-1612-43125	Control Panel Overlay	1
<input type="checkbox"/> 31-1644-40025-1	Marquee	1
<input type="checkbox"/> 31-1714-43125	Card & Controls Decal	1
<input type="checkbox"/> 31-1715	Cabinet Side Decal	2
<input type="checkbox"/> 5795-10937-18	20-pin Ribbon Cable	1
<input type="checkbox"/> Assorted Hardware		

Recommended Tools and Supplies

- black semi-gloss paint
- electric drill
- electric screwdriver
- grease pencil or marker
- hex driver
- 180 grit sandpaper or electric sander
- pliers
- razor knife
- soldering iron and solder
- wire cutters
- black electrical tape

Converting from a STREET FIGHTER II game cabinet

Cabinet Modifications

1. Remove the old decals and artwork and clean the glue residue . Repaint the cabinet with black semi-gloss paint. Allow paint to dry.
2. Pencil a line roughly at the top of the old graphic. Lightly moisten the cabinet with soapy water. Apply the decal starting at the top and working down. After the decal is in place, smooth it down, taking care to squeeze out the air bubbles. If you miss an air bubble, pop it with a razor blade or a pin and burnish it down. Allow 12 hours for the adhesive in the decals to set. Remove masking.
3. Check the kit for an FCC sticker and apply it over the existing sticker on the cabinet. See NOTICE to the left.
4. Apply the Game Play Instruction Decal to the CRT viewing glass. Be sure the decal does not obstruct the CRT.

NOTICE

When Midway ships a game, it is in compliance with FCC regulations. Your sticker is proof. If the sticker is missing or damaged, legal repercussions to the owner or distributor of the game may result. If your game kit does not contain an FCC sticker, call Midway Manufacturing immediately.

Control Panel Modifications

1. Remove the control panel buttons and joysticks and remove the old vinyl covering and artwork. Tagging the wires as they are removed from the pushbutton and joystick switches will make reinstallation easier.
2. Carefully remove the backing on the vinyl control panel overlay. Place the overlay on top of the control panel. Prevent air bubbles from getting under the vinyl overlay.
3. After the overlay is in place, use a razor knife to cut holes for the pushbuttons and joysticks. Position the stickers around the appropriate hole locations. See the page 1-5 for sticker locations.
4. Remove the switch from the pushbutton by pulling the large prong away from the switch, then pull the switch off the housing. Unscrew the nut from the housing. Push the switch housing through the control panel from the front. Screw the nut back onto the switch housing from the back of the control panel. Push the switch back into the switch housing.
5. Remove the "E"-ring and slide the shaft and the plastic ring off the joystick base. Be sure that the bushings remain in the base. Screw the base to the underside of the control panel. Slide the plastic ring around the shaft so that the rough side is next to the shaft handle. Slide the shaft through the control panel and base. Replace the "E"-ring.
6. Mount the volume control, using the screws provided, where it is easily accessible. On top of the cash box, or on the wall near the sound board are two possible locations.

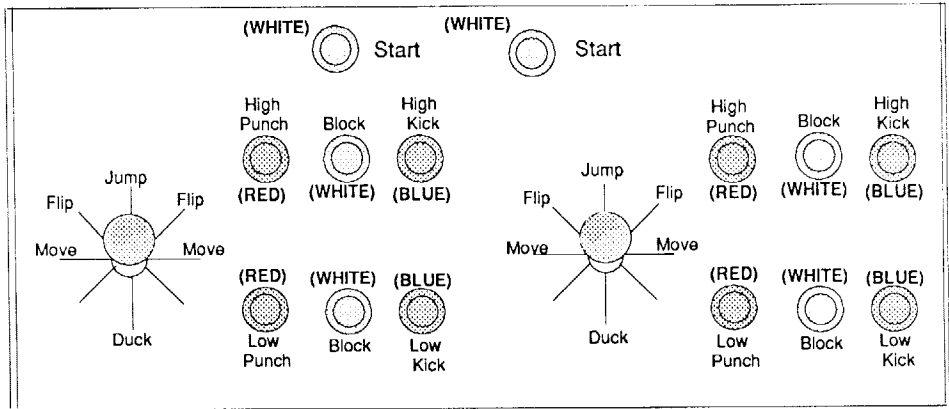

Typical control panel layout & sticker locations for modification of a STREET FIGHTER II control panel

PC Boad Installation

1. Replace the existing CPU board and sound board with the Mortal Kombat CPU board and sound board.
2. Plug the JAMMA connector into the CPU board at J1. Plug the 10-pin connector of the Adapter cable into the 10-pin JST type connector from the control panel. Be sure to match the wire colors of both connectors. Plug the other end of the Adapter cable into the CPU board at J4.
3. Connect the ribbon cable from P1 on the sound board to J8 on the CPU board. Be sure that the red line goes to the same pin on both boards. Connect the wire harness cable from P7 (speaker), and P6 (power), on the sound board to J2 (sound power speaker connector) on the CPU board.
4. J6, J7, J9 on the CPU board are not used.
5. Place the FBI Warning Label on the inside of the cabinet next to the PC boards. Be sure the label is completely visible.

Note

The ribbon cable may need to be twisted in order to connect it properly.

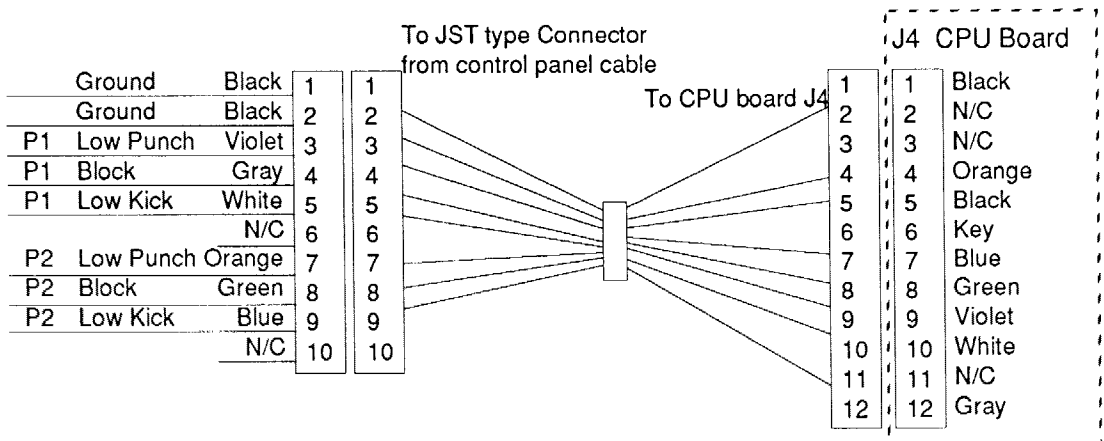

Adapter cable for STREET FIGHTER II conversion

Converting from a typical video game cabinet

Cabinet Modifications

1. Repaint the cabinet with black semi-gloss paint (games with wood grain sides: remove the old decals and artwork and clean the glue residue before painting). Allow paint to dry.
2. Pencil a line roughly at the top of the old graphic. Lightly moisten the cabinet with soapy water. Apply the decal starting at the top and working down. After the decal is in place, smooth it down, taking care to squeeze out the air bubbles. If you miss an air bubble, pop it with a razor blade or a pin and burnish it down. Allow 12 hours for the adhesive in the decals to set. Remove masking.
3. Check the kit for an FCC sticker and apply it over the existing sticker on the cabinet. See NOTICE to the left.
4. Apply the Game Play Instruction Decal to the CRT viewing glass. Be sure the decal does not obstruct the CRT.

NOTICE

When Midway ships a game, it is in compliance with FCC regulations. Your sticker is proof. If the sticker is missing or damaged, legal repercussions to the owner or distributor of the game may result. If your game kit does not contain an FCC sticker, call Midway Manufacturing immediately.

Control Panel Modifications

1. Remove the control panel buttons and joysticks and remove the old vinyl covering and artwork.
2. Use the control panel template to help you design your control panel. You will need to use the template twice. Once for the left player controls and once for the right player controls. Refer to page 1-7 for suggested template layouts.
3. Drill holes as needed for the joysticks and control panel buttons. Plug previous holes with wood blocks, putty, cardboard or epoxy. File the new holes smooth.
4. Carefully remove the backing on the vinyl control panel overlay. Place the overlay on top of the control panel. Prevent air bubbles from getting under the vinyl overlay.
5.
 - a) After the overlay is on securely, use a razor knife to cut holes for the control panel buttons and joysticks.
 - b) Position the stickers around the appropriate locations. Refer to page 1-7 for suggested control panel button and joystick sticker locations.
6. Remove the switch from the pushbutton by pulling the large prong away from the switch, then pull the switch off the housing. Unscrew the nut from the housing. Push the switch housing through the control panel from the front. Screw the nut back onto the switch housing from the back of the control panel. Push the switch back into the switch housing.

7. Remove the "E"-ring and slide the shaft and the plastic ring off the joystick base. Be sure that the bushings remain in the base. Screw the base to the underside of the control panel. Slide the plastic ring around the shaft so that the rough side is next to the shaft handle. Slide the shaft through the control panel and base. Replace the "E"-ring.
8. Mount the volume control, using the screws provided, where it is easily accessible. On top of the cash box, or on the wall near the sound board are two possible locations.

Suggested control panel template layout

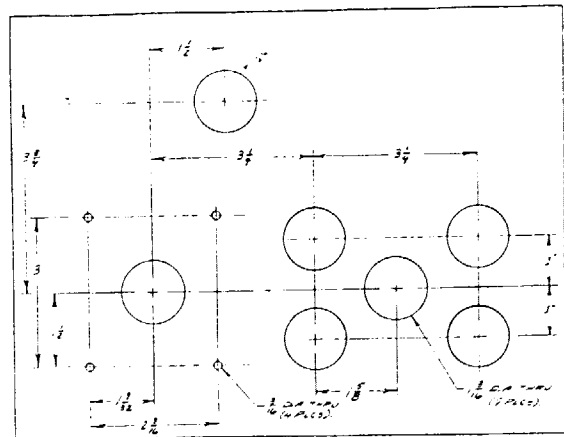
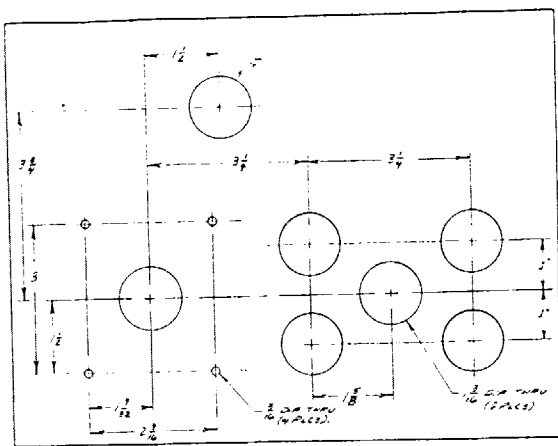

Suggested control panel layout and sticker locations for a typical video game control panel

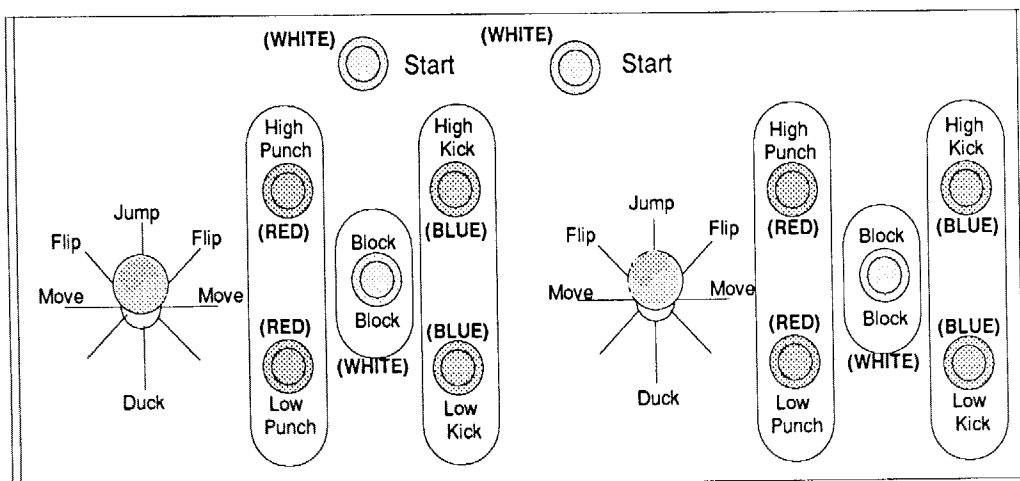

Installing the PC boards and wiring into a JAMMA game cabinet

Note

If you choose to use your own JAMMA Cable and not the one provided in the kit, be sure to check the JAMMA Cable Chart to verify that it is compatible.



CAUTION

Properly insulate any unused wires within the JAMMA cable, especially the gray, gray-green and gray-yellow wires. This is a fully wired JAMMA cable. Many of the wires will not be used for this kit. These wires have been installed so that you can use this cable for future kits

Note

The ribbon cable may need to be twisted in order to connect it properly.

1. Disconnect and remove the existing CPU board and sound board in the JAMMA game cabinet.
2. Mount the CPU board inside the JAMMA game cabinet where the old CPU board was located. Mount the sound board next to the CPU board using the stand-offs and screws provided.
3. If you choose to use the JAMMA cable provided with the kit, disconnect your old JAMMA cable from the speaker, power supply, control panel switches (may already be disconnected) and coin door. Remove the cable from the game. If you are not going to use the JAMMA Cable provided with the kit, check the JAMMA Cable Chart to be sure your cable is compatible. Leave your power supply chassis as is.
4. Connect the JAMMA cable to J1 on the CPU board. Use the Cabinet Wiring Diagram for reference and solder the correct JAMMA cable wires to the speaker. Then, connect the wires to the coin door, power supply and control panel.

Player 1 has orange-color stripe wires except for Start 1 which has a yellow-green wire. Player 2 has yellow-color stripe wires. Follow the Control Panel Wire Color List on the inside of the back cover or, the Cabinet Wiring Diagram in Section 3 of this book.
5. Connect the Auxiliary cable to J4 of the CPU board. Follow the Cabinet Wiring Diagram or the Control Panel Wire Color List and connect the wires to the switches for the Low Punch and Low Kick buttons for players 1 & 2.
6. Connect the ribbon cable from P1 on the sound board to J8 on the CPU board. Be sure that the red line goes to the same pin on both boards. Connect the wire harness cable from P7 (speaker), and P6 (power), on the sound board to J2 (sound power speaker connector) on the CPU board.
7. J6, J7, J9 on the CPU board are not used.
8. Place the FBI Warning Label on the inside of the cabinet next to the PC boards. Be sure the label is completely visible.

Installing the PC boards and wiring into a NON-JAMMA game cabinet

1. Disconnect and remove the existing CPU board and sound board in the game cabinet.
2. Mount the CPU board inside the game cabinet where the old CPU board was removed. Mount the sound board next to the CPU board using the stand-offs and screws provided.
3. Leaving several inches of wire, cut the wires at the coin door, control panel switches (which may already be disconnected) speaker and power supply. Remove the existing harness from the cabinet. Leave the cable hooks in place.
4. Install the JAMMA cable provided in this kit. Players 1 & 2, the coin door and the power supply wires are bundled together in individual groups. Insure that the cable is properly dressed and supported.
5. Connect the JAMMA cable to J1 on the CPU board. Use the Cabinet Wiring Diagram for reference and solder the correct JAMMA cable wires to the speaker. Then, connect the wires to the coin door, power supply and control panel.

Player 1 has orange-color stripe wires except for Start 1 which has a yellow-green wire. Player 2 has yellow-color stripe wires. Follow the Control Panel Wire Color List on the inside of the back cover or, the Cabinet Wiring Diagram in Section 3 of this book.
6. Connect the Auxiliary cable to J4 of the CPU board. Follow the Cabinet Wiring Diagram or the Control Panel Wire Color List and connect the wires to the switches for the Low Punch and Low Kick buttons for players 1 & 2.
7. Connect the ribbon cable from P1 on the sound board to J8 on the CPU board. Be sure that the red line goes to the same pin on both boards. Connect the wire harness cable from P7 (speaker), and P6 (power), on the sound board to J2 (sound power speaker connector) on the CPU board.
8. J6, J7, J9 on the CPU board are not used.
9. Place the FBI Warning Label on the inside of the cabinet next to the PC boards. Be sure the label is completely visible.

Note

Be sure all spliced wires are well insulated with black electrical tape.

CAUTION

Properly insulate any unused wires within the JAMMA cable, especially the gray, gray-green and gray-yellow wires. This is a fully wired JAMMA cable. Many of the wires will not be used for this kit. These wires have been installed so that you can use this cable for future kits

Note

The ribbon cable may need to be twisted in order to connect it properly.

GAME FEATURES

Note

When an error is detected during Start-up Tests, game start-up does not progress, and an error message appears on the screen.

STARTING UP

Switch on power to the game. A "rug" pattern appears on the CRT screen. When the "rug" pattern ends, the screen shows CHECKING SCRATCH RAMS, and then CHECKING ROMS. The next screen shows MORTAL KOMBAT REVISION LEVEL, CMOS TEST OK and the COIN SETTING. The game then begins the Attract Mode.

Insert the desired amount of coins or tokens. Press the appropriate Start button.

Player Controls

■ Start Buttons

Each player has a Start Button which allows him/her to begin or continue play.

■ High Kick/High Punch Buttons

Allows the screen player to kick or punch an opponent in the upper body.

■ Low Kick/Low Punch Buttons

Allows the screen player to kick or punch an opponent in the lower body.

■ Block Buttons

Allows the screen player to block an opponent's punch, kick or special move.

■ Joystick

Allows the screen player to move, flip, jump and duck.

Note

Discover secret moves by using joystick and button combinations.

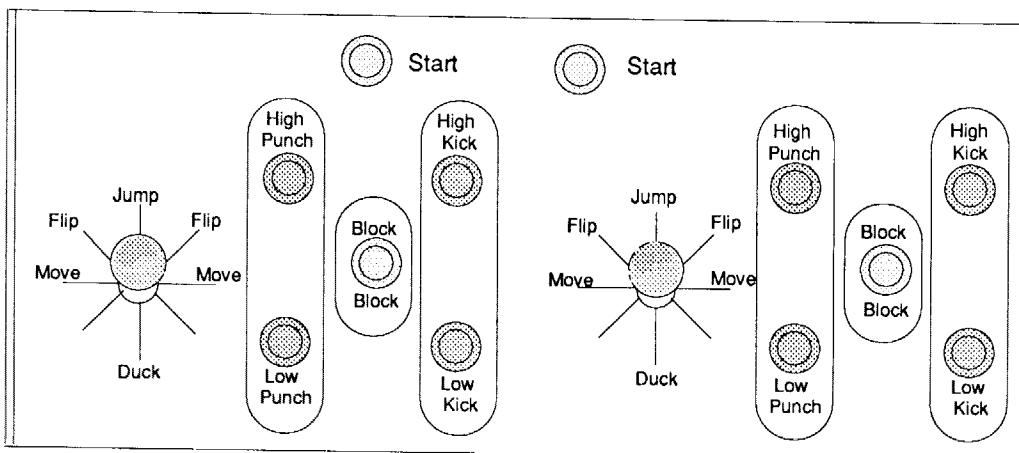

Control Panel

GAME OPERATION

It is suggested that the MORTAL KOMBAT Control Switches be located inside the coin door. These switches allow the operator to customize some features of the game.

CONTROL SWITCHES

- The **COIN DOOR SLAM TILT SWITCH** detects any forceful vibrations against the Coin Door. This eliminates pounding for free games. (Optional Switch.)
- The **VOLUME CONTROL** allows increasing or decreasing the volume level of the game music and speech. For greater profits, set your game's volume level at its maximum.
- The **TEST/DIAGNOSTICS SWITCH** allows you to activate the game's Menu System. Move the Test Switch to access the Main Menu. To exit the Menu System, select EXIT TO GAME OVER from the Main Menu, then press any control panel button. This function is also available on DIP Switch #2 position #8. (Optional Switch.)
- The **SERVICE CREDIT SWITCH** is a special feature switch that allots credit without affecting the game's bookkeeping total. (Optional Switch.)

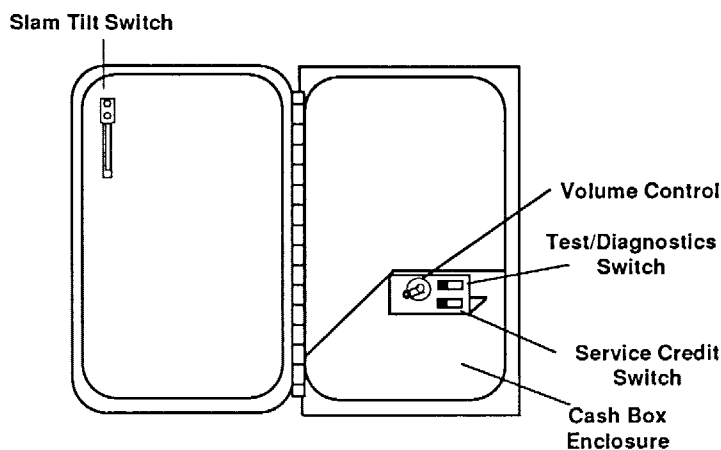

Typical Control Switch Locations

MENU SYSTEM OPERATION

OPERATION

All MORTAL KOMBAT Game Audits, Adjustments, and Diagnostics are options of the Main Menu. Each option, in turn, has its own menu, listing several choices that you may act upon as desired.

Move the Test Switch (if installed), or close Switch #8 of DIP Switch Bank #2, to activate the Main Menu (shown below). Game adjustments, bookkeeping, and diagnostics are all accessible from this menu.

Move any joystick up or down to cycle through the menu options. Notice that the options are highlighted in sequence. Press any button to activate a highlighted option.

Note: Only highlighted options can be activated.

**Select With Any Stick
Activate with Any Button**

**Diagnostic Tests
Coin Bookkeeping
Game Audits
Game Adjustment
Utilities
Exit Test Menu**

Main Menu

DIAGNOSTIC TESTS

To enter the Diagnostic Tests from the Main Menu, move any joystick to select (highlight) the Diagnostic Test option, and press any control panel button to activate the option.

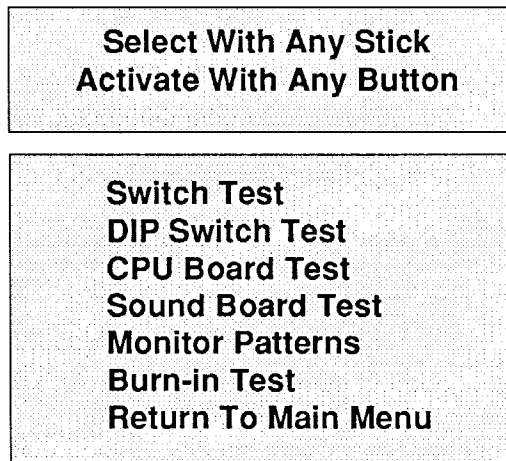

Diagnostic Menu

Switch Test

The Switch Test allows the operator to test the switches on the control panel and the coin door.

Select the Switch Test by using any joystick to highlight the Switch Test option; then, press any control panel button to activate it. The top of the screen shows a layout of the control panel and the bottom of the screen lists the coin door switches. Pressing a switch causes the corresponding switch location on the screen to light. Release the switch and the screen returns to normal.

Press the Start buttons together to return to the Diagnostic Menu.

DIP Switch Test

Note

Setting the positions of DIP Switch 1 to Off means there is violence, blood low blows, and attract mode sounds in the game.

The DIP Switch Test allows the operator to check the position of the two 8-position DIP Switches on the CPU Board. The operator can also change the setting of each position of each DIP Switch during this mode.

Use any joystick to select the DIP Switch Test and any control panel button to activate it. The screen displays a layout of their current settings.

To change a DIP Switch setting, press the switch to the desired setting, then check the screen to verify that the switch now shows the new setting.

Press any control panel button to return to the Diagnostic Menu.

DIP Switch 1 Settings Table

	SW 1	SW 2	SW 3	SW 4	SW 5	SW 6	SW 7	SW 8
Violence On	Off * On							
Blood in game		Off * On						
Low Blow in game			Off * On					
Attract Sounds On				Off * On				
Not Used					Off * On	Off * On	Off * On	Off * On

DIP Switch 2 Settings Table

	SW1	SW2	SW3	SW4	SW5	SW6	SW7	SW8
Coinage								
DIP Switch	Off *							
CMOS	On							
Coin Settings		Off *	Off *	Off *				
USA 1 Ger 1 Fr 1		On	Off	Off				
USA 2 Ger 2 Fr 2		Off	On	Off				
USA 3 Ger 3 Fr 3		On	On	Off				
USA 4 Ger 4 Fr 4		Off	Off	On				
USA ECA Ger ECA Fr ECA		On	Off	On				
N/U N/U N/U		Off	On	On				
N/U N/U N/U		Off	On	On				
Free Play Free Play Free Play		On	On	On				
Country					Off *	Off *		
USA					On	Off		
German					Off	On		
French					On	On		
Not Used								
One Counter							Off *	
Two Counters							On	
Test Switch								Off *
Game Mode								On
Test Mode								

* Indicates Factory Setting

CPU Board Test

The CPU Board Test (much like the Start-up Test) allows the operator to check the RAMs and ROMs.

Select the CPU Board Test with any joystick; then, press any control panel button to activate the automatic test of the CPU Board's RAMs and ROMs. When this test is activated, a "rug" pattern appears on the screen. The screen then changes to show the layout of the RAMs, and ROMs. A ROM or RAM location that is shown as black with a white outline is used and should turn either red or green. A ROM or RAM location that is shown as gray with a white outline is not used in this game. During the test, ROM or RAMs are good, if they turn green; they are faulty, if they turn red.

The CPU Test pauses when a bad ROM or RAM is detected. Press any button to continue the test.

Sound Board Test

The Sound Test allows listening to some of the sounds that this game is capable of producing. This test also emits a tone for each fault that is detected.

Select the Sound Board Test with any joystick; then, press any control panel button to activate the test. The screen displays two test options:

GENERAL TEST analyzes the sound circuitry. The screen shows a list of error codes. A successful test causes a single "tone" to sound. Detection of a fault causes a series of tones or no tone at all to sound.

PLAY SOUNDS tests synthesized & digitized sounds from the Sound Board. Advance to the next sound by moving any joystick, and press any control panel button to activate the sound.

Select RETURN TO MAIN MENU or BACK TO DIAGNOSTIC MENU. Press any control panel button to activate your selection.

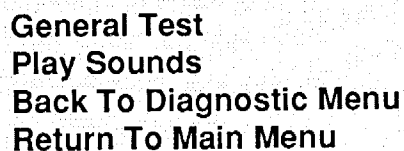

General Test
Play Sounds
Back To Diagnostic Menu
Return To Main Menu

Sound Test Menu

Monitor Patterns

The Monitor Patterns Test provides a menu for testing the monitor. Select the test with any joystick and activate with any control panel button. Once the Monitor Patterns Test is activated, move any joystick to select a test option; press any control panel button to activate the option. Press any control panel button again to return to the Monitor Patterns Test menu.

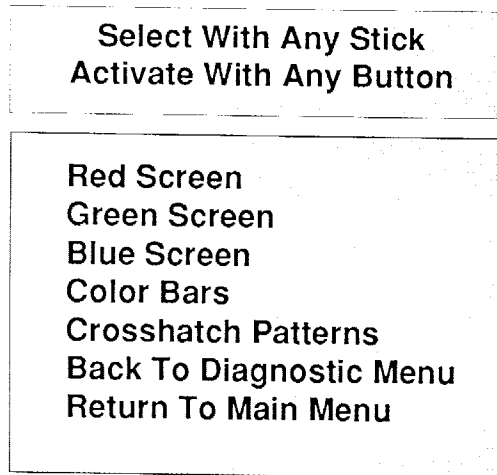

Monitor Pattern Menu

The **RED**, **GREEN**, and **BLUE SCREEN** tests fill the screen with either red, green or blue.

The **COLOR BARS** test fills the screen with several shades of colors to help with red, green and, blue level adjustments. Each color should appear sharp and clear.

The **CROSSHATCH PATTERNS** test fills the screen with a grid and a series of dots. The grid and the dots should be clear. The dots should appear round.

If any of the Monitor Pattern Tests shows a need for adjustment, use the proper white knobs on the Monitor Board.

Use any joystick to select **RETURN TO MAIN MENU** or **BACK TO DIAGNOASTIC MENU** and activate with any control panel button.

Burn-in Test

The Burn-in Test continually repeats the CPU Board Test. Move any joystick to select the Burn-in Test; then, press any control panel button to activate the test. When the Burn-in Test detects an error, the test stops and displays an error message on the screen. The second page of the Audit Table specifies the number of Burn-in cycles successfully completed. Use this test to find intermittent CPU problems.

To exit this test, switch the game Off then On again.

COIN BOOKKEEPING

To enter the Coin Bookkeeping from the Main Menu, move any joystick to select the Coin Bookkeeping option; then, press any control panel button to activate it.

The Coin Bookkeeping Table records the coinbox totals and game play counters. The left side of the table names the bookkeeping item; the right side shows the number of coins, credits, or plays for each item.

To exit Coin Bookkeeping, move any joystick to select RETURN TO MAIN MENU; then, press any control panel button to activate it.

Left Slot Coins	0
Right Slot Coins	0
Third Slot Coins	0
Fourth Slot Coins	0
Service Credits	0
Paid Credits	0
Total Plays	0

More Detailed Data
Return To Main Menu

Coin Bookkeeping Table

Left Slot Coins	0
Right Slot Coins	0
Third Slot Coins	0
Fourth Slot Coins	0
Total Collections	0

Clear Coin Meters
Return To Main Menu

Total Collection Table

GAME AUDITS

To enter Game Audits from the Main Menu, move any joystick to select the Game Audits option; then, press any control panel button to activate it. To advance to the next (or return to the previous) page of the Game Audit Table, move any joystick to select either "Next Audit Page", or "Previous Audit Page"; then, press any control panel button to change the page.

The Game Audits Table records the game play statistics. The left side of the table names the Audit item; the right side shows the amount of play.

Hours Game was On	0
Hours Played with 1 Player	0
Hours Played with 2 Players	0
Total Plays	0
1 Player Continues Taken	0
2 Player Continues Taken	0
Highest Battle Reached	0
Winning Streak Reset Count	0
Burn-in Loops Successfully Completed	0

Next Audit Page
Return To Main Menu

Page 1 of Audit Table

Cage Chosen	0
Kans Chosen	0
Raiden Chosen	0
Liu Kang Chosen	0
Sub-zero Chosen	0
Scorpion Chosen	0
Sonya Chosen	0
Error Traps	0

Previous Audit Page
Return To Main Menu

Page 2 of Audit Table

To exit the Game Audit Table, move any joystick to select RETURN TO MAIN MENU; then, press any control panel button to activate your selection.

GAME ADJUSTMENTS

Move any joystick to select the Game Adjustment option on the Main Menu; then, press any control panel button to activate it.

The Game Adjustments Menu allows the owner/operator to change the Game Pricing and Game Difficulty.

The Game Adjustments Menu offers several options. Each option has several choices. Move any joystick to select an option; then, press any control panel button to activate that option. The next menu screen provides a setting choice. Move any joystick to modify the setting value; then, press any control panel button to lock in the new value and return to the Adjustment Menu. Move the joystick up to increase the setting value, move the joystick down decrease the setting value.

To exit the Adjustments Menu, use any joystick to select RETURN TO MAIN MENU; then, use any control panel button to activate your selection.

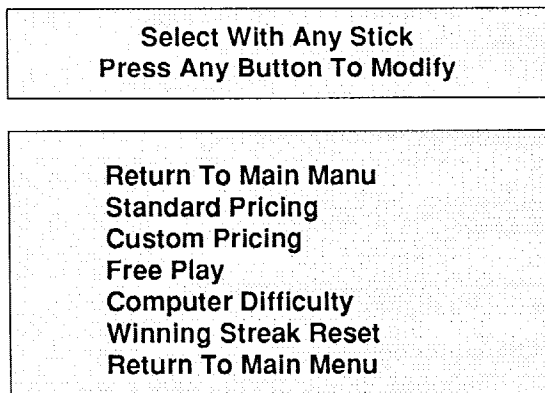

Game Adjustment Menu

Note

Game Adjustments are explained in more detail on the following page.

Adjustment values set by DIP Switch, override adjustment values set by the menu system.

Game Adjustments

Standard Pricing

Standard Pricing allows the operator to choose any of the "Standard" selections for the Standard Pricing Table. See page 1-21.

Modify the setting value with any joystick. Press any control panel button to lock in the new value and return to the Adjustment Menu.

Custom Pricing

Custom Pricing allows the operator to install pricing other than that of the Standard Pricing Table. Custom Pricing also allows the operator to select the maximum amount of credits per game, the amount of credits required to start a game, and the amount or credits required to continue a game. This option is being adjusted from the Dip Switch Settings. See page 1-22.

Modify the setting value with any joystick. Press any control panel button to lock in a new value and return to the Adjustment Menu.

Free Play

This option selects free play. The setting choices for this adjustment are:

- No (factory)
- Yes

Computer Difficulty

This option determines the difficulty level of game play. The setting choices for this adjustment are:

- 1 (Extra Easy)
- 2 (Easy)
- 3 (Medium; factory)
- 4 (Hard)
- 5 (Extra Hard)

Winning Streak Reset

This option resets the highest scores after a selected amount of games are played. The setting choices for this adjustment are:

- Reset every 5,000 games.
- Reset every 10, 000 games (factory).
- Reset every 15, 000 games.
- Do Not Reset.

Standard Pricing Table

Name	Settings Credit/Coin	Left Chute	Center Chute	Right Chute	Fourth Chute
USA 1	1/25¢ (2 to Start; 2 to Continue)	25¢		25¢	
USA 2	1/25¢ (2 to Start; 1 to Continue)	25¢		25¢	
USA 3	1/25¢ (1 to Start; 1 to Continue)	25¢		25¢	
USA 4	1/50¢, 3/\$1.00 (1 to Start; 1 to Continue)	25¢		25¢	
USA 5	1/50¢, 4/\$1.00 (2 to Start; 1 to Continue)	25¢		25¢	
USA 6	1/50¢ (1 to Start; 1 to Continue)	25¢		25¢	
USA 7	1/50¢, 3/\$1.00 (1 to Start; 1 to Continue)	25¢	\$1.00	25¢	
USA 8	1/50¢, 4/\$1.00 (1 to Start; 1 to Continue)	25¢		25¢	
USA ECA	1/25¢, 4/\$1.00 (2 to Start; 2 to Continue)	\$1.00	10¢	25¢	5¢
German 1	1/1DM, 6/5DM	1 DM		5 DM	
German 2	1/1DM, 7/5DM	1 DM		5 DM	
German 3	1/1DM, 8/5DM	1 DM		5 DM	
German 4	1/1DM, 5/5DM	1 DM		5 DM	
German 5	1/1DM, 6/5DM	1DM		5DM	
German ECA	1/1DM, 2/2DM, 6/5DM	5DM	1DM	2DM	
France 1	2/5F, 5/10F	5 F		10 F	
France 2	2/5F, 4/10F	5 F		10 F	
France 3	1/5F, 3/10F	5 F		10 F	
France 4	1/5F, 2/10F	5 F		10 F	
France 5	2/5F, 5/10F, 11/2 x 10F	5F		10F	
France 6	2/5F, 4/10F, 9/2 x 10F	5F		10F	
France 7	1/5F, 3/10F, 7/2 x 10F	5F		10F	
France 8	1/5F, 2/10F, 5/2 x 10F	5F		10F	
France 9	1/3 x 1F, 2/5F	1F		5F	
France 10	1/2 x 1F, 3/5F	1F		5F	
France 11	1/3 x 1F, 2/5F, 5/2 x 5F	1F		5F	
France 12	1/2 x 1F, 3/5F, 7/2 x 5F	1F		5F	
France ECA	1/3 X 1F, 2/5F, 5/2 X 5F	1F	10F	5F	
Canada	1/2 x 25¢, 3/\$1.00	25¢		\$1.00	
Swiss 1	1/1F, 6/5F	1F		5F	
Swiss 2	1/1F, 7/5F	1F		5F	
Swiss 3	1/1F, 8/5F	1F		5F	
Italy	1/500 lire	500 lire		500 lire	
UK 1	1/20P, 3/50P	20P		50P	
UK 2	2/20P, 5/50P	20P		50P	
UK ECA	1/20P, 3/50 P, 7/£1.00	£1.00	20P	50P	10 P
UK Elec w/CCU	1/30P, 2/50P, 4/£1.00	£1.00		CCU	
Spain 1	1/100 peseta, 6/500 peseta	100 peseta		500 peseta	
Spain 2	1/100 peseta, 5/500 peseta	100 peseta		500 peseta	
Australia 1	1/3 x 20¢, 2/\$1.00	20¢		\$1.00	
Australia 2	1/5 x 20¢, 1/\$1.00, 3/20¢	20¢		\$1.00	
Japan 1	1/100 yen	100 yen		100 yen	
Japan 2	2/100 yen	100 yen		100 yen	
Austria 1	1/5 schilling, 2/10 schilling	5 schilling		10 schilling	
Austria 2	1/2 x 5 schilling, 3/2 x 10 schilling	5 schilling		10 schilling	
Belgium 1	1/20F	20F		20F	
Belgium 2	3/20F	20F		20F	
Belgium 3	2/20F	20F		20F	
Belgium ECA	1/25¢, 4/\$1.00	50F	5F	20F	
Sweden	1/3 x 1 krona, 2/ krona	1 krona		5 krona	
New Zealand 1	1/3 x 20¢	20¢		20¢	
New Zealand 2	1/2 x 20¢	20¢		20¢	
Netherlands	1/1HFI, 3/2.5HFI	1HFI		2.5HFI	
Finland	1/1 markka	1 markka		1 markka	
Norway	1/2 x 1 krone, 3/5 x 1 krone	1 krone		1 krone	
Denmark	1/2 x 1 krone, 3/5 krone, 7/2 x 5 krone	1 krone		5 krone	
Antillies	1/25¢, 4/1 guilder	25¢		1 guilder	
Hungary	1/2 x 10 forint, 3/2 x 20 forint	10 forint		20 forint	

If option desired is not shown above, use Custom pricing.

Custom Pricing

Select With Any Stick
Press Any Button To Modify

Return To Adj. Menu
(1) Left Chute Units
(1) Right Chute Units
(1) Third Chute Units
(1) Fourth Chute Units
(2) Units/Credits
(3) Units/Bonus
(4) Minimum Units Required
(5) Credits To Start
(6) Credits To Continue
(7) Coins Per Dollar
Maximum Credits
Return To Adj. Menu

- (1) Coins inserted accumulate units. This adjustment specifies the number of units given for each coin in the fourth chute (see "units/credit").
- (2) This is the number of coin units required to buy one credit.
- (3) One bonus credit is awarded after this many coin units have accumulated.
- (4) No credits will be awarded until this many coin units have accumulated.
- (5) Each player needs this many credits to begin a game.
- (6) Each player needs this many credits to continue a game.
- (7) The detailed bookkeeping screen shows total collections based on this many coins per dollar. (Set to zero to disable the display of money totals)
- (8) This is the limit for the credits counter. Additional coins inserted will be lost (factory setting: 30)

UTILITIES

Move any joystick to select the Utilities option on the Main Menu; then, press any control panel button to activate it.

The Utilities Menu allows the owner/operator to clear the game's bookkeeping memory and to install a custom message.

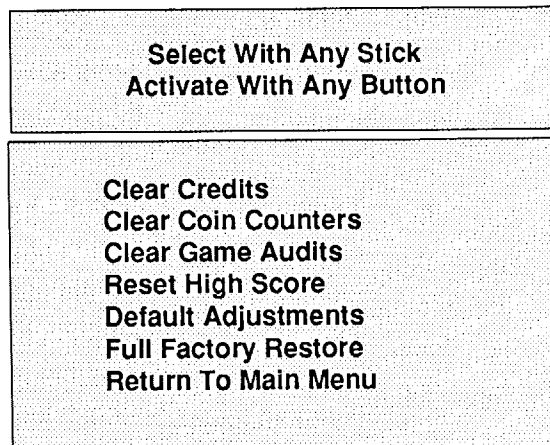

Utilities Menu

Move any joystick to select an item from the Utilities Menu; then, press any control panel button to activate that item. After an item has been activated, you are given the option of resetting that item or not. For example,

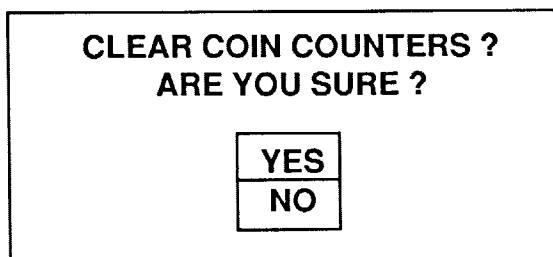

Move any joystick to choose YES or NO; then, press any control panel button to lock in your choice and to return to the Utilities Menu.

To exit the Utilities Menu, move any joystick to select RETURN TO MAIN MENU; then press any control panel button to activate your selection.

TROUBLESHOOTING

Problem	Possible Solution
No Picture or Distorted Picture.	Check for faulty video board or monitor. Check for disconnected video signal cable.
Turn game On and nothing happens.	Check line fuse. Check for +5Vdc at pins C, D, 3, and 4 of the JAMMA Connector.
No sound.	Check the speaker and speaker connection to pins L and 10 on the JAMMA Connector. Check volume control setting. Check for +12V dc at pins F and 6 on the JAMMA Connector. Check interboard wiring from CPU Board to the Sound Board.
No General Illumination.	Check the 1A., S.B. fuse.
Move joystick and the screen player does not move.	Check for open wires between the joystick and CPU Board. Check for contamination on joystick switch contacts and CPU Board pins. Check for proper ground.
Press Start Button and nothing happens.	Check for open wires between the button and CPU Board. Check for contamination on CPU Board pins or the button switch blade contacts. Check for proper ground.
Press any control panel button and screen player does not move.	Check for open wires between the button and CPU Board. Check for contamination on CPU Board pins or the button switch blade contacts. Check for proper ground.
No credit given when coins are inserted.	Check DIP switch coin setting. Check for contamination on coin switch contacts. Check for an open wire between Coin Switch 1 and pin 16 on the JAMMA Connector or Coin Switch 2 and pin T of the JAMMA Connector.
Too many credits for number of coins inserted.	Check Game Pricing setting. Check for a short between pins T & 16 on the JAMMA Connector.
Game stays in test mode.	Check that the Test Switch in the coin door is set to Off.

MORTAL KOMBAT

S E C T I O N
two

PC Board Parts

A-13234-40025 CPU Board Assembly

INDICATES
REVISED PIN

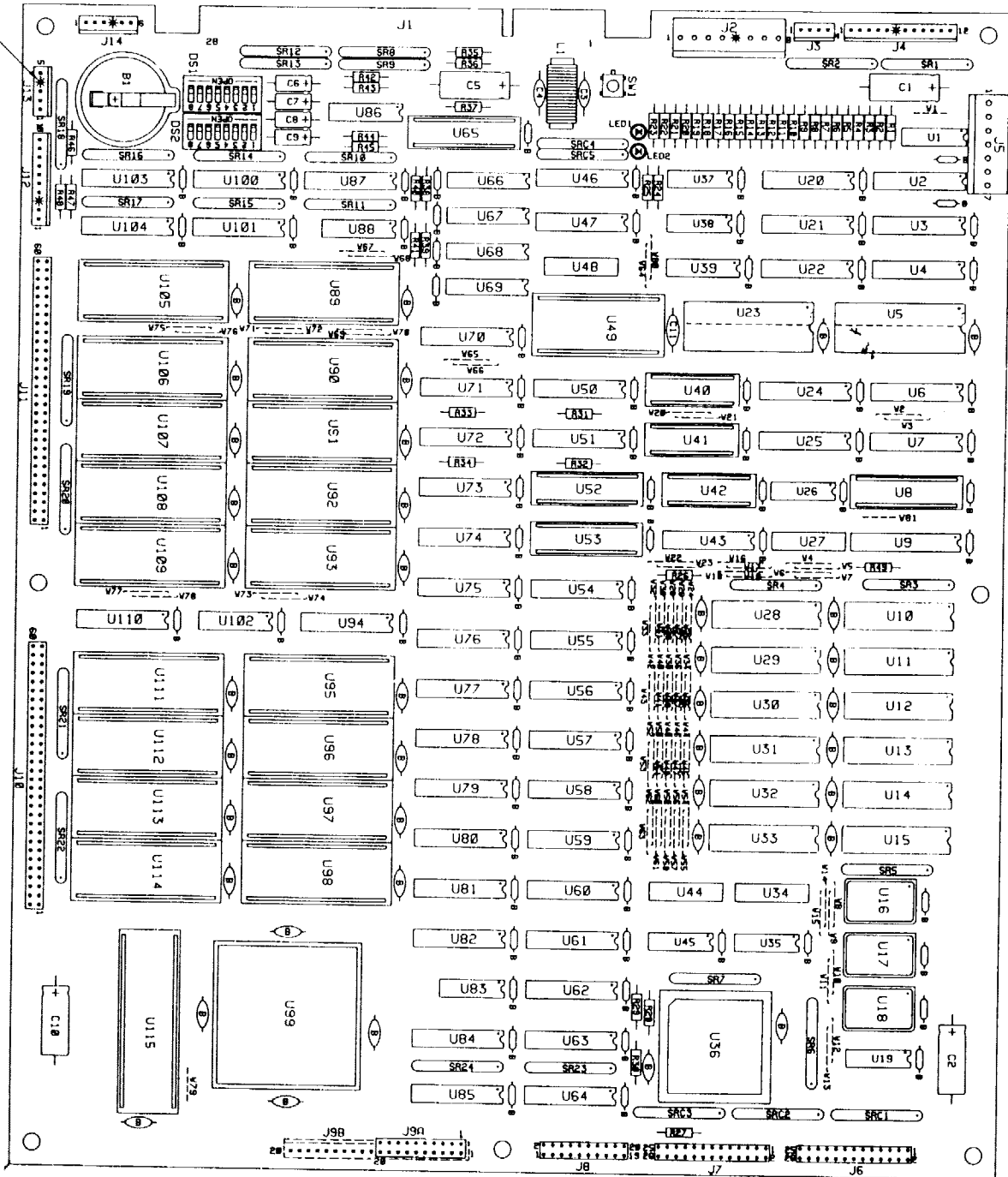

A-13234-40025 CPU Board Parts

Part Number	Designator	Description	Part Number	Designator	Description
5281-09737-00	U1	IC, 74LS86	5671-09019-00	LED1, LED2	LED, Red
5317-12211-00	U2, U20, U24, U43, U61, U62, U70	IC, 74ALS541	5551-09822-00	L1	Inductor, 4.7μH
5317-12212-00	U3, U6, U7, U21, U25, U50, U58, U63, U64, U71, U72, U74, U79, U84, U85	IC, 74ALS574	5645-09025-00	DS1, DS2	DIP Switch 16-pin
5317-12208-00	U4, U22, U54-U57, U59, U60, U75-U78, U80, U81, U94, U110	IC, 74ALS245	5641-12551-00	SW1	Pushbutton Switch
5340-12840-00	U5, U23	IC, 8K x 8 Static RAM	5881-12315-00	B1	Battery Holder
5700-12047-00	U8, U52, U53, U65	24-pin Socket	5791-10862-08	J2	8-pin Connector
5521-10421-00	U16	48Mhz Xtal	5791-12461-12	J4	12-pin Connector
5521-10318-00	U17	24Mhz Xtal	5791-10850-00	J6, J7	26-pin Ribbon Connector
5283-10468-00	U19, U45	IC, 74F74	5791-09437-00	J8	20-pin Ribbon Connector
5019-10849-00	U27, U34, U44, U48	100Ω DIP Res.	5791-12461-10	J12	10-pin Connector
5286-13209-00	U35	IC, 74AS00	5700-12252-00	U12-U15	24-pin Socket
5700-12253-00	U36	68-pin Socket	5791-12461-05	J13	5-pin Connector
5280-09309-00	U37	IC, 7407	5791-12461-04	J3	4-pin Connector
5281-09487-00	U38	IC, 74LS74	5791-12461-20	J9A, J9B	20-pin Connector
5434-12255-00	U39	MAX691	5791-12461-04	J14	6-pin Connector
5700-09915-00	U40, U41, U42	20-pin Socket	5880-11056-00	B1	Lithium Battery, 3A
5311-12287-00	U46, U47, U87, U100 U101, U103, U104	IC, 74HC541	03-8338-1		1/4" Spacer
5700-10176-00	U49	28-pin Socket	A-5346-40025-1	U8	IC, PLD Color RAM Control
5311-12285-00	U51, U73, U82	IC, 74HC573	5400-12220-00	U36	IC, TMS34010, 50 GSP
5340-12014-00	U66-U69	IC, 4464 DRAM, 64 x 4	A-5346-40025-2	U40	IC, PLD Address Decode
5283-10552-00	U83	IC, 74F04	A-5346-40025-3	U41	IC, PLD Video RAM Control
5370-12602-00	U86	IC, ULN2064B	A-5346-40025-4	U42	IC, PLD Local Control
5317-12023-00	U88	IC, 74ALS138	5340-12558-00	U49	IC, 8K x 8 Static RAM, 150ns
5700-12088-00	U89-U93, U95-U98, U105-U109, U111-U114	32-pin Socket	A-5346-40025-5	U52	IC, PLD Video RAM Sequencer
5700-12254-00	U99	114-pin Socket	A-5346-40025-6	U53	IC, PLD Image ROM Control
5317-12024-00	U102	IC, 74ALS139	A-5346-40025-7	U65	IC, PLD Miscellaneous Control
5700-08985-00	U115	40-pin Socket	A-5343-40025-1	U89	IC, Game EPROM
5010-08991-00	R1, R24, R27	4.7KΩ Res., 5%, 1/4W	A-5343-40025-10	U105	IC, Game EPROM
5010-10204-00	R2, R7, R12	1KΩ Res., 2%, 1/4W	A-5346-40025-8	U115	IC, PLD Autoerase Controller
5010-10205-00	R3, R8, R13	2KΩ Res., 2%, 1/4W	5410-12239-00	U99	IC, Custom ASIC
5010-10000-00	R4, R9, R14	3.9KΩ Res., 5%, 1/4W	5340-12213-00	U10-U15, U28-U33	IC, VRAM 64K x 4, 150ns
5010-09219-00	R5, R10, R15	8.2KΩ Res., 5%, 1/4W	5341-13297-00	U111	IC, ROM
5010-08772-00	R6, R11, R16	15KΩ Res., 5%, 1/4W	5341-13297-01	U95	IC, ROM
5010-09001-00	R23, R25	330Ω Res., 5%, 1/4W	5341-13297-02	U106	IC, ROM
5010-09036-00	R26, R29-R34, R50 R51	100Ω Res., 5%, 1/4W	5341-13297-03	U112	IC, ROM
5010-09416-00	R35-R37, R46-R48	470Ω Res., 5%, 1/4W	5341-13297-04	U96	IC, ROM
5010-08997-00	R38-R45	2.7KΩ Res., 5%, 1/4W	5341-13297-05	U107	IC, ROM
5010-09534-00	W2, W8, W11, W12, W14, W21, W22, W24, W27, W29, W30, W32, W34, W36, W39, W41, W42, W45, W47, W48, W50, W52, W55, W57, W58, W60, W62, W65, W68, W69, W71, W73, W75, W77, W80	0Ω Res., 1/4W	5341-13297-06	U113	IC, ROM
5043-08980-00	B	.01μf Cap., 10V, Axial	5341-13297-07	U97	IC, ROM
5040-08986-00	C1, C2, C5, C10	100μf Cap., 10V, Axial	5341-13297-08	U108	IC, ROM
5043-09845-00	C3, C4	.001μf Cap., 10V, Axial	5341-13297-09	U114	IC, ROM
5041-09243-00	C6-C9	10μf Cap., 10V, Axial	5341-13297-10	U98	IC, ROM
5043-08996-00	C11	.1μf Cap, Axial	5341-13297-11	U109	IC, ROM
5019-12611-00	SR1, SR3, SR8, SR9, SR12, SR13, SR18	470Ω SIP, 5 Res.			
5019-09362-00	SR3, SR4, SR6, SR7, SR11, SR15, SR17, SR19, SR20, SR21, SR22, SR23, SR24, SRC1, SRC2, SRC3	4.7KΩ SIP, 9 Res.			
5019-10143-00	SR5	470Ω SIP, 9 Res			
5060-10396-00	SRC4, SRC5, SRC10, SRC14, SRC16	4.7KΩ SIP, 470pf			

A-14732-40025 Sound Board Assembly

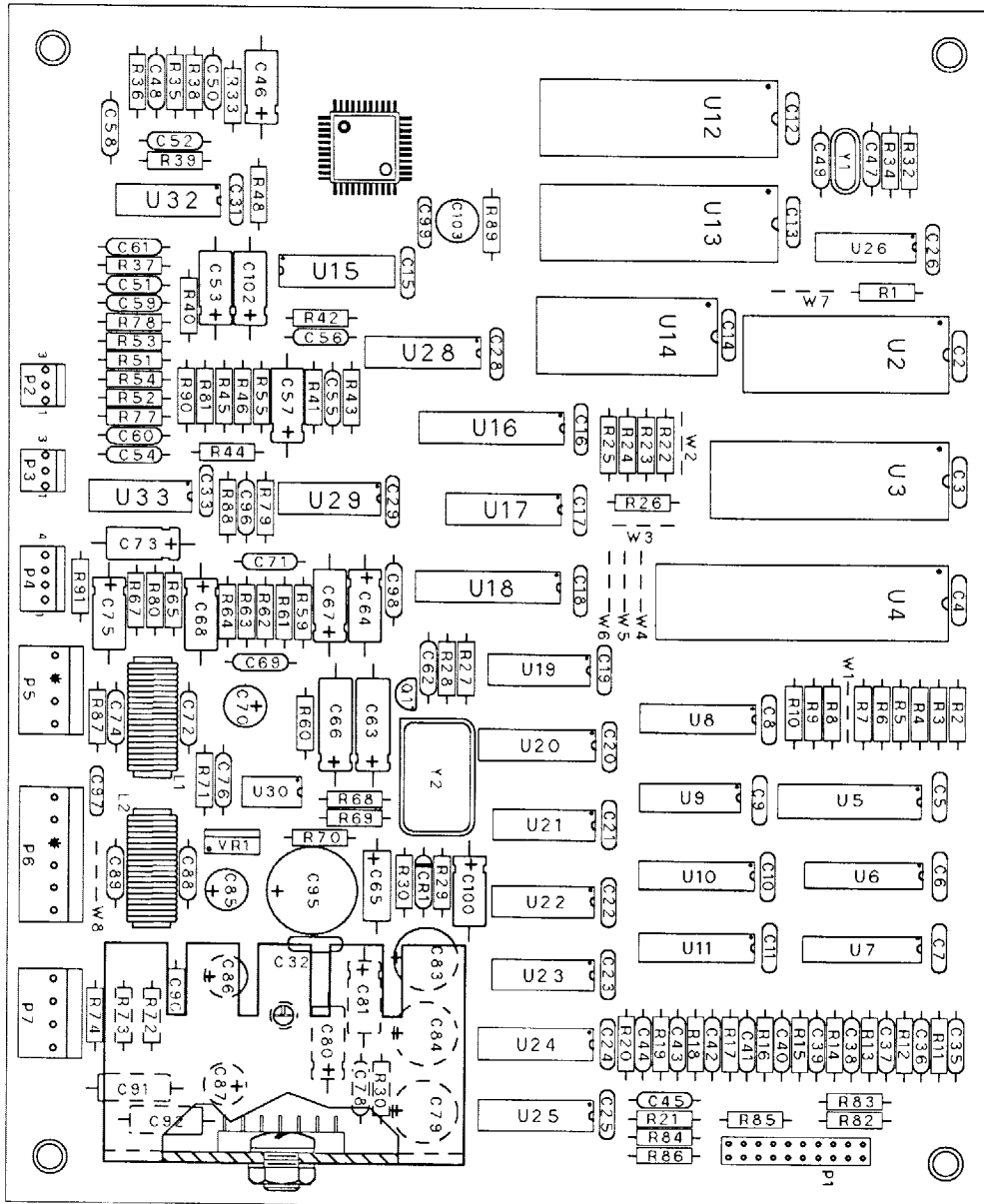

A-14732-40025 Sound Board Parts

Part Number	Designator	Description	Part Number	Designator	Description
5340-12958-00	U7, U11, U24	IC, 26LS31	5040-09421-00	C70, C85-C87, C103	100µf Cap., 25V
5340-12959-00	U6, U10, U25	IC, 26LS32	5040-09506-00	C79, C83, C84	220µf Cap., 16V
5281-09850-00	U19	IC, 74LS11	5040-12670-00	C95	2200µf Cap., 16V
5281-09215-00	U26	IC, 74LS04	5070-08919-00	CR1	1N4148 Diode
5281-09851-00	U21	IC, 74LS14	5160-12891-00	Q1	MPS3646 Trans.
5281-09487-00	U9, U22, U23	IC, 74LS74	5551-09822-00	L1, L2	4.7µH Inductor, 3A
5281-09745-00	U8	IC, 24LS138	5700-09006-00	U28	16-pin Socket
5281-09246-00	U20	IC, 74LS139	5700-09915-00	U18	20-pin Socket
5281-09733-00	U17	IC, 74LS174	5700-09004-00	U14	24-pin Socket
5281-09486-00	U5, U16	IC, 74LS374	5700-08985-00	U4	40-pin Socket
5340-12278-00	U2	IC, Static RAM, 8K x 8	5700-12088-00	U3, U12, U13	32-pin Socket
5370-12260-00	U30	IC, 3340 Attenuator	5791-10862-04	P5, P7	4-pin Header
5460-12743-00	VR1	IC, 7809 Regulator, +9V	5791-10862-06	P6	6-pin Header
5370-12960-00	U29	IC, LM324 Op Amp	5791-09437-00	P1	20-pin Header
5370-12730-00	U32, U33	IC, TL084 Op Amp	01-10516		Heat Sink
5371-12727-00	U15	AD7524 DAC	4406-01128-00		6-32 Hex Nut
5370-12963-00	U31	HA13116 Pwr. Amp	4006-01003-06		6-32 x 3/8 P-PH-S
5521-10931-00	Y2	8Mhz Oscillator	20-9690-18		Spacer, 1-1/8
5520-09020-00	Y1	3.58 Mhz Crystal	A-5343-40025-19	U3	IC, EPROM
5010-09534-00	W2, W3, W5, W7, W8	0Ω Resistor	5400-10320-00	U4	IC, 68B09E, MPU
5010-12961-00	R72-R74	3.3Ω Res., 5%, 1/2W	A-5343-40025-20	U12	IC, EPROM
5010-09039-00	R89	10Ω Res., 5%, 1/4W	A-5343-40025-21	U13	IC, EPROM
5010-10170-00	R11-R21	47Ω Res., 5%, 1/4W	5370-11086-00	U14	IC, YM2151 Sound Generator
5010-09036-00	R4, R30, R90	100Ω Res., 5%, 1/4W	A-5346-40025-9	U18	IC, PLD Sound
5010-09187-00	R27	150Ω Res., 5%, 1/4W	5371-11087-00	U28	IC, YM3012 DAC
5010-09160-00	R83	220Ω Res., 5%, 1/4W	5433-12962-00	U1	IC, OKI6295, 4 Channel
5010-09416-00	R32, R43, R41, R82	470Ω Res., 5%, 1/4W	03-8338-1		Mtg. Spacer, 1/4"
5010-09358-00	R43, R68	1KΩ Res., 5%, 1/4W			
5010-08998-00	R22-R24, R26, R59, R61	2.2KΩ Res., 5%, 1/4W			
5010-08983-00	R28	3.3KΩ Res., 5%, 1/4W			
5010-10000-00	R87	3.9KΩ Res., 5%, 1/4W			
5010-08991-00	R1-R3, R5-R10, R25, R84-R86, R91	4.7KΩ Res., 5%, 1/4W			
5010-09219-00	R69	8.2KΩ Res., 5%, 1/4W			
5010-09034-00	R62, R63, R67, R70, R80	10KΩ Res., 5%, 1/4W			
5010-09269-00	R64	12KΩ Res., 5%, 1/4W			
5010-09324-00	R68	27KΩ Res., 5%, 1/4W			
5010-09325-00	R36	39KΩ Res., 5%, 1/4W			
5010-09035-00	R29, R53, R81	47KΩ Res., 5%, 1/4W			
5010-10987-00	R77, R78	56KΩ Res., 5%, 1/4W			
5010-10650-00	R38, R45, R51	62KΩ Res., 5%, 1/4W			
5010-08776-00	R31, R71	68KΩ Res., 5%, 1/4W			
5010-10257-00	R35	75KΩ Res., 5%, 1/4W			
5010-12927-00	R79	82KΩ Res., 5%, 1/4W			
5010-09162-00	R33, R48, R54, R55, R60, R65	100KΩ Res., 5%, 1/4W			
5010-12965-00	R39	130KΩ Res., 5%, 1/4W			
5010-09134-00	R40, R44, R46, R52	150KΩ Res., 5%, 1/4W			
5010-12964-00	R37, R42	820KΩ Res., 5%, 1/4W			
5048-11027-00	C59, C60	33pf Cap., 10%			
5043-10264-00	C50, C62	68pf Cap., 10%			
5043-09492-00	C35-C45, C47, C49, C98	100pf Cap., 10%			
5048-12748-00	C54, C61, C96	220pf Cap., 10%			
5048-11030-00	C71	470pf Cap., 10%			
5048-12506-00	C78	820pf Cap., 10%			
5048-11031-00	C48, C55, C76	1000pf Cap., 10%			
5048-11065-00	C69	2200pf Cap., 10%			
5048-12967-00	C58	2700pf Cap., 10%			
5048-11072-00	C51, C56	3300pf Cap., 10%			
5048-12966-00	C52	3900pf Cap., 10%			
5043-08980-00	C2-C26, C28, C29, C31-C33, C97, C99	.01µf Cap., 10%			
5045-12926-00	C90-C92	.1µf Cap., 10%			
5043-08996-00	C72, C74, C88, C89	.1µf Cap., 20%			
5048-12036-00	C65	.22µf Cap., 10%			
5040-09365-00	C68	1µf Cap.,			
5040-09343-00	C46, C53, C57, C64, C67, C73, C75, C81, C100, C102	10µf Cap., 16V, 20%			
5040-09332-00	C63, C66, C80	47µf Cap., 25V			

MORTAL KOMBAT

S E C T I O N three

Schematics and Wiring Diagrams

JAMMA Chart

Function	Wire Color	Pin	Pin	Wire Color	Function
Ground	Black	1	A	Black	Ground
Ground	Green-Brown	2	B	Black	Ground
+5 Volts DC	Gray	3	C	Gray	+5 Volts DC
+5 Volts DC	Gray	4	D	Gray	+5 Volts DC
-5 Volts DC	Gray-Green	5	E	Gray-Green	-5 Volts DC
+12 Volts DC	Gray-Yellow	6	F	Gray-Yellow	+12 Volts DC
	Key	7	H	Key	
Counter 1 *	White-Orange	8	J	White-Green	Counter 2 *
	N/C	9	K	N/C	
Speaker (+)	Red-Violet	10	L	Green-Violet	Speaker (-)
	N/C	11	M	N/C	
Video Red	Red	12	N	Green	Video Grn
Video Blue	Brown	13	P	White	Video Sync
Video Grd	Shield	14	R	White-Red	Service Credit *
Test *	Green	15	S	White-Violet	Siam Tilt *
1 Coin	White-Blue	16	T	Yellow-White	2 Coin
1 Start	Yellow-Green	17	U	Yellow-Blue	2 Start
1 Up	Orange-Black	18	V	Yellow-Black	2 Up
1 Down	Orange-Brown	19	W	Yellow-Brown	2 Down
1 Left	Orange-Red	20	X	Yellow-Red	2 Left
1 Right	Orange	21	Y	Yellow-Orange	2 Right
1 High Punch	Orange-Yellow	22	Z	Yellow-Violet	2 High Punch
1 Block	Orange-Green	23	a	Yellow-Gray	2 Block
1 High Kick	Orange-Blue	24	b	Violet-Black	2 High Kick
N/C	N/C	25	c	N/C	N/C
N/C	N/C	26	d	N/C	N/C
Ground	N/C	27	e	N/C	Ground
Ground	Black	28	f	Black	Ground

* Optional Switches

Interboard Wiring Diagram

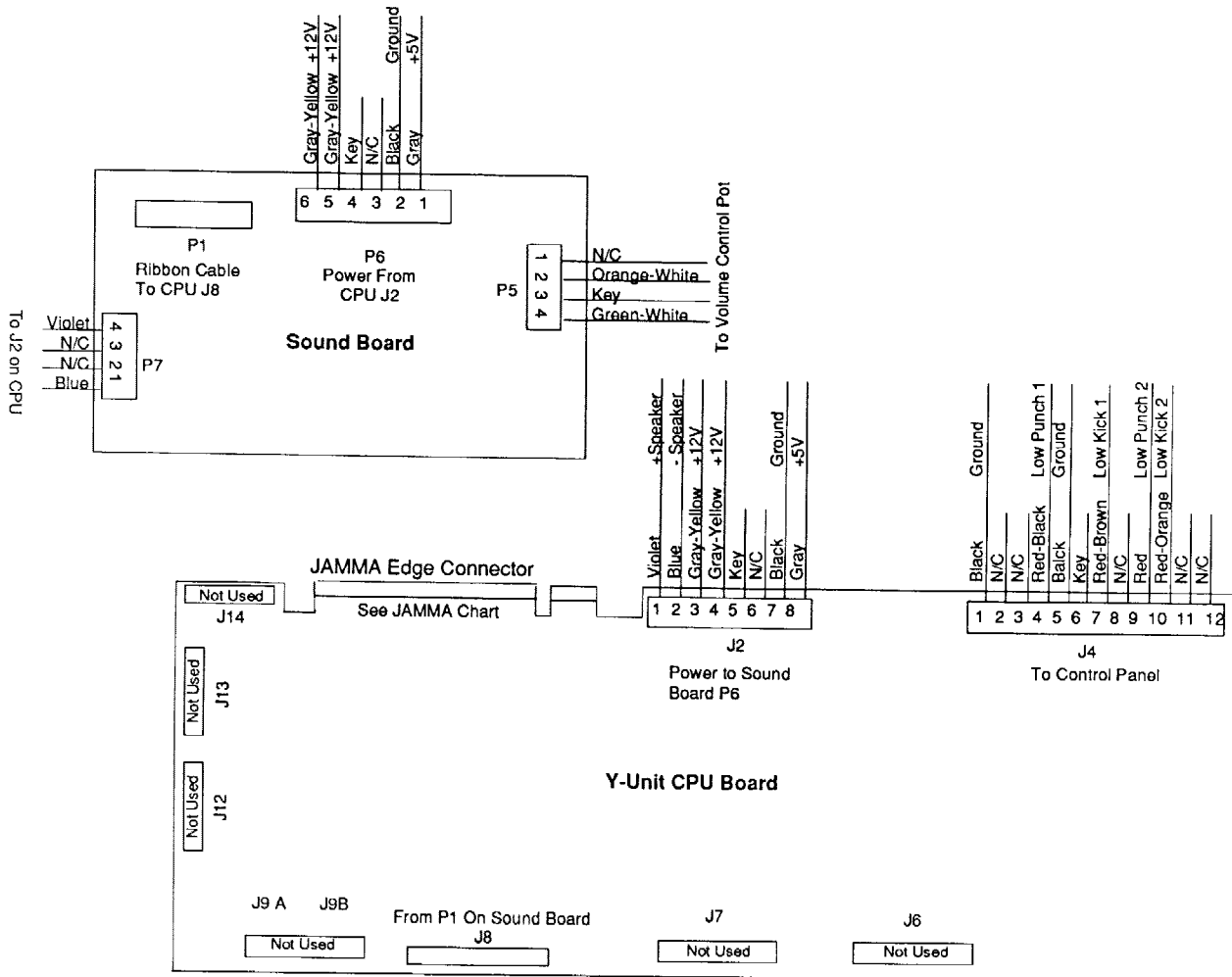

Coin Switch and Meter Wiring

Option 1

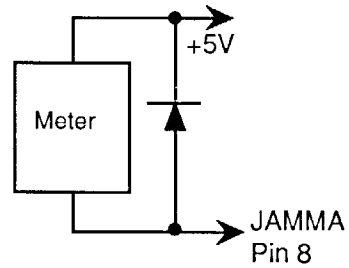
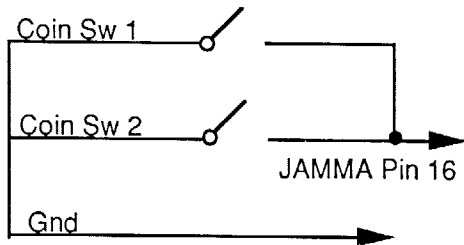

Option 2

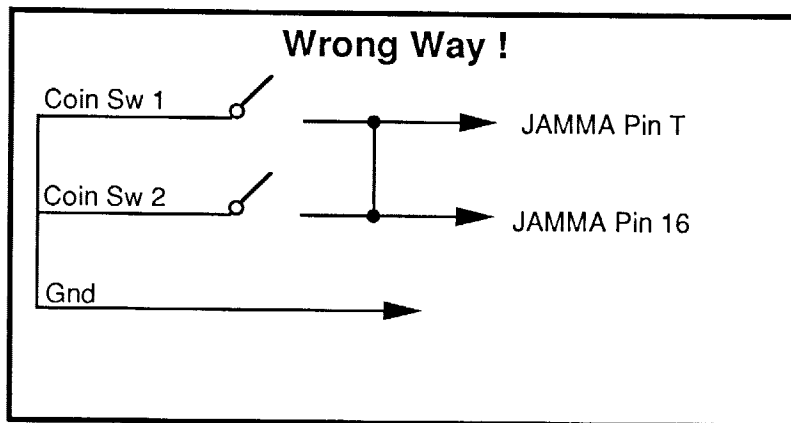
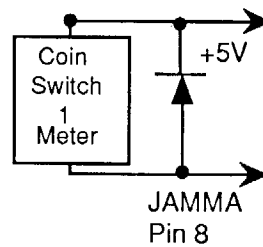
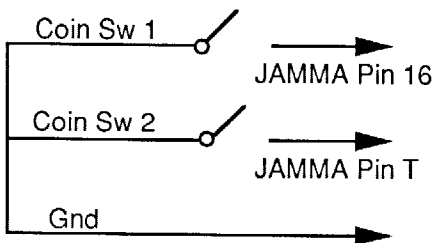

Do NOT Connect the coin switches this way.
This Circuit is INCORRECT and will cause twice as many credits per coin.

CPU
Sheet 1 of 16

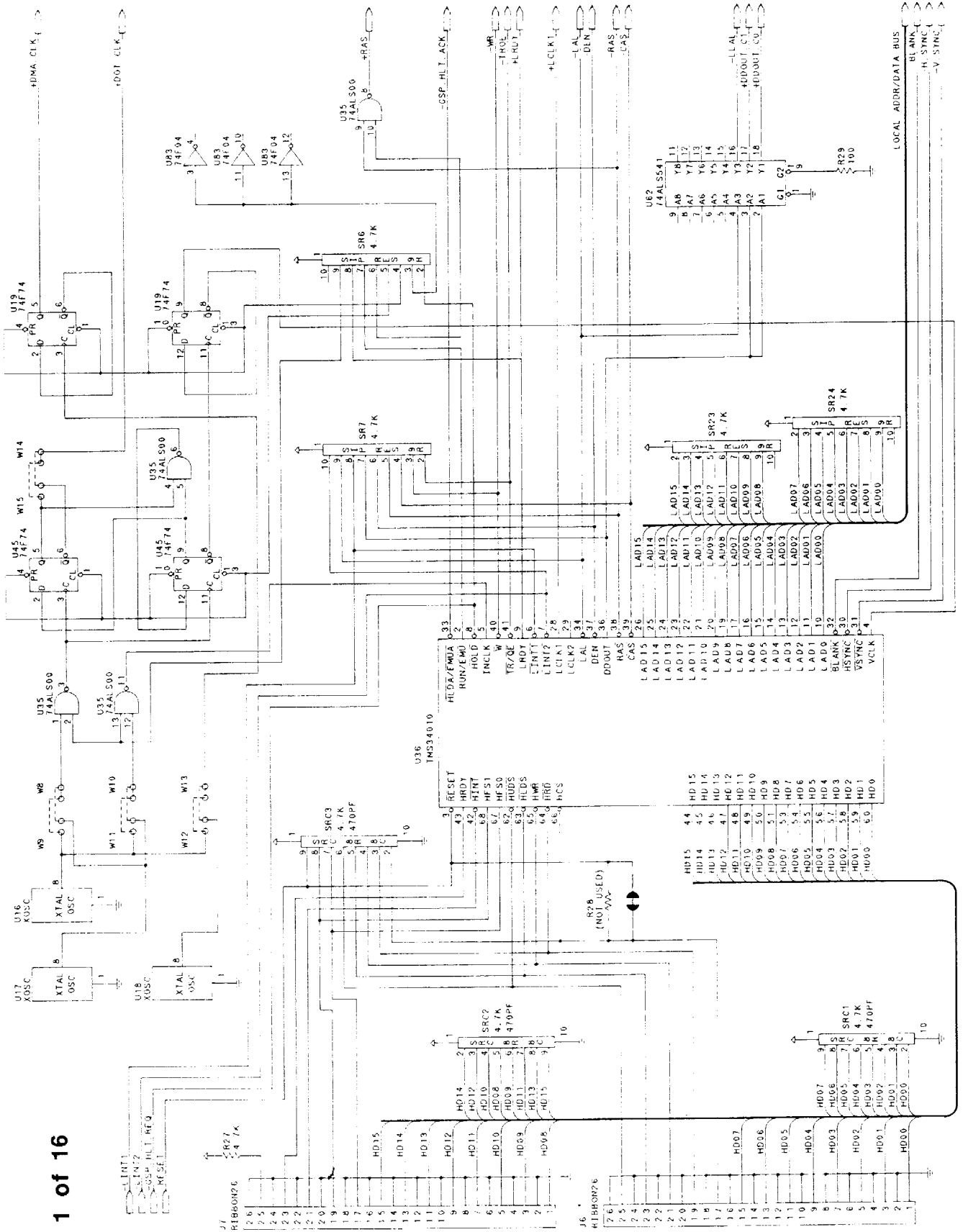

CPU
Sheet 2 of 16

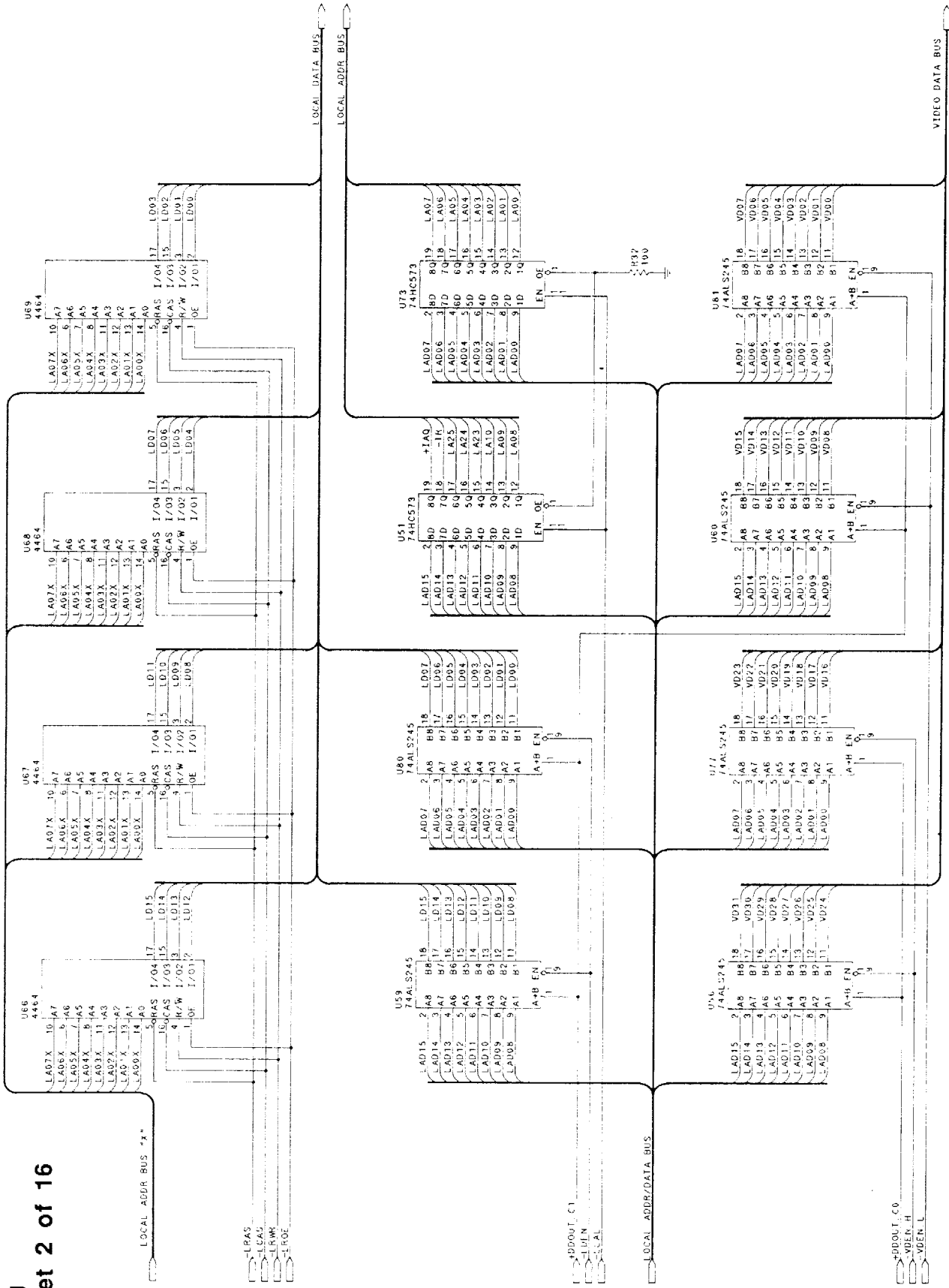

CPU Sheet 3 of 16

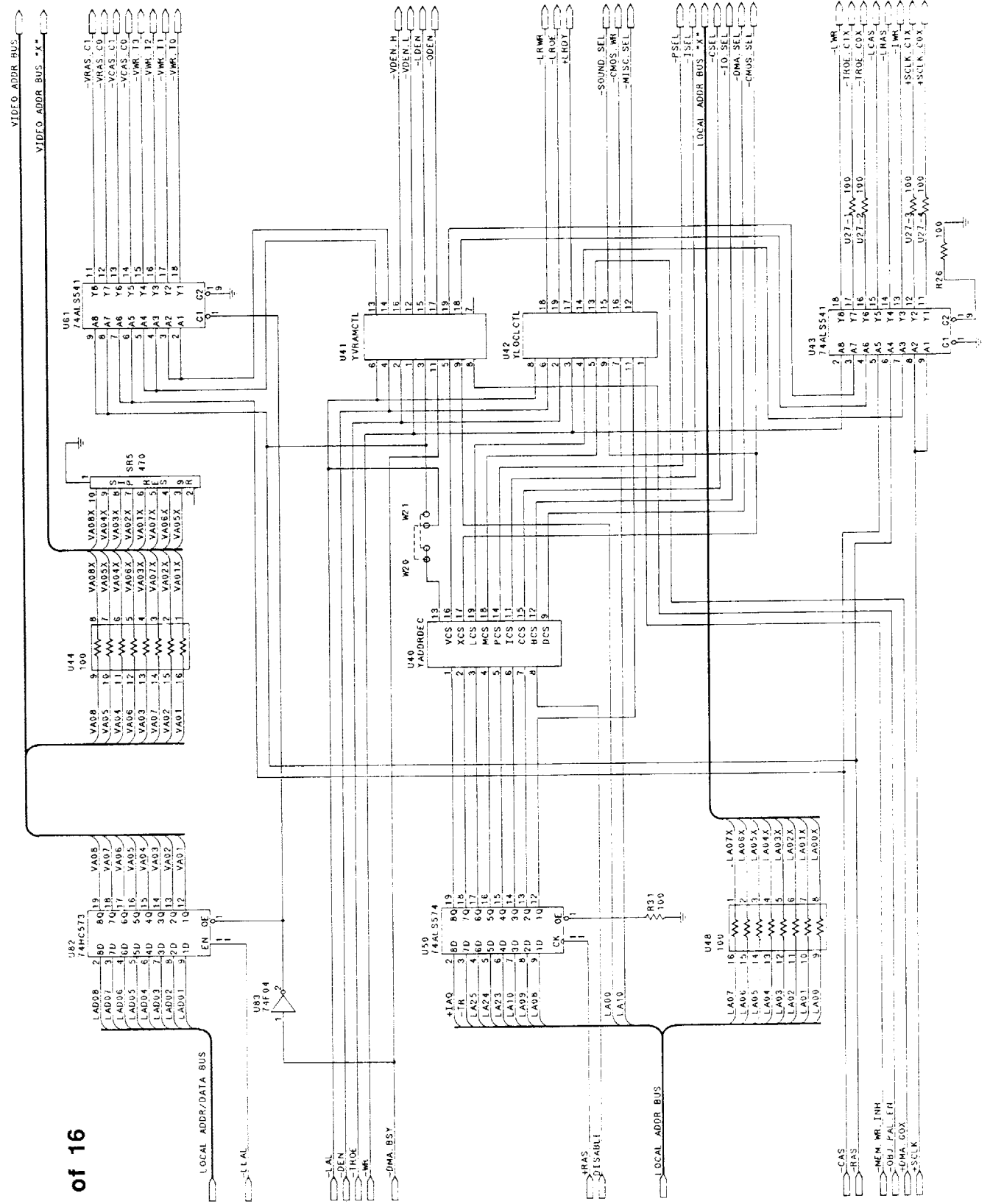

CPU Sheet 5 of 16

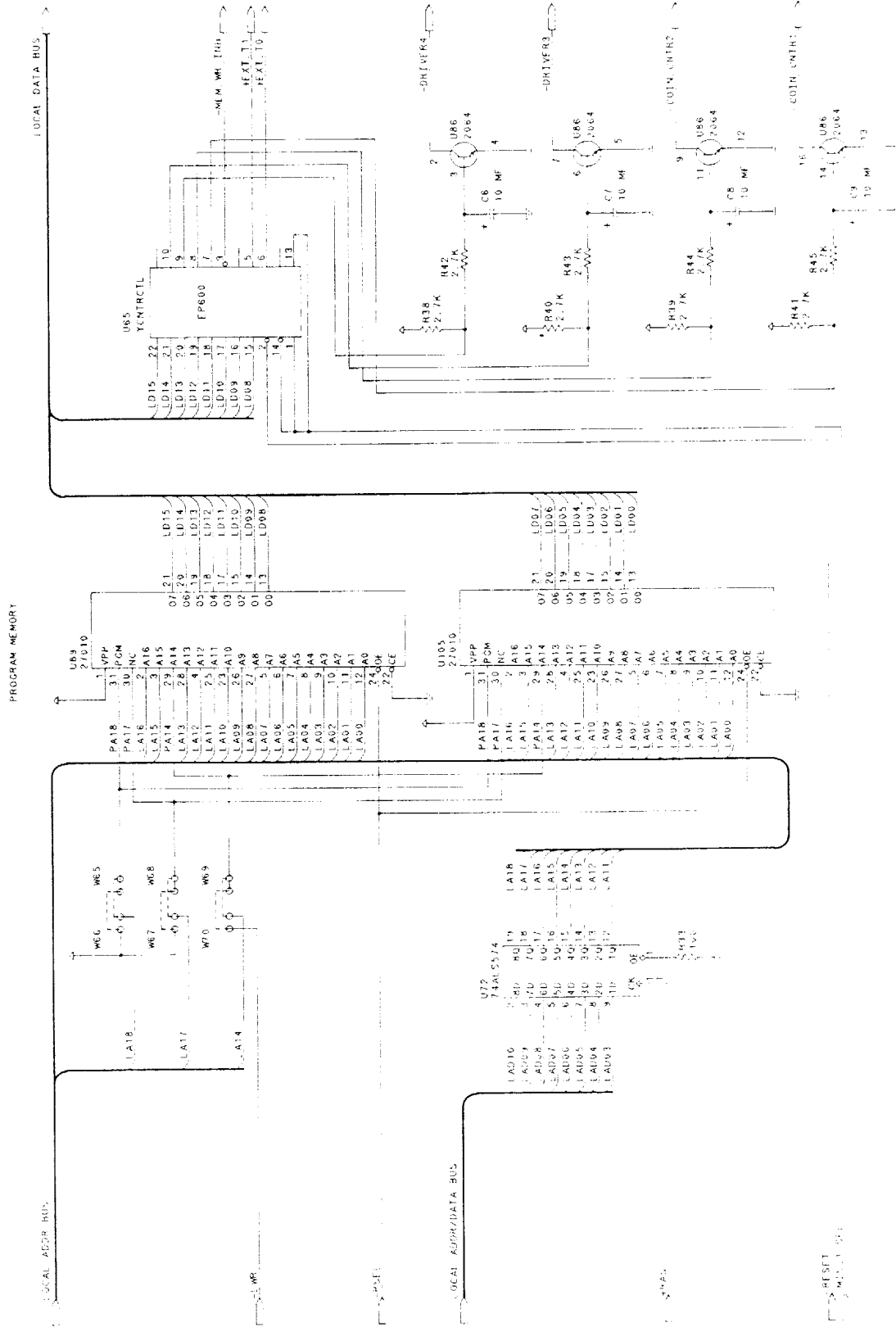

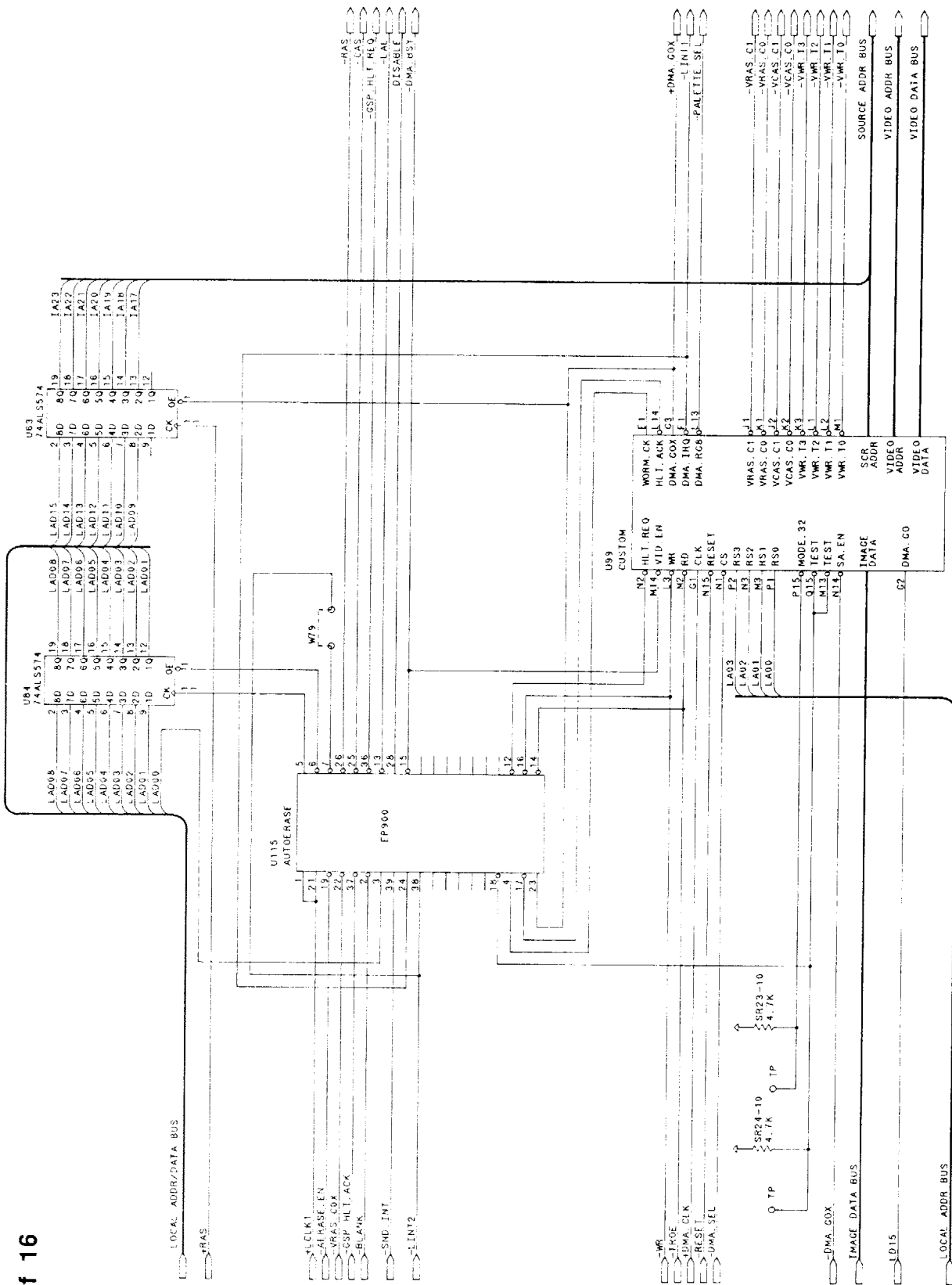
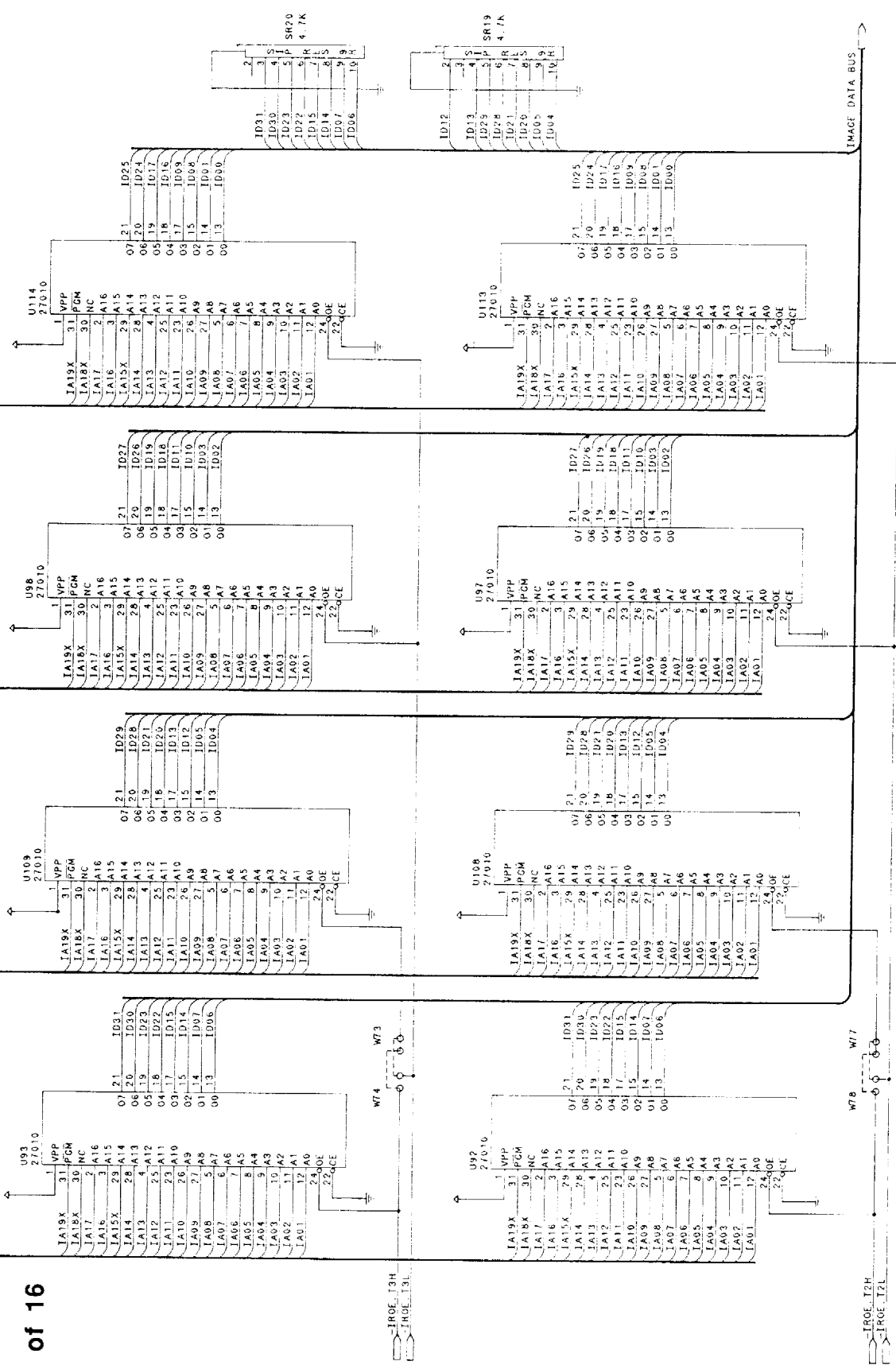

IMAGE ADDRESS BUS

IMAGE DATA BUS

CPU Sheet 8 of 16



CPU Sheet 10 of 16

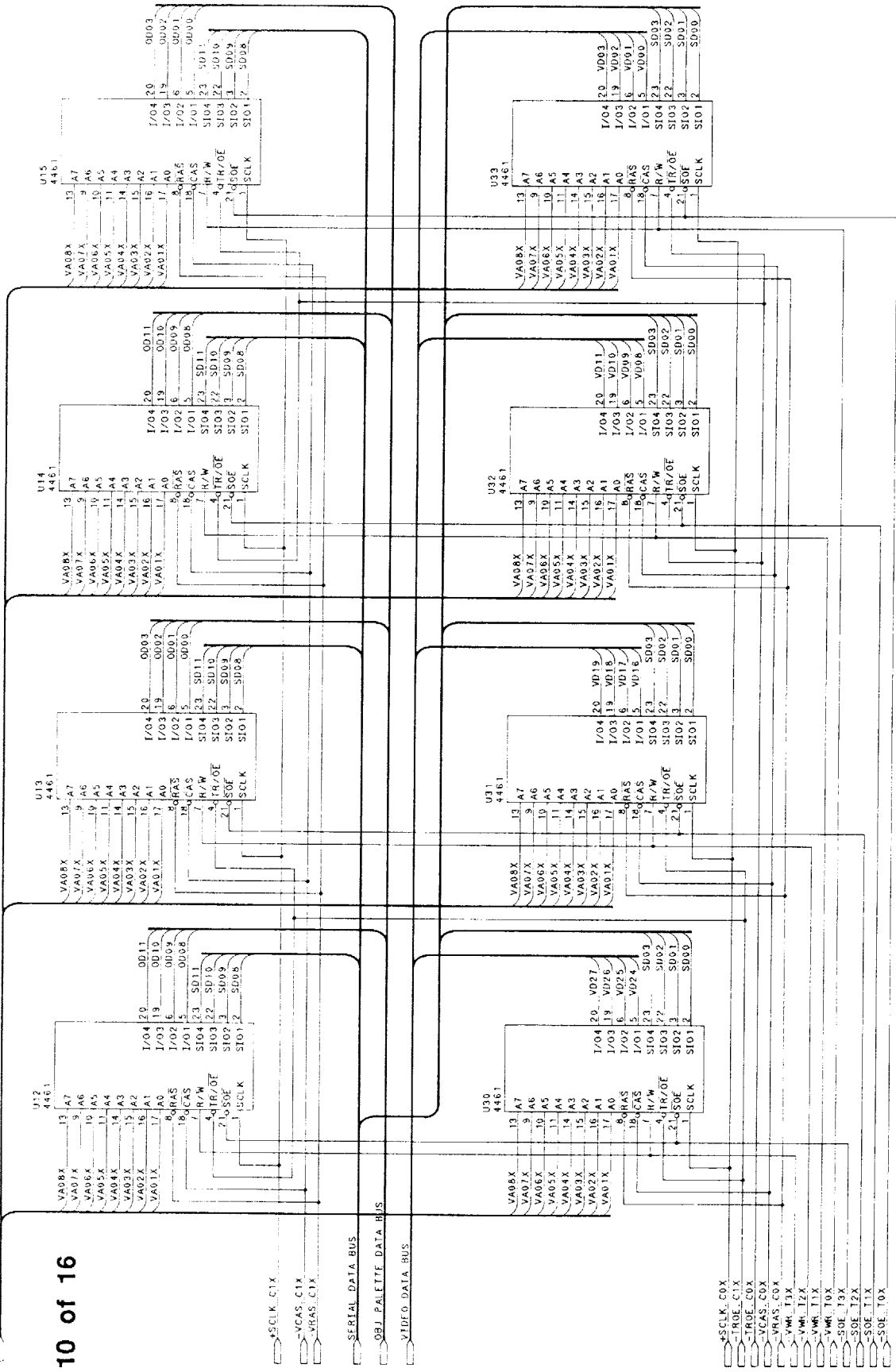

- SCLK_C1X
- VCAS_C1X
- VRAS_C1X
- SERIAL DATA BUS
- OBJ PALETTE DATA BUS
- VIDEO DATA BUS
- SCLK_C0X
- TR0E_C1X
- TR0E_C0X
- VCAS_C0X
- VRAS_C0X
- VMR_T1X
- VMR_T2X
- VMR_T0X
- S0E_T1X
- S0E_T2X
- S0E_T0X

CPU Sheet 11 of 16

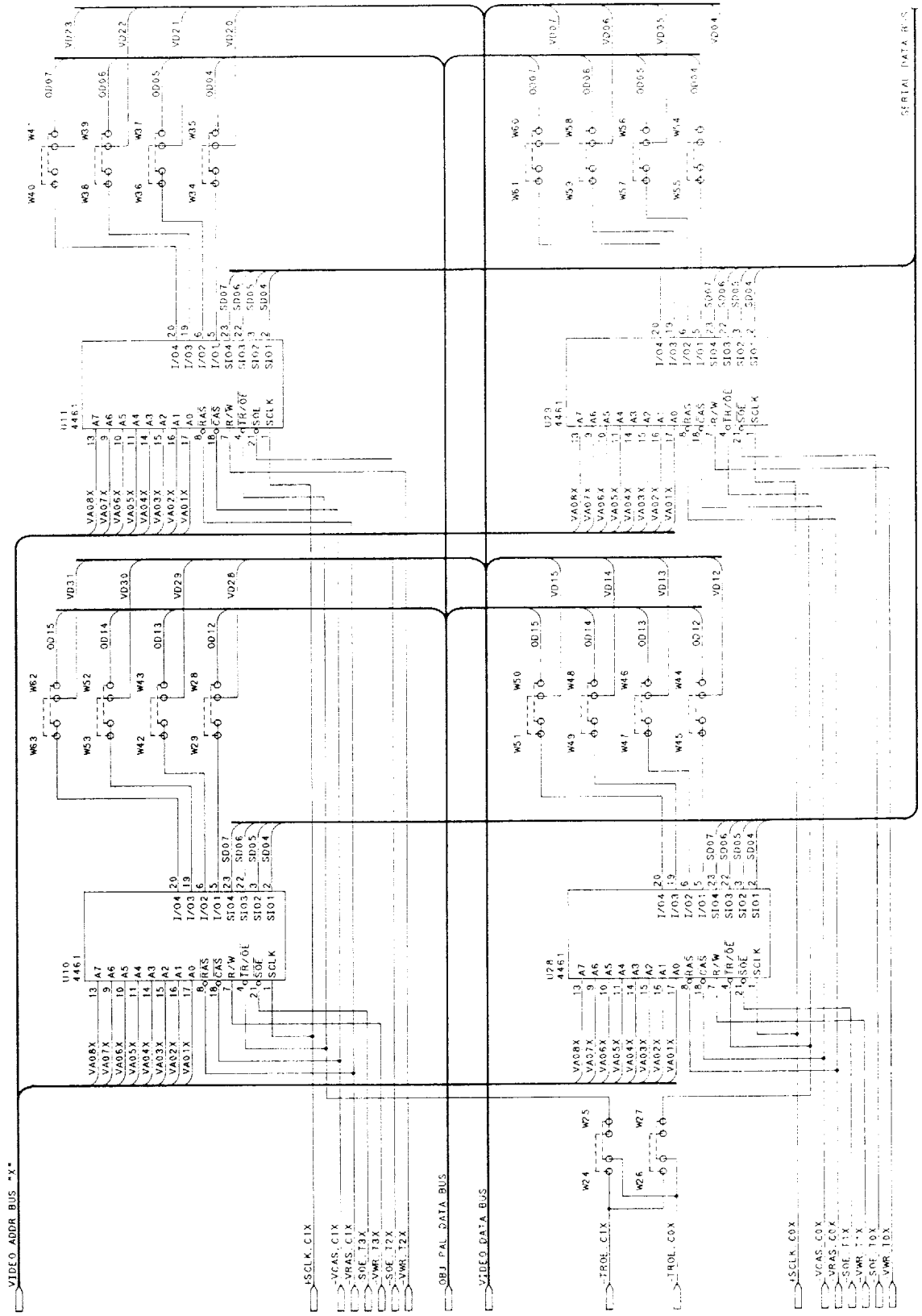

SERIAL DATA BUS

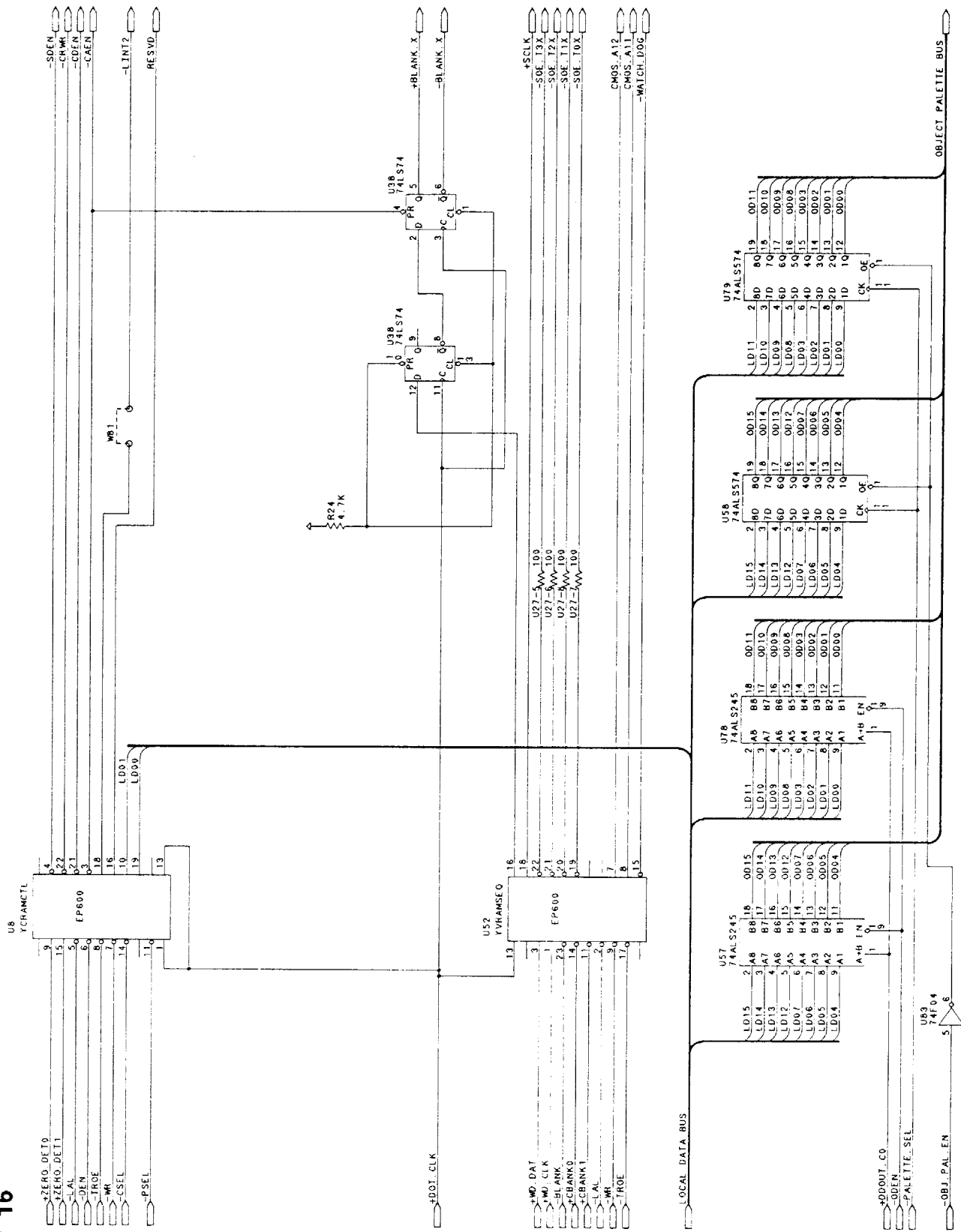

CPU
Sheet 13 of 16

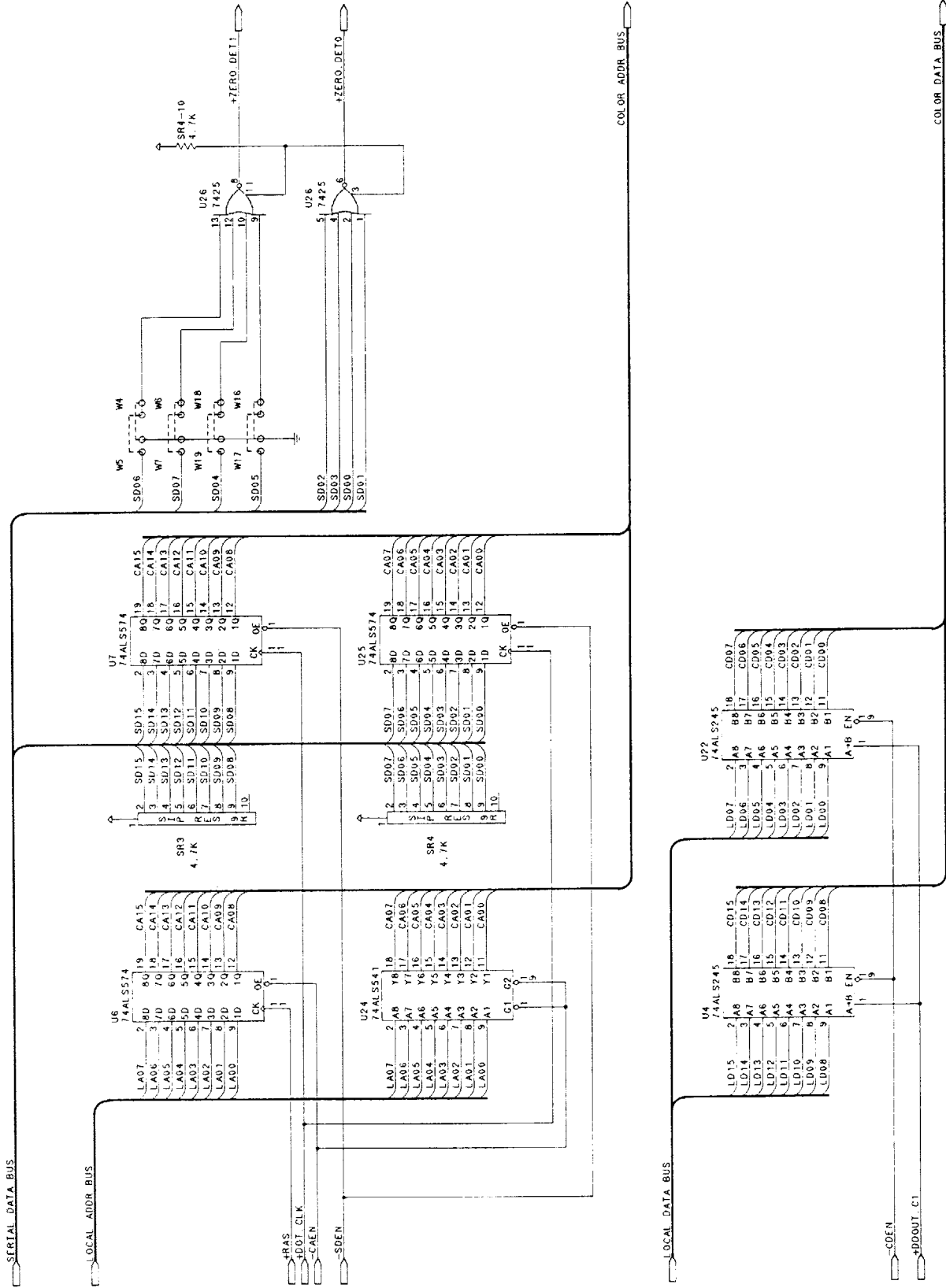

CPU Sheet 14 of 16

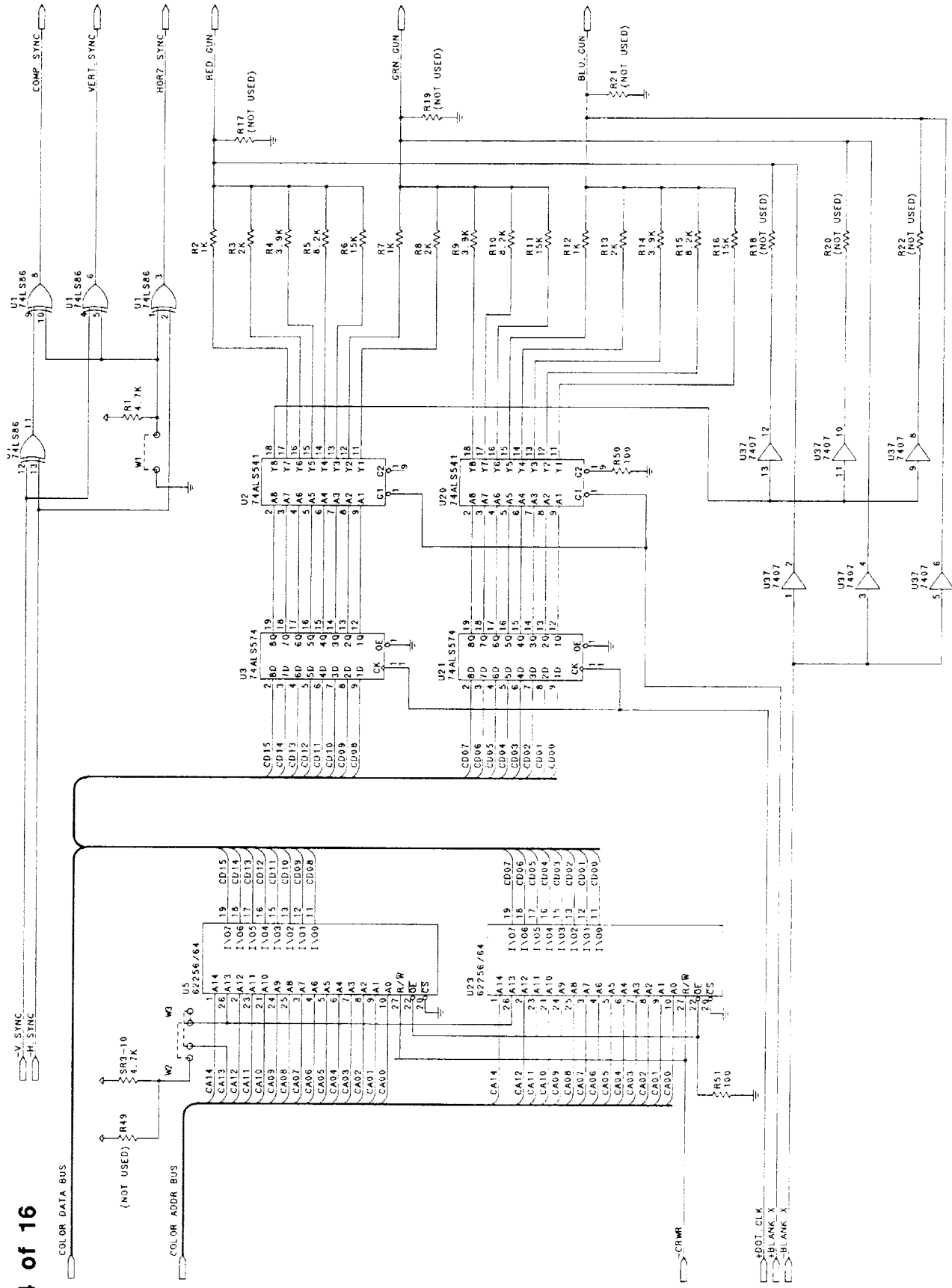

CPU
Sheet 15 of 16

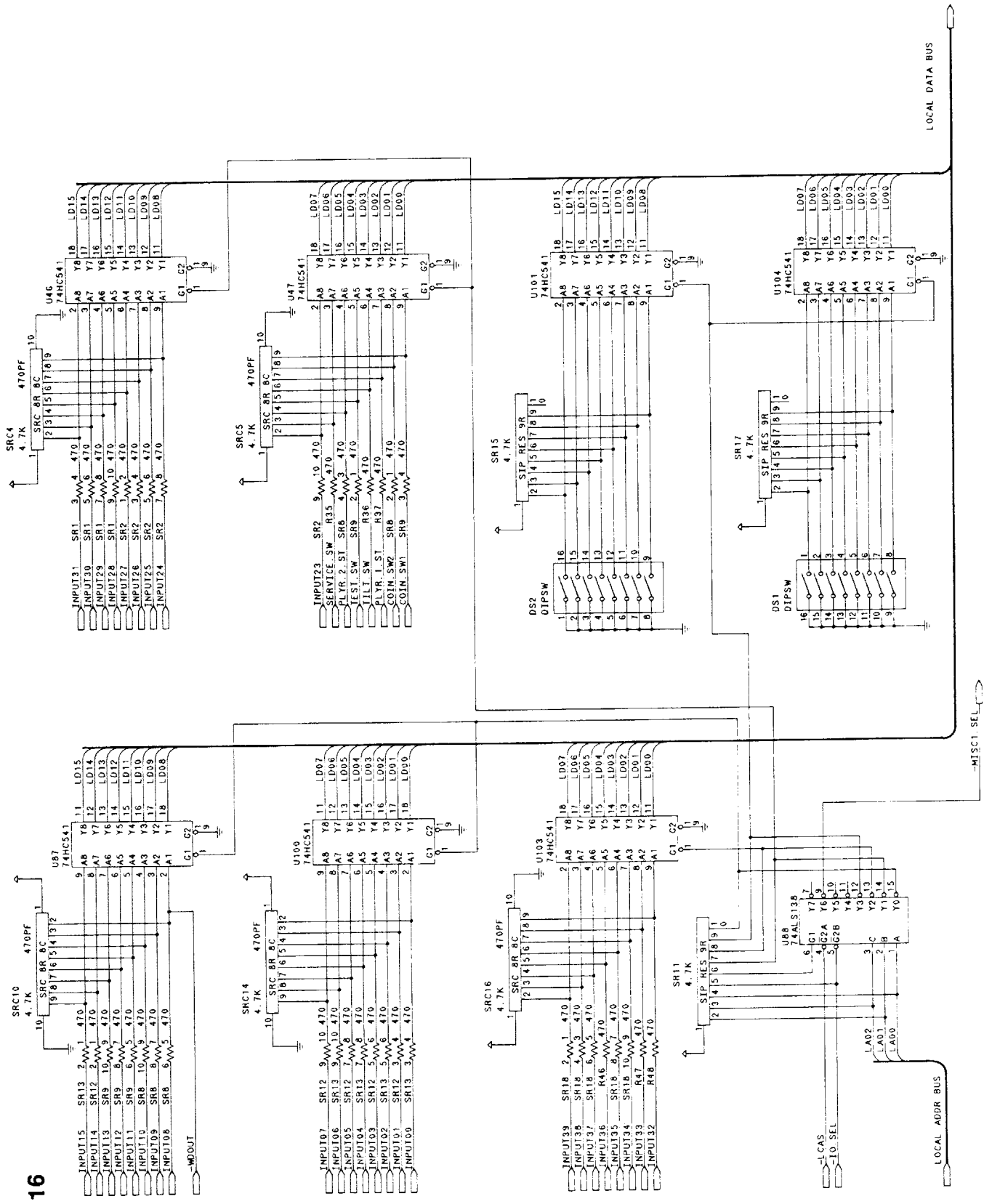

1	2	3	4	5	6	7	8
---	---	---	---	---	---	---	---

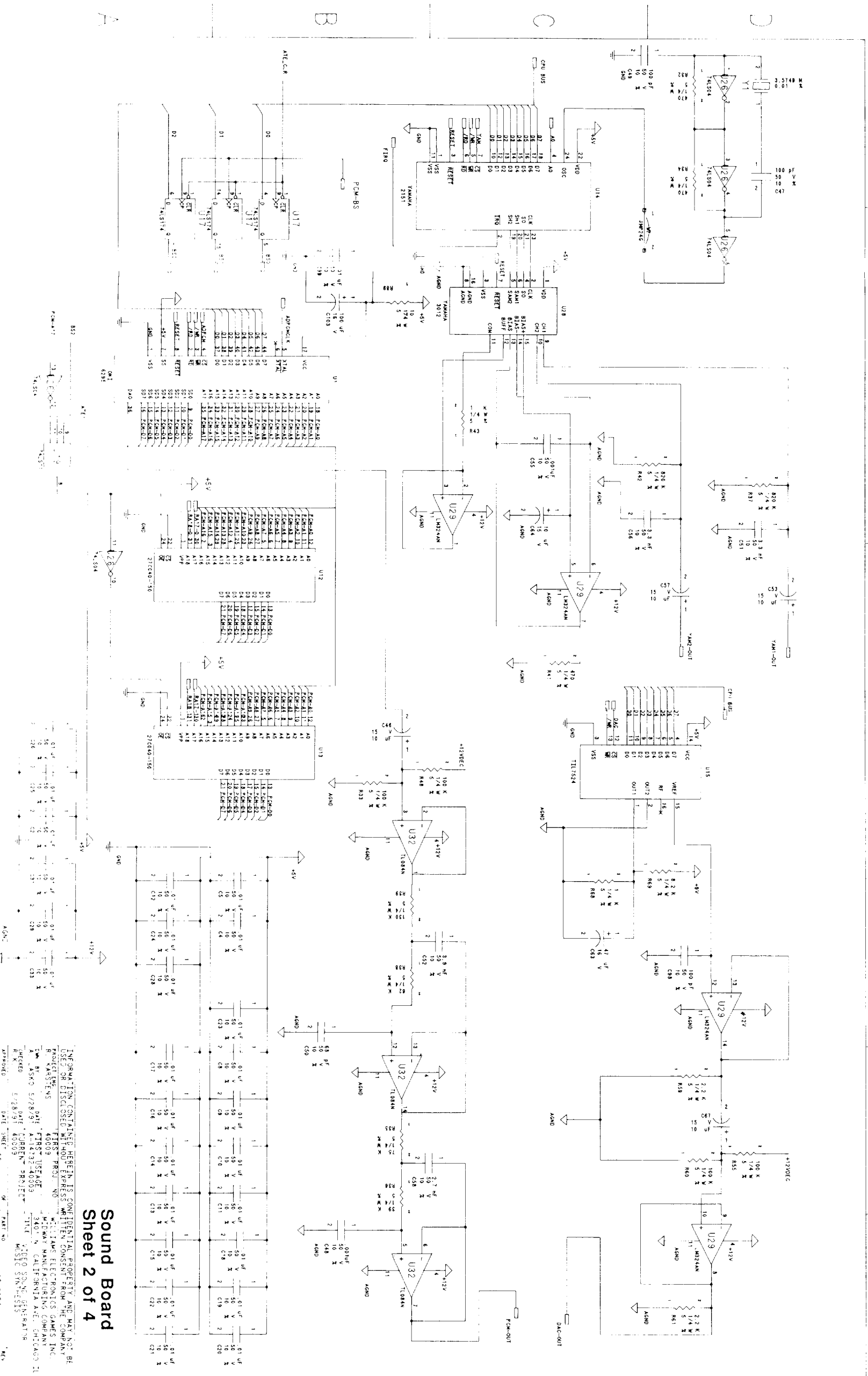

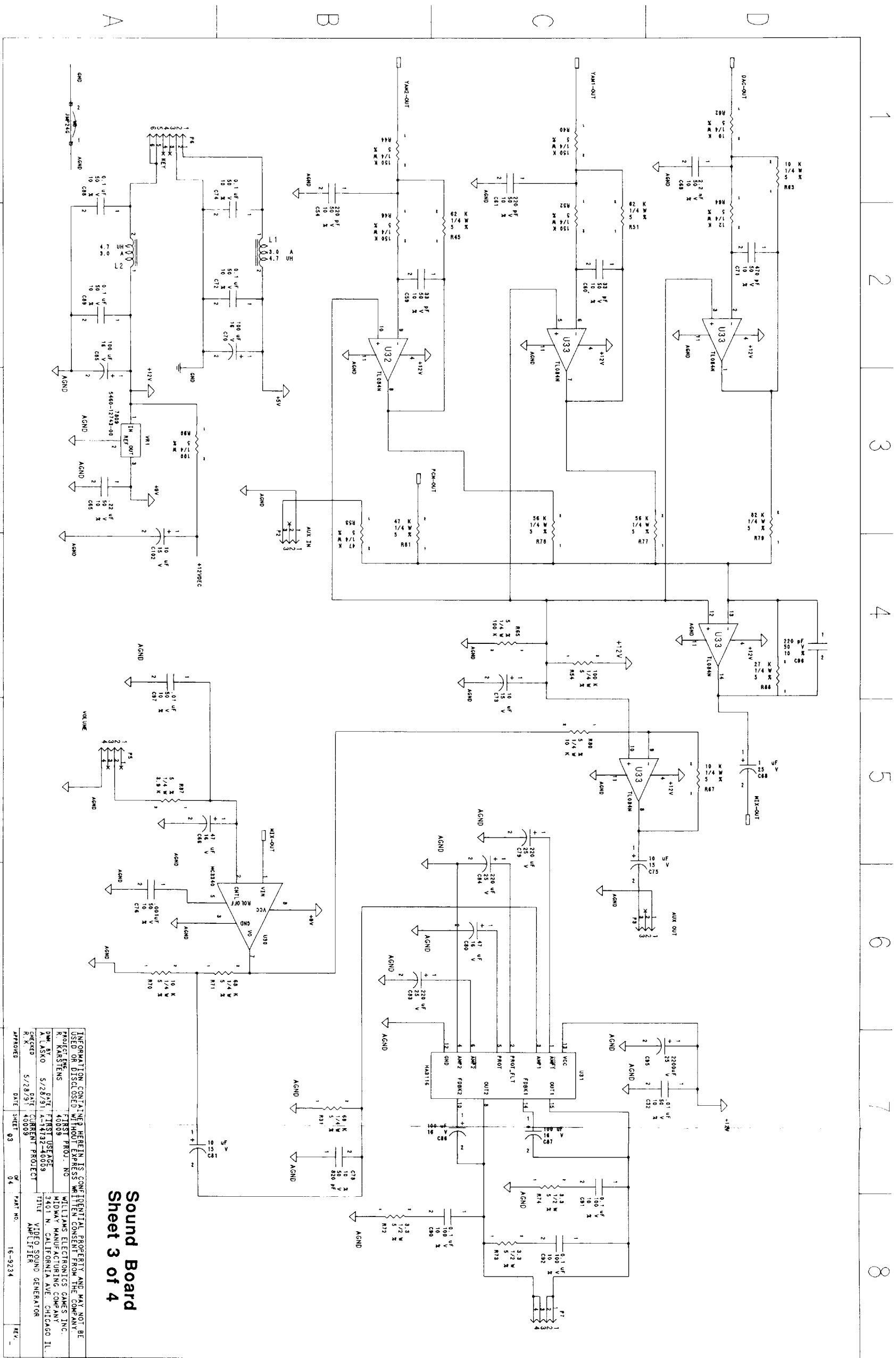

Sound Board
Sheet 3 of 4

INFORMATION CONTAINED HEREIN IS CONFIDENTIAL PROPERTY AND MAY NOT BE USED OR DISCLOSED WITHOUT EXPRESS WRITTEN CONSENT FROM THE COMPANY.
 R. KAESTENS
 4008 PROJ. NO. WILLIAMS ELECTRONICS COMPANY INC.
 340 N. CALIFORNIA AVE. CHICAGO IL
 60609
 DATE: 5/28/91
 TITLE: VIDEO SOUND GENERATOR
 CHECKED: A. LASCO
 DATE: 5/28/91
 PROJECT: 40009
 APPROVED: R. K. KAESTENS
 DATE: 5/28/91
 SHEET: 03 OF 04
 PART NO.: 16-9234
 REV.:

Control Panel Wire Colors

Player One

Start	Yellow-Green
Up (Jump)	Orange-Black
Down (Duck)	Orange-Brown
Left (Move)	Orange-Red
Right (Move)	Orange
High Punch	Orange-Yellow
Block	Orange-Green
High Kick	Orange-Blue
Low Punch	Red-Black
Low Kick	Red-Brown
Ground	Black

Player Two

Start	Yellow-Blue
Up (Jump)	Yellow-Black
Down (Duck)	Yellow-Brown
Left (Move)	Yellow-Red
Right (Move)	Yellow-Orange
High Punch	Yellow-Violet
Block	Yellow-Gray
High Kick	Violet-Black
Low Punch	Red
Low Kick	Red-Orange
Ground	Black

PC Board Jumpers

CPU Board

W2, W8, W11, W12, W14,
W21, W22, W24, W27, W29,
W30, W32, W34, W36, W39,
W41, W42, W45, W47, W48,
W50, W52, W55, W57, W58,
W60, W62, W65, W68, W69,
W71, W73, W75, W77, W80

Sound Board

W2, W3, W5, W7, W8

WARNINGS & NOTICES

Warning

USE OF NON-MIDWAY PARTS OR CIRCUIT MODIFICATIONS MAY CAUSE SERIOUS INJURY OR EQUIPMENT DAMAGE! USE ONLY MIDWAY AUTHORIZED PARTS.

- * For safety and reliability, substitute parts and modifications are not recommended.
- * Substitute parts or modifications may void FCC type acceptance.
- * This game is protected by federal copyright, trademark and patent laws. Unauthorized modifications may be illegal under Federal law. This also applies to MIDWAY logos, designs, publications and assemblies. Moreover, facsimiles of MIDWAY equipment (or any feature thereof) may be illegal under federal law, regardless of whether or not such facsimiles are manufactured with MIDWAY components.

Warning

Note: This equipment has been tested and found to comply with the limits for a Class A digital device, pursuant to Part 15 of the FCC Rules. These limits are designed to provide reasonable protection against harmful interference when the equipment is operated in a commercial environment. This equipment generated, uses and can radiate radio frequency energy and if not installed and used in accordance with the instruction manual, may cause harmful interference to radio communications. Operation of this equipment in a residential area is likely to cause harmful interference in which case the user will be required to correct the interference at his own expense.

Warning

Prevent shock hazard and assure proper game operation. Only plug this game into a properly grounded outlet. Do not use a cheater plug to defeat the power cord's grounding pin. Do not cut off the ground pin.

Notice

When MIDWAY ships a game, it is in compliance with FCC regulations. Your sticker is proof. If the sticker is missing or damaged, legal repercussions to the owner or distributor of the game may result. If your game does not contain an FCC sticker, call MIDWAY immediately.

Notice

No part of this publication may be reproduced by any mechanical, photographic, or electronic process, or in the form of a phonographic recording, nor may be transmitted, or otherwise copied for public or private use, without permission from the publisher.

Entire contents of this manual copyright © 1992 MIDWAY Manufacturing Company, INC. All Rights Reserved.

FOR SERVICE:

CALL YOUR AUTHORIZED MIDWAY DISTRIBUTOR.

MIDWAY Manufacturing Company
3401 N. CALIFORNIA AVE.
CHICAGO, IL 60618