

**KITKORP**

FOR HORIZONTAL MONITOR GAMES

**VISIT YOUR FAVORITE CITY!!**

LET'S GO

# CRUISE

Licensed From **JALECO** Ltd.™

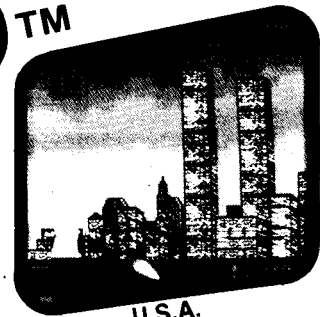
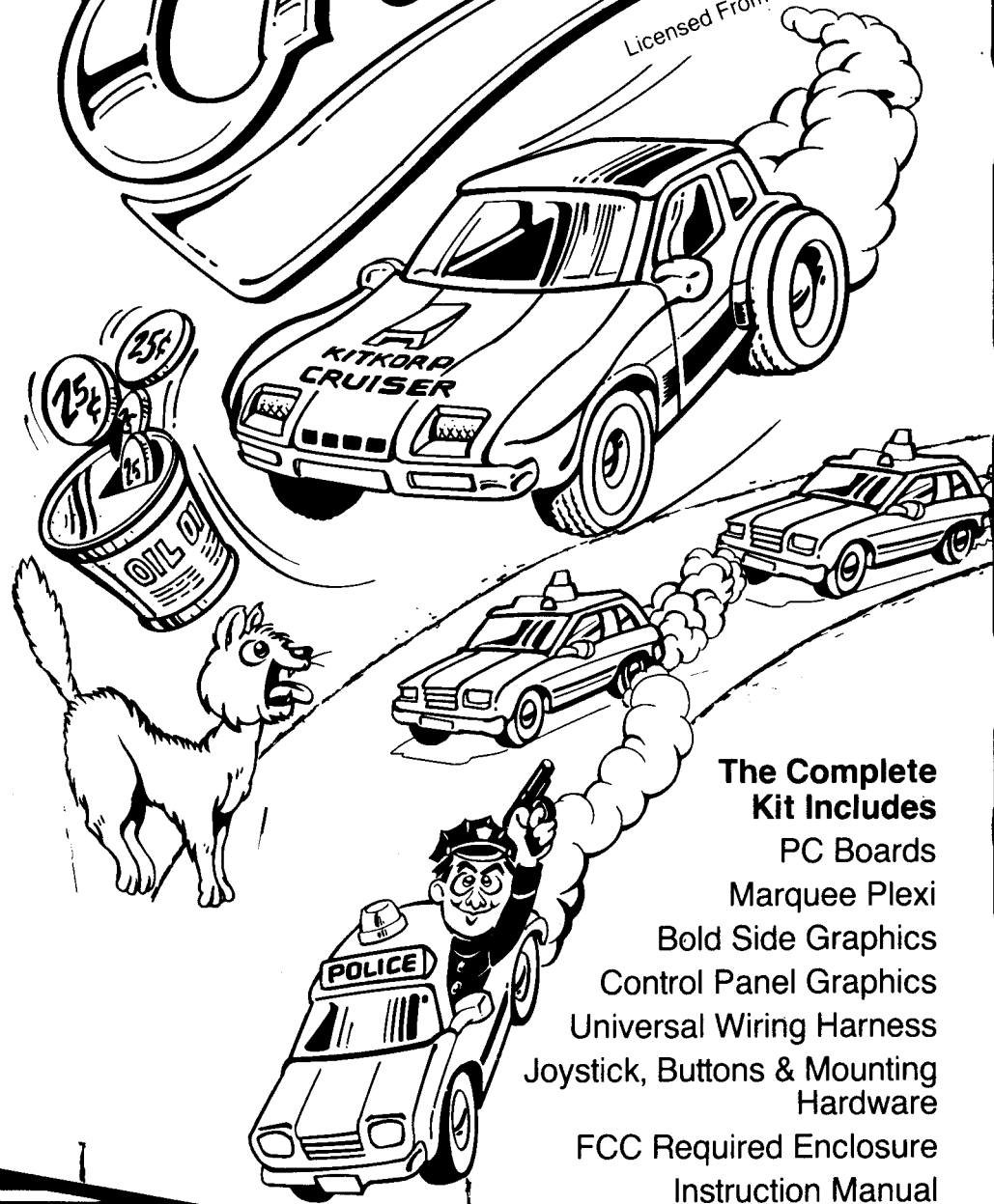

U.S.A.

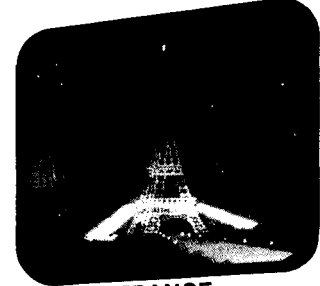

FRANCE



ENGLAND

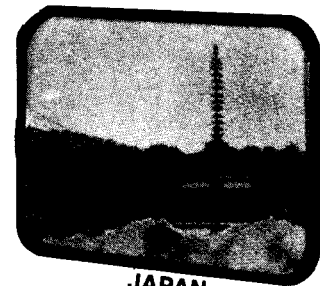

JAPAN

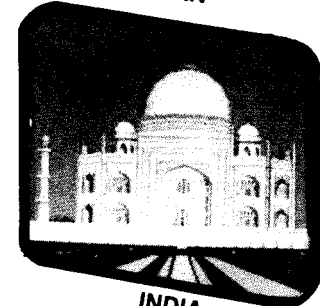

INDIA

- The Complete Kit Includes**
- PC Boards
  - Marquee Plexi
  - Bold Side Graphics
  - Control Panel Graphics
  - Universal Wiring Harness
  - Joystick, Buttons & Mounting Hardware
  - FCC Required Enclosure
  - Instruction Manual

**KITKORP**

2250 Elmhurst Rd.  
 Elk Grove, IL 60007 • (312) 228-0451  
 Fax: (312) 228-1563 • Telex: 206424 Kitkorp

## INSTALLATION

Cruisin' requires a cabinet with a horizontally-mounted rasterscan monitor, a power supply with +5V and +12V sources, and a control panel with mounting holes for a 4-way joystick and *four* buttons. There are two "OIL" buttons and two "JUMP" buttons. The "OIL" button doubles as 1-player start and the "JUMP" button doubles as 2-player start. Separate buttons for 1 and 2 player start are not needed. If you wish to use separate buttons for these, you will need to add two wires to the edge connector (see diagram).

1. Remove existing game wiring harness, leaving the AC wiring intact.
2. Remove all buttons and joysticks from existing control panel. Refer to the Control Panel Layout diagram in this manual. Apply the Cruisin' overlay and cut out the holes before you install the Cruisin buttons and joystick. Apply control panel decals.
3. Install the Cruisin' Universal Wiring Harness. Refer to the edge connector diagram for game wiring.
4. Install Cruisin' Marquee and Side Decals.

## USER INFORMATION

# WARNING

## F.C.C. REGULATION COMPLIANCE

THE P.C. BOARD CAGE SUPPLIED WITH THIS CONVERSION KIT MUST BE UTILIZED AND TERMINATED TO GROUND AT THE TIME OF INSTALLATION.

THIS IS TO AVOID RADIO FREQUENCY RADIATION AND COMPLY WITH THE LIMITS FOR A CLASS "A" COMPUTING DEVICE PURSUANT TO SUBPART "J" OF PART 15 OF F.C.C. RULES, WHICH ARE DESIGNED TO PROVIDE REASONABLE PROTECTION AGAINST SUCH INTERFERENCE WHEN OPERATED IN A COMMERCIAL ENVIRONMENT.

OPERATION OF THIS EQUIPMENT IN A RESIDENTIAL AREA IS LIKELY TO CAUSE INTERFERENCE — IN WHICH CASE, THE USER AT HIS OWN EXPENSE, WILL BE REQUIRED TO TAKE WHATEVER MEASURES MAY BE REQUIRED TO CORRECT THE INTERFERENCE.

**PARTS SIDE**

**SOLDER SIDE**

BLK	GND	1	A	GND	BLK
BLK	GND	2	B	GND	BLK
		3	C		
WHT-BLK	SPKR+	4	D	SPKR-	BLK
RED-BLK	+5V	5	E	+5V	RED-BLK
		6	F		
WHT (TO 15)	1P START**	7	H	2P START**	WHT (TO 16)
YEL	COINSWITCH	8	J		
		9	K		
ORN	+12V	10	L		
YEL-BLK	1P UP	11	M		
WHT-RED	1P DOWN	12	N		
VIO	1P RIGHT	13	P		
WHT-GRN	1P LEFT	14	R		
GRY WHT (TO 7)	1P OIL*	15	S		
WHT-BLU	1P JUMP**	16	T		
RED	VID RED	17	U	VID BLU	BLU
GRN	VID GRN	18	V	NEG COMP SYNC	WHT

\*PIN 15 IS JUMPERED TO PIN 7

\*\*PIN 16 IS JUMPERED TO PIN H.

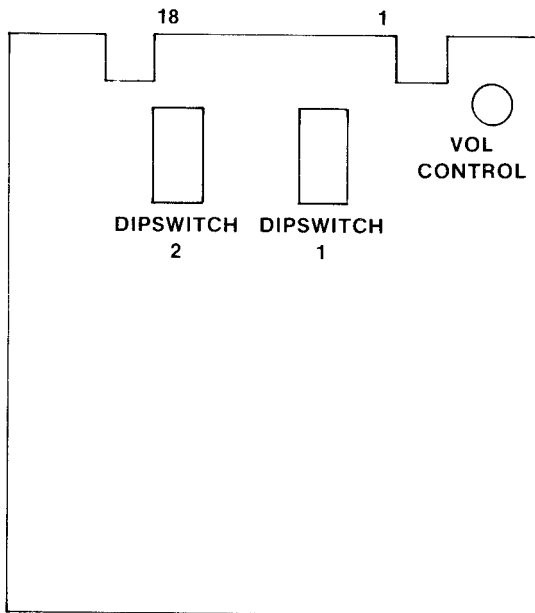

**DIPSWITCH 1**

	1	2	3	4	5	6	7	8
3 CARS	ON	ON						
4 CARS	OFF	ON						
5 CARS	ON	OFF						
UNLIMITED CARS	OFF	OFF						
NOT USED			OFF	OFF	OFF			OFF
ATTRACT MODE SOUND						ON		
NO ATTRACT MODE SOUND						OFF		
COCKTAIL MODE							OFF	
UPRIGHT MODE							ON	

**DIPSWITCH 2**

	1	2	3	4	5	6	7	8
COINS/CREDIT 1/1	ON	ON	ON					
1/2	OFF	ON	ON					
1/3	ON	OFF	ON					
1/4	OFF	OFF	ON					
2/1	ON	ON	OFF					
3/1	OFF	ON	OFF					
4/1	ON	OFF	OFF					
5/1	OFF	OFF	OFF					
EASY				OFF				
HARD				ON				
NOT USED					OFF	OFF	OFF	
SCREEN								OFF
INVERT								ON

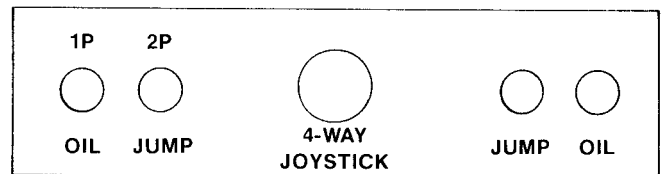

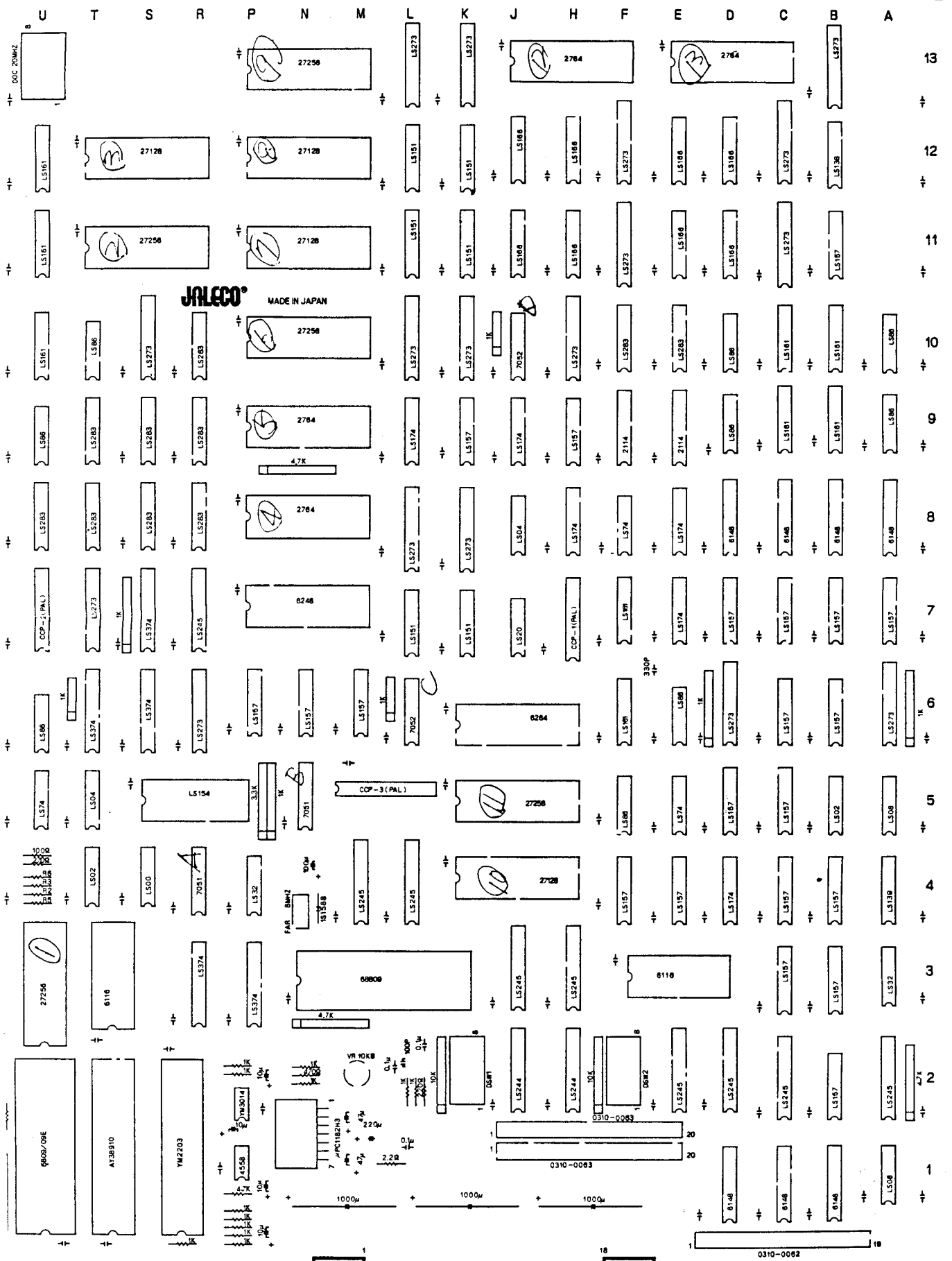

**JALCO** MADE IN JAPAN

13  
12  
11  
10  
9  
8  
7  
6  
5  
4  
3  
2  
1

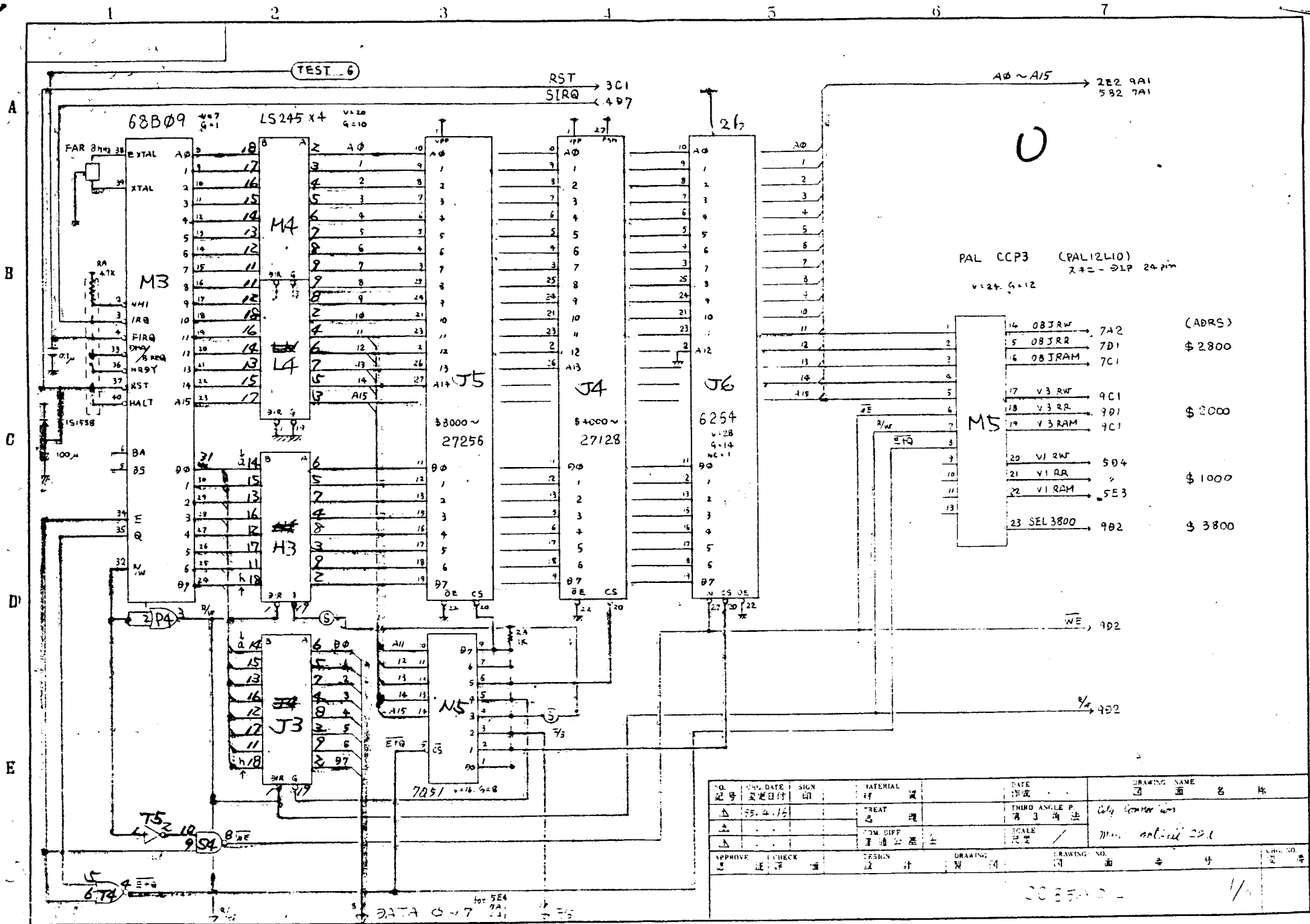

NO. 記号	REV. DATE 変更日付	SIGN 印	MATERIAL 材 質	DATE 作成	DRAWING NAME 図 面 名 称
△	55.4.16		TREAT 理	THIRD ANGLE P. 第 3 角 法	City Center 10m
△			FORM DIFF 軍 通 公 差	SCALE 尺 寸	1mm = actual 22.1
APPROVE 承認	CHECK 確認	DESIGN 設計	DRAWING 製 図	DRAWING NO. 図 面 番 号	CHECK NO. 検 査 番 号
				008540-1	1/1



PNOS 3-3

A  
B  
C  
D  
E

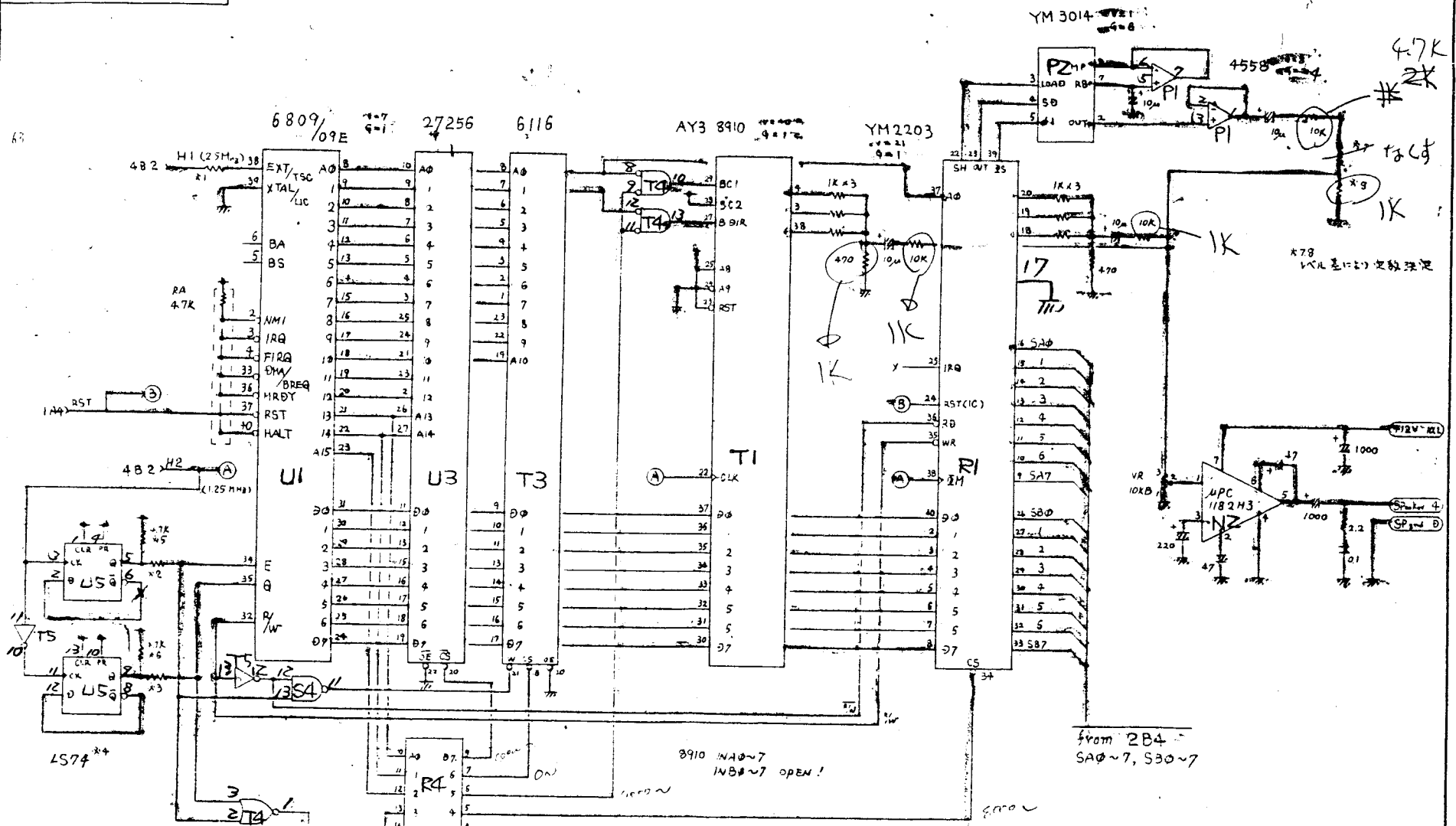

注) 本1 6809使用時のみ取付  
※2,3,4,5,6  
6809E使用時のみ取付

7051 1416  
6.8

(TEST)  
本機  
2.12.10.11.

NO 記号	CHG. DATE 変更日付	SIGN 印	MATERIAL 材 質	DATE 作成	DRAWING NAME 図 面 名 称
△			TREAT 処 理	THIRD ANGLE P 第 3 角 法	City Connection
△			CON. DIFF 寸 法 公 差	SCALE 尺 寸	Sound Block
APPROVE 認 可	DESIGN 設 計	DRAWING 製 図	DRAWING NO. 番 号	CHG. NO. 変 更	

CC85A02





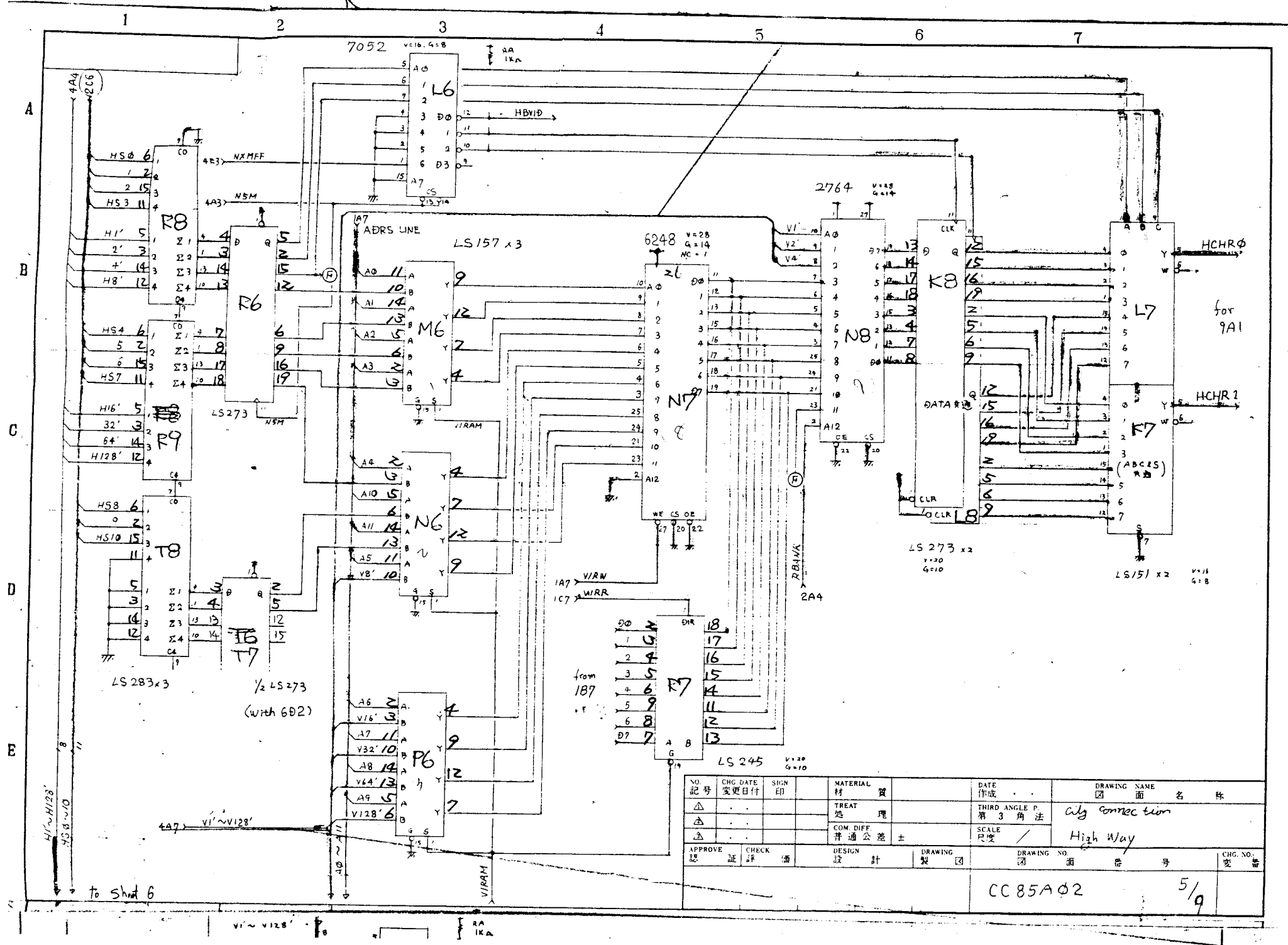

NO. 記号	CHG. DATE 变更日期	SIGN 印	MATERIAL 材 質	DATE 作成	DRAWING NAME 圖 面 名 称
△			TREAT 处 理	THIRD ANGLE P. 第 3 角 法	city connection
△			COM. DIFF. 普通公差 ±	SCALE 尺 寸	High Way
APPROVE 認 証	CHECK 評 價	DESIGN 設 計	DRAWING 製 圖	DRAWING NO. 圖 面 番 号	CHG. NO. 變 番
				CC85A02	5/9





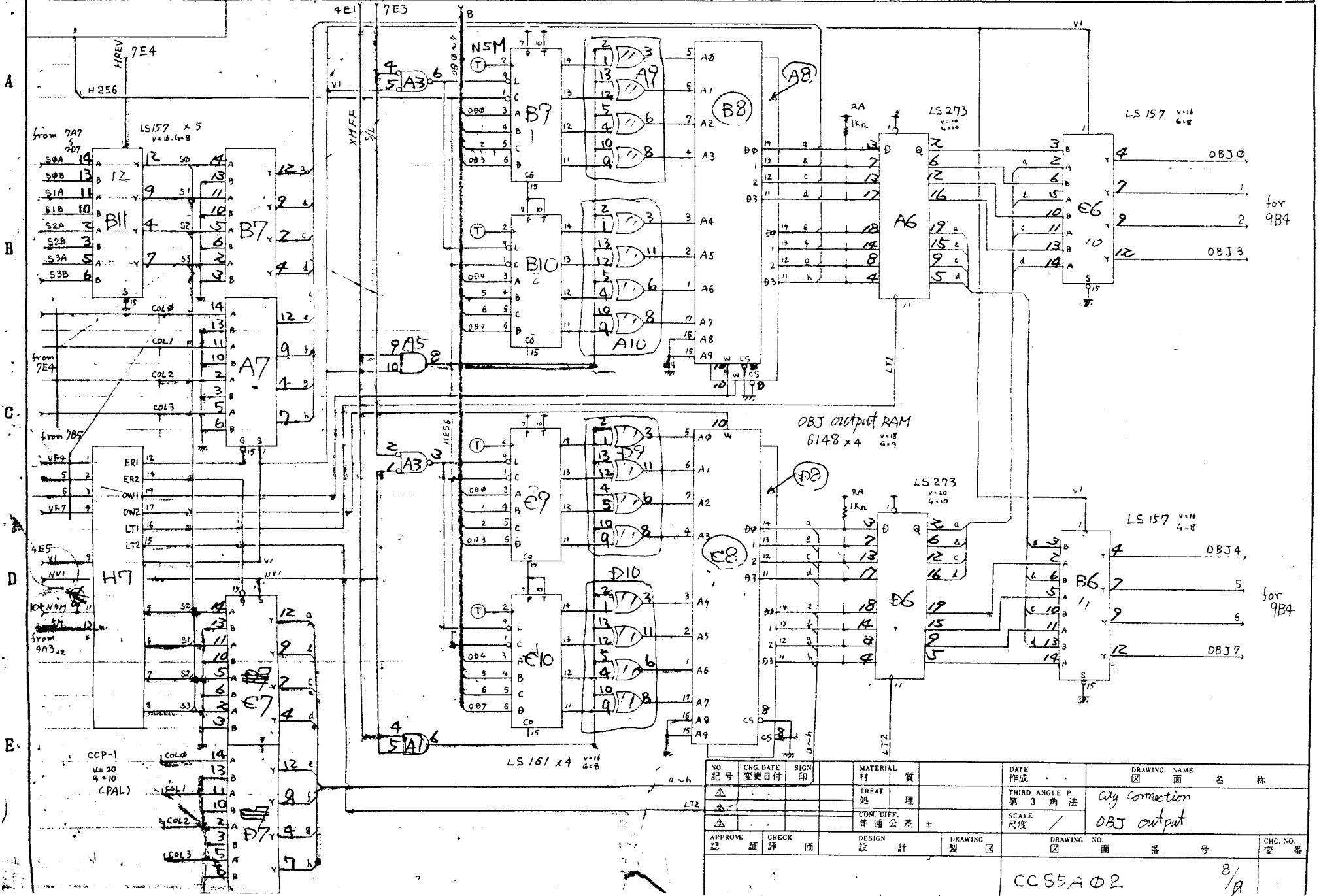
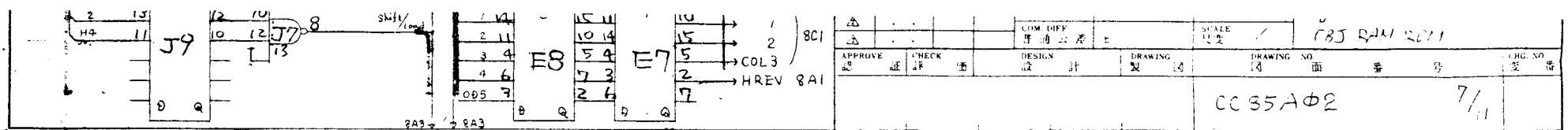

NO 記号	CHG. DATE 變更日付	SIGN 印	MATERIAL 材 質	DATE 作成	DRAWING NAME 圖 面 名 稱
△			TREAT 処 理	THIRD ANGLE P. 第 3 角 法	city connection
△			COM DIFF. 普通公差 ±	SCALE 尺 度	OBJ output
△					

APPROVE 認	CHECK 証 評 価	DESIGN 設 計	DRAWING 製 圖	DRAWING NO 圖 面 番 號	CHG. NO. 變 更 番 號
				CC35AΦ2	8/9

1 2 3 4 5 6 7

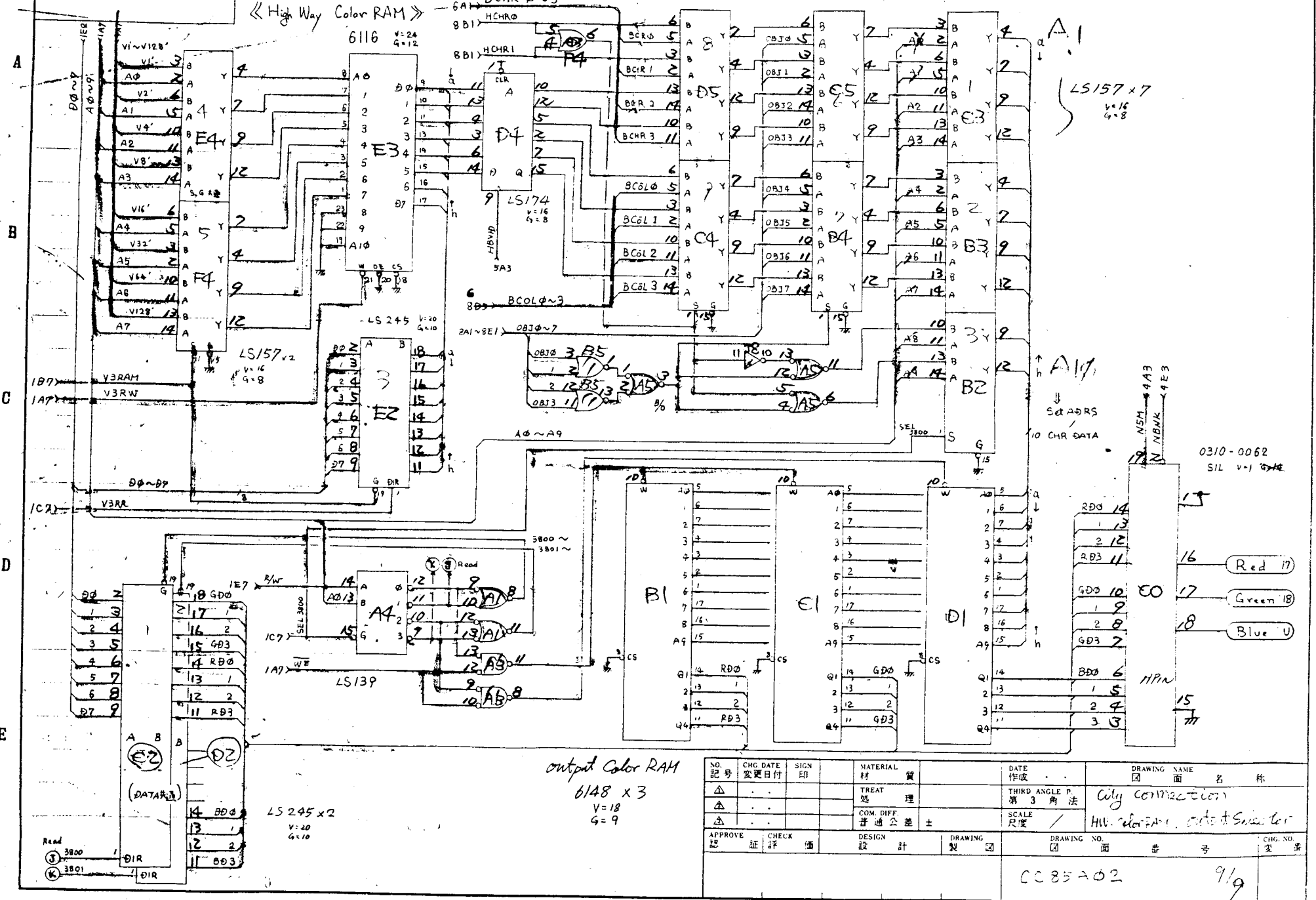

output Color RAM  
6148 x 3  
V=18  
G=9

NO. 記号	CHG DATE 変更日付	SIGN 印	MATERIAL 材 質	DATE 作成	DRAWING NAME 図 面 名 称
△			TREAT 処 理	THIRD ANGLE P. 第 3 角 法	City Connection
△			COM. DIFF. 普通公差 ±	SCALE 尺 度 /	Hiroshima, output Color RAM
APPROVE 認 証	CHECK 評 価	DESIGN 設 計	DRAWING 製 図	DRAWING NO. 図 面 番 号	CHG. NO. 変 更 号
				CC85-02	9/9