

# MIDWAY'S

# Galaxian

## TROUBLE SHOOTING LOGIC BOARD PART II



PHONE  
(312) 451-1360



**MIDWAY MFG. CO.**  
A BALLY COMPANY  
10750 WEST GRAND AVENUE  
FRANKLIN PARK, ILLINOIS 60131  
U.S.A.

PHONE  
TOLL FREE  
800-323-7183

# Galaxian

**GALAXIAN**, Midway's new space wars video game, features a full color monitor and is available in a 1 or 2 player upright or cocktail table model.

The player, controlling the Galaxian defenders of the Earth, must destroy a convoy of aliens that are

equally determined to annihilate him by firing missiles. The defender must protect himself without the aid of barricades. He must shoot down not only alien army regulars, but also out-maneuver and destroy enemy fighter escort ships that peel off from the main body of the alien squadron at random.

**Score:**

1 or 2 player. Maximum score: 999,990.

**High Score:**

Retained and displayed up to 6 digits.

**Defender Galax Ship:**

Moves freely across bottom of monitor firing missiles at aliens.

**Reserve Galax Ships:**

Number of player-up remaining ships clearly indicated.

**Credit Line:**

Maximum 9 credits per player.

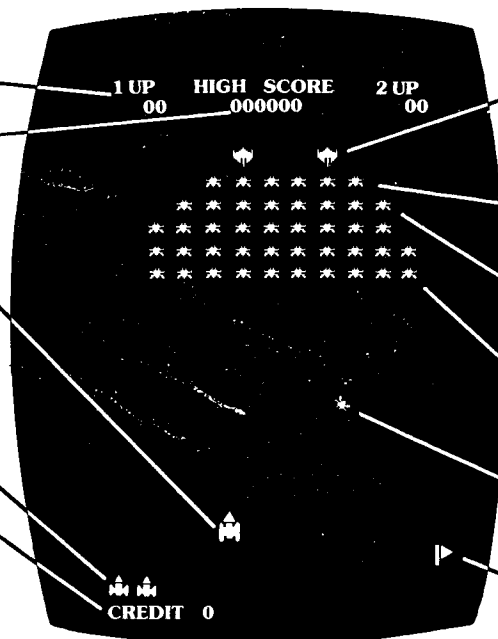

**ALIEN SHIPS' POINTS:**

**Flagship:** 60 points each. 150, 200, 300 and 800 bonus points when hit while attacking.

**Red Alien:** 50 points each. 100 bonus points for hits while attacking.

**Purple Alien:** 40 points each. 80 bonus points for hits when attacking.

**Green Alien:** 30 points each. 60 bonus points when attacking.

**Alien Attacker Ships:** Double score for each ship shot down.

**Flag:** One awarded for each convoy destroyed.

**BONUS POINTS:**

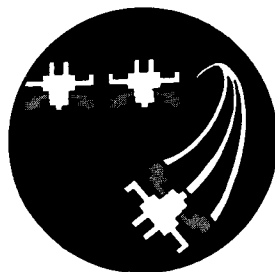

**Double Points:**

For lone green alien attacking at random.

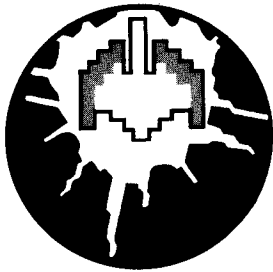

**150 Points:**

For hitting lone attacking flagship.

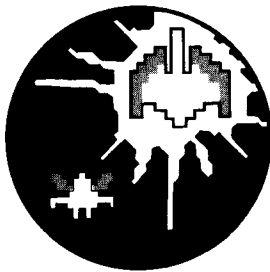

**200 Points:**

For hitting attacking flagship with single escort.

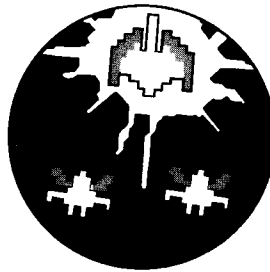

**300 Points:**

For hitting attacking flagship with two escorts.

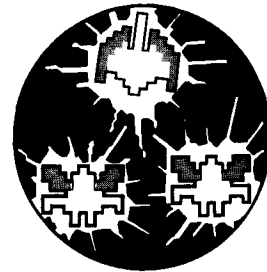

**Special 800 Points:**

For destroying fighter escort and flagship. (Escort ships must be hit first.)



**MIDWAY MFG. CO.**

A BALLY COMPANY  
10750 West Grand Avenue  
Franklin Park, IL 60131  
Phone: (312) 451-1360

DISTRIBUTED BY:

## TABLE OF CONTENTS

	Page No.
Introduction	1
Assumption - Video Probe Assembly	3
Flow Chart	5
Case A-Bad Power Supply	6
Case B-No Video	6
Case C-Bad Menu	8
Case D-Test	8
Case D1-Sound	10
Illustrations of Problems and Possible Solutions	13
Appendix	20
IC Function List	21
Component Layout	23
Logic Terms	24
Logic Terms Z-80	28
Service Bulletins	30
Schematics	33

## **INTRODUCTION**

Midway's new game, Galaxian, promises to be one of the hottest new games on the market today. As with any high production product, there will be a need for servicing from time to time. Therefore, since necessity is the mother of invention, this manual is being written to satisfy that need and to simplify troubleshooting.

The game itself is a highly complex system, but with a few basic tools all but the most difficult problems can be solved. This manual will show you how to track down the most common problems and show you how to fix them. It does not in any way explain how the board works, as that could conceivably run into volumes of text.

So use this manual to its fullest potential, GOOD LUCK!

## NOTES

THIS SPACE IS PROVIDED FOR PERSONAL NOTES

## ASSUMPTION

It is assumed throughout this manual that the board in question was once a working board; that is, there are no shorts, open lines or wrong parts. However, there may be isolated cases where such a condition occurred during normal use. These conditions, although rare, will be discussed where appropriate.

It is also assumed that the service person has the following:

- 1) AVOM or facsimile
- 2) A double clip lead ie, a jumper cable
- 3) A "Video Probe" assembled as follows

### VIDEO PROBE ASSEMBLY

- 1) Use a piece of insulated stranded wire AWG 16 or smaller.
- 2) Solder a 470 ohm resistor to one end and tape the connection for insulation.
- 3) Solder a miniature clip to the other end and tape as in step 2.
- 4) Check completed video probe for solidity.

### VIDEO PROBE USE

- 1) Connect clip of video probe to R59 between R62 and ground.
- 2) Test probe by touching resistor lead on probe to +5v.
- 3) A bright green block should be seen in the middle of the screen surrounded by a dimmer green border.
- 4) Probe is now functioning and ready to use.

It should be mentioned here that the video probe, although useful in many cases, is not a replacement for a 50Mhz oscilloscope. Whereas, it will show the presence or absence of certain signals, it will not always detect wrong signals without a little practice in identifying the wrong ones.

Therefore, if possible, it is recommended that you check the signals shown here before the board fails, to familiarize yourself with the proper responses to signals of your own video probe.

# FLOW CHART OF TROUBLESHOOTING PROCEDURE

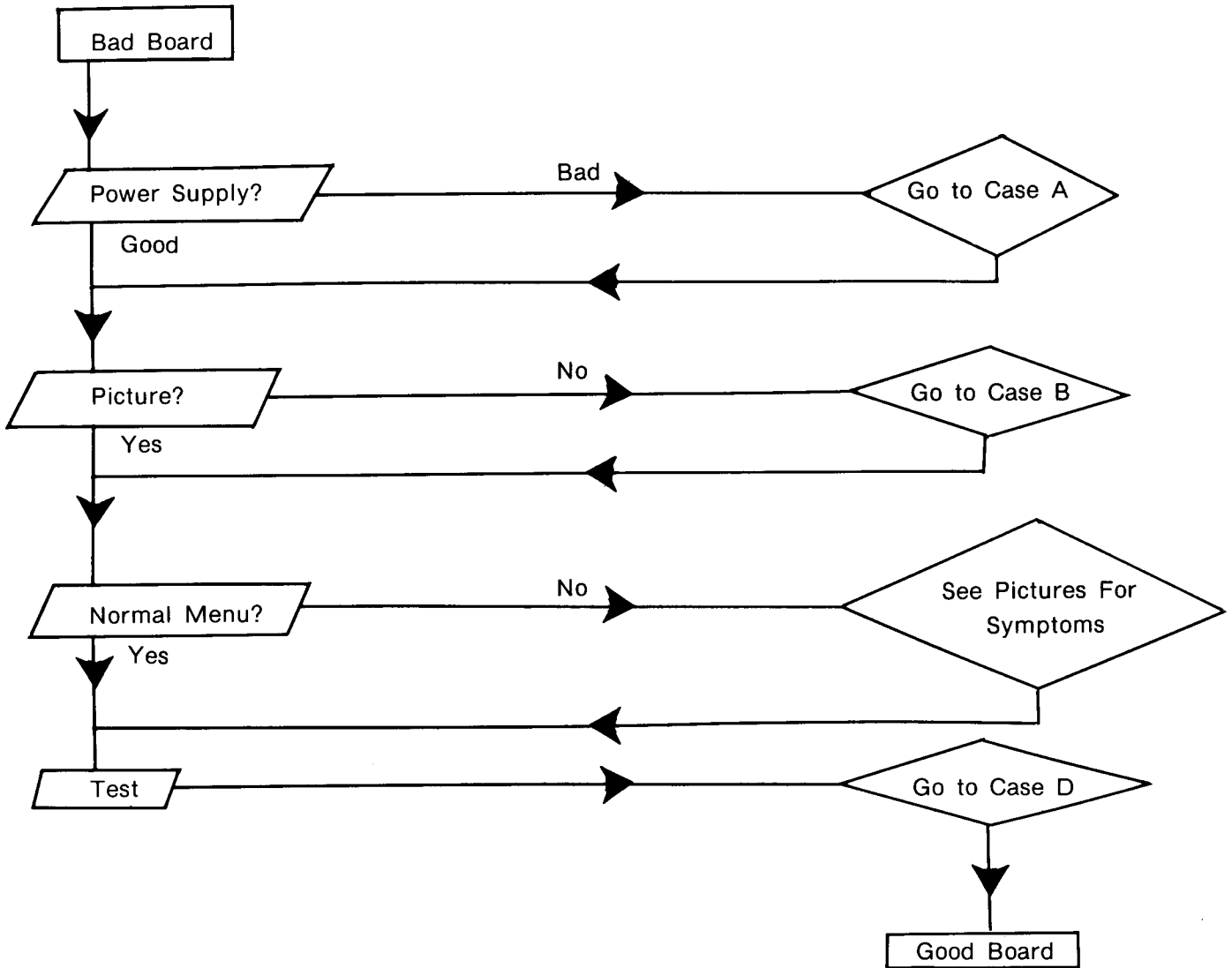

### CASE A-BAD POWER SUPPLY

The power supply on the Galaxian game board is relatively simple to troubleshoot and repair.

- 1) Disconnect the +5v jumper located next to the two A14F diodes D6 & D7.
- 2) With the power off, check both sets of diodes with an ohm-meter for short or open condition. If a diode is found to be faulty, replace it.
- 3) If diodes check out, check the two 10,000uf capacitors for shorts to ground.

If the board is OK up to here, the problem is probably with the D44VM4 and the UA78GU1C. Replace both if found to be faulty. Turn the power on and measure +7v from one side of the jumper to ground. If +7v is not measured, replace the 1N4736 (D8) zener diode. Reconnect the jumper and turn on the power. The board should be functioning properly.

### CASE B-NO VIDEO

In the case of no video, it is assumed that the board was once a working board, the power supply is working, there are no stars or "garbage" on the screen

First, with the video probe previously described, check the 74LS161's located at 3A,4A,5A, and 6A. You should observe horizontal lines on the pins of 3A and 4A that become more numerous and thinner as the probe is moved from pin 11 to pin 14 on each chip. If there are none on 3A, replace the 18 Mhz crystal and after that the 74368 at 1E. On pins 11 to 14 5A and 6A, you should see vertical lines in the same fashion as 3A and, 4A. See ILLUSTRATIONS chapter.

If the lines do not appear on any of the output pins on 3A,4A,5A, & 6A cut the pin and check with Video Probe. The lines will appear if the 74LS161 is good. If the lines are missing change the 74LS161.

If these chips are found to be OK, the next step is to check the Xor gates located at 3B, 4B, 5B, and 6B. This is done in the same manner as the 74LS161's just discussed. Figure 1 shows the entire section with the Xor gates on the outputs. The inputs of these chips should resemble the outputs. If they do not, cut the pin and check the line and the pin. If the pin is OK, reconnect the first pin cut, then cut any pin connected to that line until the line looks right again. Replace faulty part.



FIG.1. SECTION SHOWING 1C 7416Is & 7486s

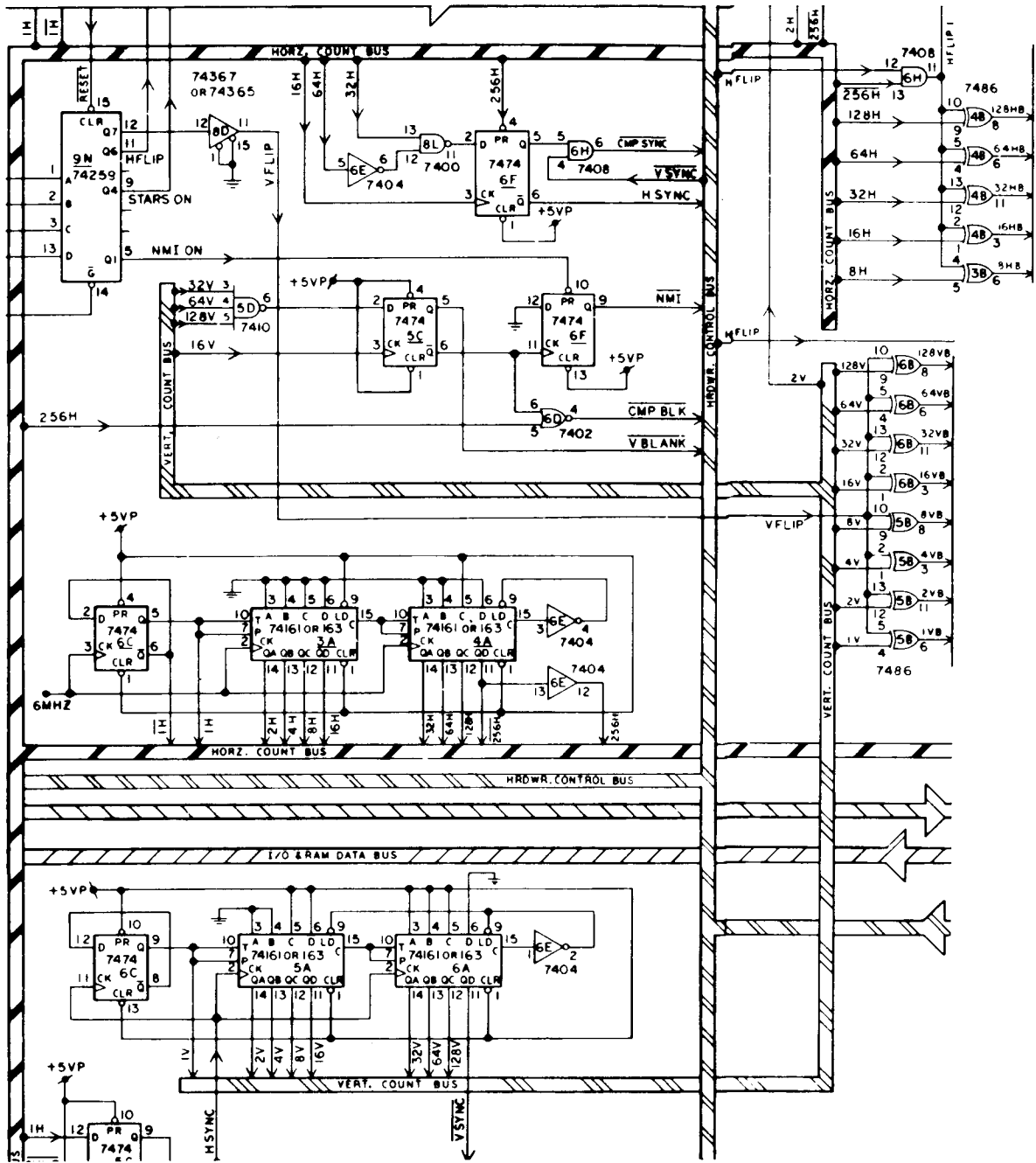

If the problem hasn't been remedied by this time, it may be a difficult and involved one. See ILLUSTRATIONS of video probe data for CPU ADDRESS and DATA , and compare them with your findings. Also, try replacing the memory board and CPU to be sure they are not the cause of the problem.

### CASE C-BAD MENU

The "MENU" in the case of Galaxian may also be called the "Skill" or "Attract" mode. That is, the game "plays itself" to attract players. It starts with "1 UP" and "High Score" at the top with "00" under each. "GAME OVER" appears on the lower 1/3 of the screen and "CREDIT 0" in the lower left corner. It then prints the Galaxian's mission and score advance table with the "CHARGER" scores flashing. Then it plays a short game and repeats.

Many of the problems present in the game, except sound, can be observed and/or repaired in this mode. See other sections for specific problems and solutions.

### CASE D-TEST

#### SEE PARTS AND OPERATION INSTRUCTION MANUAL SUPPLIED WITH GAME FOR COMPLETE TEST PROCEDURE

This section deals with the switches on the front panel and coin switches.

If any switches (left, right, fire, etc.) fail to work or emit a game noise during test mode, procede as follows:

- 1) Clean contacts on faulty switch with a stiff pen eraser.
- 2) With an ohm meter, check the wire from the switch to the game board for continuity.
- 3) Check the corresponding resistor and .1uf capacitor for proper value.
- 4) If the capacitor proves to be faulty, replace it.
- 5) If there is no problem here, change the corresponding 74LS368, according to Fig. 2.

The sounds corresponding to switches are given in table 1.

TABLE 1—SOUNDS & SWITCHES

SWITCH	
Left-right	Alien hit
Fire	Missile sound
Player 1-2 start	Yellow attacker hit
Coin 1-2	Coin sound

FIG. #2 SECTION SHOWING 74368s

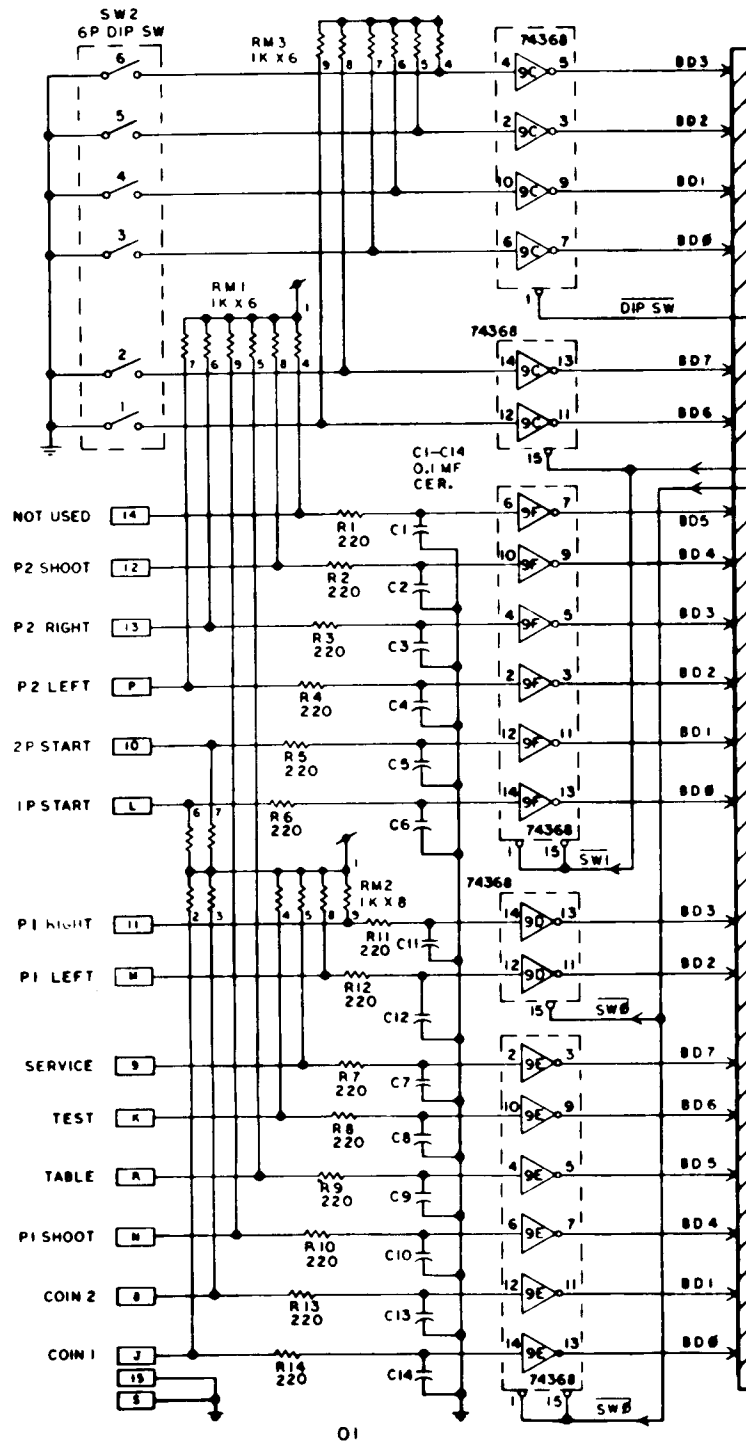

01

FIG. #2

## CASE D1-SOUND

There should be very few sound problems, but if encountered they are easy to fix using an ohm meter and a jumper to +5v. Most often the problems will be no sound, distorted sound and/or hum. In all cases, replace the .1uf capacitor located next to the LM 377 at 11A. If this doesn't clear it up, replace the LM377 and its heat sink. (.1uf capacitor C46)

All but two of the sounds can be checked in the test mode. The sounds not tested are explosion and background noise (rack movement).

### BAD EXPLOSION

To check the explosion in the test mode use a jumper to +5v and touch pin 7 of IC9L. This will cause the sound to remain on until the board is reset or placed in the game mode. If no explosion sounds, touch the anode side of D1 with the jumper. If explosion does sound, check R89 for continuity. If found to be faulty, replace it. If good, replace D1. If still no explosion, place video probe on one side of R40. "Noisy" or "dancing" green bars should be seen on the side away from pin 1 of IC7T. If not, replace LM 324 at 7T.

### BACKGROUND NOISE (RACK MOVEMENT)

The background noises can be checked individually in the test mode by touching the +5v jumper to pin 4 of IC's NE555 at 8R, 8S and 8T. If any one is bad or missing, replace C17, C18, or C19 respectively. If this doesn't work, replace faulty NE555. If all sounds are present but don't oscillate, replace both Q1 and Q2, GE6015 transistors.

### FIRE

The fire or missile sound if missing, can usually be fixed by replacing C26, or .01uf mylar capacitor. If not, place video probe on pin 5 of IC7T, press fire button twice rapidly and hold it in. Check screen for faint "DANCING" lines. If they are on pin 5 and not brighter on pins 6 and 7, replace bad LM 324.

### OTHER SOUNDS

All other sounds are generated by the IC74LS273 at 9J, the two IC74LS161's at 8K and 9K, and the IC74LS393 at 6T as seen in figure 3. Most often these will be indicated if the sounds are "jumbled." There may be a "hissing" noise in the sound which is usually remedied by changing the 470uf capacitor, C37, next to the power supply.

## OTHER SOUNDS (CON'T)

To troubleshoot the sounds generated by 9J, 8K, and 9K, check the outputs of 9J with the video probe. When normal, an output will display a solid green block in the middle of the screen. When a switch is closed, it will flash off and on. This is true of all outputs from 9J.

If any one output does not flash, cut the pin and check the pin and the line. If the pin produces a flashing box, change the corresponding IC74LS161. If not, 9J is bad and should be replaced.

Only one output is used from the IC74LS161's, eg pin 15. If nothing is flashing on pin 15 of 8K, check pin 15 of 9K and replace 9K if found to be faulty. When all is normal up to pin 8 of 6E, and the sound is still not good, check pins 6 and 13 of 7R. When normal, pin 6 should slightly dimm the color when using the video probe. Pin 13 should put a solid green block on the screen for the duration of the sound, then dim the color. If this is not the case, cut the pin and check the line. If found to be OK, check the pin on the IC74LS259 at 9L. If the pin on 9L is OK, replace the bad 4066 at 7R. If the pin is bad, replace the bad IC74LS259 at 9L.

**FIG. #3 SECTION SHOWING 74161s, 74393 & 74273**

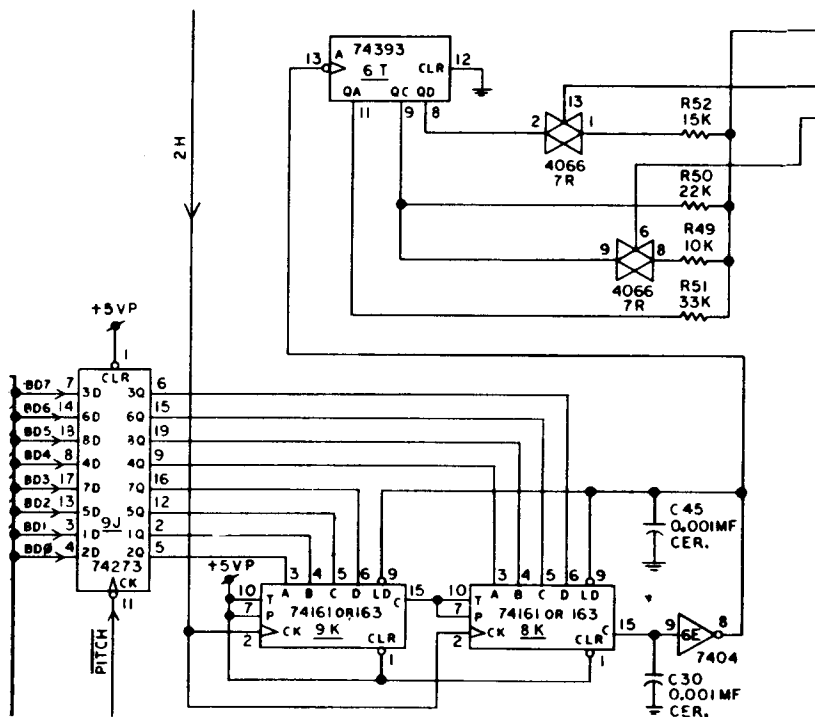

## NOTES

THIS SPACE IS PROVIDED FOR PERSONAL NOTES

## ILLUSTRATIONS

This chapter deals with some symptoms of bad video and shows some of the typical responses of the video probe.

Figure 1 shows the MENU with the reset button held in. You will notice the lack of stars and "charger" point values. The missing stars are normal with the reset button held in. Since the "charger" points flash on and off, they are missing only because the button was pushed when they were off.

Figures 2 through 16 show the 8 basic types of data as seen by the video probe. As can be seen in Fig. 2, 3 and 4, the VB signals start out wide and few and get thinner and more numerous as the probe is moved from pi 12 to 14 of IC5A and IC6A. The above description applies to Figures 6, 7, and 8, substituting HB signals with VB signals and IC3A and IC4A with IC's 5A and 6A.

Figure 9 shows a typical output of the IC74LS273 located at 2M. When the game is running in the skill mode, you will notice the movement of the green bars with the rack and the Galaxip. Depending upon the output selected, the bars will be of different sizes.

Figure 10 shows a typical output of one of the outputs of the IC74LS283's located at 4N and 5N. As can be seen in the schematic, their outputs go to the inputs of the IC74LS273 at 2M and are changed to resemble the outputs shown in Fig. 9.

Figure 11 shows a typical H-Position signal. These should all look about the same but flicker at different rates.

VRAM DATA, as seen in Figure 12 will put isolated squares and rectangles on different parts of the screen. All but the one seen on pin 12 of 3F will put green squares on the screen and leave the background normal. Pin 12 of 3F will make the background green and put blank squares on the screen.

BD DATA is shown in Fig. 13. These should look similar to each other.

Figures 14 and 15 show CPU ADDRESS lines of different frequencies. You shouldn't have to check these very often, but it may help to see what they look like. This holds true for Fig. 16 as well.

## VIDEO ILLUSTRATIONS

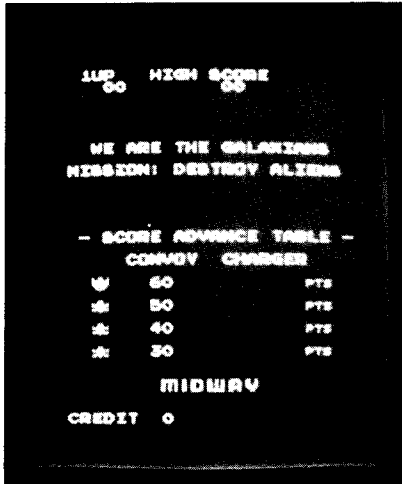

Fig. 1 Normal Menu with reset button held in.

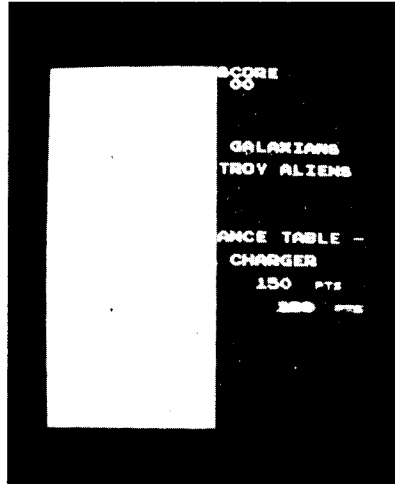

Fig. 2 Normal VB as seen with the video probe on pin 12 of IC6A

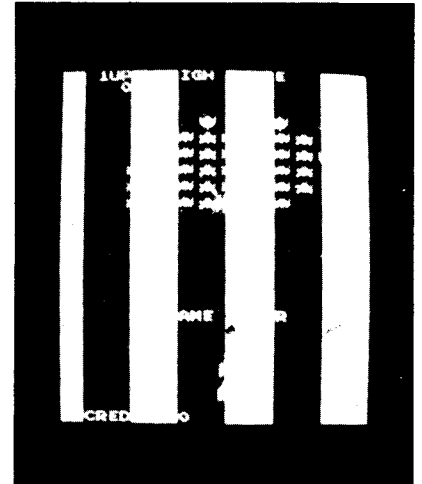

Fig. 3 Normal VB as seen with the video probe on pin 14 of IC6A.

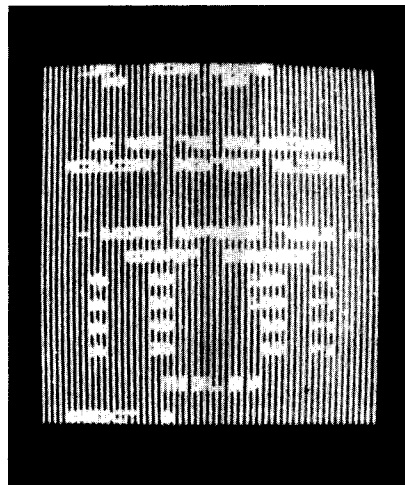

Fig. 4 Normal VB as seen with video probe on pin 14 of IC5A

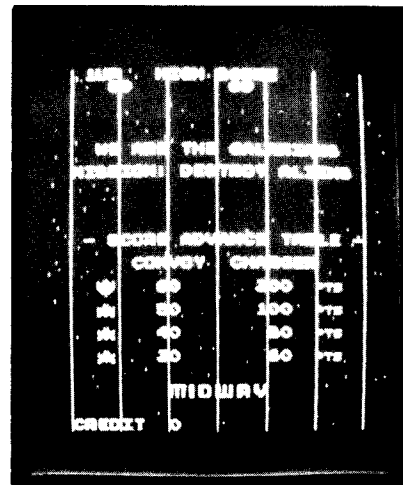

Fig. 5 Normal enable of VB counters as seen with video probe on pin 15 of IC5A and pin 10 of IC6A.



## VIDEO ILLUSTRATIONS

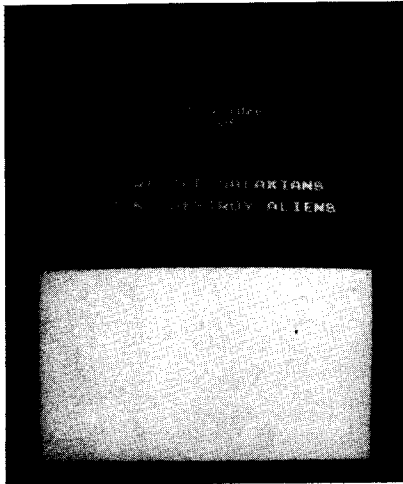

Fig. 6 Normal HB as seen with video probe on pin 12 of IC4A.

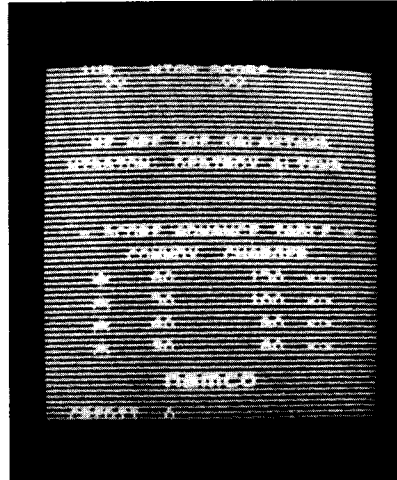

Fig. 7 Normal HB as seen with video probe on pin 14 of IC3A.

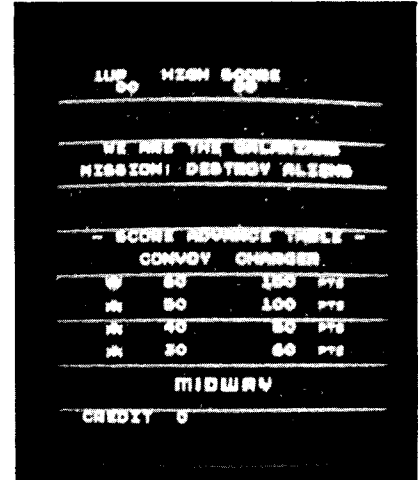

Fig. 8 Normal enable signal for HB counters as seen with video probe on pin 15 of IC3A and pin 10 of Fig. 4A.

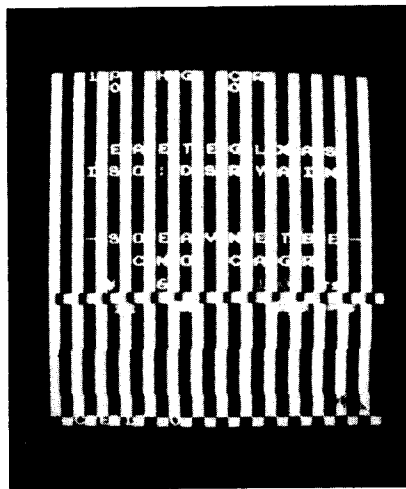

Fig. 9 Normal output of 74LS273 pin 19 of IC2M.

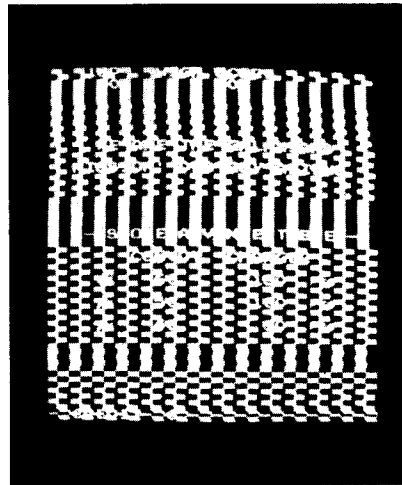

Fig. 10 Normal output of 74LS283 pin 10 of IC5N

## VIDEO ILLUSTRATIONS

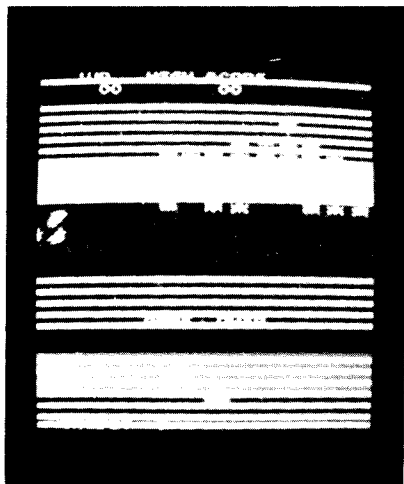

Fig. 11 Typical H POSI. data as seen with the video probe.



Fig. 12 Typical Vram data.

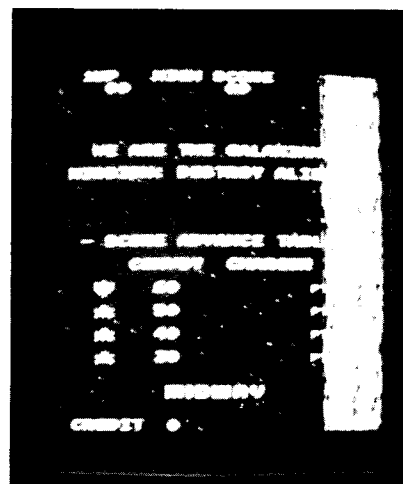

Fig. 13 Typical BD data.

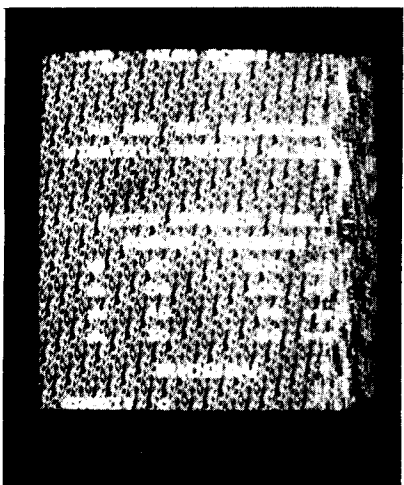

Fig. 14 Typical CPU address signal.

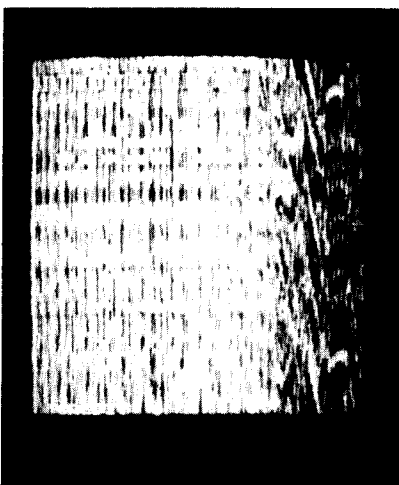

Fig. 15 another type of CPU address.

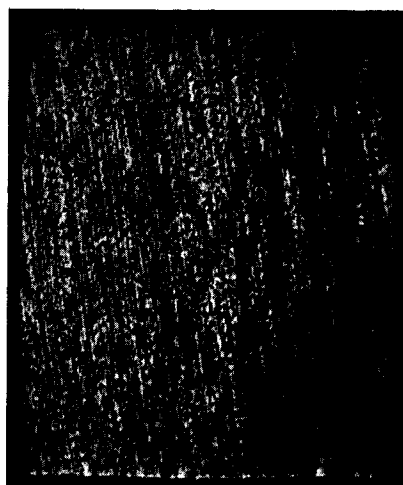

Fig. 16 Typical CPU data.

## VIDEO ILLUSTRATIONS

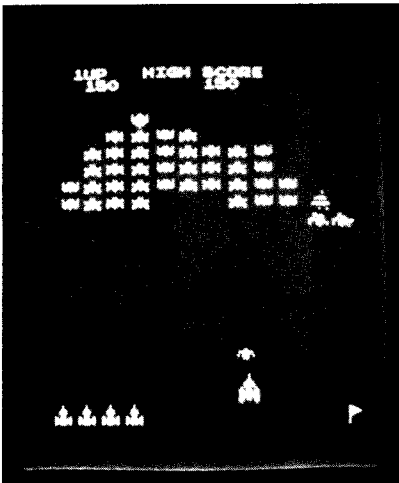

Fig. 17 Missing address on attack Ram. Note - the lines and distortion on divers. (27LS00)

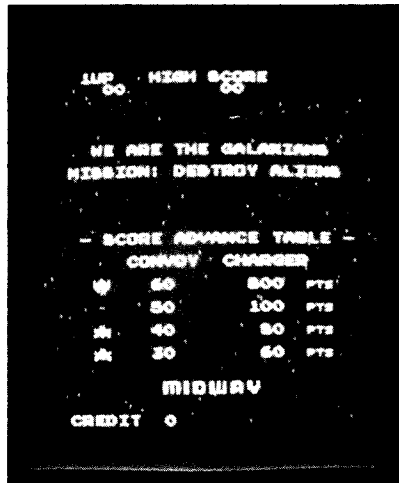

Fig. 18 Bad attack Ram 1S.

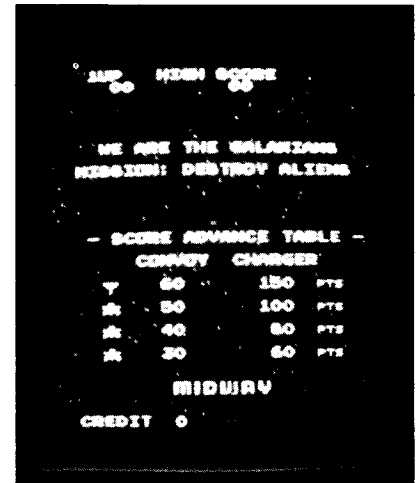

Fig. 19 Bad attack Ram 1R.

Figure 17 shows what usually happens when an attack Ram goes bad. When the aliens dive, there may be colored or just black lines through the attackers. When lines appear, it is a symptom of a missing address line within the Ram. Therefore, the bad line may not appear to be bad when viewed with the video probe.

### TROUBLE SHOOTING BAD ATTACK RAMS IS DONE AS FOLLOWS:

- 1) Connect jumper cable to +5v.
- 2) Touch Pin 6 of each attack Ram and watch divers.
- 3) You will notice one attacker disappears or all attackers look distorted.
- 4) Whichever Ram makes the lines go away when touched to +5v is the defective Ram.
- 5) If socketed, double check by pulling out suspected Ram.
- 6) Replace if found to be faulty.

Figures 18 and 19 also show symptoms of a bad attack Ram. They also show what happens when the technique listed above is used for 2 of the attack Rams. See No. 3 Above.

Figure 20 shows a typical reaction to a bad output from IC4L, a 74LS273. When the attackers dive, they may turn into many different and definitely wrong characters such as parts of an explosion, red Galaxip or numbers and letters as shown here.

Figures 21 and 22 illustrate symptoms of a bad RAM 3 (IC2101 at 4F and 5F). This problem is probably the most common one you will come across. It can be described as “Breaking Up” of all movement in the rack and Galaxip. Figure 21 best shows what happens when IC5F is bad. Note the wrong letters and the small line next to the moving alien (to the right of the “30”). Figure 22 shows the “Breaking Up” of video. This usually points to IC4F, however, both IC2101’s can cause either symptom.

Sometimes a bad IC2101 is indicated if the shells from the Galaxip flicker when an attacker is in the air. Also, when a shell is fired and the “High Score” moves rapidly to the right.

Other symptoms of a bad RAM 3 include, parts of aliens missing, distorted aliens after warm up, flickering aliens, distorted letters, distortion on explosion and “BAD RAM 3” on screen. If these RAMS are in sockets and any of these symptoms appear, replace the RAMS one at a time until it is cleared up. If it proves not to be a bad RAM and the motion is still breaking up, use the video probe in the following manner:

- 1) Place probe on the outputs of the IC74LS273 located at 2M.
- 2) Push reset button and wait for screen to clear.
- 3) Observe the motion and watch for any inconsistency of motion.
- 4) When inconsistency of motion is found, check the input for the same inconsistency.
- 5) If the input is OK, replace the IC74LS273.
- 6) If the input is bad, replace the corresponding IC74LS283 at 4N or 5N according to the schematic.

Figure 23 is an extreme case of bad RAM 2 ie missing pin 13 at IC 3F. Usually the board will just read, “BAD RAM 2” on the screen. If this is the case, replace IC2114’s at 3F and 3H, or 9B & 5J.

Figure 24 shows a rare case of no sync. Proceed as follows:

- 1) Follow the line back from R65 to pin 6 of IC6H for breaks.
- 2) If none, clean contacts on board with a stiff pen eraser.

If that doesn’t work, replace IC6H.

Figure 25 shows an input to the RAMS at 3F and 3H. It looks like fig. 9 except for the Address visible along the bottom. It is an output from a 74LS157 multiplexer located at 3E. This IC “adds” the outputs from the 74LS273 at 2M and CPU ADDRESS to supply “VRA” Address to the IC2114 RAMS at 3F and 3H.

## VIDEO ILLUSTRATIONS

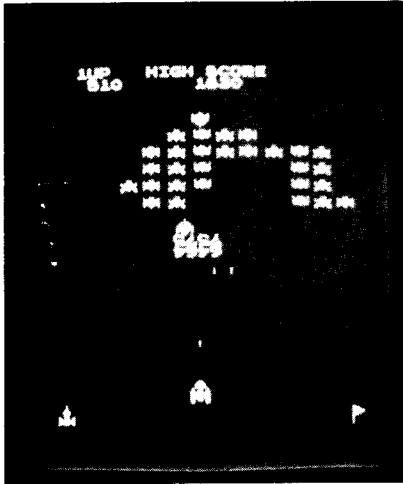

Fig. 20 Typical of bad output on IC4L.

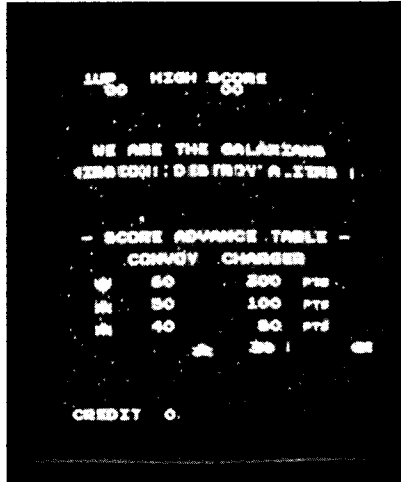

Fig. 21 Typical symptom of a bad RAM 3.

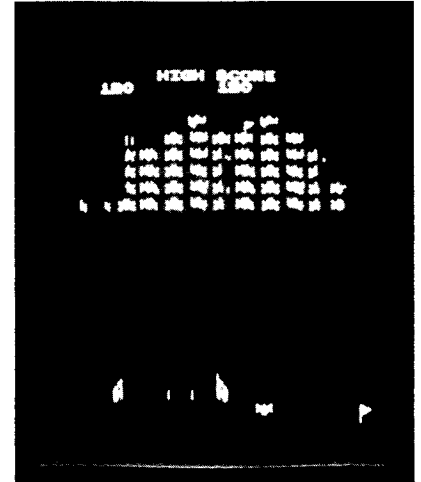

Fig. 22 Typical symptom of a bad RAM 3.

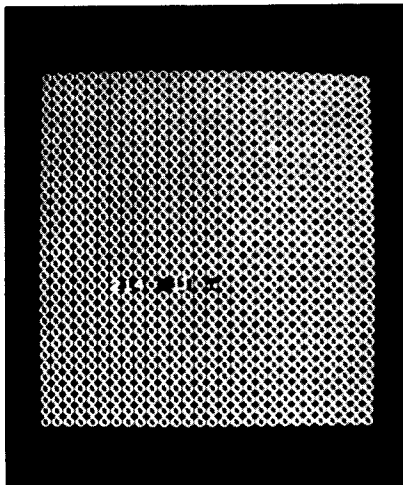

Fig. 23 Bad RAM 2

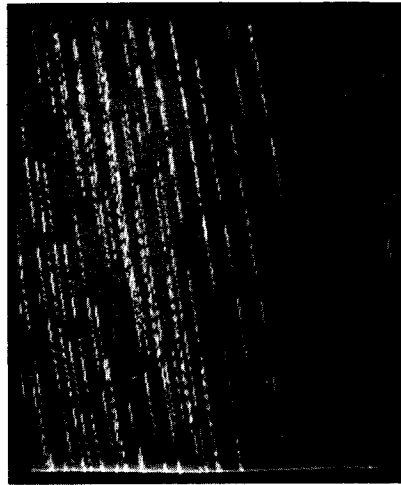

Fig. 24 No SYNC

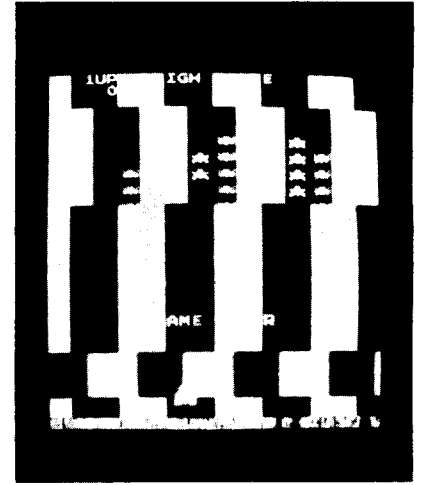

Fig. 25 Showing output data from IC5N and CPU address being multiplexed at pin 7 IC2F.

## APPENDIX

### QUICK REFERENCE OF PROBLEMS + SOLUTIONS

SYMPTOM	POSSIBLE SOLUTION	LOCATION
No Video	Power Supply	
Aliens Break Up*	2101	4F/5F
Picture Breaks Up	2101	4F/5F
Galaxip, Letters Break Up	2101	4F/5F
Stars Flash or are Missing	74LS164	1A/1B
Blows Fuses	Power Supply	
Lines in Picture (Colored or Black)	27LS00, 93411, 82516 +	1N-1T
Lines through Attackers	27LS00, 93411, 82516 +	1N-1T
Bad Ram 2 on Screen	74C245**	9B/5J**
Bad Rom on Screen	Rom Card	7F-7L
Tilts Itself (Resets)	Rom Card	7F-7L
Garbage on Screen	Rom Card	7F-7L
No Sound	1877,.1 uf Cap. (LM 377)	11A, C26

The table above shows some of the most common problems and probable trouble areas. Use this table for quick fixes and reference to problem areas only.

\* SEE ILLUSTRATIONS

+ All the same type of part located at 1N-1T with heat sinks glued on.

\*\*74C245 is a Bi-Directional bus driver. Some boards have 2-8216's as bus drivers. In this case, the problem probably lies somewhere else.

## GALAXIAN LOGIC BOARD

CHIP NUMBER	FUNCTION
74LS00	Quad Two Input Nand
74LS02	Quad Two Input Nor
7404	Hex Inverter
74LS08	Quad Two Input And
74LS10	Triple Three Input Nand
74LS20	Dual Four Input Nand
74LS30	Eight Input Nand
74LS32	Quad Two Input Or
74LS74	Dual "D" Flip-Flop
74LS86	Quad Two Input Exclusive Or
74LS107	Dual "JK" Flip-Flop
74LS138	Three to Eight Line Decoder
74LS139	Dual Two to Four Line Decoder
74LS157	Quad Two Input Multiplexer
74LS161	Four Bit Counter
74LS163	Four Bit Counter
74LS164	Eight Bit Shift Register
74LS174	Hex "D" Flip-Flop
74LS175	Quad "D" Flip-Flop
74LS194	Eight Bit Shift Register
74LS259	Eight Bit Addressable Latch
74LS273	Octal "D" Flip-Flop
74LS283	Four Bit Binary Adder
74LS245	Octal Bus Transceiver
74LS366	Hex Bus Driver-Inverting
74LS367	Hex Bus Driver
74LS368	Hex Bus Driver-Inverting
74LS377	Octal "D" Flipflop

## GALAXIAN LOGIC BOARD

CHIP NUMBER	FUNCTION
74LS393	Dual Four Bit Binary Counter
27LS00	Ram
2114	Ram
TMS4045	Ram
AM9124	Ram
2101-2	Ram
AM9101	Ram
8304	Bus Driver-Bidirectional
8216	Bus Driver-Bidirectional
LM324	Quad Operational Amp
555	Timer
LM377-1877	Audio Amp
Z80	CPU
2716	Prom-16K
1M5610-82LS123	Prom
78GUIC	Voltage Regulator
ULN2075	Quad Buffer
18.432	X-TAL
CD4066	Quad Electronic Switch
D44VM4 TIP-31	Transistor
GE6015	Transistor
MC14066	Quad Electronic Switch
GEA15F	Diode-Rectifier
A14F	Diode-Rectifier
IN4148	Diode-Rectifier
IN4736A	Diode-Zener
D2316EC-9316	16K Rom
D2364C	64K Rom



COMPONENT LAYOUT PART NO. M051-00866-8002  
 \* INDICATES 0.1MF, 50V AXIAL LEAD CERAMIC CAP

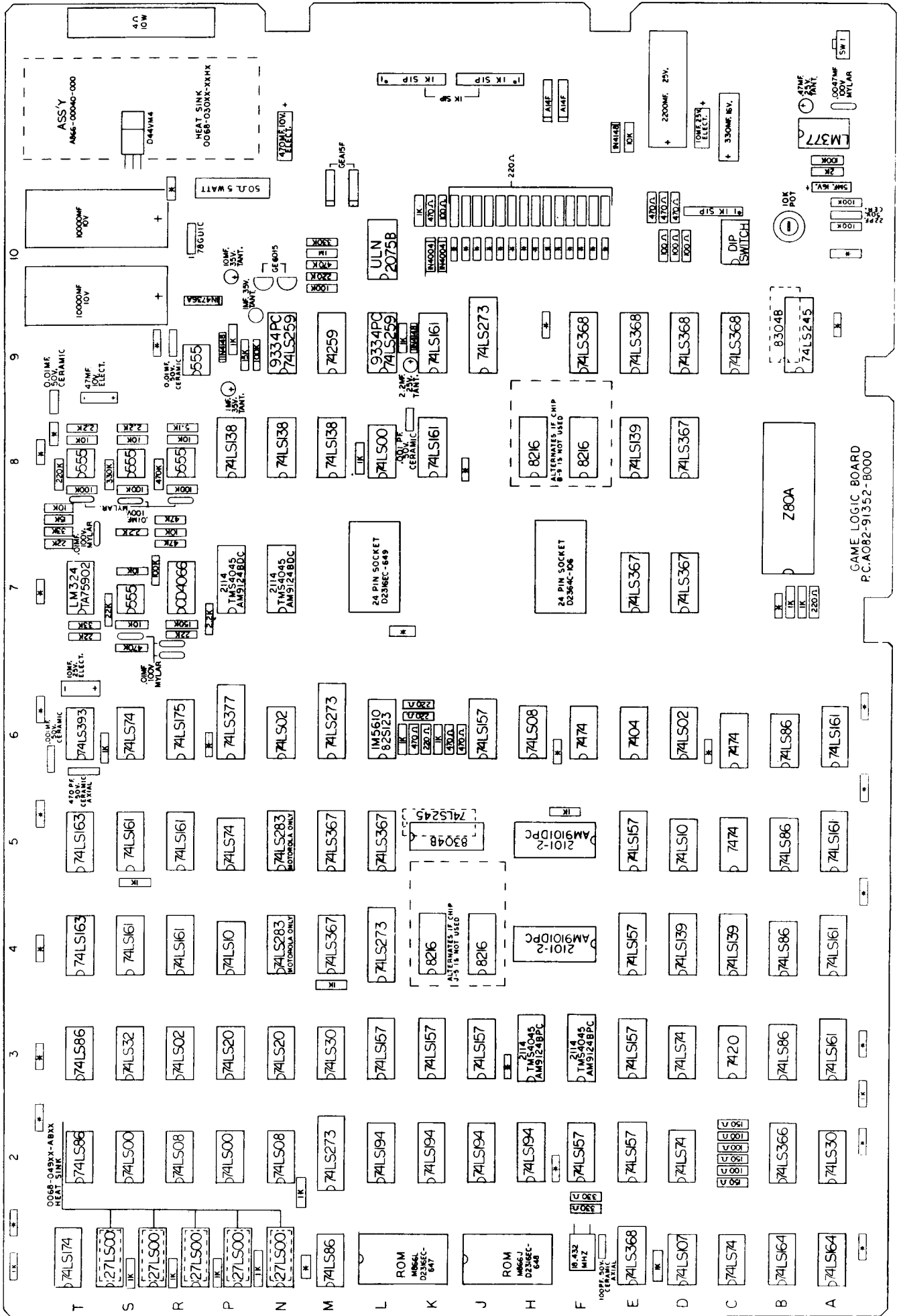

GAME LOGIC BOARD  
 P.C.A082-91352-8000

# GALAXIAN

## Logic Terms

PC A082-91352-B000

A	Address
Audio	Common line for all sounds except Explosion
Blue	Color
Green	Color
Red	Color
BD	Bidirectional Data
CMP SYNC	Composite Sync
CMP BLK	Composite Blanking
COL	Color
CS	Chip Select
CNTR CL	Counter Clear
CLR	Clear
CD	Color Data
Driver	Enable low sounds
D	Data
DIP SW	Switches on Logic Board
FS	Frequency Select
DI	Data In

# **GALAXIAN**

## **Logic Terms**

**PC A082 - 91352 - B000**

HIT	Explosion Sound
FIRE	Missile Sound
G	Gate (chip enable)
HPOS	Horizontal position
HFLIP	Horizontal Video flip
LBWE	Line Buffer write enable
LBA	Line Buffer Address
LSD	Least Significant Bit.
LD	Load
MLD	Missile Load
MSD	Most Significant Bit
MSLD	Missile Shell Load Data
MHZ	Megahertz
Missile	Player's Missile
NMION	Non Maskable interrupt on.
Noise	Sound noise for Missile and Explosion.
I&O	Input and Output
Pitch	Load High Pitch Sounds
PGM	Program
OBJ RAM WR	Object Ram Write
OBJ RAM RD	Object Ram Read
OBJ RAM	Object Ram

**GALAXIAN**  
**Logic Terms**  
**PC A082-91352-B000**

RAM RD	RamRead
Reset	Clears Memory
RA	Ram Address
RC	Raw Color
RV	Raw Video
RAW	Raw (Data)
RVIS	Raw Video Select High
RVOS	Raw Video Select Low
SLD	Shell Load
Sound	Enable all Sounds
Shell	Invader Shell
Stars	Video Stars
VPL	Vertical Position Load
VID	Video
VRA	Vertical Ram Address
VRCS	Vertical Ram Chip Select
VRAM	Vertical Ram Chip Select
VRAM RD	Vertical Ram Read
VRAM WR	Vertical Ram Write
V Blank	Vertical Blanking
V SYNC	Vertical Sync

# GALAXIAN

## Logic Terms

PC A082-91352-B000

H SYNC	Horizontal Sync
V RAM CS	Vertical Ram Chip Select
VOL	Volume
WE	Write Enable
WDR	Watchdog Driver
WEN	Write Enable
WREQ	Write Request    Write Enable

### Z-80 CPU PIN DESCRIPTION

The Z-80 CPU is packaged in an industry standard 40 pin Dual In-Line Package. The I/O pins are shown in figure 3.0-1 and the function of each is described below.

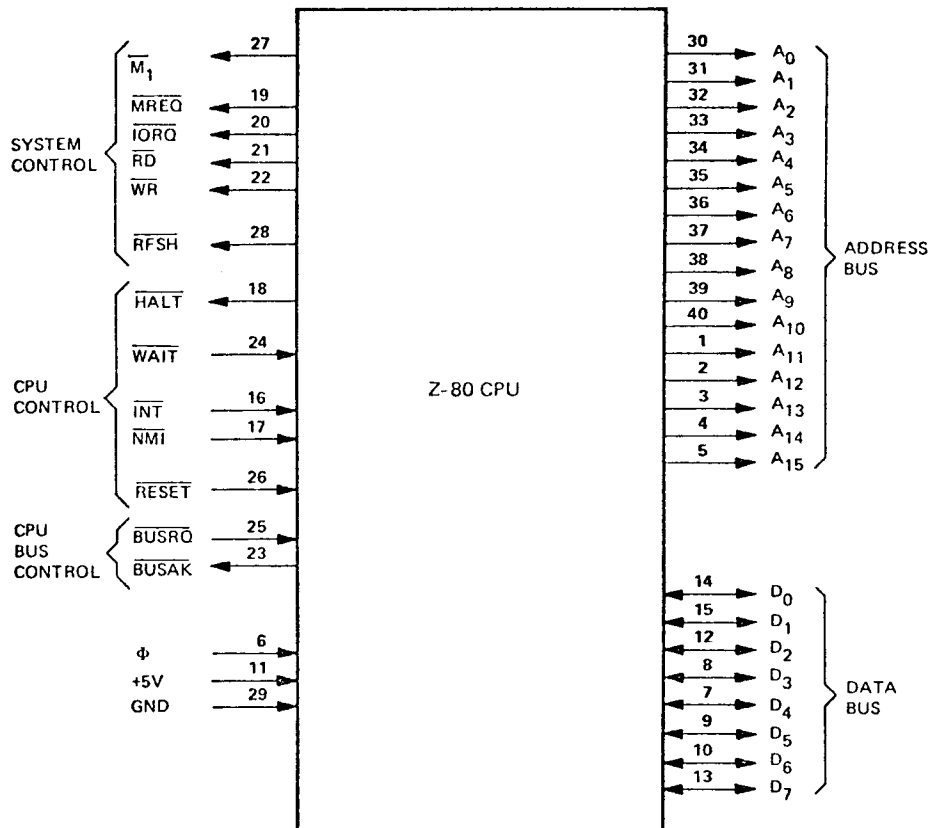

Z-80 PIN CONFIGURATION  
FIGURE 3.0-1

## LOGIC TERMS Z-80 SYSTEM

ADD	Address
AUDIN	Audio In
BUSAK	Bus Acknowledge
BUSRO	Bus Request
BUZOFF	External Control
B-Y	Blue Minus Video
BYTE	Has Four Pixels
CE	Chip Select
CAS	Column Address Strobe
CASEN	CAS Enable
D-O	Data Out
D-1	Data In
DATEN	Data Enable
I or Q	Input-Output Request
HD	Horizontal Drive (63.5 us)
INT	Interrupt Request
I & O	Input-Output Signals
LTCHDA	Latch Data
LITE PEN	Interrupt Control
MD	Memory Data
MA	Memory Address
M1	Machine Cycle One
MREQ	Memory Request
MUXD	Multiplex Data
MC	Micro Cycle Control
MENEN	Memory Enable

## LOGIC TERMS Z-80 SYSTEM

NMI	Non Maskable Interrupt
OG	Phi-G Clock
PX	Monitor Picture Clock
PIXEL	Smallest spot on color monitor screen with information
RAS	Row Address Strobe
RFSH	Refresh
RAMSEL	Ram Select
RD	Memory Read
R-Y	Red Minus Video
SYSEN	System Enable
SI	Signal In
SO	Signal Out
VD	Vertical Drive (16.6 MS)
VIDOT	Video Out
WE	Write
WRTCL	Write Control
WR	Memory Write
RESET	Normally high an. active low resets the Z-80

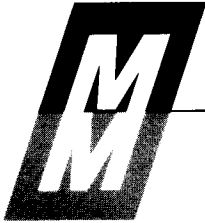

**MIDWAY MFG. CO.**  
A BALLY COMPANY  
10750 W. GRAND AVENUE • FRANKLIN PARK, ILL. 60131

PHONE: AREA CODE 312 451-1360

CHICAGO PHONE: 992-2250

### SERVICE BULLETIN

Game: Galaxian (As of Serial No. 11,500)

Subject: Rom program identification (3rd Program)

\*\*\*\*\*

1. The 3rd program change has new Bonus values. (see Figure #1)
2. New program identification (Game, Location and Program)  
M866 - U - 09S2  
M866 - V - 09S2  
M866 - W - 09S2  
M866 - Y - 09S2  
M866 - Z - 09S2
3. The 1st program version 09S0 and 2nd program version 09S1 can not mix with 3rd program 09S2.
4. The 1st and 2nd program has 2716 Proms and also 2716 Proms mixed with 9316 Roms.
5. If additional clarification is needed please call the service department.
6. New Program Bonus Values are as follows (Figure #1)

	sw 3	sw 4
Bonus Galaxip at 7,000 pts.	OFF	ON
Bonus Galaxip at 10,000 pts.	ON	OFF
Bonus Galaxip at 12,000 pts.	OFF	ON
Bonus Galaxip at 20,000 pts.	ON	OFF





**MIDWAY MFG. CO.**

A BALLY COMPANY

10750 W. GRAND AVENUE • FRANKLIN PARK, ILL. 60131

PHONE: AREA CODE 312 451-1360

CHICAGO PHONE: 992-2250

## SERVICE BULLETIN

### GALAXIAN LOGIC BOARD

\*\*\*\*\*

There are two (2) versions of the Galaxian Program.

They are:

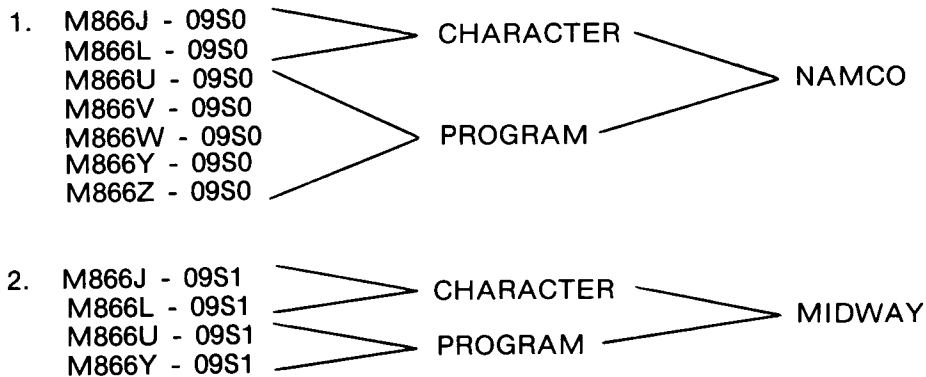

The Midway Roms and the Namco Roms Character Cannot be mixed. It will result in the super-imposing of the names in the attract mode of the game.

However the Midway and Namco Program can be mixed with one exception and that is the locations U & Y. If you use one you'll have to use the other or you'll get a Bad Rom read-out.

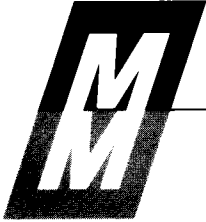

**MIDWAY MFG. CO.**

A BALLY COMPANY

10750 W. GRAND AVENUE • FRANKLIN PARK, ILL. 60131

PHONE: AREA CODE 312 451-1360

CHICAGO PHONE: 992-2250

## SERVICE BULLETIN

GAME: GALAXIAN

### TEST SLIDE SWITCH

Located in cash box area and is readily accessible by opening coin door. When placed in "on" position this switch initiates test mode.

### GAME BOARD TEST

If game board is good, the following information will be displayed on the screen:

OK

Coin Adjustment Setting

Bonus Adjustment Setting

No. of Galaxip Per Game Setting

### RAM/ROM TEST

If any of the Rams or Roms are faulty, the following information will be displayed on the screen:

"Bad Ram 1" — indicates bad Ram at location 7N or 7P.

"Bad Ram 2" — indicates bad Ram at location 3F or 3H.

"Bad Ram 3" — indicates bad Ram at location 4FH or 5FH.

"Bad Rom" — indicates bad Rom on memory board.

\*NOTE: Early models were not equipped with memory boards. In these models, "Bad Rom" indicates bad Rom at location 7F or 7H.

### CONTROL PANEL AND COIN SWITCH TEST

To verify operation of any switch, close switch in question. If the switch is operating properly, a game sound will emit when closure is made.

CAUTION: Be sure to return test switch to game mode when all tests are completed.

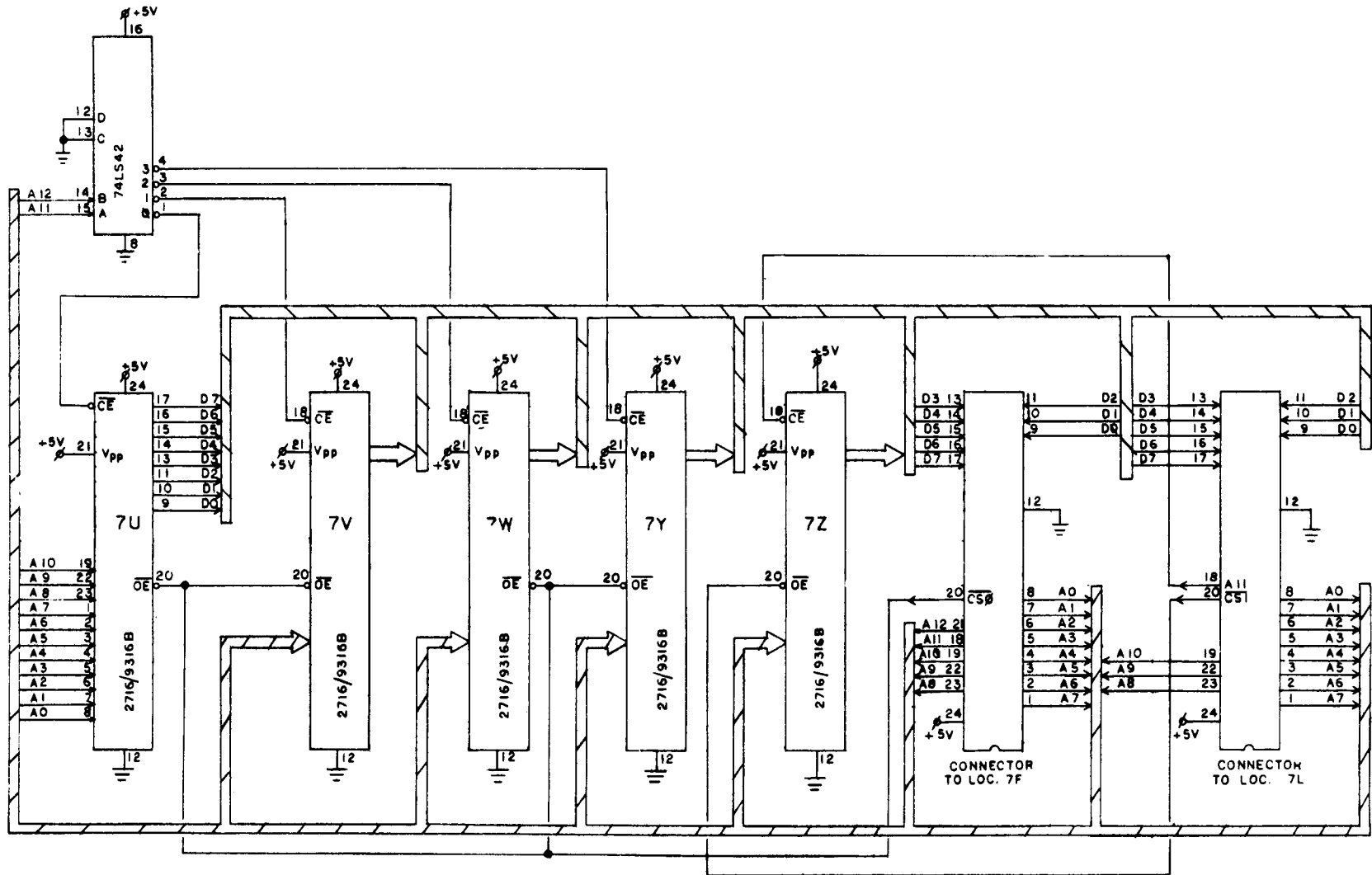

MEMORY LOGIC SCHEMATIC  
PART NO. M051-00866-A004

DO NOT SCALE DIMS.		HEAT TREAT	SEAL	USED ON GALAXIAN	REVISIONS
DIM. TOLERANCES UNLESS SPECIFIED		MATL.	NO. REQ'D 1	<b>MIDWAY MFG. CO.</b> FRANKLIN PK. ILL.	
CONDUCTIVITY T.R. 999	DRN. <i>AK</i>	FINISH	MEMORY BOARD CIRCUIT		PART NO. A082-91353-A866
FRACTURAL..... 1/16	CHD. <i>20</i>				
ORIENTAL..... 1/32	DATE <i>2/12/78</i>				

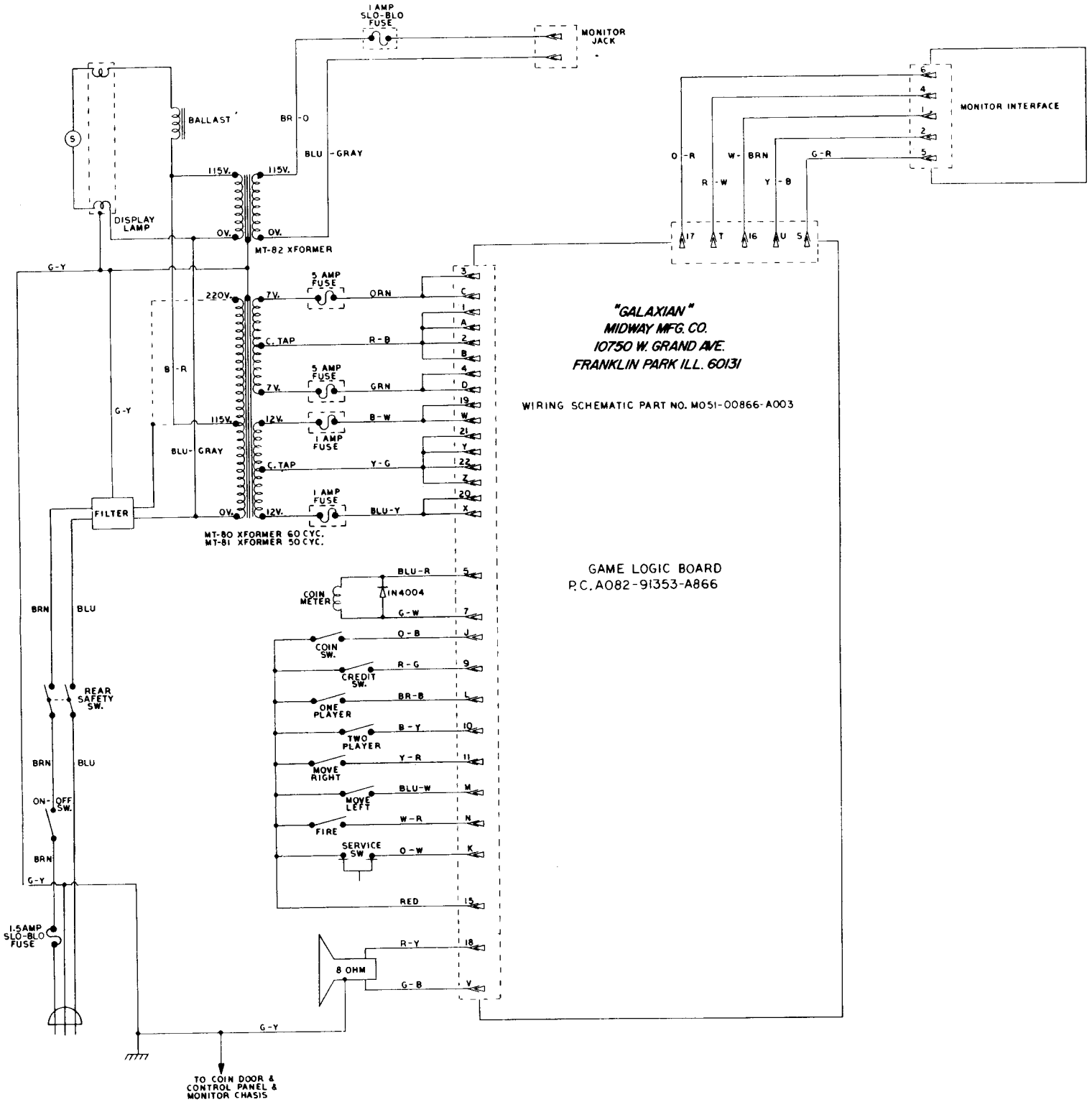

- NOTES:
1. 8 PULL-UP RESISTORS AND 28 DECOUPLE CAPACITORS ARE DISTRIBUTED OVER THE P.C. BOARD ASSY.
  2. ONLY 1 PC 74LS245, OR 1 PC 83048, OR 2 PC 82W ARE USED (AND STUFFED) FOR BI-DIRECTIONAL DRIVERS (1 BYTE OF DATA).
  3. SAME AS NOTE 2.
  4. SUBSTITUTION FOR THESE ROM'S IS MEMORY BRD. ASSY A084-91353-AR66
  5. ↑ INDICATES +5V

REV.	BY	ALL QJMF CER. CAR-#R. LEAD H2000	DATE
		DESC.	
MIDWAY MFG. CO. FRANKLIN PARK, ILL.			
DR.	G/ R1220	CRD.	
DATE	JAN, 1980	NO	REV 01
USED ON GALAXIAN			
LOGIC BOARD CIRCUITRY			
PART NO. A082-91352-A/0000			

LOGIC SCHEMATIC PART NO. M051-00866-A015

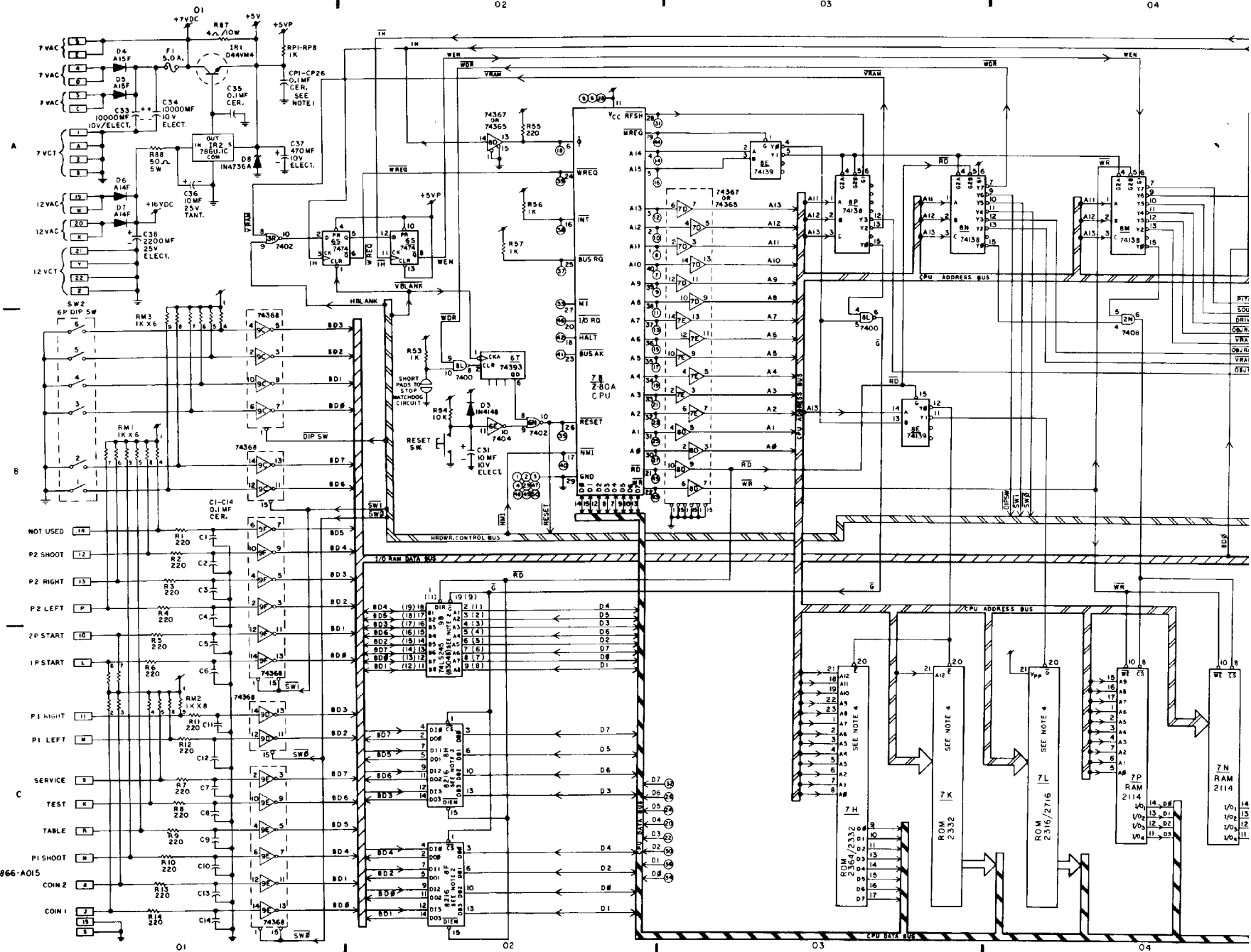

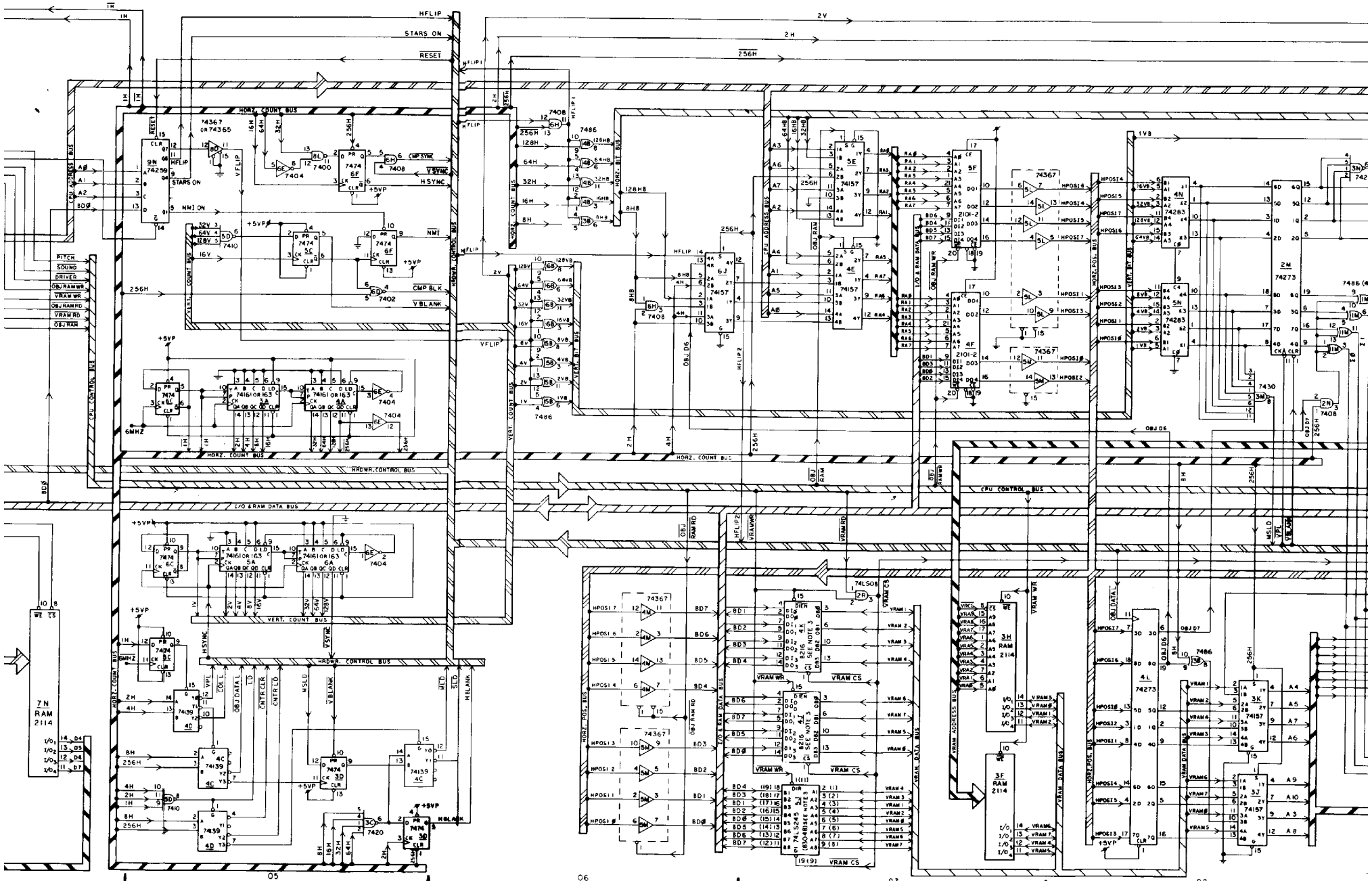

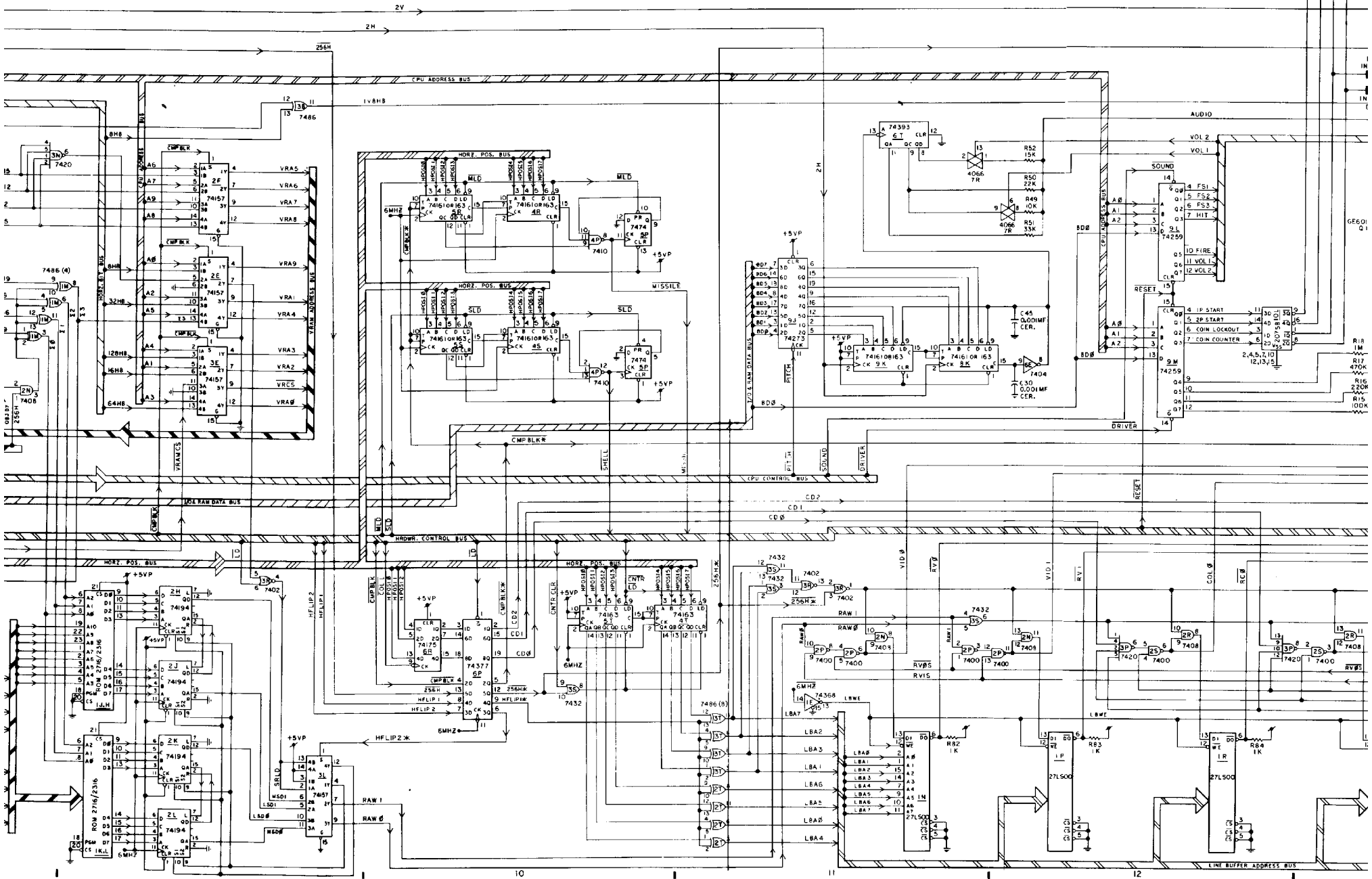

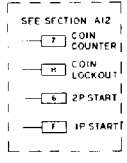
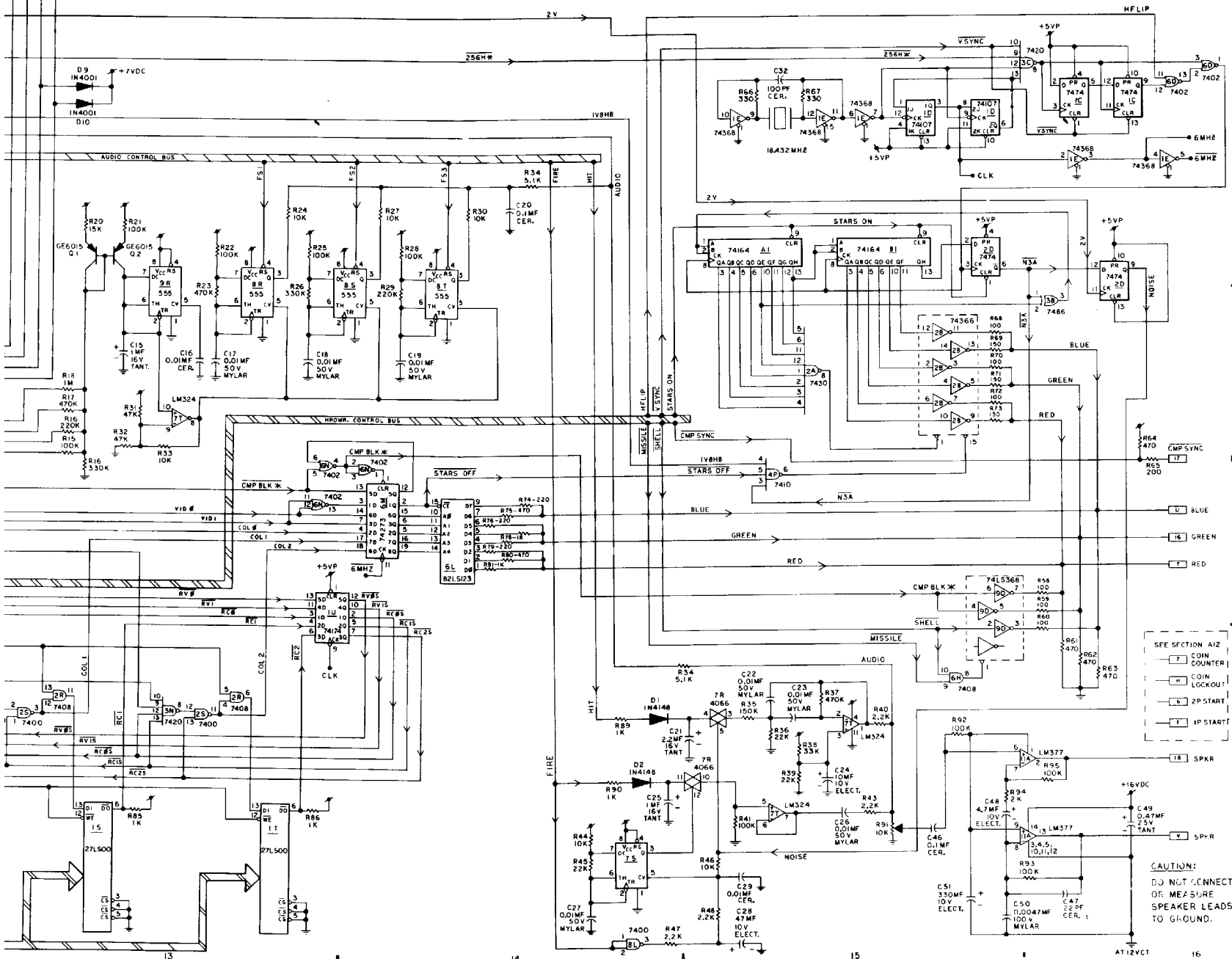

CAUTION:  
DO NOT CONNECT  
OR MEASURE  
SPEAKER LEADS  
TO GROUND.