

2ND PRINTING JAN '03

SEGA®

THE HOUSE OF THE DEAD™

Upright Version

Operators's Manual



SEGA AMUSEMENTS USA, INC.

MANUAL NO. 999-1668

VISIT OUR WEBSITE!

The screenshot shows a Mac OS X browser window displaying the SegaService.com website. The browser's address bar shows the URL <http://www.seuservice.com/>. The website's navigation menu on the left includes links for 'what's new', 'manuals', 'bulletins', 'assemblies', 'specials', 'Search', 'bulletin Sign-up', 'staff', 'Darl's Office', 'Return Policy', 'Warranty policy', 'corporate info', 'home page', 'plug-ins', and 'non-framed page'. The main content area features a large blue 'SEGA SERVICE' logo and a central advertisement for 'The NEW I/R Gun Protect Bd !!' with an image of a green circuit board and the text '(Click here for details)'. To the right of the logo is a list of site features: 'Bulletins', 'Darl's Office', 'Game Manuals', 'Search', and 'What's New'. Below the advertisement, a text block invites visitors to email Darl.Davidson@seu.sega.com for questions or comments. A 'POWERED BY Mac OS X' logo is displayed below the text. At the bottom, a row of links provides access to various site sections: [\[what's new\]](#), [\[manuals\]](#), [\[bulletins\]](#), [\[assemblies\]](#), [\[specials\]](#), [\[Search\]](#), [\[staff\]](#), [\[Darl's office\]](#), [\[Return/Parts Policy\]](#), [\[warranty\]](#), [\[corporate info\]](#), [\[plugins\]](#), and [\[Non-framed page\]](#). A message states, 'You will need the following items to view this page in its entirety.' Below this message are logos for 'Get Acrobat Reader' (All Platforms) and 'Get Microsoft Internet Explorer' (Windows and Macintosh). The browser's status bar at the bottom indicates 'Internet zone'.

BEFORE USING THE PRODUCT, BE SURE TO READ THE FOLLOWING:

To maintain the safety:

To ensure the safe usage of the product, be sure to read the following before using the product. The following instructions are intended for the users, operators and the personnel in charge of the operation of the product. After carefully reading and sufficiently understanding the warning displays and cautions, handle the product appropriately. Be sure to keep this manual nearby the product or elsewhere convenient for referring to it when necessary.

Herein, explanations which require special attention are enclosed with dual lines. Depending on the potentially hazardous degrees, the terms of WARNING, CAUTION, etc. are used. Be sure to understand the contents of the displays before reading the text.



Indicates that mishandling the product by disregarding this warning will cause a potentially hazardous situation which can result in death or serious injury.



Indicates that mishandling the product by disregarding this caution will cause a slight hazardous situation which can result in personal injury and or material damage.

For the safe usage of the product, the following pictographs are used:



Indicates “HANDLE WITH CARE.” In order to protect the human body an equipment, this display is attached to places where the Owner’s Manual and or Service Manual should be referred to.

- **Perform work in accordance with the instructions herein stated.**
Instructions for work are explained by paying attention to the aspect of accident prevention. Failing to perform work as per the instructions can cause accidents. In the case where only those who have technical expertise should perform the work to avoid hazardous situation, the instructions herein state that the serviceman should perform such work.
- **Be sure to turn off power before working on the machine.**
To prevent electric shock, be sure to turn off power before starting the work in which the worker touches the interior of the product. If the work is to be performed in the power-on status, the Instruction Manual herein always states to that effect.
- **Be sure to ground the Earth Terminal** (this, however, is not required in the case where a power cord with earth is used).
This product is equipped with the Earth Terminal. When installing the product, Connect the Earth Terminal to the “accurately grounded indoor earth terminal” by using an earth wire. Unless the product is grounded appropriately, the user can be subject to electric shock. After performing repair, etc. for the Control equipment, ensure that the Earth Wire is firmly connected to the Control equipment.
- **Ensure that the Power Supply used is equipped with an Earth Leakage Breaker.**
This product does not incorporate the Earth Leakage Breaker. Using a power supply which is not equipped with the Earth Leakage Breaker can cause a fire when earth leakage occurs.
- **Be sure to use fuses which meet the specified rating.** (only for the machines which use fuses).
Using fuses exceeding the specified rating can cause a fire and electric shock.

- **Specification changes (removal of equipment, conversion and addition) not designated by SEGA are not allowed.**
The parts of the product include warning labels for safety, covers for personal protection, etc. It is very hazardous to operate the product by removing parts and or modifying the circuits. Should doors, lids and protective parts be damaged or lost, refrain from operating the product, and contact where the product was purchased from or the office herein stated. SEGA shall not be held responsible for any accidents, compensation for damage to a third party, resulting from the specifications not designated by SEGA.
 - **Ensure that the product meets the requirements of appropriate Electrical Specifications.**
Before installing the product, check for Electrical Specifications. SEGA products have a nameplate on which Electrical Specifications are described. Ensure that the product is compatible with the power supply voltage and frequency requirements of the location. Using any Electrical Specifications different from the designated Specifications can cause a fire and electric shock.
 - **Install and operate the product in places where appropriate lighting is available, allowing warning labels to be clearly read.**
To ensure safety for the customers, labels and printed instructions describing potentially hazardous situation are applied to places where accidents can be caused. Ensure that where the product is operated has sufficient lighting allowing the warnings to be read. If any label is peeled off, apply it again immediately. Please place an order with where the product was purchased from or the office herein stated.
 - **When handling the Monitor, be very careful. (Applies only to the product w/monitor.)**
Some of the monitor (TV) parts are subject to high tension voltage. Even after running off power, some portions are still subject to high tension voltage sometimes. Monitor repair and replacement should be performed only by those technical personnel who have knowledge of electricity and technical expertise.
 - **Be sure to adjust the monitor (projector) properly. (Applies only to the product w/monitor.)**
Do not operate the product leaving on-screen flickering or blurring as it is. Using the product with the monitor not properly adjusted may cause dizziness or a headache to an operator, a player, or the customers.
 - **When transporting or reselling this product, be sure to attach this manual to the product.**
In the case where commercially available monitors and printers are used in this product, only the contents relating to this product are explained herein. Some commercially available equipment has functions and reactions not stated in this manual. Read this manual together with the specific Instruction Manual of such equipment.
- Descriptions herein contained may be subject to improvement changes without notice.
 - The contents described herein are fully prepared with due care. However, should any question arise or errors be found, please contact SEGA.

INSPECTIONS IMMEDIATELY AFTER TRANSPORTING THE PRODUCT TO THE LOCATION.

Normally, at the time of shipment, SEGA products are in a status allowing for usage immediately after transporting to the location. Nevertheless, an irregular situation may occur during transportation. Before turning on power, check the following points to ensure that the product has been transported in a satisfactory status.

- Are there any dented portions or defects (cuts, etc.) on the external surfaces of the cabinet?
- Are Casters and Adjusters, damaged?
- Do the power supply voltage and frequency requirements meet with those of the location?
- Are all wiring connectors correctly and securely connected? Unless connected in the correct direction, connector connections can not be made accurately. Do not insert connectors forcibly.
- Do power cords have cuts and dents?
- Do the fuses used meet specified rating? Is the Circuit Protector in an energized status?
- Are all accessories available?
- Can all Doors and Lids be opened with the Accessory keys? Can Doors and Lids be firmly closed?

TABLE OF CONTENTS

BEFORE USING THE PRODUCT, BE SURE TO READ THE FOLLOWING:

TABLE OF CONTENTS

INTRODUCTION OF THE OWNER'S MANUAL

1. HANDLING PRECAUTIONS	1 - 2
2. PRECAUTIONS CONCERNING INSTALLATION LOCATION	3 - 4
3. OPERATION	5 - 8
4. ASSEMBLING AND INSTALLATION	9 - 17
5. PRECAUTIONS TO BE HEEDED WHEN MOVING THE MACHINE	18
6. GAME CONTENTS	19 - 23
7. EXPLANATION OF TEST AND DATA DISPLAY	24 - 54
7 - 1 SWITCH UNIT AND COIN METER	25
7 - 2 SYSTEM TEST MODE	26 - 41
7 - 3 GAME TEST MODE	42 - 54
8. CONTROL UNIT (SHOTGUN)	55 - 57
9. MONITOR	58 - 60
9 - 1 CLEANING THE SCREEN	58
9 - 2 PROJECTOR ADJUSTMENT	59 - 60
10. COIN SELECTOR	61 - 63
11. DESIGN RELATED PARTS	64
12. PARTS LIST	65 - 69
13. WIRE COLOR CODE TABLE	70
14. WIRING DIAGRAM	XXX

SPECIFICATIONS

Installation Space	: 60 inches width X 85 inches Deep
Height	: 84 inches
Width	: 34.5 inches
Depth	: 63 inches
Weight	: 400 lbs
Power, maximum current	: 420 W 3.5 A (AC 120V 60 Hz AREA)

MONITOR	: 29 inch supplied by Sanwa
	Monitor: 998-0162
	Chassis: 998-0161

INTRODUCTION OF THE OWNERS MANUAL

This Owner's Manual is intended to provide detailed descriptions together with all the necessary information covering the general operation of electronic assemblies, electromechanicals, servicing control, spare parts, etc. as regards the product,

THE HOUSE OF THE DEAD III UPRIGHT TYPE.

This manual is intended for the owners, personnel and managers in charge of operation of the product. Operate the product after carefully reading and sufficiently understanding the instructions. If the product fails to function satisfactorily, non-technical personnel should under no circumstances touch the internal system. Please contact where the product was purchased from.

Use of this product is unlikely to cause physical injuries or damages to property. However, where special attention is required this is indicated by a thick line, the word "IMPORTANT" and its sign in this manual.



Indicates that mishandling the product by disregarding this display can cause the product's intrinsic performance not to be obtained, resulting in malfunctioning.

IMPORTANT!

SEGA AMUSEMENTS USA, INC./CUSTOMER SERVICE
45133 Industrial Drive, Fremont, California 94538, U.S.A.
Phone : (415) 701-6580
Fax : (415) 701-6594

DEFINITION OF LOCATION MAINTENANCE MAN AND SERVICEMAN



Non-technical personnel who do not have technical knowledge and expertise should refrain from performing such work that this manual requires the location's maintenance man or a serviceman to carry out, or work which is not explained in this manual. Failing to comply with this instruction can cause a severe accident such as electric shock.

Ensure that parts replacement, servicing & inspections, and troubleshooting are performed by the location's maintenance man or the serviceman. It is instructed herein that particularly hazardous work should be performed by the serviceman who has technical expertise and knowledge.

The location's maintenance man and serviceman are herein defined as follows:

"Location's Maintenance Man" :

Those who have experience in the maintenance of amusement equipment and vending machines, etc., and also participate in the servicing and control of the equipment through such routine work as equipment assembly and installation, servicing and inspections, replacement of units and consumables, etc. within the Amusement Facilities and or locations under the management of the Owner and Owner's Operators of the product.

Activities of Location's Maintenance Man :

Assembly & installation, servicing & inspections, and replacement of units & consumables as regards amusement equipment, vending machines, etc.

Serviceman :

Those who participate in the designing, manufacturing, inspections and maintenance service of the equipment at an amusement equipment manufacturer.

Those who have technical expertise equivalent to that of technical high school graduates as regards electricity, electronics and or mechanical engineering, and daily take part in the servicing & control and repair of amusement equipment.

Serviceman's Activities :

Assembly & installation and repair & adjustments of electrical, electronic and mechanical parts of amusement equipment and vending machines.

LISTED



5K92

AMUSEMENT MACHINE

This page left Blank

1. HANDLING PRECAUTIONS

When installing or inspecting the machine, be very careful of the following points and pay attention to ensure that the player can enjoy the game safely.

Non-compliance with the following points or inappropriate handling running counter to the cautionary matters herein stated can cause personal injury or damage to the machine.



- Before performing work, be sure to turn power off. Performing the work without turning power off can cause an electric shock or short circuit. In the case work should be performed in the status of power on, this manual always states to that effect.
- To avoid electric shock or short circuit, do not plug in or unplug quickly.
- To avoid electric shock, do not plug in or unplug with a wet hand.
- Do not expose Power Cords and Earth Wires on the surface, (floor, passage, etc.). If exposed, the Power Cords and Earth Wires are susceptible to damage. Damaged cords and wires can cause electric shock or short circuit.
- To avoid causing a fire or electric shock, do not put things on or damage Power Cords.
- When or after installing the product, do not unnecessarily pull the power cord. If damaged, the power cord can cause a fire or electric shock.
- In case the power cord is damaged, ask for replacement through where the product was purchased from or the office herein stated. Using the cord as is damaged can cause fire, electric shock or leakage.
- Be sure to perform grounding appropriately. Inappropriate grounding can cause an electric shock.
- Be sure to use fuses meeting specified rating. Using fuses exceeding the specified rating can cause a fire or electric shock.
- Completely make connector connections for IC BD and others. Insufficient insertion can cause an electric shock.
- Specification changes, removal of equipment, conversion and/or addition, not designated by SEGA are not permitted.
 - Failure to observe this may cause a fire or an electric shock. Non-compliance with this instruction can have a bad influence upon physical conditions of the players or the lookers-on, or result in injury during play.
 - SEGA shall not be held responsible for damage, compensation for damage to a third party, caused by specification changes not designated by SEGA.
- Be sure to perform periodic maintenance inspections herein stated.



IMPORTANT!

- For the IC board circuit inspections, only the logic tester is allowed. The use of a multiple-purpose tester is not permitted, so be careful in this regard.
- Some parts are the ones designed and manufactured not specifically for this game machine. The manufacturers may discontinue, or change the specifications of, such general-purpose parts. If this is the case, Sega cannot repair or replace a failed game machine whether or not a warranty period has expired.

2. PRECAUTIONS CONCERNING INSTALLATION LOCATION



This product is an indoor game machine. Do not install it outside. Even indoors, avoid installing in places mentioned below so as not to cause a fire, electric shock, injury and or malfunctioning.

- Places subject to rain or water leakage, or places subject to high humidity in the proximity of an indoor swimming pool and or shower, etc.
- Places subject to direct sunlight, or places subject to high temperatures in the proximity of heating units, etc.
- Places filled with inflammable gas or vicinity of highly inflammable/volatile chemicals or hazardous matter.
- Dusty places.
- Sloped surfaces.
- Places subject to any type of violent impact.
- Vicinity of anti-disaster facilities such as fire exits and fire extinguishers.
- The operating (ambient) temperature range is from 5°C to 30°C.

LIMITATIONS OF USAGE REQUIREMENTS



- Be sure to check the Electrical Specifications.
Ensure that this product is compatible with the location's power supply, voltage and frequency requirements.
A plate describing Electrical Specifications is attached to the product.
Non-compliance with the Electrical Specifications can cause a fire and electric shock.
- This product requires the Breaker and Earth Mechanisms as part of the location facilities. Using them in a manner not independent can cause a fire and electric shock.
- Ensure that the indoor wiring for the power supply is rated at 3.5 A or higher (AC single phase 100~120 V area). Non-compliance with the Electrical Specifications can cause a fire and electric shock.
- Be sure to independently use the power supply equipped with the Earth Leakage Breaker. Using a power supply without the Earth Leakage Breaker can cause an outbreak of fire when earth leakage occurs.
- Putting many loads on one electrical outlet can cause generation of heat and a fire resulting from overload.
- When using an extension cord, ensure that the cord is rated at 3.5 A or higher (AC 100~120 V area). Using a cord rated lower than the specified rating can cause a fire and electric shock.

OPERATION AREA



- For the operation of this machine, secure a minimum area of 34.5 in. (W) × 78 in. (D). In order to prevent injury resulting from the falling down accident during game play, be sure to secure the minimum area for operation.
- Be sure to provide sufficient space so as to allow this product's ventilation fan to function efficiently. To avoid machine malfunctioning and a fire, do not place any obstacles near the ventilation opening.
- SEGA shall not be held responsible for damage, compensation for damage to a third party, resulting from the failure to observe this instruction.



For transporting the machine into the location's building, the minimum necessary dimensions of the opening (of doors, etc.) are 1 m (W) and 1.7 m (H).

Electric current consumption

MAX. 3.5 A (AC 120 V 60 Hz)

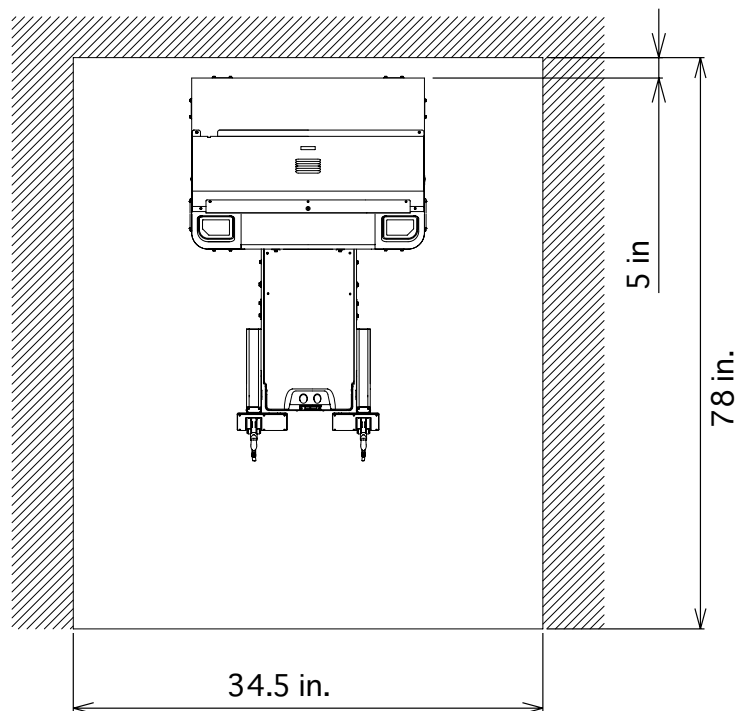

*NOTE: Picture may differ from actual unit.

FIG. 2

3. OPERATION

PRECAUTIONS TO BE HEEDED BEFORE STARTING THE OPERATION

To avoid injury and trouble, be sure to constantly give careful attention to the behavior and manner of the visitors and players.



In order to avoid accidents, check the following before starting the operation:

- To ensure maximum safety for the players and the customers, ensure that where the product is operated has sufficient lighting to allow any warnings to be read. Operation under insufficient lighting can cause bodily contact with each other, hitting accident, and or trouble between customers.
- Be sure to perform appropriate adjustment of the monitor (projector). For operation of this machine, do not leave monitor's flickering or deviation as is. Failure to observe this can have a bad influence upon the players' or the customers' physical conditions.
- It is suggested to ensure a space allowing the players who feel sick while playing the game to take a rest.
- Check if all of the adjusters are in contact with the surface. If they are not, the Cabinet can move and cause an accident.

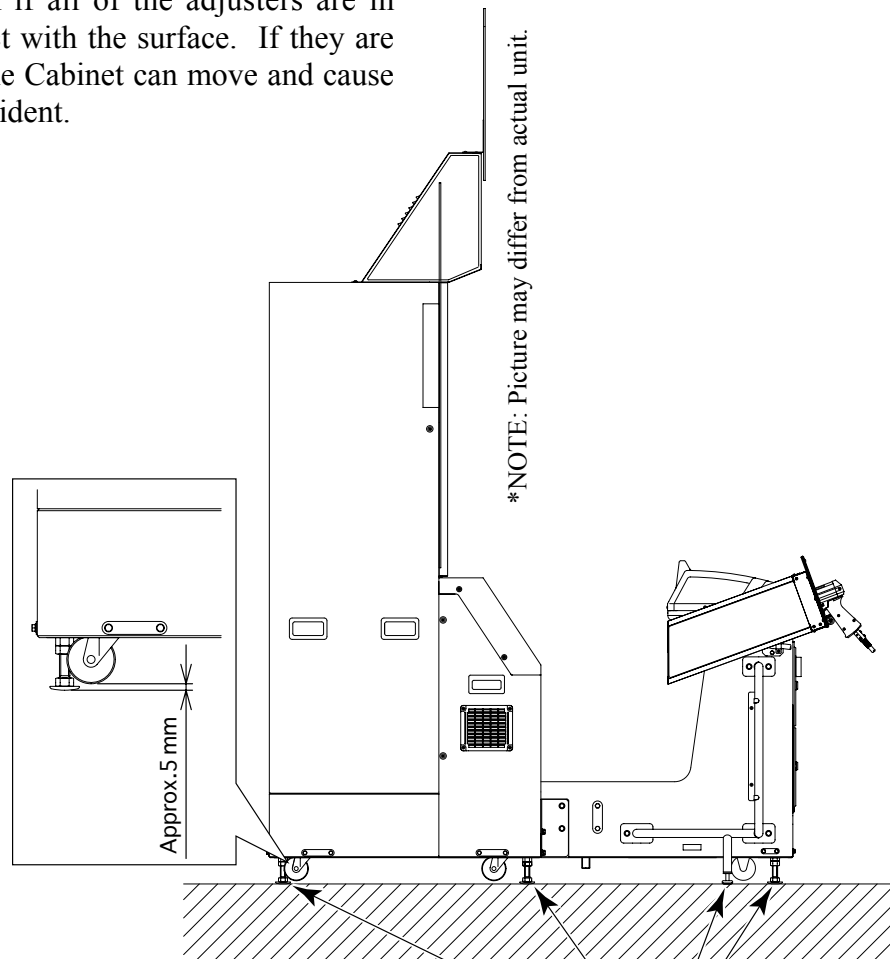

FIG. 3

Ensure that all of the Adjusters are in contact with the floor.



- Do not put any heavy item on this product. Placing any heavy item on the product can cause a falling down accident or parts damage.
- Do not climb on the product. Climbing on the product can cause falling down accidents. To check the top portion of the product, use a step.
- To avoid electric shock, check to see if door & cover parts are damaged or omitted.
- To avoid electric shock, short circuit and or parts damage, do not put the following items on or in the periphery of the product.
Flower vases, flowerpots, cups, water tanks, cosmetics, and receptacles/containers/vessels containing chemicals and water.



- To avoid injury, be sure to provide sufficient space by considering the potentially crowded situation at the installation location. Insufficient installation space can cause making bodily contact with each other, hitting accidents, and or trouble between customers.
- Every day when cleaning the Control Unit (Shotgun), inspect the Shotgun and make sure that there are no scratches or cracks in the surface, and that the fastening screws are not loose. If the game is played with scratches, cracks or loose screws it can cause injuries to the player or to people nearby.



Players with bare hands directly hold the controller. For operation, it is recommended that the wet towels (paper towels) be provided.



WARNING: HAZARD TO EPILEPTICS.

- A very small portion of the population has a condition which may cause them to experience epileptic seizures or have momentary loss of consciousness when viewing certain kinds of flashing lights or patterns that are present in our daily environment. These persons may experience seizures while watching some kinds of television pictures or playing certain video games. People who have not had any previous seizures may nonetheless have an undetected epileptic condition.
- If you or anyone in your family has experienced symptoms linked to an epileptic condition (e.g., seizures or loss of awareness), immediately consult your physician before using any video games.
- We recommend that parents observe their children while they play video games. If you or your child experience the following symptoms: dizziness, altered vision, eye or muscle twitching, involuntary movements, loss of awareness, disorientation, or convulsions, **DISCONTINUE USE IMMEDIATELY** and consult your physician.

PRECAUTIONS TO BE HEEDED DURING OPERATION(PAYING ATTENTION TO CUSTOMERS)

To avoid injury and trouble, be sure to constantly give careful attention to the behavior and manner of the visitors and players.



- To avoid injury and accidents, those who fall under the following categories are not allowed to play the game.
 - Those who need assistance such as the use of an apparatus when walking.
 - Those who have high blood pressure or a heart problem.
 - Those who have experienced muscle convulsion or loss of consciousness when playing video game, etc.
 - Those who have a trouble in the neck and or spinal cord.
 - Intoxicated persons.
 - Pregnant women or those who are in the likelihood of pregnancy.
 - Persons susceptible to motion sickness.
 - Persons whose act runs counter to the product's warning displays.
- A player who has never been adversely affected by light stimulus might experience dizziness or headache depending on his physical condition when playing the game. Especially, small children can be subject to those conditions. Caution guardians of small children to keep watch on their children during play.
- Instruct those who feel sick during play to have a medical examination.
- To avoid injury resulting from falling down and electric shock due to spilled drinks, instruct the player not to place heavy items or drinks on the product.
- To avoid electric shock and short circuit, do not allow customers to put hands and fingers or extraneous matter in the openings of the product or small openings in or around the doors.
- To avoid falling down and injury resulting from falling down, immediately stop the customer's leaning against or climbing on the product, etc.
- To avoid electric shock and short circuit, do not allow the customers to unplug the power plug without a justifiable reason.
- Be sure to instruct the adult responsible for children to watch them.
Children cannot sense danger. Approaching the player during play may result in accidental contact, collisions or falls.
If the Shotgun is pulled from the Gun Holder and dropped on the head it may cause injury.
- Caution the player not to wrap the Shotgun cord around his/her wrist or neck, as this can lead to serious injury.



- Immediately stop such violent acts as hitting and kicking the product. Such violent acts can cause parts damage or falling down, resulting in injury due to fragments and falling down.
- To avoid injury resulting from falling down, immediately stop the customer's leaning against or sitting down on the Gun Holder. Such acts can cause parts damage/deformation.
- Be sure to immediately stop any violent play, such as waving the Shotgun around or rapid back and forth pump action, as this may cause injury to the player or people nearby.
- If the player is too close to the Cabinet, the Shotgun can strike the Cabinet during play and cause accidents. Be sure to caution the player to maintain a safe distance from the Cabinet while playing.
- When 2 people are playing at the same time, be sure to caution them keep a safe distance from the other player. The Shotgun is long and can strike the other player if it is waved carelessly.
- Be sure to caution the player to grip the Shotgun firmly while playing. If the Shotgun is dropped, it can cause injury to the player.
- Large rings etc., can cause injury to the fingers during play. Be sure to caution the player to remove accessories that may cause accidents before commencing play.
- Be sure to caution players not to have 2 or more people holding 1 Shotgun, as this may result in accidental contact or collision.



The Shotguns for use on 1P side (left side) and 2P side (right side) are different. Ensure that players do not confuse the right and left side guns when starting play.

4. ASSEMBLING AND INSTALLATION



- Perform assembly work by following the procedure herein stated. Failing to comply with the instructions can cause electric shock hazard.
- Perform assembling as per this manual. Since this is a complex machine, erroneous assembling can cause an electric shock, machine damage and or not functioning as per specified performance.
- When assembling, be sure to use plural persons. Depending on the assembly work, there are some cases in which working by one person alone can cause personal injury or parts damage.
- Ensure that connectors are accurately connected. Incomplete connections can cause electric shock hazard.
- Be careful not to damage the wires. Damaged wires may cause electric shock or short circuit or present a fire risk.
- Do not carelessly push the PTV. Pushing the PTV carelessly can cause the PTV to fall down.
- This work should be performed by the Location's Maintenance Man or Serviceman. Performing work by non-technical personnel can cause a severe accident such as electric shock. Failing to comply with this instruction can cause a severe accident such as electric shock to the player during operation.
- Provide sufficient space so that assembling can be performed. Performing work in places with narrow space or low ceiling may cause an accident and assembly work to be difficult.
- To perform work safely and avoid serious accident such as the cabinet's falling down, do not perform work in places where step-like grade differences, a ditch, or slope exist.



- When handling plastic parts, use care. Do not give a shock or apply excessive load to the fluorescent lamps and plastic parts. Failure to observe this can cause parts damage, resulting in injury due to fragments, cracks and broken pieces.
- To perform work safely and securely, be sure to prepare a step which is in a secure and stable condition. Performing work without using the step can cause violent falling down accidents.
- Make sure that the GD cable connector is inserted parallel to the plug. Improper insertion may cause damage to the connector and present a fire risk.

When carrying out the assembling and installation, follow the following 8-item sequence.

- 1 INSTALLING THE GD-ROM DRIVE (SETTING GD-ROM DISC)
- 2 POWER SUPPLY, AND EARTH CONNECTION
- 3 TURNING POWER ON

The master key (accessories) in addition to the tools such as a Phillips type screwdriver, wrench, socket wrench and Ratchet Handle are required for the assembly work.

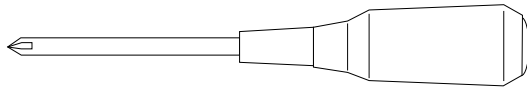

Phillips type screwdriver

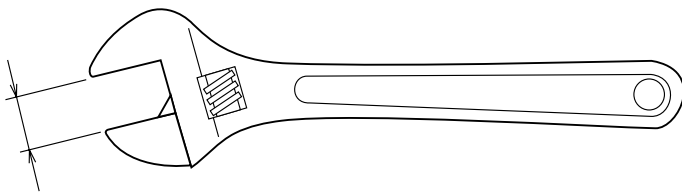

WRENCH (for hexagon bolt)

**TAMPERPROOF
WRENCH**

- T-40 Torx 5/16-18 (1)
- T-27 Torx 1/4-20 (1)
- T-15 Torx 8/32 (1)
- T-10 Torx (1)
- Tool (Included with Unit)

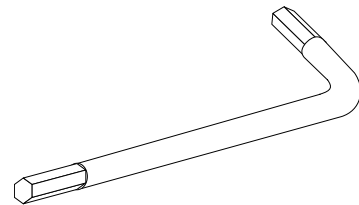

1 INSTALLING THE GD-ROM DRIVE (SETTING GD-ROM DISC)



- Carefully handle the GD-ROM drive so as not to contaminate the disc and the readout lens with stains and dust particles.
- Do not continue to use the scratched GD-ROM disc. The scratched GD-ROM disc may cause the system to malfunction.
- Set the GD-ROM disc onto the GD-ROM drive with its labeled side facing upward.
- The key chip is a precision device. Handle it carefully and avoid exposure to heat, shock and static electricity, as these may cause damage to the device.
- The key chip is contained in the GD-ROM disc case. Always use them as a set.

This section explains how to remove the ASSY MAIN BD from the PTV cabinet, set the GD-ROM disk onto the GD-ROM drive, and install the GD-ROM drive onto the ASSY MAIN BD.

- 1 Unpack the shipping crate, and take out the GD-ROM drive, GD-ROM drive bracket, and GD-ROM disc.



GD DRIVE BRACKET



GD-ROM DRIVE

PHOTO 6. 5 a

- 2 Use the 4 tapping screws to fix the GD-ROM drive bracket onto the GD-ROM drive. Be careful about a fixing direction.

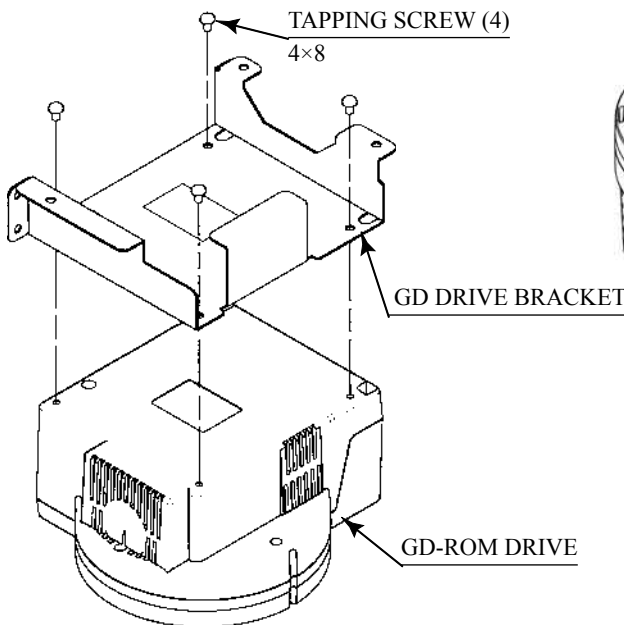
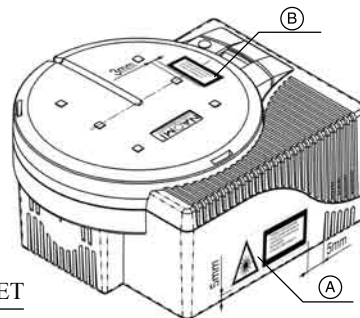

FIG. 6. 5 a



Please follow the drawing and place the sticker with the right language.

Application diagram

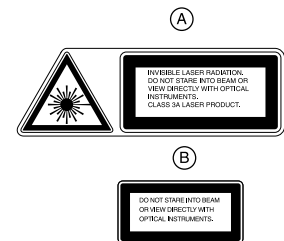
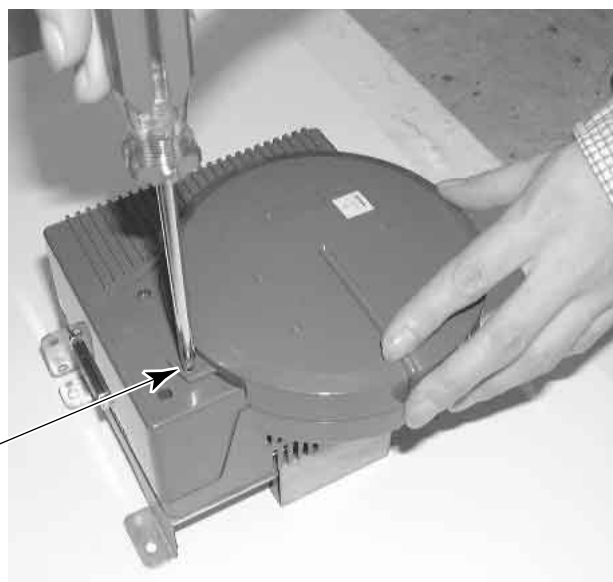

FIG. 6. 5 b

CAUTION for U. S. A., Europe, and Australia:
Attach the 2 caution stickers for a laser ray onto the GD-ROM drive.

- ③ Remove the 1 truss head screw that fixes the GD-ROM drive lid (DISC LID). And turn clockwise the lid to remove.



TRUSS SCREW (1)
M3x8

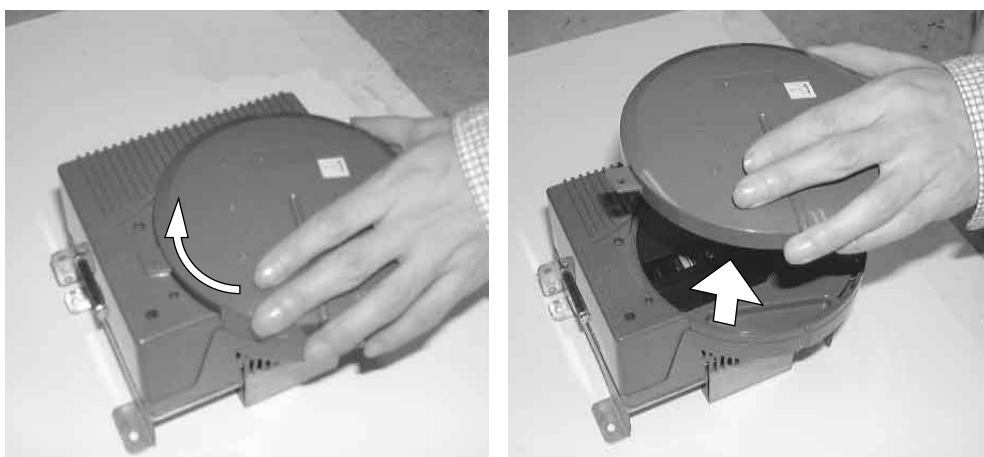

PHOTO 6. 5 b

- ④ Set the GD-ROM disc onto the GD-ROM drive with its labeled side facing upward.
- ⑤ Return the lid to its original place, and fix it with 1 truss head screw. Be careful not to fasten the screw too tightly.

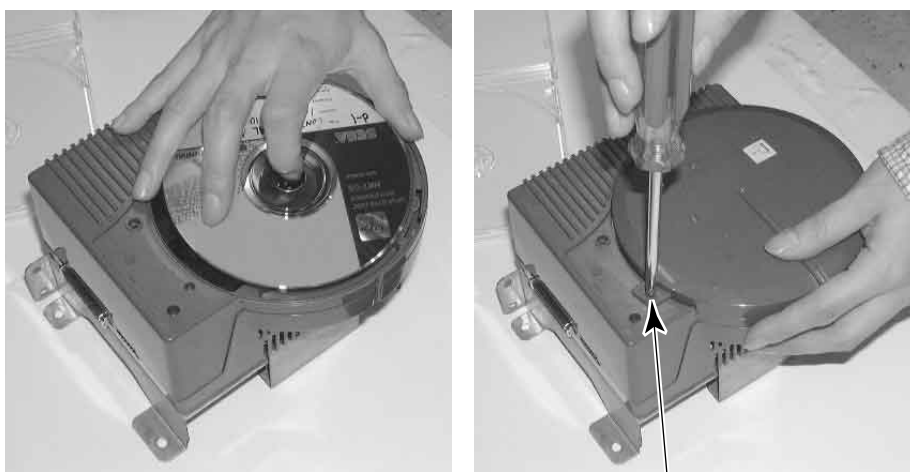

PHOTO 6. 5 c

TRUSS SCREW (1)
M3x8

- ⑥ Place the ASSY MAIN BD on a flat vertical surface.

Using the 4 screws, fix the GD-ROM drive onto the ASSY MAIN BD.

SCREW (4)
M4×16, w/flat & spring washers

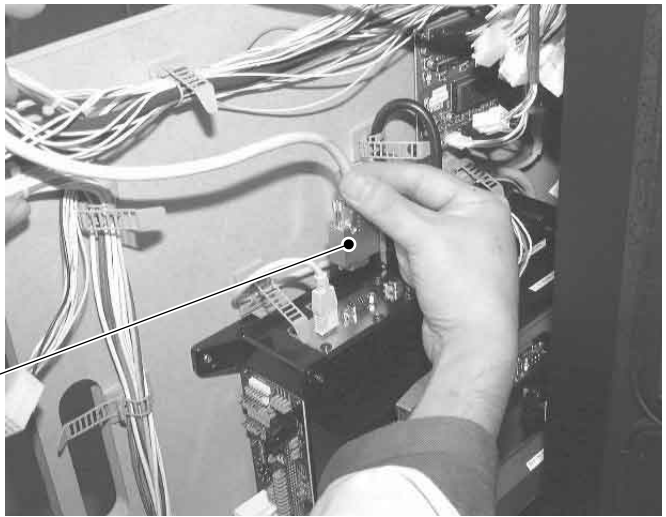

PHOTO 6. 5 h

- ⑦ Insert both the GD cable connector (for data communication) and the power cord connector (JST NH6P) into the GD-ROM drive. Be careful about an inserting direction in this instance. Make sure that the connectors are inserted firmly and completely.

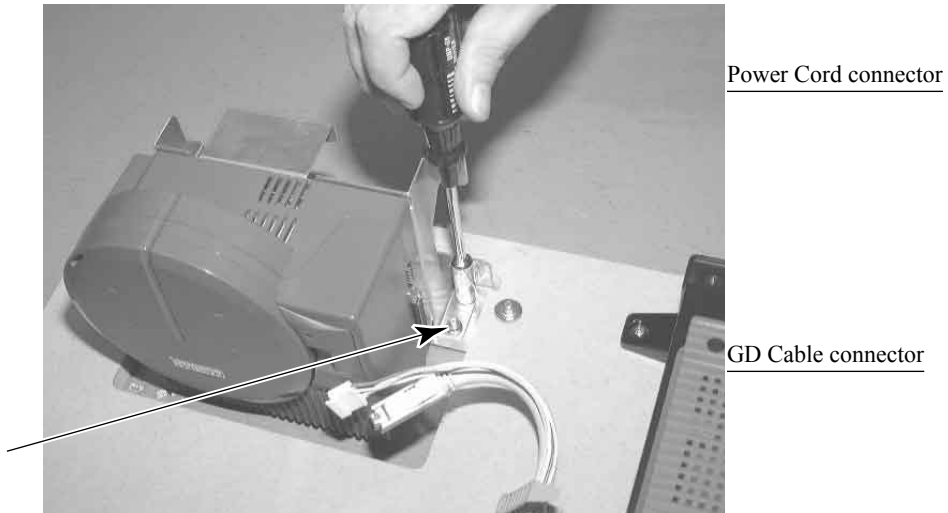

PHOTO 6. 5 i

*NOTE: Picture may differ from actual unit.

- ⑧ Insert the Key Chip straight into the hole in the top of the Media Board on the upper part of the Game Board. Carefully check the direction the Key Chip is facing, and push it in as far as it will go.

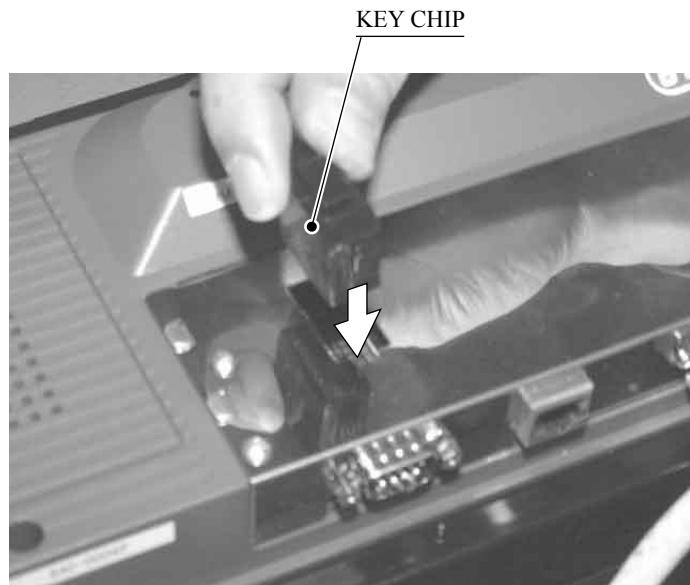

PHOTO 6.5 k

- ⑨ Attach the accessory stickers to both the Game Board and the Media Board.

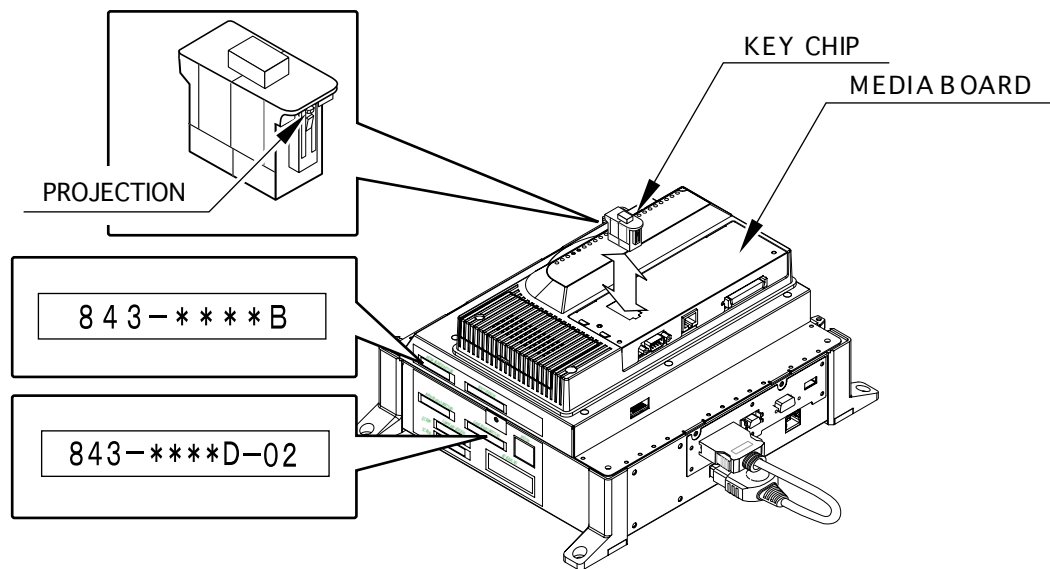

FIG. 6.5 c

2 POWER SUPPLY, AND EARTH CONNECTION



- Be sure to independently use the power supply socket outlet equipped with an Earth Leakage Breaker. Using a power supply without an Earth Leakage Breaker can cause a fire when electric leakage occurs.
- Ensure that the "accurately grounded indoor earth terminal" and the earth wire cable are available (except in the case where a power cord plug with earth is used). This product is equipped with the earth terminal. Connect the earth terminal and the indoor earth terminal with the prepared cable. If the grounding work is not performed appropriately, customers can be subjected to an electric shock, and the product's functioning may not be stable.
- Ensure that the power cord and earth wire are not exposed on the surface (passage, etc.). If exposed, they can be caught and are susceptible to damage. If damaged, the cord and wire can cause electric shock and short circuit accidents. Ensure that the wiring position is not in the customer's passage way or the wiring has protective covering.
- After wiring power cord on the floor, be sure to protect the power cord. Exposed power cord is susceptible to damage and causes an electric shoc accident.

The AC Unit is located on one side of Cabinet. The AC Unit has Main SW, Earth Terminal and the Inlet which connects the Power Cord.

- ① Ensure that the Main SW is OFF.

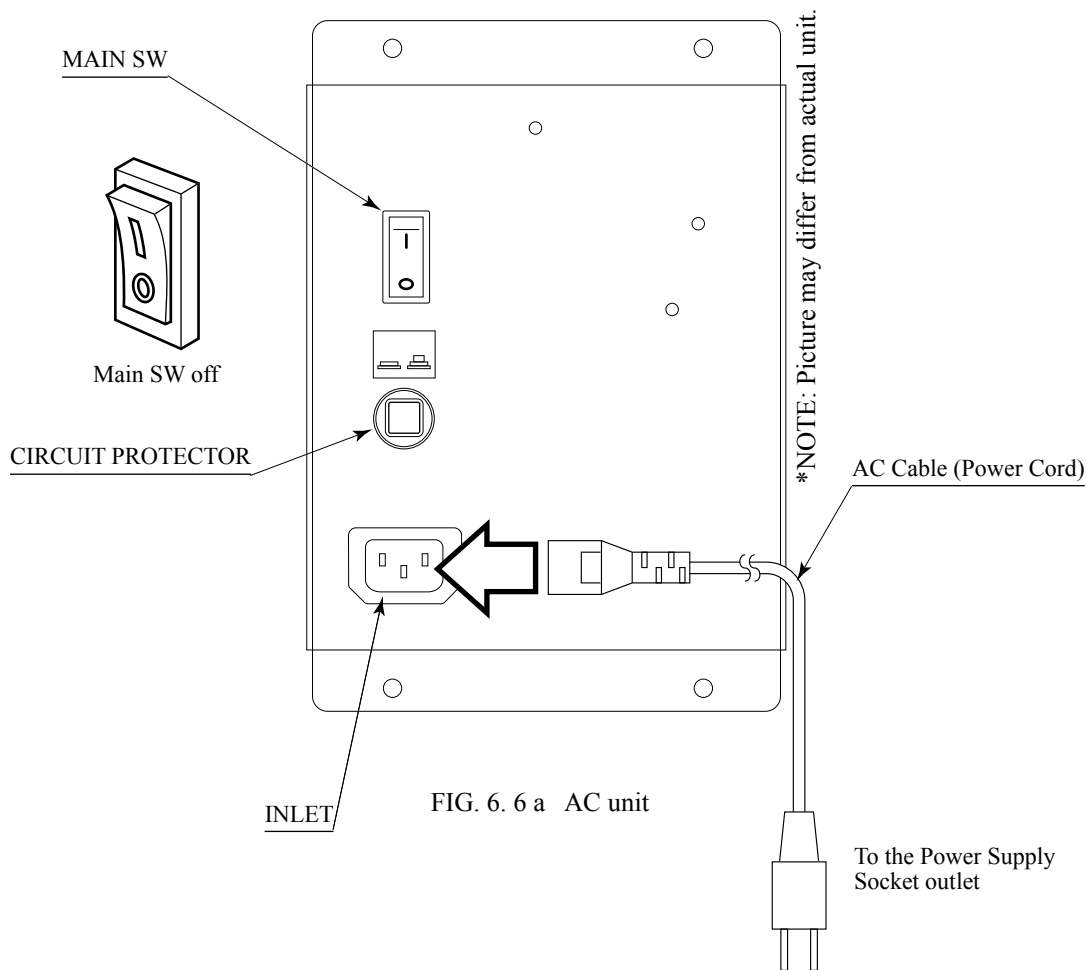

3

TURNING POWER ON

Turn on the AC unit's main switch to connect the power. When the power is connected, the fluorescent light in the billboard becomes on. A few seconds later a system startup screen appears and then an advertising screen (plying for a player screen) appears.

Time until displaying an advertising screen is not constant; it varies from some tens of second up to several minutes. This is due to the functional characteristics of the GD-ROM system's rechargeable battery and therefore normal.

When an advertising screen appears, sound is output from the speakers on the right and left of the PTV cabinet. Sound is not output if you have set the function to off.

After the power is disconnected, the system can maintain the data of credit number and ranking. The system cannot maintain, however, the fractional number of coins (not enough for one credit) and the bonus adder count data.

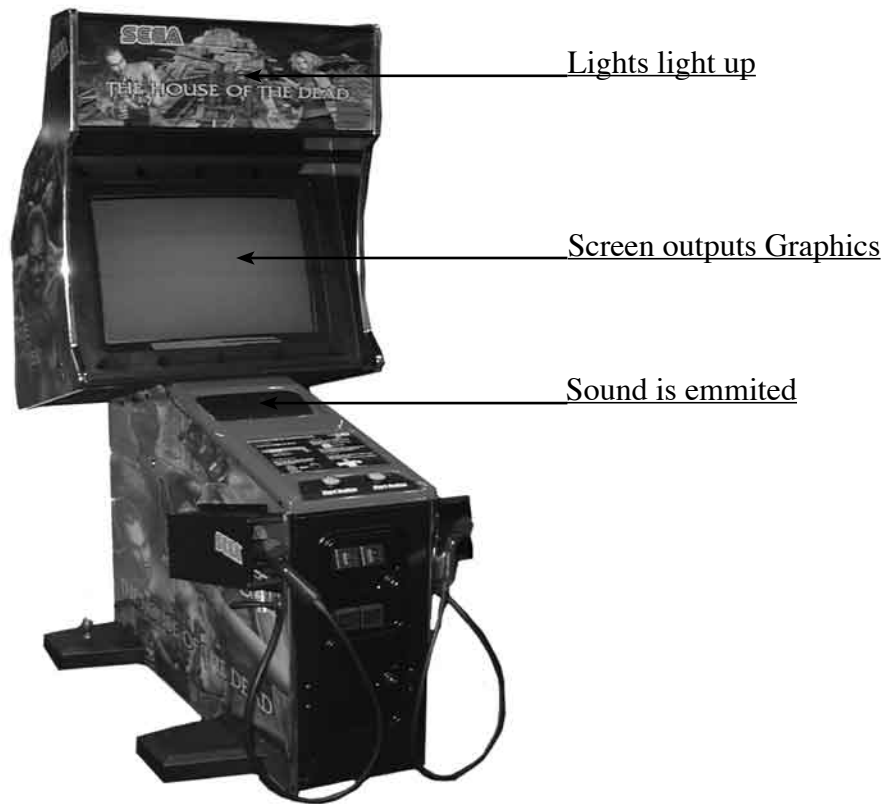

*NOTE: Picture may differ from actual unit.

FIG. 6. 7

THE INTERFERENCE PREVENTION WIRING



- In order to prevent electric shock and short circuit hazards, be sure to turn power off before performing work.
- Be careful not to damage the wires. Damaged wires may cause electric shock or short circuit or present a fire risk.
- Do not expose the IC BD, etc. without a good reason. Failure to observe this can cause electric shock hazard or malfunctioning.
- Work should be performed by the Location's Maintenance Man or technical personnel. Performing work by those who do not have technical knowledge and expertise can cause electric shock accident or malfunctioning.

When the game machines of a same or similar type are installed side by side, their sensors may interfere with each other. To reject the interference, follow the procedure below.

The following game machines employ a same or similar type of sensor. If interference happens to the sensors, operation of the games may be mutually disturbed.

- THE HOUSE OF THE DEAD 2, U/R type, DX type and Super DX type
- THE LOST WORLD, U/R type, DX type and Super DX type
- BRAVE FIRE FIGHTERS
- SAMBA DE AMIGO
- CONFIDENTIAL MISSION, U/R type and DX type
- SHAKATTO TAMBOURINE
- THE MAZE OF THE KINGS, U/R type and DX type

- ① Locate an interference rejection wire inside the cabinet.
If the game machines of a same or similar type are installed side by side, place them alternately (place the machine with an interference rejection wire next to the machine without).

INTERFERENCE PREVENTION WIRING SPY-60019



*NOTE: Picture may differ from actual unit.

PHOTO 6. 8

5. PRECAUTIONS TO BE HEEDED WHEN MOVING THE MACHINE



- When moving the machine, be sure to pull out the plug from the power supply. Moving the machine with the plug as is inserted can cause the power cord to be damaged and could result in a fire and or electric shock.
- When moving the machine on the floor, retract the Adjusters and ensure that Casters make contact with the floor. During transportation, pay careful attention so that Casters do not tread power cords and earth wires. Damaging the power cords can cause an electric shock and or short circuit.
- When lifting the cabinet, be sure to hold the catch portions or bottom part. Lifting the cabinet by holding other portions can damage parts and installation portions due to the empty weight of the cabinet, and cause personal injury.



- Do not move the product with a GD-ROM disk inside. Remove the GD-ROM disk before moving the product.
- Failure to observe this instruction may cause the GD-ROM disk and/or GD-ROM drive to be damaged.
- Do not hold or press the plastic parts. Failure to observe this instruction may break the parts, and eventually the broken pieces may cause a personal injury.



When moving the Cabinet, do not hold or push on the Gun Holder, as this may deform or damage the part.

6. GAME CONTENTS

The following explanations apply to the case the product is functioning satisfactorily. Should there be any moves different from the following contents, some sort of faults may have occurred. Immediately look into the cause of the fault and eliminate the cause thereof to ensure satisfactory operation.

While the power is connected, the fluorescent light in the billboard is on and demonstration images and ranking data are displayed. During this advertising period, sound is also output from the speakers in the center of the cabinet. Sound is not output if you have set the function to off. Each of the right and left start buttons is integrated with a light. The light flashes when coins are inserted sufficiently for a play. The light goes out when the start button is pressed to start the game.

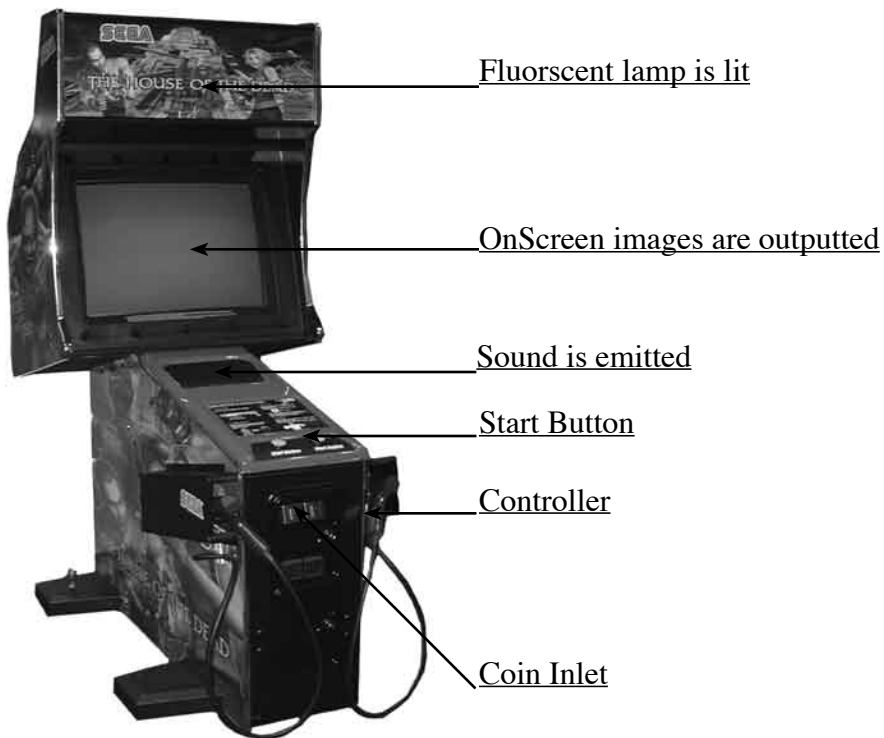

*NOTE: Picture may differ from actual unit.

FIG. 8

GAME OUTLINE

- Insert a coin and the credit indicator below the screen will count up. When enough coins have been entered for one play, the "INSERT COIN(S)" message below the screen will change to "PRESS START BUTTON", and both START buttons will flash.
- A player plays on the left or the right by pressing the start button on that side. Pressing the start button begins the game.
- When the game starts, the stage title is displayed and a demo plays before switching over to game play.
- Life and loaded bullets remaining are shown at the bottom left of the screen for the player on the left (Player 1). Life and loaded bullets remaining are shown at the bottom right of the screen for the player on the right (Player 2).

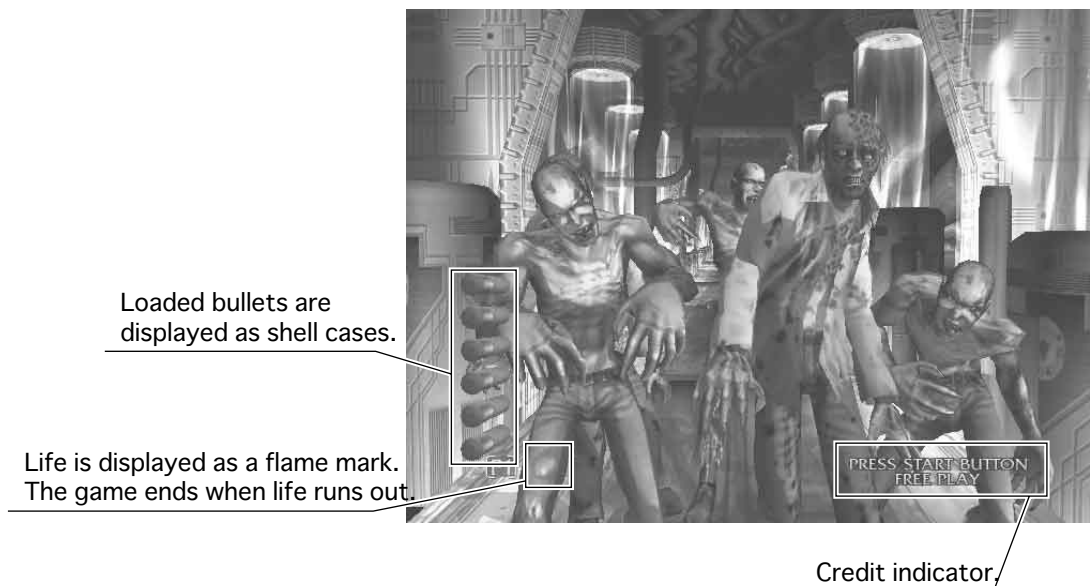

- Firing six rounds empties the weapon and displays the "RELOAD" instruction on the screen. Players load the shotgun clip by pump action. If some bullets remain, pumping the shotgun will fully reload the gun.

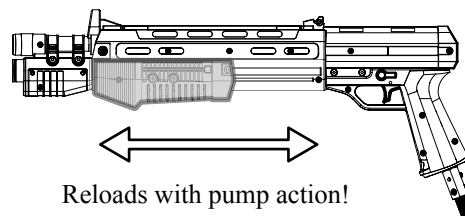

- Players can defend themselves against knives, oil drums and barrels thrown by enemies by shooting them.
- Shooting the background will sometimes cause items to appear. Players grab them by shooting them. Grabbing items will increase a player's score or restore life.
- When life reaches zero the game ends.
- A unique boss awaits the players at each stage. The bosses appear different on each stage. Players defeat a boss by reducing its Life Meter to zero. In addition, when a boss begins to attack the Cancel Meter appears. Players can stop the boss's attack by reducing this meter to zero.



This is the boss's life meter. You can defeat the boss by reducing it to zero.

This is the boss's cancel meter. You can stop the boss's attack by reducing it to zero.

Boss

- As players advance through the game, events will occur where enemies surround one player. The players' lives will increase if the other player succeeds in rescuing the surrounded player.



The players' lives will increase if they manage to drop the ene

Surrounded player

- A player can join a game in progress at any time by inserting coins and pressing the start button. In addition, the start button on the side where no one is playing will continue to flash if enough credits remain. A second player can join the game by pressing the flashing start button.
- "CONTINUE" is displayed when life drops to zero. A player may continue by inserting sufficient coins and pressing the start button. When there are enough credits for another game, a player can continue by pressing the start button.
- After completing the game, players can enter their names on the ranking display if their scores are among the top ten.

ITEMS



"Medical Kit"
Increases life by one.



"Mini magician"
Increases a player's score.



"Gold Coin"
Increases a player's score.



"Golden Frog"
Increases a player's score.



"Warped Coin"
Increases a player's score.



"MechaZombie"
Increases a player's score.



"Crystal Coin"
Continuously increases a player's score as it is shot.

PLAY HINTS

- Aim for the head!
On any stage, the weak point of enemy characters other than the boss is the head. Shooting the head will significantly decrease the enemy's life. The shotgun pellets spray out in a wide range, so players can cause more damage and drop an enemy more quickly by aiming at its head.
- Choose your favorite route!
The routes in stages (Stage 1, Stage 2, Stage 3, Stage 4) branch according to the players' choices. Players should find their own best routes as a way to improve their play.
- When life is low, restore it through life-increasing events!
A player's life decreases when attacked by an enemy, but numerous life-increasing events are provided throughout the stages. The life-increasing events happen at set locations within each stage. Repeated play will help players take advantage of these events.

7. EXPLANATION OF TEST AND DATA DISPLAY

By operating the switch unit, periodically perform the tests and data check. When installing the machine initially or collecting cash, or when the machine does not function correctly, perform checking in accordance with the explanations given in this section.

The following shows tests and modes that should be utilized as applicable.

This product's basic system consists of the Chihiro game board and the GD-ROM drive. The system enables you to play several games one after the other just by changing a GD-ROM disc that is to be set on the GD-ROM drive.

The product supports, therefore, the following 2 test modes:

- (1) System test mode for an automatic self-diagnostic test (generally used by every product that contains the basic system) and a coin assignment (specifically used by this product) and
- (2) Game test mode for testing the input/output control devices and setting the difficulty level (specifically used by this product).

TABLE 9 EXPLANATION OF TEST MODE

ITEMS	DESCRIPTION
INSTALLATION OF MACHINE	When the machine is installed, perform the following: 1. Check to ensure each is the standard setting at shipment. 2. Check each Input equipment in the INPUT TEST mode. 3. Check each Output equipment in the OUTPUT TEST mode. 4. Test on-IC-Board IC's in the self-test mode.
MEMORY TEST	This test is automatically executed by selecting RAM TEST, or ROM BOARD TEST in the Menu mode.
PERIODIC SERVICING	Periodically perform the following: 1. MEMORY TEST 2. Ascertain each setting. 3. To test each Input equipment in the INPUT TEST mode. 4. To test each Output equipment in the OUTPUT TEST mode.
CONTROL SYSTEM	1. To check each Input equipment in the INPUT TEST mode. 2. Adjust or replace each Input equipment. 3. If the problem still remains unsolved, check each equipment's mechanism movements.
MONITOR	In the Monitor Adjustment mode, check to see if Monitor (Projector) adjustments are appropriate.
IC BOARD	1. MEMORY TEST 2. In the SOUND TEST mode, check the sound related ROMs.
DATA CHECK	Check such data as game play time and histogram to adjust the difficulty level, etc.

7-1 SWITCH UNIT AND COIN METER



WARNING

Never touch places other than those specified. Touching places not specified can cause electric shock and short circuit accidents.



IMPORTANT

- Adjust the sound to the optimum volume, taking into consideration the environmental requirements of the installation location.
- Removing the Coin Meter circuitry renders the game inoperable.

SWITCH UNIT

Open the coin chute door, and the switch unit shown will appear.

The functioning of each SW is as follows:

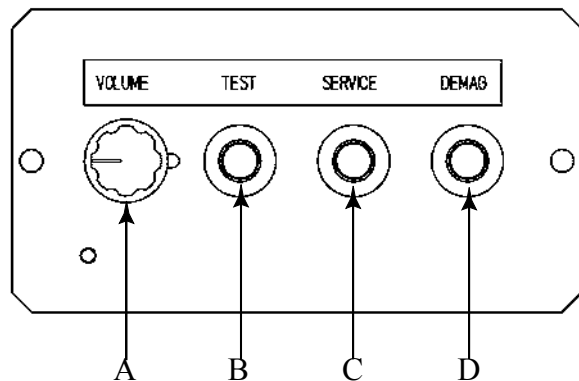

FIG. 9. 1 a SWITCH UNIT

- A **SPEAKER VOLUME SWITCH:** Adjusts sound volume for all of the machines' Speakers.
(VOLUME)
- B **TEST BUTTON:** For the handling of the test button, refer to the following pages.
(TEST)
- C **SERVICE BUTTON:** Gives credits without registering on the coin meter.
(SERVICE)
- D **DEMAGNETIZER BUTTON:** Eliminates the on-screen color unevenness due to magnetization of CRT.
(DEMAG) First use this SW before performing the monitor's color adjustment.

COIN METER

Open the Cashbox Door by using the key to have the Coin Meter appear underneath the Cashbox.

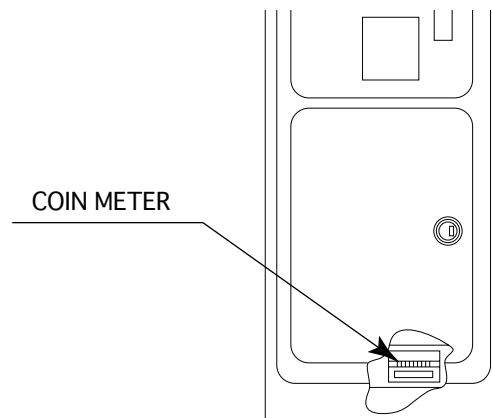

FIG. 9. 1 b



- Any settings that are changed by users during TEST MODE are saved upon exiting TEST MODE with the EXIT command in the SYSTEM MENU. If the unit is powered off prior to exiting, changes to settings will not take effect.
- You may not enter GAME TEST MODE while the unit is reading from or checking the GD-ROM. If error messages are displayed when exiting TEST MODE, you should power the unit off and on again.
- In the manual for this product, "Media Board" and "DIMM" are one and the same.
- Use with the specified settings. If settings other than those specified are used, inappropriate operations or malfunction may occur.

A. SYSTEM TEST MENU MODE

System Test Mode can be used to check that the main circuit operations are correct, adjust Monitor color, and perform coin/credit settings.

However, this product can only be used with the settings shown below.

- SOUND TEST
 - OUTPUT TYPE: STEREO
- COIN ASSIGNMENTS
 - COIN CHUTE TYPE: COMMON
 - SERVICE TYPE: COMMON
- NETWORK SETTING (MEDIA)
 - NETWORK TYPE: NONE
- Press the TEST Button after powering on the unit to display the following SYSTEM MENU.

```

SYSTEM MENU

MEDIA BOARD TEST
SYSTEM INFORMATION
JVS TEST
SOUND TEST
C.R.T. TEST
COIN ASSIGNMENTS
CLOCK SETTING
NETWORK SETTING(CORE)
NETWORK SETTING(MEDIA)
ENTER GAME TEST
[*****]
EXIT

SELECT WITH SERVICE BUTTON
AND PRESS TEST BUTTON

```

- Press the SERVICE Button to move the cursor to the desired test item.
- Move the cursor to the desired item and press the TEST Button to display each test screen.
- Move the cursor to ENTER GAME TEST and press the TEST Button to enter the individual test menus for each game. Refer to "9-3 GAME TEST MODE".
- When testing is complete, move the cursor to EXIT and press the TEST Button. The game advertisement screen should be displayed.

B. MEDIA BOARD TEST



Powering off the system during the MEDIA BOARD TEST with a DIMM BOARD will erase the game programme data. It may be necessary to reload the data.
Always wait for the test to complete before attempting to exit.

MEDIA BOARD TEST is used to check the memory and IC on the MEDIA BOARD connected to the Chihiro. Test screens and test times may differ depending on the type of MEDIA BOARD connected to the unit.

- The following is the MEDIA BOARD TEST screen for a unit with a DIMM BOARD.

```
MEDIA BOARD TEST

VERSION ****
STATUS GOOD
CHECKING 100%

SYSTEM TEST
DIMM0 - GOOD
DIMM1 - GOOD
IC34,35S - GOOD
IC10,11S - GOOD
GD DRIVE - GOOD
-- COMPLETED --

PRESS TEST BUTTON TO EXIT
```

- MEDIA BOARD TEST begins immediately upon entering this test mode.
- If "GOOD" is displayed to the right of each item, the MEDIA BOARD components are functioning properly.
- After the test is complete, move the cursor to EXIT and press the TEST Button to return to the SYSTEM MENU screen.

C. SYSTEM INFORMATION

Use SYSTEM INFORMATION to check version and other information for system programmes. Screens may differ depending on the type of MEDIA BOARD connected to the unit.

- The following is the SYSTEM INFORMATION screen for a unit with a DIMM BOARD.

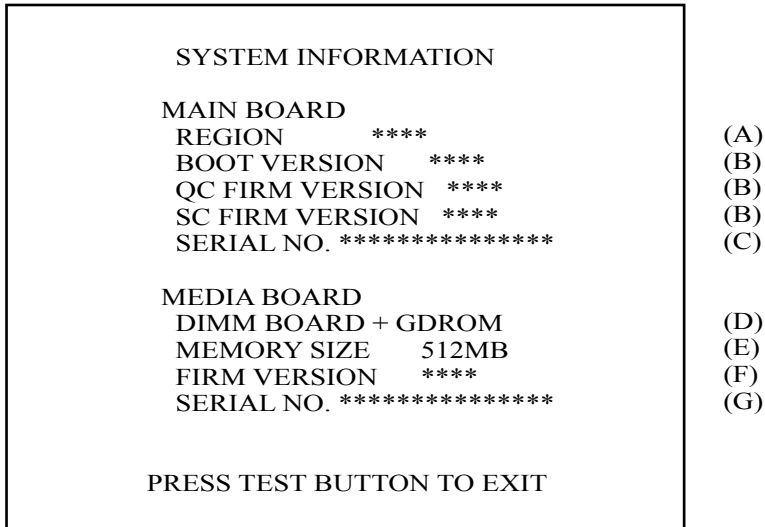

Press the TEST Button to return to the SYSTEM MENU screen.

- (A) REGION
The COUNTRY CODE of the MAIN BOARD.
- (B) BOOT VERSION, QC FIRM VERSION, SC FIRM VERSION
Version information for the MAIN BOARD system programmes.
- (C) SERIAL NO.
Serial number of the MAIN BOARD.
- (D) DIMM BOARD + GDROM
Type of MEDIA BOARD. This example shows a DIMM BOARD with a GD-ROM DRIVE connected.
- (E) MEMORY SIZE
Capacity of DIMM memory installed on the DIMM BOARD.
- (F) FIRM VERSION
Version information for the DIMM BOARD system programme.
- (G) SERIAL NO.
Serial number of the DIMM BOARD.

D. JVS TEST

JVS TEST is used to verify the specs of the I/O BOARD connected to the Chihiro and to run input tests.

I/O BOARD specs are displayed initially.

Screens may differ depending on the type of I/O BOARD connected to the unit.

```
JVS TEST
INPUT TEST
NEXT NODE
EXIT
NODE      ****
NAME      ****
          I/O BD JVS
          Ver****
          ****
CMD VER   1.1
JVS VER   2.0
COM VER   1.0
SWITCH    2 PLAYER(S) 13 BITS
COIN      2 SLOT
ANALOG    8 CH
ROTARY    0 CH
KEYCODE   0
SCREEN    X:0 Y:0 CH:0
CARD      0 SLOT
HOPPER OUT 0 CH
DRIVER OUT 6 CH
ANALOG OUT 0 CH
CHARACTER CHARA:0 LINE:0
BACKUP    0
          SELECT WITH SERVICE BUTTON
          AND PRESS TEST BUTTON
```

- Use the SERVICE Button to move the cursor to the desired test item.
- Move the cursor to INPUT TEST and press the TEST Button to enter the INPUT TEST screen for the I/O BOARD currently displayed.
- When 2 or more I/O BOARDS are connected, move the cursor to NEXT NODE and press the TEST Button to enter the test screen for the next I/O BOARD. The lower the NODE number, the further away the node is from the Chihiro.
- Move the cursor to EXIT and press the TEST Button to return to the SYSTEM MENU screen.

INPUT TEST Screen

JVS TEST		
INPUT TEST		
NODE	1/1	
SYSTEM	00	(A)
PLAYER 1	0000	(A)
PLAYER 2	0000	(A)
COIN 1	0000	(B)
COIN 2	0000	(B)
ANALOG 1	0000	(C)
ANALOG 2	0000	(C)
ANALOG 3	0000	(C)
ANALOG 4	0000	(C)
ANALOG 5	0000	(C)
ANALOG 6	0000	(C)
ANALOG 7	0000	(C)
ANALOG 8	0000	(C)

PRESS TEST AND SERVICE BUTTON TO EXIT

- On-screen values change according to the input from switches and the volume.
 - (A) SYSTEM, PLAYER
Values change with input from control panel/other switches.
 - (B) COIN
Increases with input from the COIN SWITCH. The count is cleared when exiting TEST MODE.
 - (C) ANALOG
Displays analog values from "0000" to "FFFF".
- Press the SERVICE and TEST Buttons simultaneously to return to the JVS TEST main screen.

E. SOUND TEST

Use SOUND TEST to test sound output and to select the stereo/mono/surround setting.

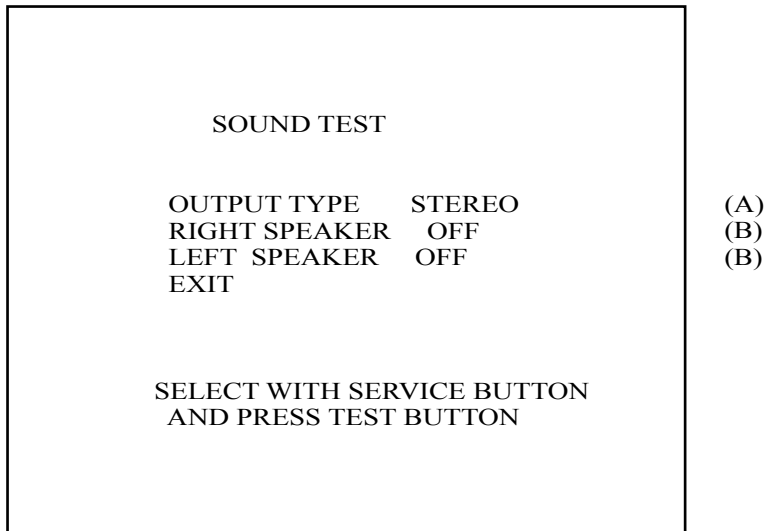

- Use the SERVICE Button to move the cursor to the desired test item.
- Press the TEST Button to enter the selected item.
 - (A) OUTPUT TYPE(STEREO, MONO, SURROUND)
Select the sound output from the I/O PANEL audio output interface setting among STEREO, MONO and SURROUND.
 - (B) RIGHT/LEFT SPEAKER(ON, OFF)
When set to "ON", the test sends a beep to each audio output interface. Only the word "SPEAKER" is displayed when the OUTPUT TYPE is set to "MONO", and when set to "ON", the test sends the same beep to both the left/right audio output interfaces.
To test surround output, it is necessary to use a separate Audio Amp, and receive signal from a terminal not in use at the time of shipping.
Note: Not available with this product.
- Move the cursor to EXIT and press the TEST Button to return to the SYSTEM MENU screen.

F. C.R.T. TEST

Use the C.R.T. TEST to adjust monitor colours and verify screen size.

COLOUR CHECK Screen

- Monitor COLOUR CHECK screen is displayed initially.
Each of the colours (red, green and blue) is darkest at the far left and gets progressively lighter (32 steps) towards the right.
Monitor brightness is set correctly if the white colour bar is black at the left edge and white at the right edge.

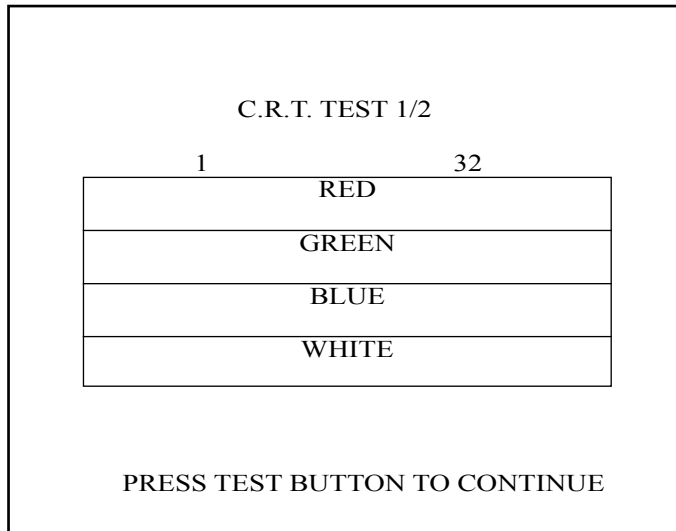

- Press the TEST Button to proceed to the next page.

SIZE CHECK Screen

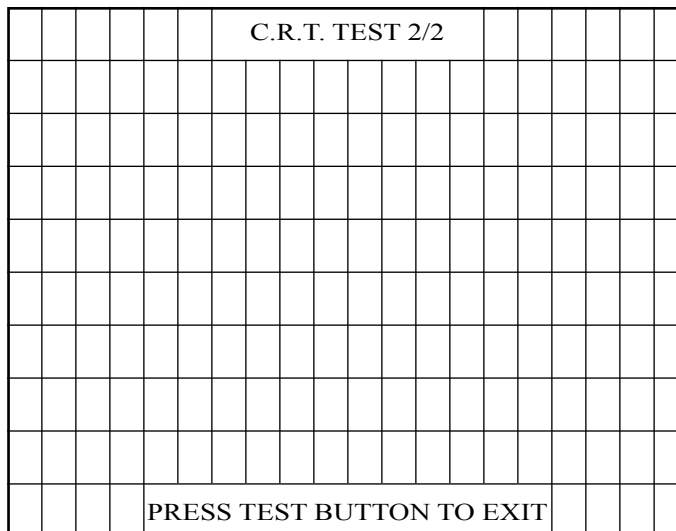

- Adjust the CHECK GRID so that the entire GRID is displayed on the screen.
- Press the TEST Button to return to the SYSTEM MENU screen.

G. COIN ASSIGNMENTS

Use COIN ASSIGNMENTS to set the credit rate for each coin inserted.

- Use the SERVICE Button to move the cursor to the desired test item.
- Press the TEST Button to change the setting or to open the detailed settings.
- Move the cursor to EXIT and press the TEST Button to return to the SYSTEM MENU screen.

COIN ASSIGNMENTS	
COIN CHUTE TYPE	COMMON
SERVICE TYPE	COMMON
COIN CHUTE #1 COIN TO CREDIT RATE	
1 COIN(S) COUNT AS 1 CREDIT(S)	
COIN CHUTE #2 COIN TO CREDIT RATE	
1 COIN(S) COUNT AS 1 CREDIT(S)	
DETAIL SETTING	
GAME COST SETTING	
→EXIT	
SELECT WITH SERVICE BUTTON AND PRESS TEST BUTTON	

COIN CHUTE TYPE...COMMON

COIN ASSIGNMENTS	
COIN CHUTE TYPE	INDIVIDUAL
SERVICE TYPE	INDIVIDUAL
COIN CHUTE #1 COIN TO CREDIT RATE	
1 COIN(S) COUNT AS 1 CREDIT(S)	
DETAIL SETTING	
GAME COST SETTING	
→EXIT	
SELECT WITH SERVICE BUTTON AND PRESS TEST BUTTON	

COIN CHUTE TYPE...INDIVIDUAL

(A) COIN CHUTE TYPE(COMMON, INDIVIDUAL)

Adjust settings according to the specs of the cabinet COIN CHUTE.

COMMON

This is for cabinets where a single COIN CHUTE is used by multiple players.

Coins inserted by each player are treated as common credits.

Up to 2 COIN CHUTES (#1 and #2) may be used. The (C) COIN TO CREDIT RATE setting for COIN CHUTE #1 and #2 may be set differently.

INDIVIDUAL

This is for cabinets with individual COIN CHUTES for each player.

Coins inserted by each player are treated as individual player credits.

The (C) COIN TO CREDIT RATE setting is used by all COIN CHUTES.

(B) SERVICE TYPE(COMMON, INDIVIDUAL)

Use this to set the function of each SERVICE Button when there is more than one SERVICE Button.

COMMON

Pressing any SERVICE Button enters service credits for all players.

INDIVIDUAL

Pressing the SERVICE Button enters service credits only for the corresponding player.

- (C) COIN TO CREDIT RATE
 Set the CREDIT RATE for each coin inserted.
 The " x COIN(S) COUNT AS x CREDIT(S)" setting indicates that "Inserting x coins equals x credits".
 Set this to "FREE PLAY" to allow game play without credits.
 When (A) COIN CHUTE TYPE is set to "COMMON", COIN CHUTE #2 settings are restricted to some extent by the settings for COIN CHUTE #1.
- (D) DETAIL SETTING
 This mode allows for more detailed credit rate settings than the (C) COIN TO CREDIT RATE setting.
 Changes made in DETAIL SETTING override any (C) COIN TO CREDIT RATE settings.

DETAIL SETTING Screen

<p style="text-align: center;">COIN ASSIGNMENTS DETAIL SETTING</p> <p>COIN CHUTE #1 MULTIPLIER 1 COIN COUNT AS 1 COIN(S)</p> <p>COIN CHUTE #2 MULTIPLIER 1 COIN COUNT AS 1 COIN(S)</p> <p>BONUS ADDER NO BONUS ADDER</p> <p>COIN TO CREDIT 1 COIN(S) 1 CREDIT</p> <p>→EXIT</p> <p>COIN CHUTE #1 OPERATION COIN 1 2 3 4 5 6 7 8 9 CREDIT 1 2 3 4 5 6 7 8 9</p> <p>COIN CHUTE #2 OPERATION COIN 1 2 3 4 5 6 7 8 9 CREDIT 1 2 3 4 5 6 7 8 9</p> <p style="text-align: center;">SELECT WITH SERVICE BUTTON AND PRESS TEST BUTTON</p>	<p>(E)</p> <p>(E)</p> <p>(F)</p> <p>(G)</p>	<p style="text-align: center;">COIN ASSIGNMENTS DETAIL SETTING</p> <p>COIN CHUTE #1 MULTIPLIER 1 COIN COUNT AS 1 COIN(S)</p> <p>BONUS ADDER NO BONUS ADDER</p> <p>COIN TO CREDIT 1 COIN(S) 1 CREDIT</p> <p>→EXIT</p> <p>COIN CHUTE #1 OPERATION COIN 1 2 3 4 5 6 7 8 9 CREDIT 1 2 3 4 5 6 7 8 9</p> <p style="text-align: center;">SELECT WITH SERVICE BUTTON AND PRESS TEST BUTTON</p>
COIN CHUTE TYPE...COMMON		COIN CHUTE TYPE...INDIVIDUAL

- (E) COIN CHUTE MULTIPLIER
 Use this to set how many coins will be counted for each coin inserted.
 The " 1 COIN COUNT AS x COIN(S)" setting indicates that "Each coin will be counted as x coins".
 When the (A) COIN CHUTE TYPE is set to "COMMON", the setting may be set individually for COIN CHUTE #1 and #2.
- (F) BONUS ADDER
 Use this to set the number of coins calculated with the (E) COIN CHUTE MULTIPLIER setting that need to be inserted to get 1 bonus coin. When the (A) COIN CHUTE TYPE is set to "COMMON", the sum of the coins for COIN CHUTE #1 and #2 is used for the calculation.
 The " x COINS GIVE 1 EXTRA COIN" setting indicates that "For every x coins, 1 bonus coin is given".
 Set this to "NO BONUS ADDER" to disable bonus coins entirely.
- (G) COIN TO CREDIT
 Use this to set how many coins calculated with the (F) BONUS ADDER setting count as 1 credit.
 The " x COIN(S) 1 CREDIT" setting indicates that "Every x coins equals 1 credit."

(H) GAME COST SETTING

Use this mode to set the number of credits required to start a game.
Screens may differ depending on the game.

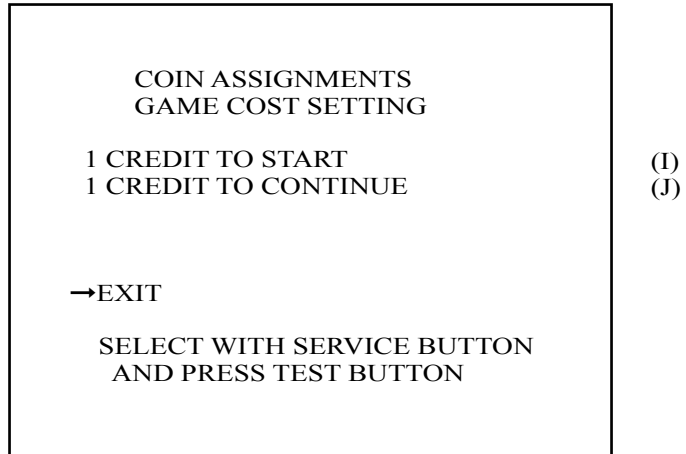

(I) Set the number of credits required to start a game.

(J) Set the number of credits required to continue a game.

H. CLOCK SETTING

Use CLOCK SETTING to set the Chihiro internal clock.

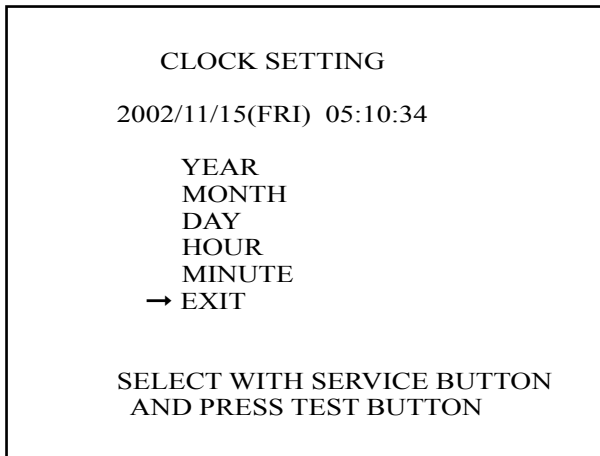

- Use the SERVICE Button to move the cursor to the item to be set.
- Move the cursor to the desired item and press the TEST Button to increase values. The max value for YEAR is "2099"; further increases return the value to "2000".
- Move the cursor to EXIT and press the TEST Button to return to the SYSTEM MENU screen.

I. NETWORK SETTING (CORE)

Use the LAN PORT attached to the Main Board, and carry out the settings necessary for network communication.

Note: This function is not available with this product.

NETWORK SETTING (CORE)	
->REMOTE(C) ENABLE	(A)
IP ADDRESS(C)	(B)

SUBNET MASK(C)	(C)

GATE WAY(C)	(D)

PRIMARY DNS(C)	(E)

EXIT	
CURRENT *****	(F)
*** ** *	
SELECT WITH SERVICE BUTTON AND PRESS TEST BUTTON	

- Use the SERVICE Button to move the cursor to the desired test item.
(When setting IP ADDRESS, SUBNET MASK, GAME WAY or PRIMARY DNS, use the underline as a guide.)
- Press the TEST Button to change the setting.
- Move the cursor to EXIT and press the TEST Button to return to the SYSTEM MENU screen.

- (A) REMOTE (C)
This sets up whether a communication setting is automatic or manual.
ENABLE: Sets the communication setting automatically.
DISABLE: Sets the communication setting manually.
- (B) IP ADDRESS (C)
This is one of the settings required for communication network. After setting the number, press TEST Button on SET position to memorize the setting. If you set the REMOTE setting to ENABLE, you cannot select this.
- (C) SUBNET MASK (C)
This is one of the settings required for communication network. After setting the number, press TEST Button on SET position to memorize the setting. If you set the REMOTE setting to ENABLE, you cannot select this.
- (D) GATE WAY (C)
This is one of the settings required for communication network. After setting the number, press TEST Button on SET position to memorize the setting. If you set the REMOTE setting to ENABLE, you cannot select this.
- (E) PRIMARY DNS (C)
This is one of the settings required for communication network. After setting the number, press TEST Button on SET position to memorize the setting. If you set the REMOTE setting to ENABLE, you cannot select this.
- (F) CURRENT
This displays the present setting value during a setup of each item [(B), (C), (D), (E)]. Pressing TEST Button on SET position, the settings are memorized and the screen is changed.

J. NETWORK SETTING (MEDIA)

Use NETWORK SETTING to establish and test network connections.

This is only displayed when a network enabled MEDIA BOARD is connected to the Chihiro.

- This game does not support network communication connections.
Set (A) NETWORK TYPE to "NONE".

- Use the SERVICE Button to move the cursor to the desired test item.
- Press the TEST Button to change the setting or to open the detailed settings.
- Move the cursor to EXIT and press the TEST Button to return to the SYSTEM MENU screen.

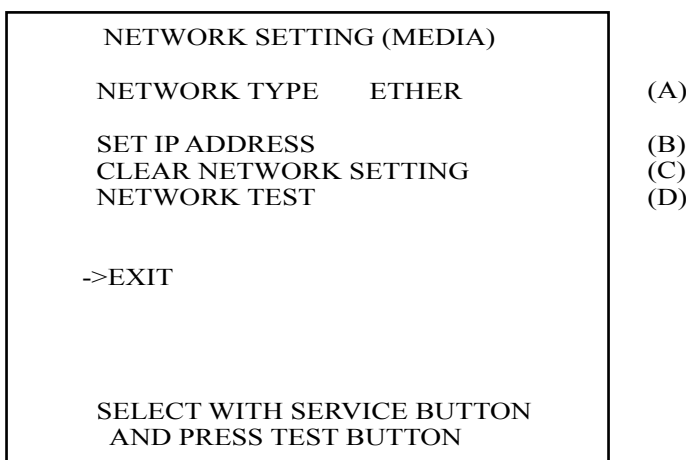

(A) NETWORK TYPE

Choose a type of the communication network.

NONE: Sets that the communication system does not perform. Sets to NONE when you don't set the network system.

ETHER: Sets ETHER for the communication network.

MOBILE: Sets a mobile communication terminal for the communication network.

ETHER+MOBILE

DEFAULT ETHER: Set ETHER or MOBILE automatically for the communication network. Priority is given to ETHER.

ETHER+MOBILE

DEFAULT MOBILE: Set ETHER or MOBILE automatically for the communication network. Priority is given to MOBILE.

(B) SET IP ADDRESS

This sets up the details of the communication network. Depending on the NETWORK TYPE setting, the contents of setting vary. If setting to NONE, it does not appear.

●ETHER Setting

SET IP ADDRESS 1/1	
->REMOTE ENABLE	(E)
IP ADDRESS(E)	(F)

SUBNET MASK(E)	(G)

EXIT	
CURRENT *****	(I)
*** **	
SELECT WITH SERVICE BUTTON AND PRESS TEST BUTTON	

●MOBILE Setting

SET IP ADDRESS 1/1	
->IP ADDRESS(M)	(H)

EXIT	
CURRENT *****	(I)
*** **	
SELECT WITH SERVICE BUTTON AND PRESS TEST BUTTON	

●ETHER+MOBILE Settings

```

      SET IP ADDRESS 1/1
->REMOTE      ENABLE      (E)
  IP ADDRESS(E)          (F)
  -----
  SUBNET MASK(E)        (G)
  -----
  IP ADDRESS(M)         (H)
  -----
  EXIT

  CURRENT *****      (I)
  ***.***.***.***
  SELECT WITH SERVICE BUTTON
  AND PRESS TEST BUTTON

```

- Use the SERVICE Button to move the cursor to the desired test item.
(When setting IP ADDRESS or SUBNET MASK, use the underline as a guide.)
- Press the TEST Button to change the setting.
- Move the cursor to EXIT and press the TEST Button to return to the NETWORK SETTING screen.

- (E) REMOTE
This sets up whether a communication setting is automatic or manual.
ENABLE: Sets the communication setting automatically.
DISABLL: Sets the communication setting manually.
- (F) IP ADDRESS (E)
This is one of the settings required for communication network. After setting the number, press TEST Button on SET position to memorize the setting. If you set the REMOTE setting to ENABLE, you cannot select this.
- (G) SUBNET MASK (E)
This is one of the settings required for communication network. After setting the number, press TEST Button on SET position to memorize the setting. If you set the REMOTE setting to ENABLE, you cannot select this.
- (H) IP ADDRESS (M)
This is one of the settings required for communication network. Set the number according to the Game Soft manual. After setting the number, press TEST Button on SET position to memorize the setting.
- (I) CURRENT
This displays the present setting value during a setup of each item [(F), (G), (H)]. Pressing TEST Button on SET position, the settings are memorized and the screen is changed.

(C) CLEAR NETWORK SETTING

Use this to return all values in the NETWORK SETTING to the default values and turn off network communication.

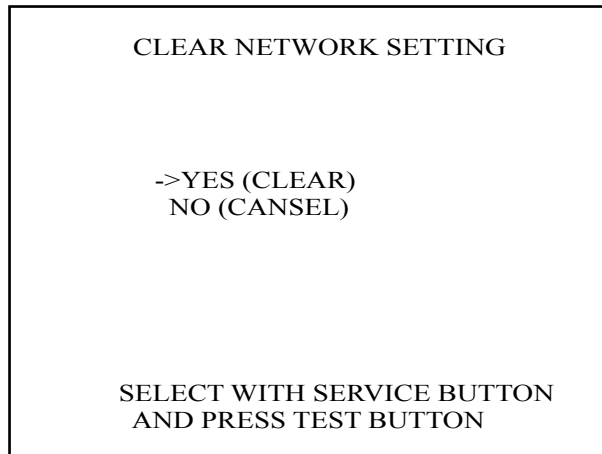

To clear data, use the SERVICE Button to move the cursor to YES (CLEAR) and press the TEST Button. When the data has been cleared, the message "COMPLETED" is displayed.

Press the TEST Button again to return to the NETWORK SETTING main screen.

Move the cursor to NO (CANCEL) and press the TEST Button to return to the NETWORK SETTING main screen without clearing the data.

(D) NETWORK TEST

In this test, the checking for the communication network can be performed. Entering this test mode, checking starts immediately.

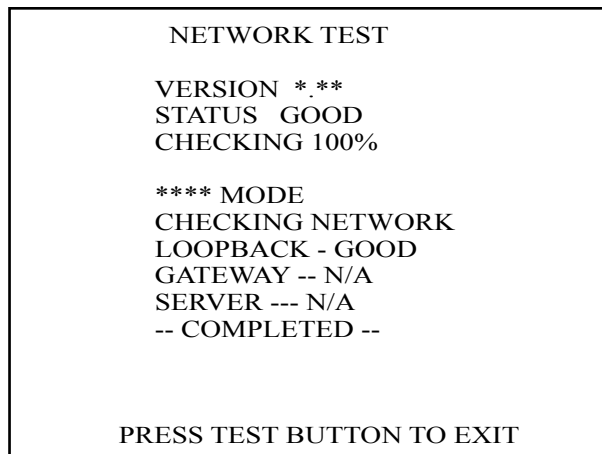

The display changes to "GOOD" when the checking is finished successfully, and changes to "BAD" when any problem is detected. If the connection is not permitted, the display will change to "N/A".

If you perform this test immediately after the setting change, it may not display the correct result. In this case, be sure to turn the power off and on, and enter this test mode again.



- When changing the game configuration, changes will not take effect until the Game Test Mode has been completed. Be sure to exit the Game Test Mode properly after configuration changes.
- Do not configure the game in ways not described in this text. It is possible that the game will not function properly.

Select ENTER GAME TEST from the System Menu screen to display the GAME TEST MENU screen as follows.

Use the SERVICE Button to move the cursor to the desired test item.

Press the TEST Button to enter the selected item's test.

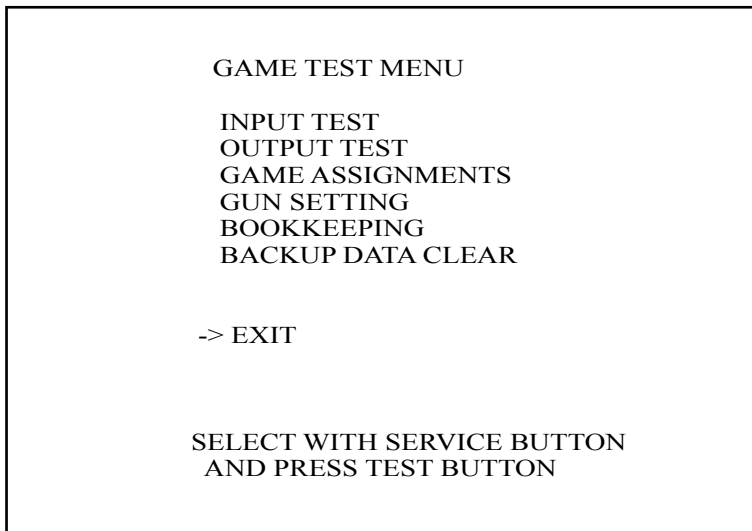

Performs test, adjustments and settings for each of the Game Test Menu screen items below.

- INPUT TEST: Tests each input device used in the game.
- OUTPUT TEST: Tests each output device used in the game.
- GAME ASSIGNMENTS: Adjusts game settings.
- GUN SETTING: Performs sight settings for the game's Control Unit (Shotgun).
- BOOKKEEPING: View all recorded game data.
- BACKUP DATA CLEAR: Erase all game records.

After selecting an item, read the explanations below regarding operation.

After performing tests and adjustments, return to the Game Test Menu screen, select EXIT and press the TEST Button. You will return to the System Menu Screen.

Move the cursor to EXIT on System Menu screen and press the TEST Button to return to the Game Play screen.

a. INPUT TEST

Select INPUT TEST to display the following screen and check the status of input devices. This test should be used periodically to check that each input device is functioning correctly.

INPUT TEST			
	PLAYER1	PLAYER2	
START	OFF	OFF	
TRIGGER	OFF	OFF	
GRIP	OFF	OFF	
GUN-X	00	00	
GUN-Y	00	00	
SCREEN-IN	OUT	OUT	
SERVICE	OFF		
TEST	OFF		

PRESS TEST AND SERVICE BUTTON TO EXIT

The items refer to the following input devices.

- **START:** The player START Buttons.
 - **TRIGGER:** The gun triggers.
 - **GRIP:** The gun grips.
 - **GUN-X:** The X-direction (horizontal) sight position for the guns.
 - **GUN-Y:** The Y-direction (vertical) sight position for the guns.
 - **SCREEN-IN:** Detection of the gun sight sensors.
 - **SERVICE:** The SERVICE Button.
 - **TEST:** The TEST Button.
- Input is normal if the display to the right of each item changes from OFF to ON when each input device is operated.
 - Input is normal if the display to the right of SCREEN-IN changes from OUT to IN when the shotgun is pointed at the screen.
 - Input is normal if the display values to the right of GUN-X and GUN-Y change according to the movement of the guns when they are pointed at the screen and moved.

Press the SERVICE and TEST Buttons simultaneously to return to the Game Test Menu screen.

b. OUTPUT TEST

Select OUTPUT TEST to display the following screen and check the status of each lamp. This test should be used periodically to check that the lamps are functioning correctly.

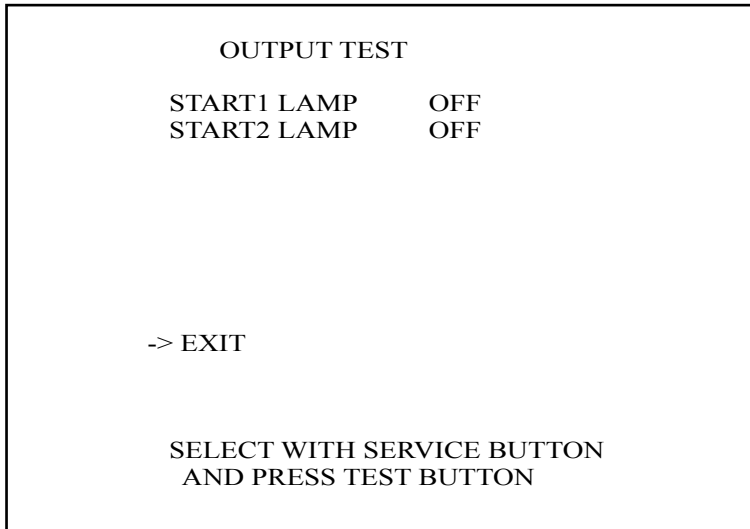

Perform the tests as follows.

- **START1 LAMP:** Select START1 LAMP and press the TEST Button or START Button 1. The display to the right of the item will change to ON and START Button 1 will flash.
- **START2 LAMP:** Select START2 LAMP and press the TEST Button or START Button 2. The display to the right of the item will change to ON and START Button 2 will flash.

Move the cursor to EXIT and press the TEST Button to return to the Game Test Menu screen.

c. GAME ASSIGNMENTS

Select GAME ASSIGNMENTS to display the current game settings and make changes.

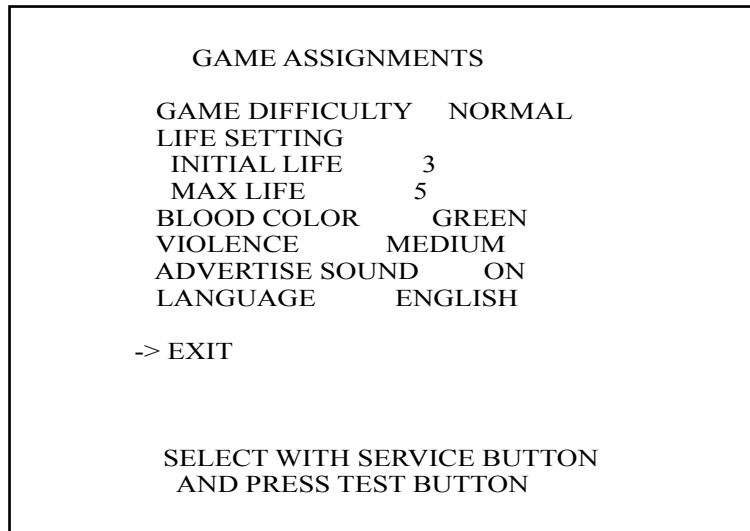

Perform the following settings for each item.

- **GAME DIFFICULTY:** Set the level of difficulty to one of five levels — VERY EASY-MEDIUM EASY-NORMAL-MEDIUM HARD-VERY HARD.
- **LIFE SETTING INITIAL LIFE:** Set from one to nine. It is not possible to set this above MAX LIFE.
- **LIFE SETTING MAX LIFE:** Set from one to nine.
- **BLOOD COLOR:** You can set the color of blood to one of two settings — RED or GREEN.
- **VIOLENCE:** You can set the level of damage for the enemies to one of three settings — GRATUITOUS, MEDIUM or MILD.
- **ADVERTISE SOUND:** You can set the advertise sound to ON or OFF.
- **LANGUAGE** *(Only displayed for overseas versions outside of the United States.): The selections are ENGLISH, FRENCH, ITALIAN, SPANISH and GERMAN. The subtitles and displays that appear during the game will change to the selected language.

Changes to settings are not enabled until Test Mode is exited. After changing settings, be sure to exit Test Mode.

After changing the settings, select EXIT and press the TEST Button to return to the Game Test Menu screen.

d. GUN SETTING

Select GUN SETTING to display the following screen.
Perform the sight settings for the shotguns to be used in the game.

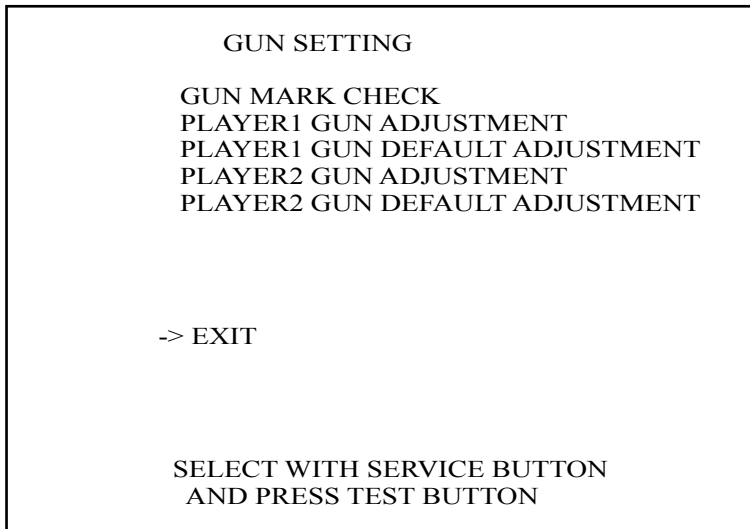

Details for each item are as follows.

- GUN MARK CHECK: Checks the gun sights. Will check 1P and 2P guns at the same time.
- PLAYER1 GUN ADJUSTMENT: Adjusts the sight for the Player 1 side.
- PLAYER1 GUN DEFAULT ADJUSTMENT: Adjust the default sight settings for the Player 1 side.
- PLAYER2 GUN ADJUSTMENT: Adjust the sight for the Player 2 side. (Operated in the same way as PLAYER1 GUN ADJUSTMENT.)
- PLAYER2 GUN DEFAULT ADJUSTMENT: Adjust the default sight settings for the Player 2 side. (Operated in the same way as PLAYER1 GUN DEFAULT ADJUSTMENT.)

Changes to settings are not enabled until the Test Mode is exited. After changing settings, be sure to exit Test Mode.

After changing the settings, select EXIT and press the TEST Button to return to the Game Test Menu screen.

d-1. GUN MARK CHECK

This item checks gun sights.

Select GUN MARK CHECK on the Gun Setting screen and press the TEST Button.

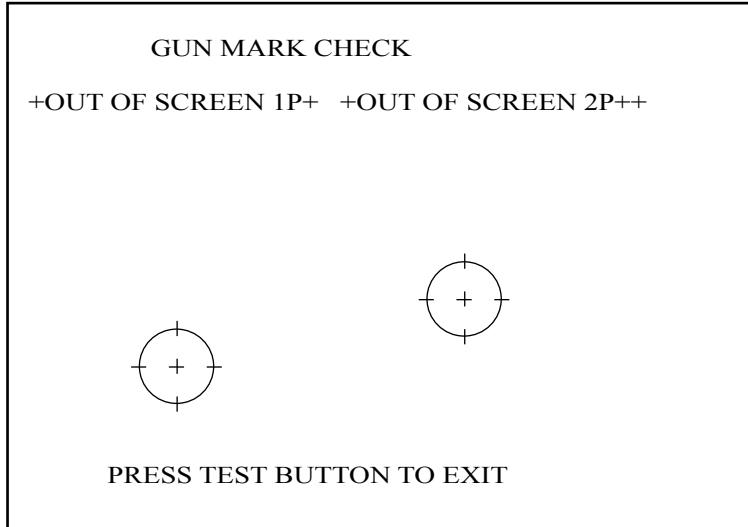

- (1P Gun cross)
This is displayed when the gun is pointed at the screen. 1P is red.
- (2P Gun cross)
This is displayed when the gun is pointed at the screen. 2P is blue.
- "OUT OF SCREEN" is displayed when the gun cross is perceived to be out of screen.

Pointing the gun at the screen displays the gun cross (sight) for that gun. You can check to see if the sight lines up properly at this screen.

Press the TEST Button when everything has been checked. You will return to the Gun Setting screen.

d-2. PLAYER1 GUN ADJUSTMENT/PLAYER2 GUN ADJUSTMENT

This item adjusts the Player 1 gun sight.
(This is the same for "PLAYER2 GUN ADJUSTMENT".)

- Select PLAYER1 GUN ADJUSTMENT on the Gun Setting screen and press the TEST Button.

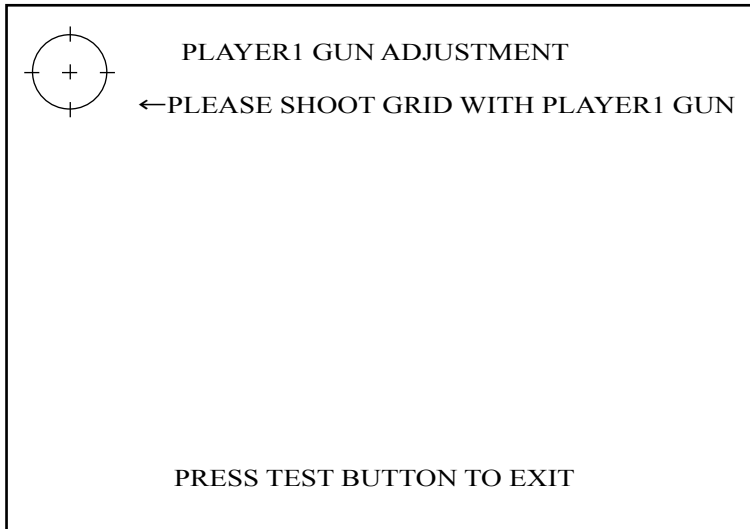

- Follow the on-screen instructions to adjust the gun sight settings. Aim at the mark in the upper left corner and fire. The mark in the upper left will disappear, and the same mark will be displayed in the lower right corner.
(If the TEST Button is pressed, settings will be canceled and will return to the Gun Setting screen.)

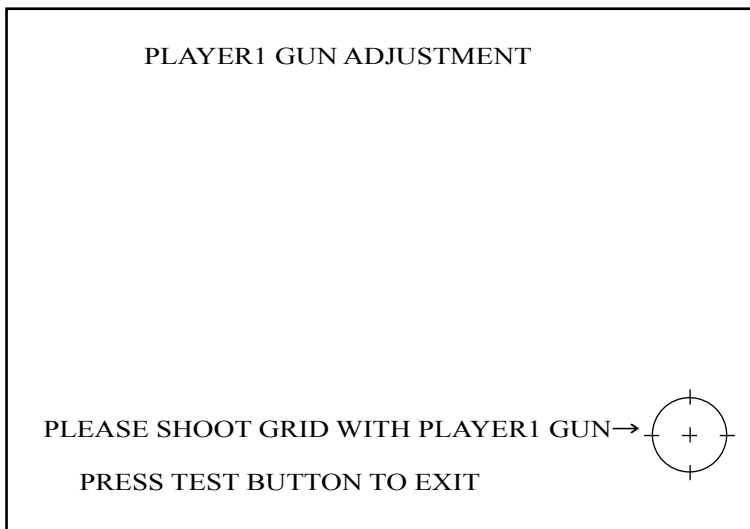

- Aim and fire at the mark to the lower right. The mark to the lower right will disappear, and the same mark will be displayed in the center.
(If the TEST Button is pressed, settings will be canceled and will return to the Gun Setting screen.)

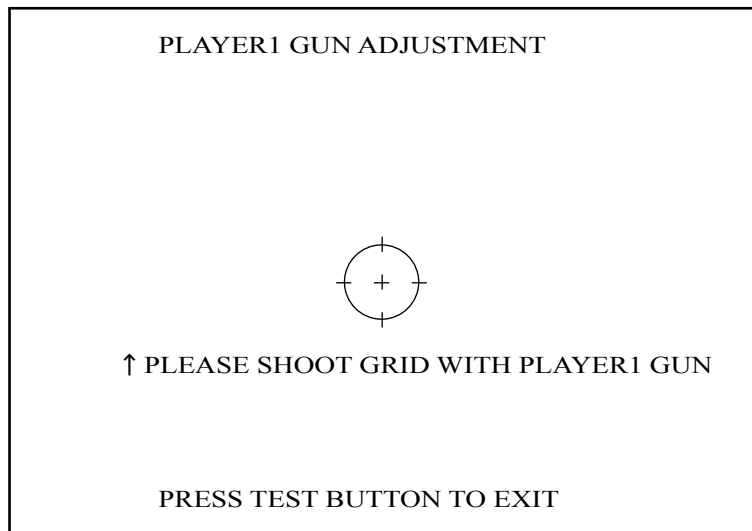

- Aim and fire at the mark in the center. "NOW CALCULATING" will be displayed in the center.
(If the TEST Button is pressed, settings will be canceled and will return to the Gun Setting screen.)

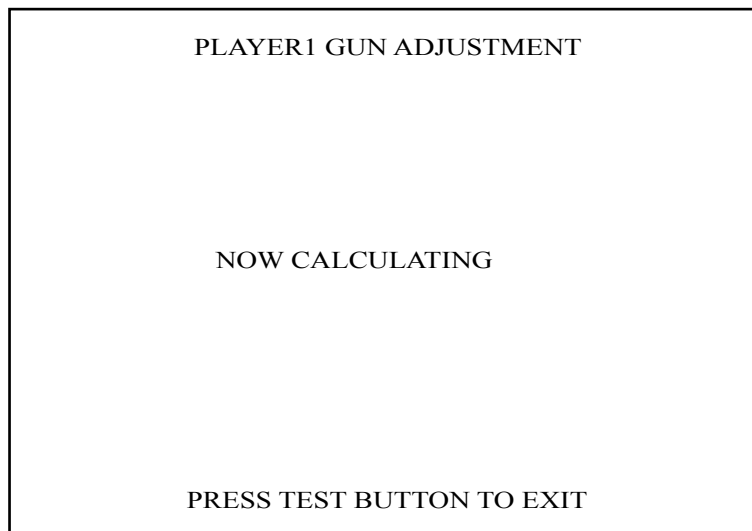

- The screen will automatically switch to the following.

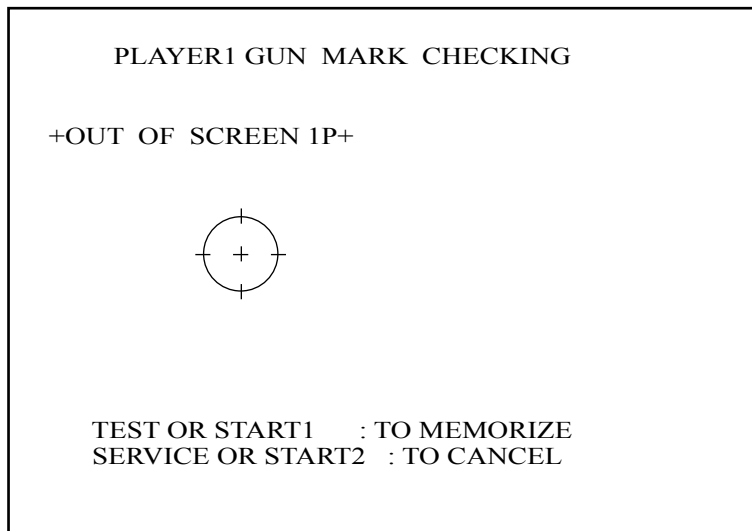

- "OUT OF SCREEN" is displayed when the gun cross is perceived to be out of screen.
- The gun cross is displayed in the center. Confirm that you can aim accurately within the frame, from edge to edge.
 - When a sight is out of alignment, press the SERVICE Button or the 2P Start Button and readjust the settings. You will return to the Gun Setting screen.
 - If the sights are aligned, press the TEST Button or the 1P Start Button to record the sight settings.

Refer to the following procedure when adjusting the sights.

- Line up the concave sight nearest you on the gun so that it is at the height of the horizontal line of the "+" mark.
- Line up the convex sight at the tip of the gun so that it also lines up with the horizontal line.
- Line up the centers of the tops of the concave and convex sights with the center of the "+" and fire.

d-3. PLAYER1 GUN DEFAULT ADJUSTMENT/PLAYER2 GUN DEFAULT ADJUSTMENT

This item adjusts the sight settings to those at the time of shipment.
(This is the same for "PLAYER2 GUN DEFAULT ADJUSTMENT".)

Select PLAYER1 GUN DEFAULT ADJUSTMENT on the Gun Setting screen and press the TEST Button.

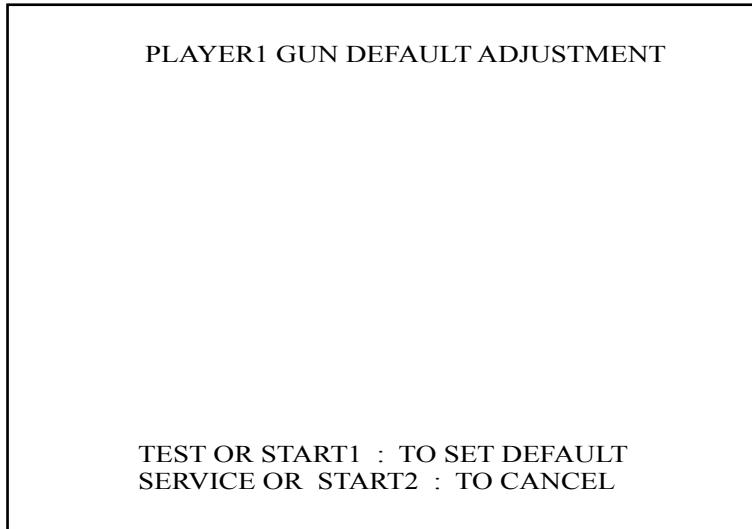

Press the TEST Button or the Player 1 Start Button to adjust the sights to the previously established default value. Press the SERVICE Button or the Player 2 Start Button to cancel.

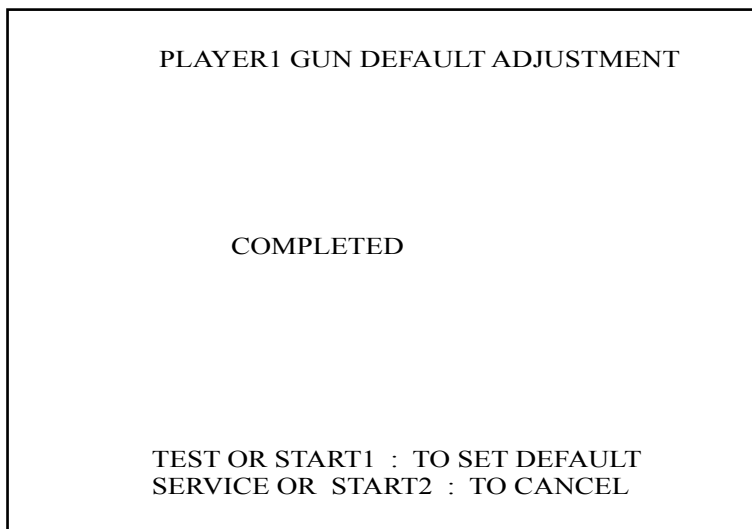

"COMPLETED" will be displayed when the adjustments are completed.

e. BOOKKEEPING

Select BOOKKEEPING on the Game Test Menu screen to display the three screens of operating status data.

BOOKKEEPING	PAGE1/3
COIN 1	0
COIN 2	0
TOTAL COINS	0
COIN CREDITS	0
SERVICE CREDITS	0
TOTAL CREDITS	0
PRESS TEST BUTTON TO CONTINUE	

The display items for the screen (Page 1 of 3) are as follows.

- COIN 1: The number of coins inserted into Coin Slot 1.
- COIN 2: The number of coins inserted into Coin Slot 2.
- TOTAL COINS: The total number of coins inserted into the coin slots.
- COIN CREDITS: The number of credits for the coins inserted.
- SERVICE CREDITS: The number of credits input by the Service Button.
- TOTAL CREDITS: The total number of all credits.

Press the TEST Button to display the next screen.

BOOKKEEPING		PAGE2/3
NUMBER OF GAMES	0	
TOTAL TIME	0D 0H 0M 0 S	
PLAY TIME	0D 0H 0M 0S	
AVERAGE PLAY TIME	0M 0S	
LONGEST PLAY TIME	0M 0S	
SHORTEST PLAY TIME	0M 0S	
PRESS TEST BUTTON TO CONTINUE		

The display items for the screen (Page 2 of 3) are as follows.

- NUMBER OF GAMES: The total number of games played by 1P and 2P.
- TOTAL TIME: The amount of time the unit has been in operation.
- PLAY TIME: The amount of time the game has been played.
- AVERAGE PLAY TIME: The average play time for one game.
- LONGEST PLAY TIME: The longest play time for one game.
- SHORTEST PLAY TIME: The shortest play time for one game.

Press the TEST Button to display the next screen.

BOOKKEEPING		PAGE3/3
GAME HISTOGRAM		
0M 00S ~ 0M 29S	0000	
0M 30S ~ 0M 59S	0000	
1M 00S ~ 1M 29S	0000	
1M 30S ~ 1M 59S	0000	
2M 00S ~ 2M 29S	0000	
2M 30S ~ 2M 59S	0000	
3M 00S ~ 3M 29S	0000	
3M 30S ~ 3M 59S	0000	
4M 00S ~ 4M 29S	0000	
4M 30S ~ 4M 59S	0000	
5M 00S ~ 5M 29S	0000	
5M 30S ~ 5M 59S	0000	
6M 00S ~ 6M 29S	0000	
6M 30S ~ 6M 59S	0000	
7M 00S ~ 7M 29S	0000	
7M 30S ~ 7M 59S	0000	
8M 00S ~ 8M 29S	0000	
8M 30S ~ 8M 59S	0000	
9M 00S ~ 9M 29S	0000	
9M 30S ~ 9M 59S	0000	
OVER 10M 00S	0000	
PRESS TEST BUTTON TO EXIT		

This displays play times on a scale from 0M00S to 9M59S with 30-second intervals. All play times over ten minutes are included in the item OVER 10M00S.

Press the TEST Button after viewing. You will return to the Game Test Menu screen.

f. BACKUP DATA CLEAR

Select BACKUP DATA CLEAR to clear the contents of BOOKKEEPING and Score Data.

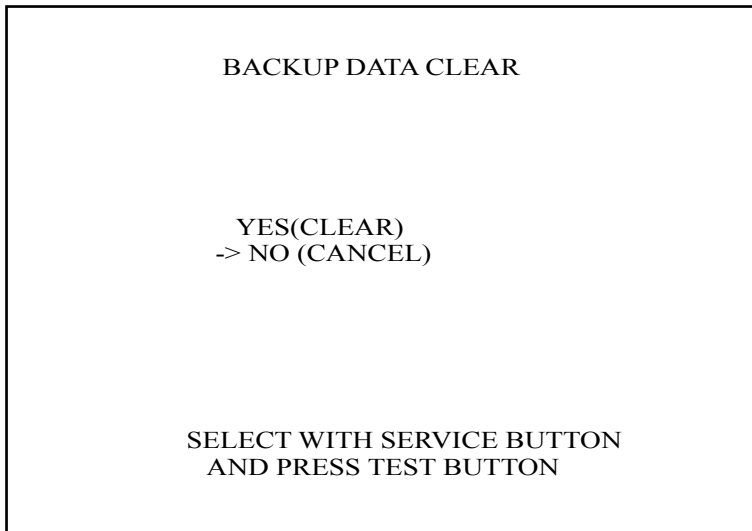

BACKUP DATA CLEAR Screen

To clear data, use the SERVICE Button to move the cursor to YES (CLEAR) and then press the TEST Button.

When the data has been cleared, the message "COMPLETED" will be displayed.

Press the TEST Button again to return to the Game Test Menu screen.

Move the cursor to NO (CANCEL) and press the TEST Button to return to the Game Test Menu screen without clearing the data.

Note that this operation does not affect the settings of the GAME ASSIGNMENTS and the GUN ADJUSTMENT.

Using the BACKUP DATA CLEAR function from this screen will not affect coin/credit data. To clear coin/credit data, use the BACKUP DATA CLEAR function in SYSTEM TEST MODE.

8. CONTROL UNIT (SHOTGUN)



- In order to prevent an electric shock and short circuit, be sure to turn power off before performing work by touching the interior parts of the product.
- Be careful not to damage the wires. Damaged wires may cause electric shock or short circuit or present a fire risk.
- Be very careful when soldering. Handling a soldering iron carelessly may result in a fire or a burn.



When securing the plastic-made parts, do not excessively fasten screws and nuts. Failure to observe this may damage the parts and cause injury due to fragments resulting from damage.



- Do not cut the tie belt securing the wires in the Control Unit (Shotgun). Cutting the tie belt may cause malfunctioning of the wire connection. If you cut the tie belt when replacing the wire etc., be sure to secure the wires using a new tie belt as before.
- After removing 4 bind screws once, retighten them by using the designated threadlocking agent (Part Number: 090-0012). If the threadlocking agent is not used, the reassembled shotgun may rattle or come apart.
- Use only the threadlocker designated in this manual. Use of other threadlocking agents may cause chemical reactions that could damage the screws or part's surface.

In the cases where the gun's operation is not satisfactory or the gun sight deviates from the direction in which the control unit is pointed, the gun's interior parts may have been damaged. Replace the parts by disassembling the gun in the following procedure: Also, be sure to perform sighting check in the test mode when the gun parts are replaced.

REPLACING THE MICROSWITCH

To replace parts in the Shotgun, it is necessary to separate the two halves of the outer case cover. Internal parts are inserted directly into the right side of the cover, so the procedure should be carried out with the right half downmost.

- Turn the power OFF.
- Remove the 2 BIND screws from each side and remove the left and right Slide Grips.
- To separate the left and right halves of the cover, remove the 3 (M3×8) screws and the 12 (M3×16) screws. Be aware that 1 (M3×16) screw is in the right side of the cover. Therefore, remove the 1 screw on the right half of the cover first, before removing the rest of the screws, with the right half downmost.

- With the right half downmost, remove the left half.
- Pull the trigger side macroswitch out of the right cover.

- Remove the solder and remove the macroswitch.
- The pump action side macroswitch is contained in the slide mechanism.
Pull the slide mechanism out from the right cover.

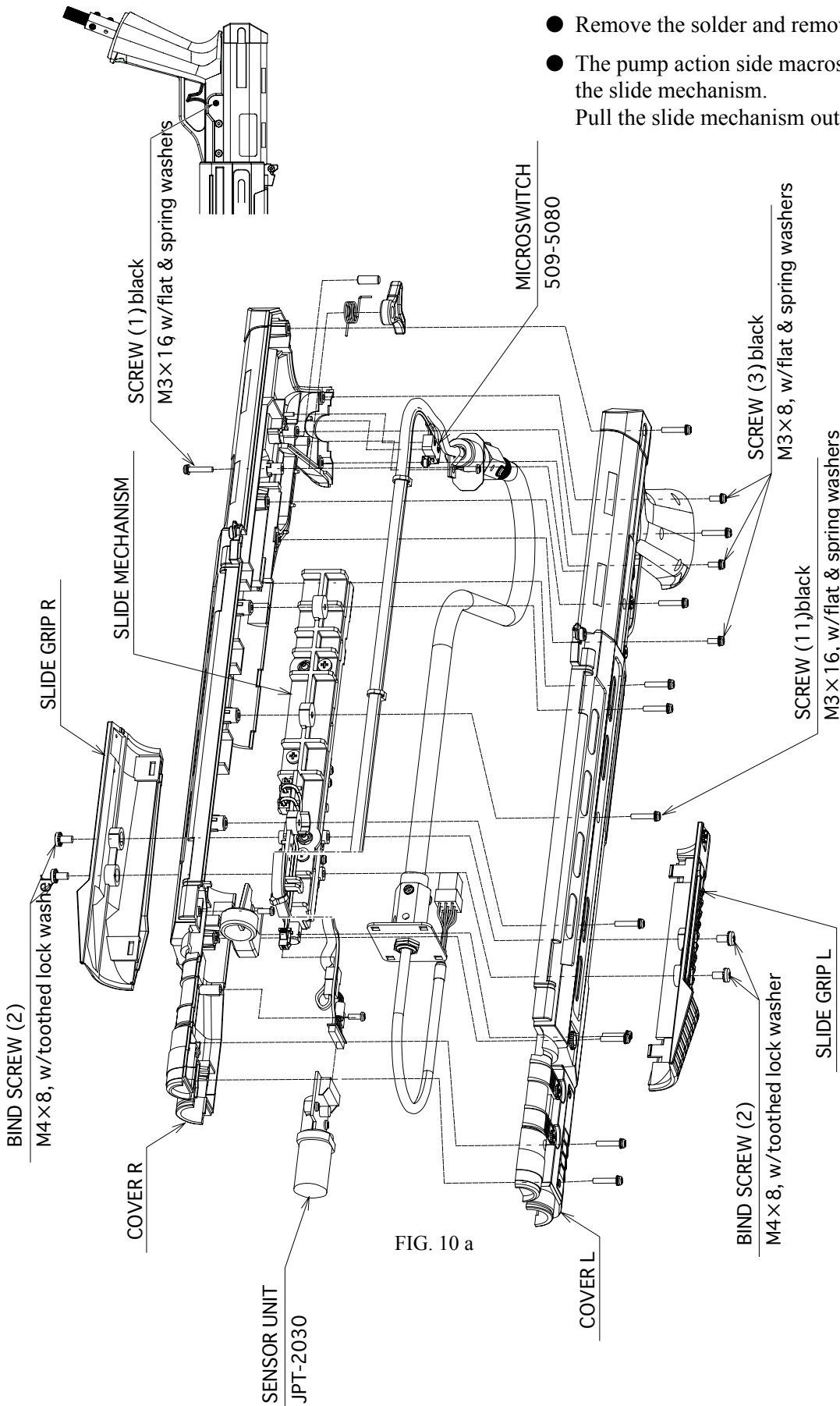

FIG. 10 a

- Remove the 2 tapping screws, and remove the microswitch from the slide mechanism.
- Remove the solder and remove the microswitch.

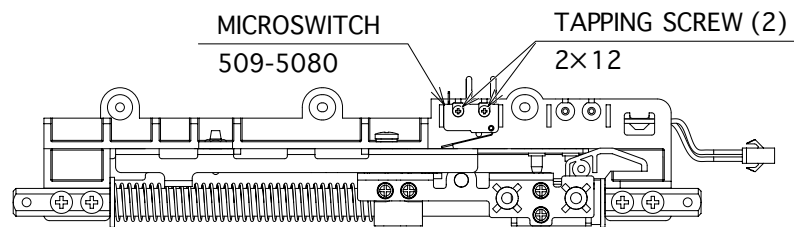

FIG. 10 b SLIDE MACHANISM

- Solder in the new microswitch, and assemble the Shotgun. When assembling, be careful not to over-tighten the screws. Be especially careful when tightening the tapping screws.
- Operate the trigger and grip, and make sure that the macroswitch turns ON/OFF correctly.

REPLACING THE SENSOR UNIT

- Follow first 3 steps of "Replacing the Microswitch." Remove the Cover L.
- Disconnect the connector and remove the Sensor Unit. Remove the tapping screw, when you are hard to work.

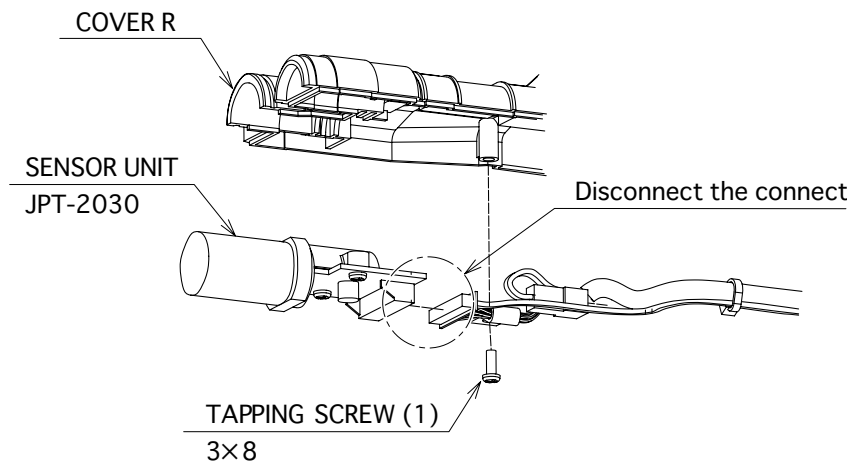

FIG. 10 c

9. MONITOR

9-1 CAUTIONS AND WARNINGS CONCERNING THE SAFETY FOR HANDLING THE MONITORS

Before handling the monitors, be sure to read the following explanations and comply with the caution/warning instructions given below. Note that the caution/warning symbol marks and letters are used in the instructions.



Indicates that handling the monitors erroneously by disregarding this warning may cause a potentially hazardous situation, which could result in death or serious injury.



Indicates that handling the monitors by disregarding this caution may cause a potentially hazardous situation, which could result in personal injury and or material damage.



Indicates that access to a specific part of the equipment is forbidden.



Indicates the instruction to disconnect a power connector or to unplug.



- When performing such work as installing and removing the monitor, inserting and disconnecting the external connectors to and from monitor interior and the monitor, be sure to disconnect the power connector (plug) before starting the work. Proceeding the work without following this instruction can cause electric shock or malfunctioning.
- Using the monitor by converting it without obtaining a prior permission is not allowed. SEGA shall not be liable for any malfunctioning and accident caused by said conversion.



- Primary side and Secondary side
The monitor's circuit which is divided into the Primary side and Secondary side, is electrically isolated. Do not touch the primary side, or do not touch both the primary side and the secondary side simultaneously. Failing to observe the instruction can cause electric shock and this is very dangerous. When making monitor adjustments, use a non-conductive driver and make adjustment without touching any part other than the Adjustment V. R. and knob. Also, be sure not to cause a short-circuit to the Primary side and Secondary side. If short-circuited, it can cause electric shock or malfunctioning, which is very dangerous.
- High-tension Voltage
Some of the parts inside monitor are subject to high-tension voltage in excess of 20,000 volts and very dangerous. Therefore, do not touch the monitor interior. Should soldering & paper wastes, etc. be mixed in the monitor interior, turn the power off so as not to cause malfunctioning or fire hazard.

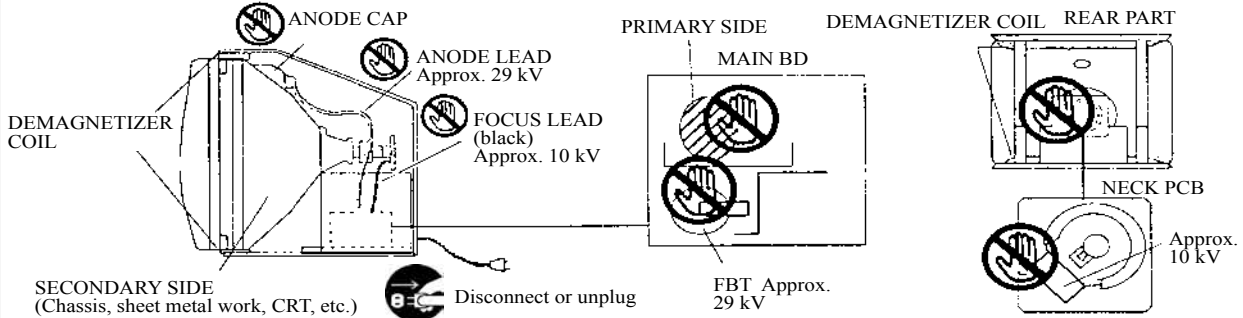
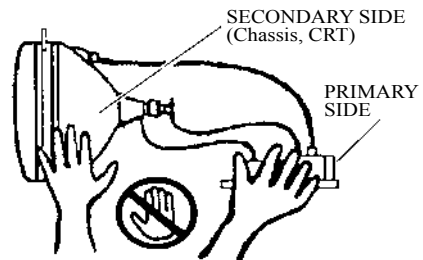

- Connecting the CRT and PCB
For combining the CRT and PCB, use the specified part No. to maintain the status of adjustments made at the factory. The anode of the CRT itself will be accumulatively charged as time elapses, generating high-tension voltage which is very dangerous. The monitor should be used with the Chassis, CRT and PCB assembled. When repair, etc. is required at the time of malfunctioning, be sure to send it in an "as is assembled" condition. If these are disassembled, what's charged to said high tension voltage can be discharged, causing a very hazardous situation. Therefore, under no circumstances should it be disassembled.



- Static Electricity
Touching the CRT surface sometimes causes you to slightly feel electricity. This is because the CRT surfaces are subject to static and will not adversely affect the human body.
- Installation and removal
Ensure that the Magnetizer Coil, FBT (Fly-Back Transformer), Anode Lead and Focus Lead are not positioned close to the sheet metal work's sharp edges, etc. and avoid damaging the insulated portions so as not to cause electric shock and malfunctioning. (For the name of parts, refer to the above Figures).



For the purpose of static prevention, special coating is applied to the CRT face of this product. To protect the coating, pay attention to the following points. Damaging the coating film can cause electric shock to the customers.

- Do not apply or rub with a hard item (a rod with pointed edge, pen, etc.) to or on the CRT surfaces.
- Avoid applying stickers, seals, etc. on the CRT face.
- Do not remove aluminum foils from the CRT corners. Removing the aluminum foils can cause static prevention effects to be lowered.

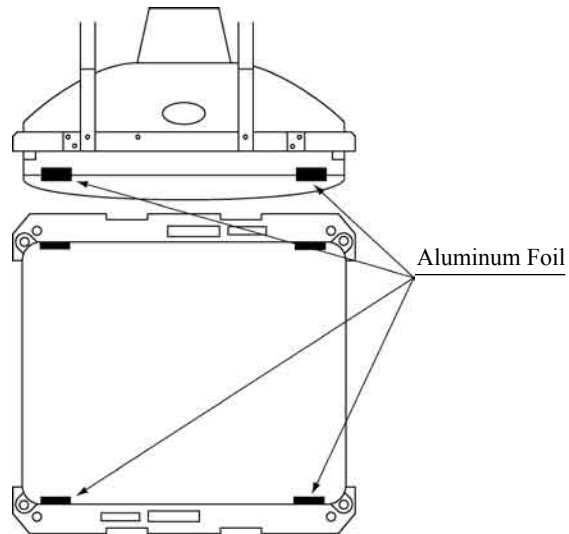

9-2 CLEANING THE CRT SURFACES



Static preventive coating is applied to the CRT surfaces. When cleaning, pay attention to the following points. Peeling off of static preventive coat can cause electric shock.

- Remove smears by using a dry, soft cloth (flannels, etc.). Do not use a coarse gauze, etc.
- For smear removing solvent, alcohol (ethanol) is recommended. When using chemical detergent, be sure to follow instructions below:
 - Dilute chemical detergent with water and dip a soft cloth in and then thoroughly wring it to wipe smears off.
 - Do not use a chemical detergent containing an abradant, powder or bleaching agent.
 - Do not use alkaline chemical detergents such as "glass cleaner" available on the market or solvents such as thinner, etc.
- Do not rub or scratch the CRT face with hard items such as brushes, scrub brush, etc.

Clean the CRT surfaces once a week. When cleaning, pay attention to the above caution so that the antistatic coating will not come off.

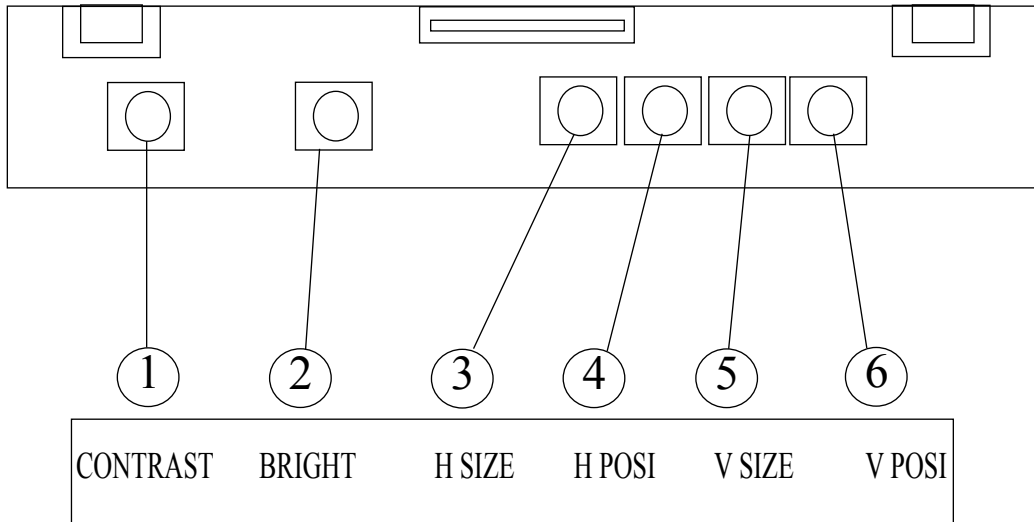

- ① CONTRAST..... Adjust image contrast.
- ② BRIGHT..... Controls screen brightness.
- ③ H. SIZE.....Controls horizontal screen size.
- ④ H. POSI.....Controls horizontal display position on screen.
- ⑤ V. SIZE.....Controls vertical screen size.
- ⑥ V. POSI.....Controls vertical display position on screen.

10. COIN SELECTOR

HANDLING THE COIN JAM

If the coin is not rejected when the REJECT button is pressed, open the coin chute door and open the selector gate. After removing the jammed coin, put a normal coin in and check to see that the selector correctly functions.

CLEANING THE COIN SELECTOR



- Remove and clean smears by using a soft cloth dipped in water or diluted chemical detergent and then squeezed dry.
- Never apply machine oil, etc. to the Coin Selector.
- After cleaning the Coin Selector, insert a regular coin in the normal working status and ensure that the Selector correctly functions.

The coin selector should be cleaned once every 3 months. When cleaning, follow the procedure below:

- ① Turn the power for the machine OFF. Open the coin chute door.
- ② Open the gate and dust off by using a soft brush (made of wool, etc.).
- ③ Remove and clean smears by using a soft cloth dipped in water or diluted chemical detergent and then squeezed dry.
- ④ Remove the CRADLE.
When removing the retaining ring (E ring), be very careful so as not to bend the rotary shaft.
- ⑤ Remove stain from the rotary shaft and shaft receiving portions by wiping off with a soft cloth, etc.
- ⑥ After wiping off as per ⑤ above, further apply a dry cloth, etc. to cause the coin selector to dry completely.

COIN INSERTION TEST

Once every month, when performing the Coin SW Test, simultaneously check the following:

- Does the Coin Meter count satisfactorily?
- Does the coin drop into the Cashbox correctly?
- Is the coin rejected when inserted while keeping the Reject Button pressed down?

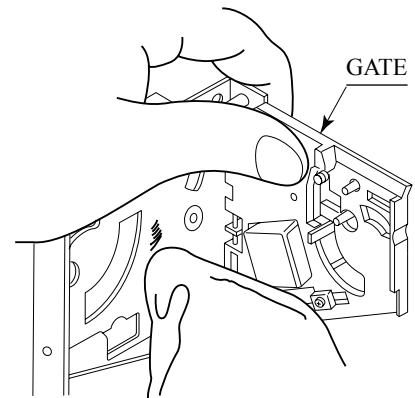

FIG. 12 a

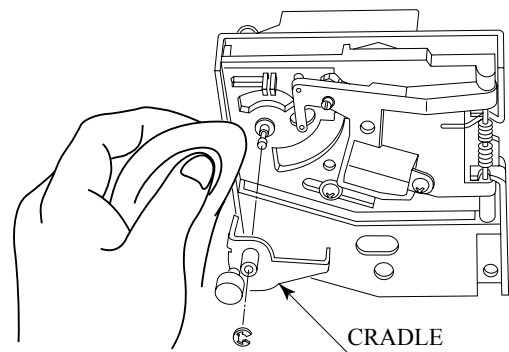

FIG. 12 b

Insert a coin while keeping the Reject Button pressed down and check if it is rejected.

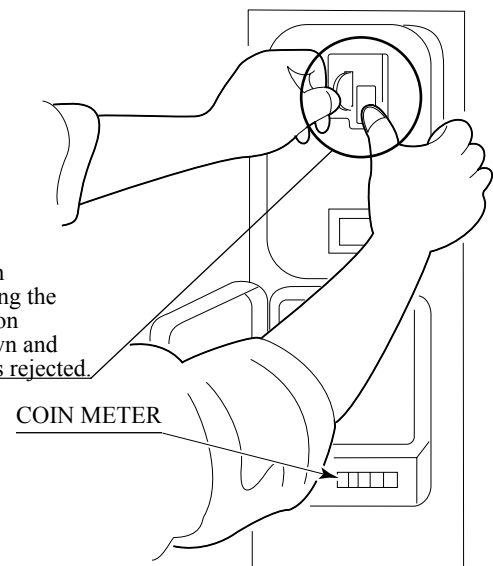
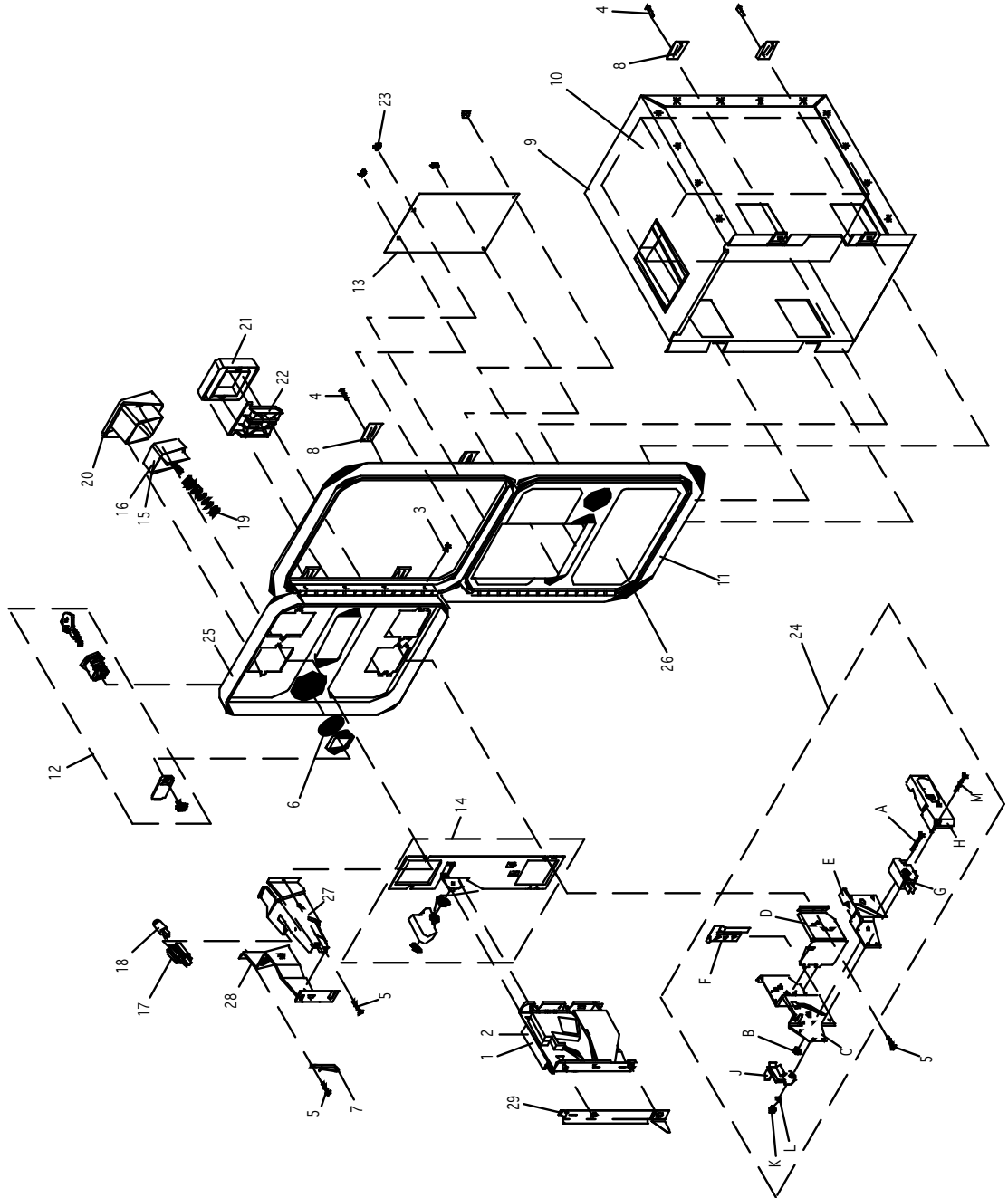

FIG. 12 c

WGD15-2110-01
 OVER/UNDER MINI DOOR
 2 ENTRIES WITH BILL
 VALIDATOR BOTTOM DOOR
 & SPECIAL ENCLOSURE

WELLS-GARDNER
 ELECTRONICS CORPORATION
 2701 N. KILDARE CHICAGO, IL 60639
 1-800-336-6630
 WWW.WGEC.COM

#	W/G. PART #	DESCRIPTION
1	812-4150-011	S-7 US 25c COIN MECH LEFT
2	812-4050-011	S-10 US \$1 COIN MECH RIGHT
3	890-1002-00	HINGE SCREW
4	890-1003-00	CLAMP SCREW
5	890-1017-00	SCREW TRILOBULAR
6	890-1019-00	WASHER INTERNAL TOOTH 3/4"
7	890-1300-00	KEYHOOK
8	891-0517-00	CLAMP UK 5/8" CABINET
9	025X3711-001	ENCLOSURE W/CHUTE
10	025X3712-001	METAL CASHBOX
11	891-0509-162	DOUBLE FRAME
12	891-0547-00	LOCK SINGLE BIT
13	891-0100-4016	COVER PLATE
14	891-1008-107	BASE PLATE ASSEMBLY
15	891-1113-03	E/R BUTTON US 4x25c \$1 LEFT
16	891-1113-011	E/R BUTTON US \$1 COIN RIGHT
17	891-1117-00	LAMP HOLDER
18	891-1118-00	LAMP WEDGE BASE 6 VOLT
19	891-1121-00	SPRING, E/R BUTTON
20	891-1311-16	BUTTON BEZEL, NYLON
21	891-1312-16	REFLECT BEZEL, NYLON
22	891-1109-16	REFLECT FLAP
23	020X1877-005	NUT KEYS #8 X 3/16 HEX
24	891-2216-16	MICROSWITCH ASSEMBLY
24A	890-1007-00	SCREW FLAT HEAD M/S
24B	890-1206-02	KEEP NUT
24C	891-1105-01	REFLECT CLIP SIDE PLATE
24D	891-1106-00	REFLECT CLIP BASE PLATE
24E	891-1107-00	BRACKET, MICROSWITCH
24F	891-1110-00	ADJUSTER, COIN
24G	891-1116-16	MICROSWITCH BLACK - MED.
24H	891-1125-00	COVER PLASTIC
24J	892-1002-07	CLIP, SNAP-ON
24K	892-1002-08	ELASTIC SNAP NUT
24L	892-1002-09	SLEEVE, SNAP-ON
24M	892-1002-11	SCREW, PAN HEAD
25	891-0804-16	MINI DOOR 2 ENTRIES
26	891-0814-16	MINI DOOR W/DBV/C/O
27	892-1002-01	BRACKET, LAMP SIDE
28	892-1002-021	BRACKET, COVERSIDE
29	892-1002-10	BRACKET, HOLD DOWN



COIN DOOR

Tom Happ
 tom.happ@happcontrols.com
 Happ Controls
 106 Garlich Drive
 Elk Grove, IL. 60007
 Ph. 847-593-6161 ext. 107
 Fx. 847-956-2091

Visit our website <http://www.happcontrols.com>

EXCLUSIVE!

Custom "Guardian" Security Hasp available to protect your dollars,

GUARDIAN

MECH HOLDER PARTS	
MECH HOLDER W/COIN SWITCH	42-3319-00
MECH HOLDER W/O COIN SWITCH	42-7355-00
COIN SWITCH	42-7087-00
SCREW FOR COIN SWITCH	43-0136-00
METAL CLIP	42-7338-91
THUMBSCREW FOR METAL CLIP	42-7338-90

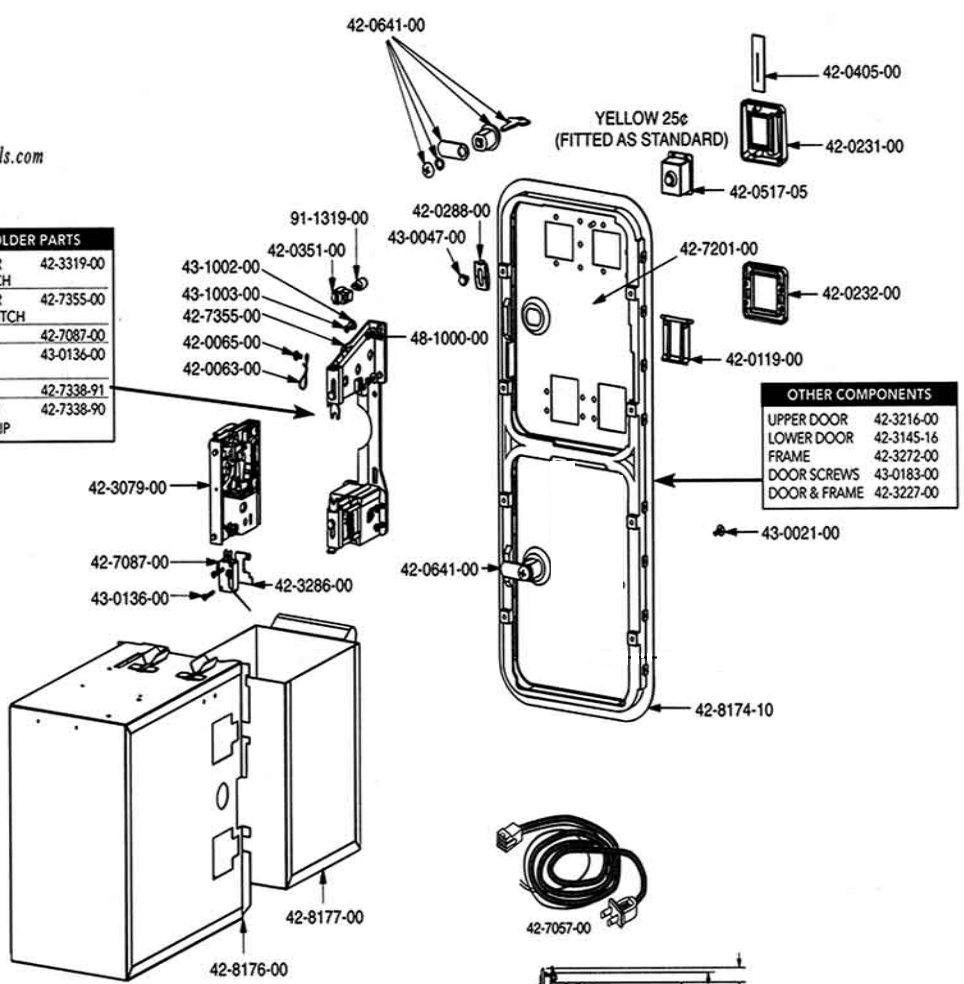

OTHER COMPONENTS	
UPPER DOOR	42-3216-00
LOWER DOOR	42-3145-16
FRAME	42-3272-00
DOOR SCREWS	43-0183-00
DOOR & FRAME	42-3227-00

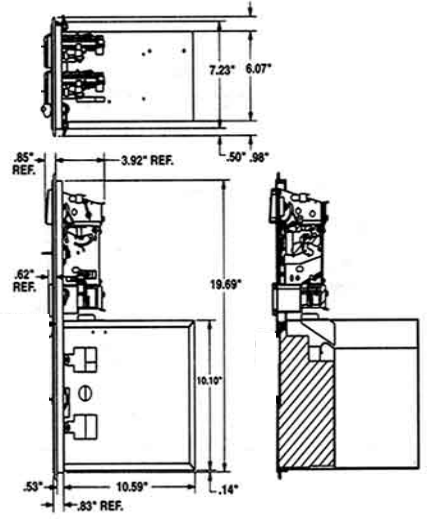
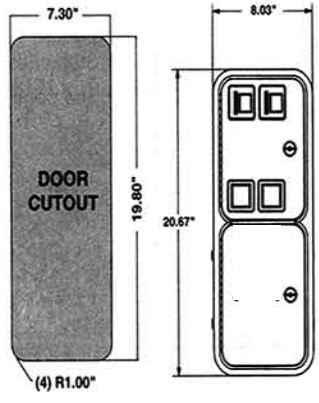
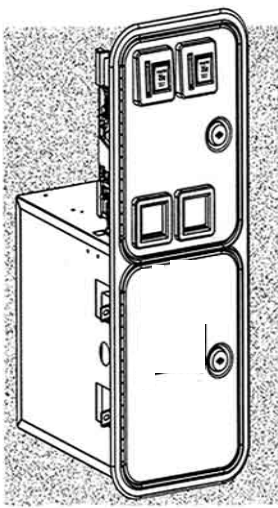

11. DESIGN RELATED PARTS

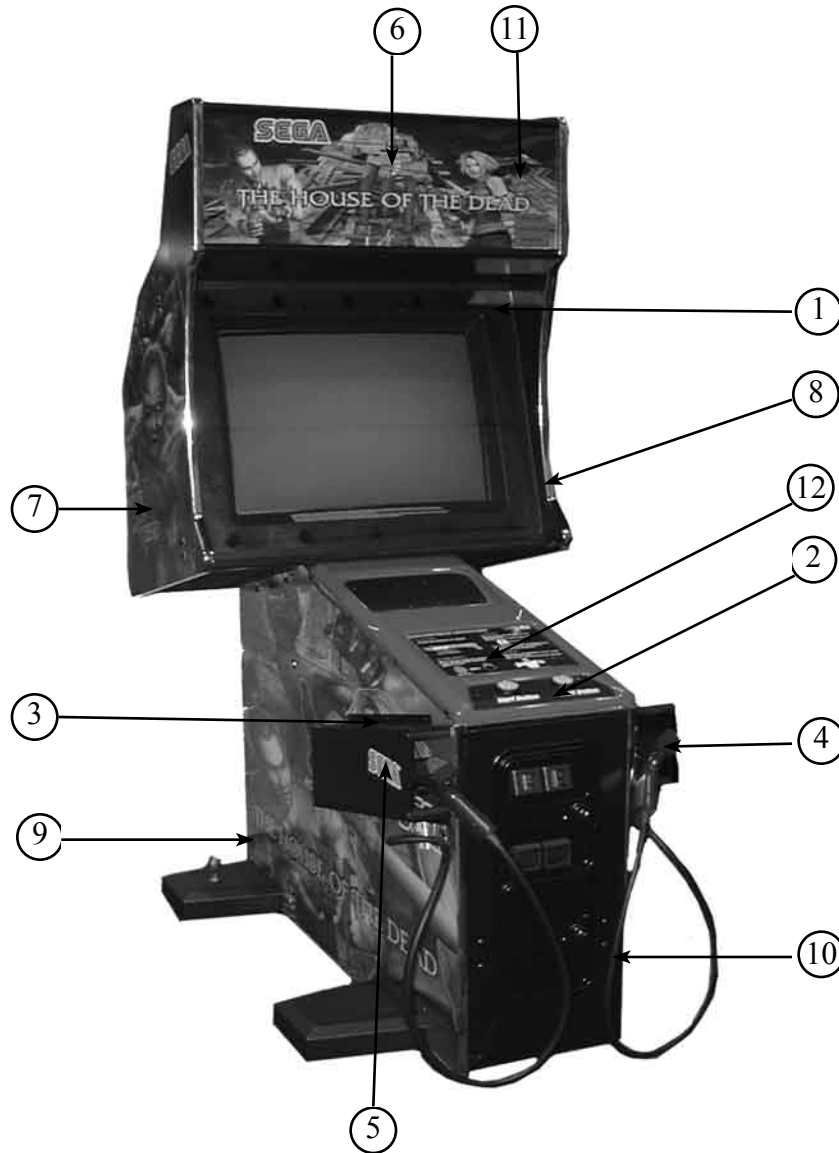

ITEM NO.	PART NO.	DESCRIPTION	NOTE
1	999-1430	LABEL EPILEPSY WARNING SEGA	
2	999-1607	DECAL-START BUTTON	
3	999-1609	DECAL-GUN HOLDER TOP	
4	999-1610	DECAL-GUN HOLDER RIGHT SIDE	
5	999-1611	DECAL-GUN HOLDER LEFT SIDE	
6	999-1661	MARQUEE	
7	999-1662	DECAL-LEFT SIDE MONITOR	
8	999-1663	DECAL-RIGHT SIDE MONITOR	
9	999-1664	DECAL LEFT SIDE MAIN CABINET	
10	999-1665	DECAL RIGHT SIDE MAIN CABINET	
11	999-1666	UNDERLAY STYRENE MARQUEE	
12	999-1608	DECAL-CONTROL PANEL INSTRUCTIONS	

12. PARTS

① CONTROL UNIT (HDT-2100)

D-1/2

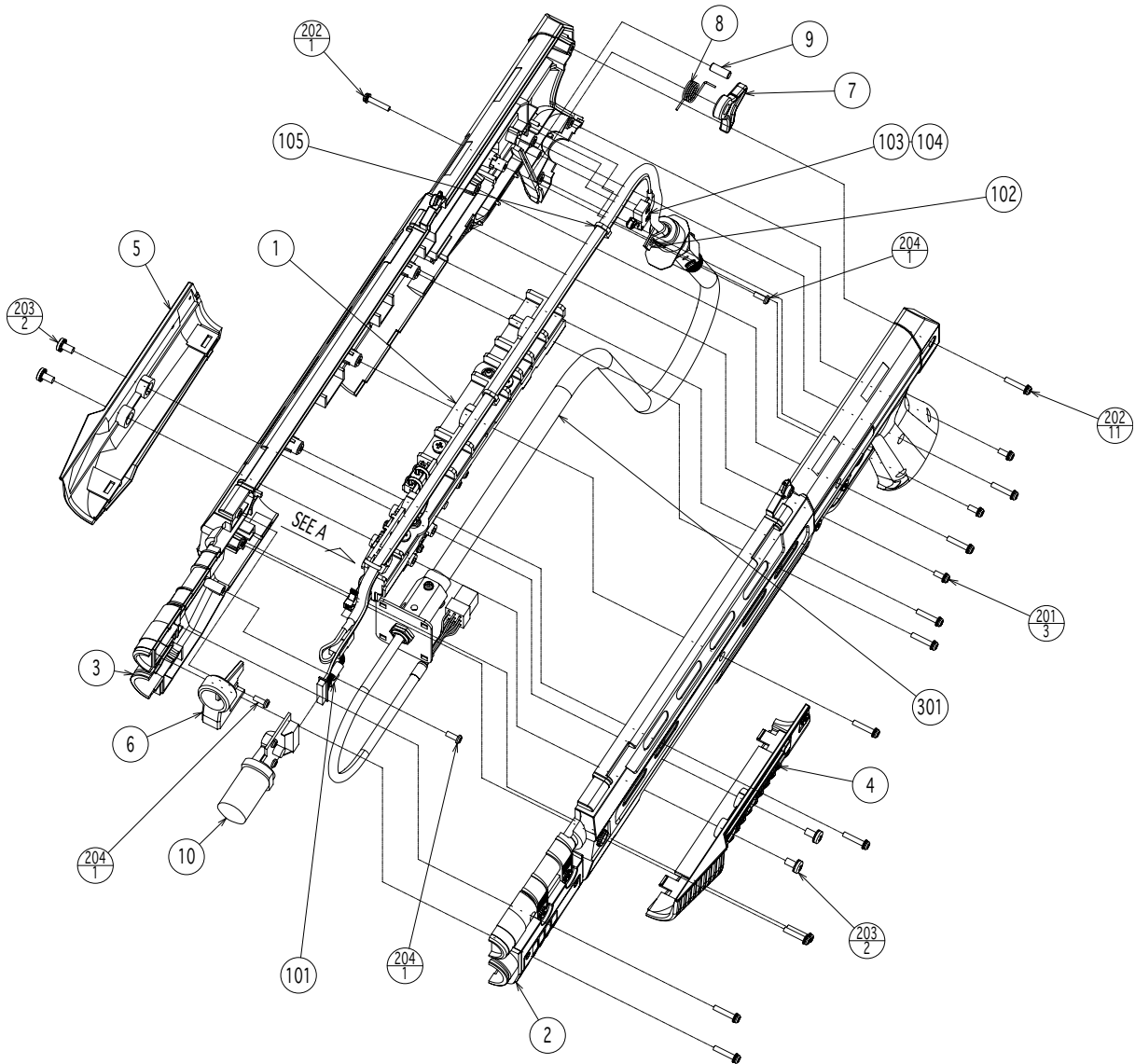

Secure the wires with the tie belt (105) in the specified part of (1).

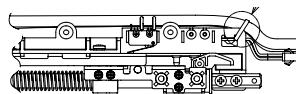

SEE A

① CONTROL UNIT (HDT-2100)

D-2/2

ITEM NO.	PART NO.	DESCRIPTION	NOTE
1	HDT-2120	ASSY SLIDE MECHA	
2	HDT-2101	COVER L	
3	HDT-2102	COVER R	
4	HDT-2103	SLIDE GRIP L	
5	HDT-2104	SLIDE GRIP R	
6	HDT-2105	FRONT SIGHT	
7	HDT-2106	TRIGGER	
8	HDT-2107	TRIGGER SPRING	
9	HDT-2108	STOPPER PIN	
10	JPT-2030	SENSOR UNIT	
101	280-5124-02	NYLON CLAMP NK02	
102	280-5124-03	NYLON CLAMP NK03	
103	310-5029-D20	SUMITUBE F D 20MM	
104	509-5080	SW MICRO TYPE (SS-5GL2)	
105	601-0460	PLASTIC TIE BELT 100 MM	
201	FAS-000092	M SCR PH W/SMALL FS BLK M3×8	
202	FAS-000093	M SCR PH W/SMALL FS BLK M3×16	
203	FAS-000094	M SCR BIND H W/TOOTH BLK M4×8	
204	FAS-120023	TAP SCR P-TITE PH 3×8	
301	999-1616	WH CONTROL UNIT	

② GAME BOARD AREA

D-1

ITEM NO.	PART NO.	DESCRIPTION	NOTE
1	843-0001D-11	GAME BOARD ASSY CHIHIRO HOD 3	
2	XKT-0833	GD-ROM DRIVE	
3	400-5443	SWITCHING POWER SUPPLY	
4	837-13551-92	I/O CONTROL BOARD FOR JVS	

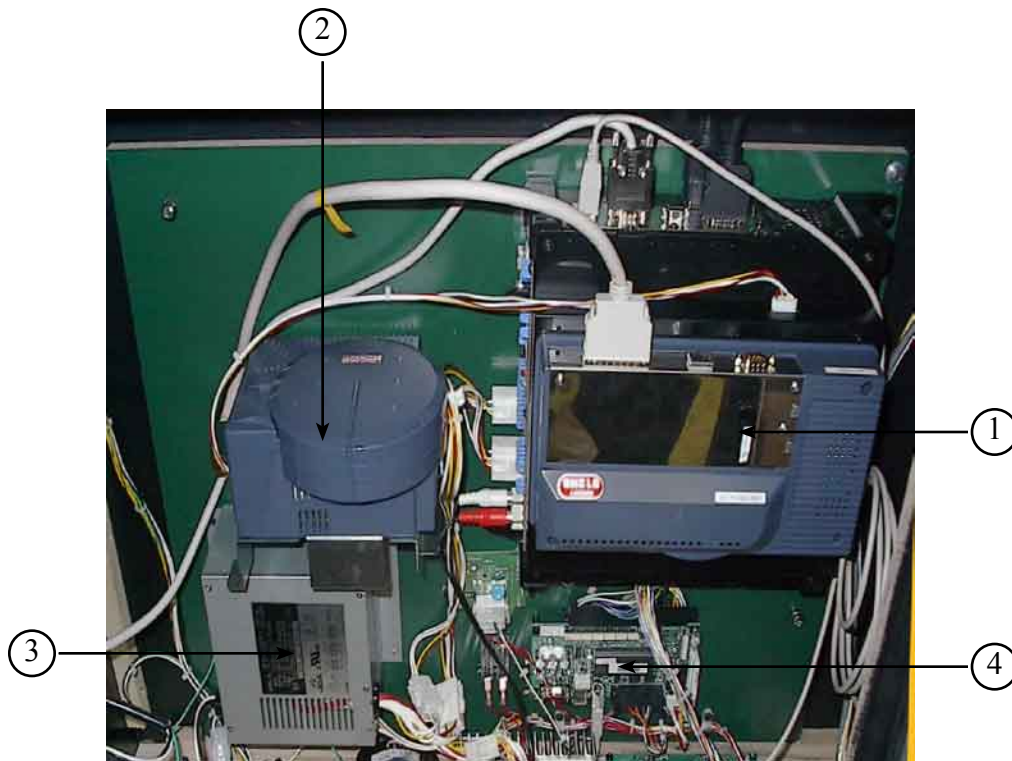

② GAME BOARD AREA

D-2

ITEM NO.	PART NO.	DESCRIPTION	NOTE
1	998-0165	GUN INPUT PROTECTION CIRCUIT	
2	838-13143-08	IC BD GUN SENSE SPY	
3	560-5407-UL	TRANSFORMER AUDIO	
4	838-13616	AUDIO POWER AMP 2 CH	

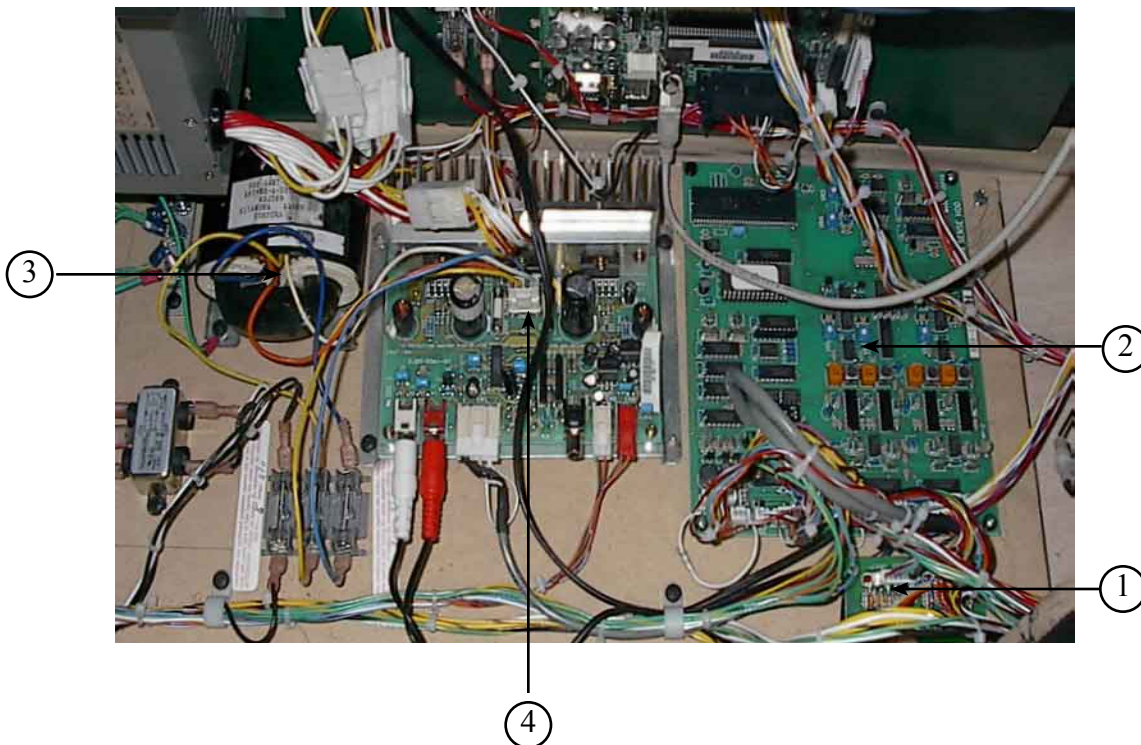

③ OTHER PARTS

D-1

ITEM NO.	PART NO.	DESCRIPTION	NOTE
1	999-1656	PUSH BUTTON 1 1/2" YELLOW START 1	
2	999-1657	PUSH BUTTON 1 1/2" YELLOW START 2	
3	999-0167	LEG LEVELER 1/2-13-3"	
4	999-0168	CASTER 160-2 1/2 #251888 SWIVEL	
5	LOCAL PURCHASE	FLUORESCENT LAMP ASSY 24" COOLWHITE	
6	999-1442	SPEAKER 4 OHM 15 WATT	
7	JPT-1082	IR COVER	
8	838-13145-02	LED BD GUN SENSE HOD	
9	999-1602	VENT AIR HOLE	
10	LOCAL PURCHASE	TEMPERED MONITOR GLASS Height - 24.781" Width - 28.828" Thickness - .188"	
11	999-1614	SPACER RUBBER (GUN HOLDER)	
12	999-1659	PLASTIC PROTECTOR LEFT	
13	999-1660	PLASTIC PROTECTOR RIGHT	
14	999-1658	RUBBER PAD	
15	999-1596	FAN 110/120VAC 17/15W SINWAN	
16	999-1655	CONTROL PANEL COVER	
17	999-1766	LEFT GUN HOLDER	
18	999-1767	RIGHT GUN HOLDER	
	999-1222	POT 5K OHM	
101	LOCAL PURCHASE	BOLTS 1/4-20 X 3 (2 PER GUN HOLDER)	
102	LOCAL PURCHASE	NUTS 1/4-20 ELASTIC STOP NUT (2 PER HUN HOLDER)	

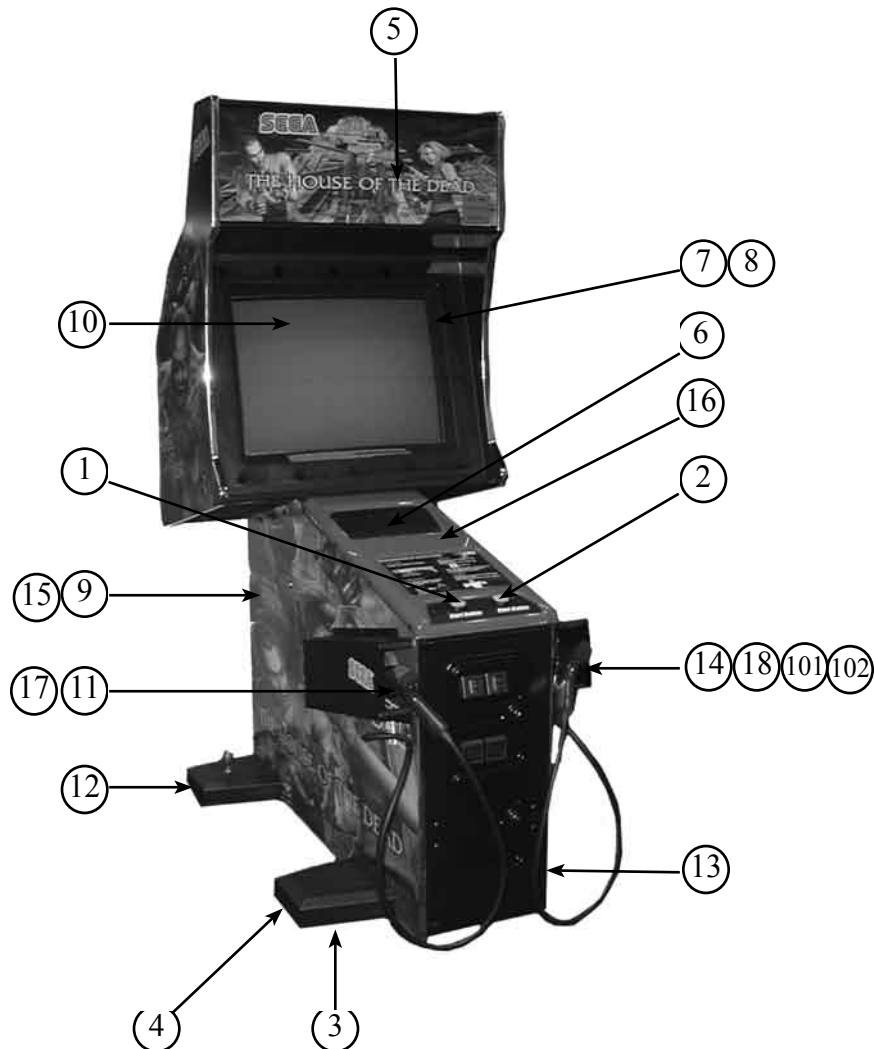

13. WIRE COLOR CODE TABLE

THE WIRE COLOR CODE is as follow:

- A PINK
- B SKY BLUE
- C BROWN
- D PURPLE
- E LIGHT GREEN

Wires other than those of any of the above 5 single colors will be displayed by 2 alphanumeric characters.

- 1 RED
- 2 BLUE
- 3 YELLOW
- 4 GREEN
- 5 WHITE
- 7 ORANGE
- 8 BLACK
- 9 GRAY

If the right-hand side numeral of the code is 0, then the wire will be of a single color shown by the left-hand side numeral (see the above).

Note 1: If the right-hand side alphanumeric is not 0, that particular wire has a spiral color code. The left-hand side character shows the base color and the right-hand side one, the spiral color.

<Example> 51 WHITE / RED

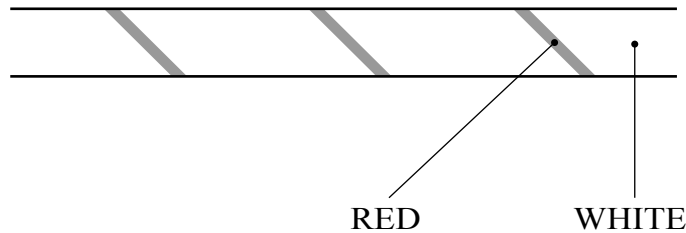

Note 2: The character following the wire color code indicates the size of the wire.

- U: AWG16
- K: AWG18
- L: AWG20
- None: AWG22

Warranty

Your new Sega Product is covered for a period of 90 days from the date of shipment. This certifies that the Printed Circuit Boards, Power Supplies and Monitor are to be free of defects in workmanship or materials under normal operating conditions. This also certifies that all Interactive Control Assemblies are to be free from defects in workmanship and materials under normal operating conditions. No other product in this machine is hereby covered.

Sellers sole liability in the event a warranted part described above fails shall be, at its option, to replace or repair the defective part during the warranty period. For Warranty claims, contact your Sega Distributor.

Should the Seller determine, by inspection that the product was caused by Accident, Misuse, Neglect, Alteration, Improper Repair, Installation or Testing, the warranty offered will be null and void.

Under no circumstances is the Seller responsible for any loss of profits, loss of use, or other damages.

This shall be the exclusive written Warranty of the original purchaser expressed in lieu of all other warranties expressed or implied. Under no circumstance shall it extend beyond the period of time listed above.



SEGA AMUSEMENTS USA, INC.

45133 Industrial Drive
Fremont, CA 94538
(415) 701-6580 phone
(415) 701-6594 fax