

MIDWAY

JANUARY 1995

16-44047-101

KILLER INSTINCT KIT

MANUAL

- includes -

installation & operation
parts information
wiring diagrams

KILLER INSTINCT

KIT

MIDWAY Manufacturing Company reserves the rights to make modifications and improvements to its products. The specifications and parts identified in this manual are subject to change without notice.

TABLE OF CONTENTS

Section 1 Operation and Troubleshooting

Safety	1-2
Conversion Procedure	1-3
Notice - FCC Warning Sticker.....	1-3
Inspection.....	1-3
Converting from a Typical Game Cabinet.....	1-4
Recommended Tools & Supplies.....	1-4
Cabinet Modifications.....	1-4
Control Panel Modifications.....	1-4
Install the PC board, Hard Drive & Fan into a JAMMA Cabinet.....	1-6
Install the PC board, Hard Drive & Fan into a NON-JAMMA Cabinet.....	1-8
Game Features	1-10
Starting-up.....	1-10
Player Controls.....	1-10
Control Panel Diagram.....	1-11
Menu System Operation	1-11
Operation.....	1-11
Main Menu.....	1-12
Diagnostic Tests.....	1-12
Switch Test.....	1-13
DIP Switch Test & Table.....	1-14
CPU Board Test.....	1-14
Sound Board Test.....	1-15
Monitor Patterns Test.....	1-16
Check Disk.....	1-16
Burn-in Test.....	1-17
Coin Bookkeeping.....	1-18
Game Audits.....	1-23
Game Adjustments.....	1-25
Standard Pricing.....	1-26
Custom Pricing.....	1-27
Utilities.....	1-28
Volume Adjust.....	1-29
Troubleshooting	

Section 2 Parts Information

CPU/Sound Board.....	2-2
Hard Drive Mounting Bracket & Complete Hard Drive Assembly Diagram.....	2-3
Fan, Fan Mounting Bracket & Complete Fan Assembly Diagram.....	2-4

Section 3 Diagrams and Schematics

JAMMA Chart.....	3-2
Interboard Wiring Diagram.....	3-3
Coin Switch and Meter Wiring.....	3-4
Cabinet Wiring Diagram.....	3-5
Electronic Rack Assembly.....	3-6
Templates.....	0-0

Killer Instinct™

©1994 Nintendo/Rare

Game by Rare

Killer Instinct is a trademark of Nintendo

Manufactured and sold by Midway Manufacturing Company under license.

KILLER INSTINCT KIT

**SECTION
one**

Operation

SAFETY NOTICES

The following safety instructions apply to all kit operators and service personnel. Specific warnings and cautions will be found throughout this manual where they apply. We recommend that you read this page before preparing your kit for play.



CAUTION

HARD DRIVE. The operator must retain the special shipping box and antistatic bag that the hard drive is packed in. The hard drive must be repacked in its original container before returning to the distributor for replacement or repair. The hard drive must be removed from the game cabinet and repacked into its original container BEFORE the game cabinet is moved to a new location. If the original shipping box and antistatic static bag is lost or destroyed, a replacement can be order from the distributor. Shipping Box #08-7936, Anti-Static Bag #20-9638-3

FAN. The fan must be connected to a fused 110V power source.

SALVAGED PARTS. Parts salvaged from old games are required to complete your kit. These salvaged parts must operate perfectly: otherwise, the converted game cannot perform properly or safely. Always repair circuit board malfunctions and cabinet damage before conversion is attempted.

POWER SUPPLY. Be sure the power supply from your old game is capable of +5VDC at 5A, -5VDC at 1A and +12V at 2A. These operating voltages are necessary for the kit. Your power supply must be FCC approved.

MONITOR. This kit is not intended for use with X-Y monitors. Suitable monitors have horizontally mounted CRTs and raster electronics with inputs for red, green and blue video, as well as COMPOSITE NEGATIVE SYNC inputs.

COIN MECHANISM. Be sure to clean and lubricate your old coin mechanisms. Servicing them is crucial to your game's earning potential and operation.

COIN METERS. Coin meters are not provided with this kit. Wiring information is provided as a convenience to the operator.

DISCONNECT POWER DURING INSTALLATION OR REPAIRS. To avoid electrical shock, disconnect the game from the AC power source before attempting to service or install your kit.



ATTENTION !

PROPERLY ATTACH ALL CONNECTORS. Be sure that the connectors on each printed circuit board (PCB) are properly connected. If they do not slip on easily, do not force them. A reversed connector may damage your game and void the warranty. All connectors are keyed to fit specific pins on each board.

NOTICE - FCC WARNING STICKER

- I. **THIS KIT WAS TESTED IN A MIDWAY UNIVERSAL VIDEO CABINET AND FOUND TO COMPLY WITH FCC PART 15 CLASS A REQUIREMENTS. IF INSTALLED IN MIDWAY UNIVERSAL VIDEO CABINET, THE FCC WARNING STICKER (16-9306) SUPPLIED IS TO BE PLACED ON THE REAR OF THE CABINET.**
- II. **INSTALLATION OF THIS KIT INTO ANY OTHER PRODUCT DOES NOT GUARANTY COMPLIANCE WITH FCC REQUIREMENTS. YOU ARE SOLELY RESPONSIBLE, AND MIDWAY WILL HAVE NO RESPONSIBILITY, FOR FCC COMPLIANCE FOR INSTALLATIONS IN OTHER PRODUCTS. THE FCC WARNING STICKER SUPPLIED SHOULD NOT BE INSTALLED ON THE CONVERTED PRODUCT UNTIL FCC COMPLIANCE IS VERIFIED.**

CONVERSION PROCEDURE

INSPECTION

Unpack the materials from the carton and inspect for obvious signs of damage. Use this checklist to be sure the kit is complete.

	Part Number	Item	Quantity
[]	A-19595.1	hard drive mounting bracket	1
[]	A-19596	programmed hard drive	1
[]	A-19650-40047	CPU/Sound board assembly	1
[]	A-19806	fan mounting bracket	2
[]	H-19960	main JAMMA cable	1
[]	H-19961	auxiliary (control panel) cable	1
[]	03-8338-1	1/4" PCB mounting spacers	7
[]	03-9223	fan guard - plastic	1
[]	08-7936	hard drive shipping box	1
[]	16-9306	FCC Warning Sticker	1
[]	16-9922	Epilepsy Warning Label	1
[]	20-9420	fan grille - metal	1
[]	20-9620	key T-20 TR-TX long arm	1
[]	20-9638-3	hard drive anti-static bag	1
[]	20-9687-3	blue pushbuttons	12
[]	20-9687-2	white pushbuttons	2
[]	20-9947	fan	1
[]	20-10178-3	8-way joysticks	2
[]	20-10180	fan AC cable	1
[]	20-10188	truss head phillips screws	4 (to attach hard drive to mounting bracket)
[]	31-1789	clear overlay	1
[]	31-2020-1	screened marquee	1
[]	31-2229	side panel decal	2
[]	31-2311	screened overlay	1
[]	31-2312	decal set	1
[]	4006-01192-34	6-32x2-1/8 machine screws	4 (to attach grille, guard & fan to mtg brkt)
[]	4108-01092-10B	torx head sheet metal screws	10 (to attach clear overlay to control panel)
[]	4308-01123-24B	8-32x1-1/2 bolts	8 (to attach joysticks to control panel)
[]	4408-01128-00	8-32 nuts	8 (to attach joysticks to control panel)
[]	4700-00090-00B	flat washers .156x.375x.030	10 (to attach clear overlay to control panel)
[]	5556-13956-00	ferrite bead 2 piece 1-1/4"	1
[]	5556-14510-00	ferrite bead flat cable type	2
[]	5795-14459-00	ribbon cable 2-1/8"	1
[]		FBI Label	1

Always install PC boards and hard drive as shown in Electronic Rack Assembly drawing, (page 3-6).

CONVERTING FROM A TYPICAL VIDEO GAME CABINET

Recommended tools and supplies

- | | |
|--|--|
| <input type="checkbox"/> black semi-gloss paint | <input type="checkbox"/> black electrical tape |
| <input type="checkbox"/> electric drill | <input type="checkbox"/> surplus assorted screws |
| <input type="checkbox"/> electric screwdriver | <input type="checkbox"/> wire cutters |
| <input type="checkbox"/> grease pencil or marker | <input type="checkbox"/> soldering iron and solder |
| <input type="checkbox"/> hex driver | <input type="checkbox"/> razor knife |
| <input type="checkbox"/> 180 grit sandpaper or electric sander | |

CABINET MODIFICATIONS

1. Repaint the cabinet with black semi-gloss paint (games with wood grain sides: remove the old decal and artwork and clean the glue residue before painting). Allow paint to dry.
2. Pencil a line roughly at the top of the old graphic. Lightly moisten the cabinet with soapy water. Apply the decal starting at the top and working down. After the decal is in place, smooth it down, taking care to squeeze out air bubbles. If you miss an air bubble, pop it with a razor knife or a pin and burnish it down. Allow 12 hours for the adhesive in the decal to set. Remove the masking.
3. Remove the marquee from the game cabinet and install the **KILLER INSTINCT** marquee in its place.
4. Place Epilepsy Warning Label on the front of the monitor bezel. Be sure that it does not obstruct the CRT screen, but is in full view of the players.

CONTROL PANEL MODIFICATIONS

1. Remove the control panel buttons and joysticks and remove the old vinyl covering and artwork.
2. Use the control panel templates to help you design the control panel. (Templates are the last pages of this manual) Refer to page 1-5 for suggested template layout.
3. Drill holes, as needed, for the joysticks and control panel buttons. Plug previous holes with wood blocks, putty, cardboard or epoxy. File the new holes smooth.
4. Carefully remove the backing on the vinyl control panel overlay. Place the overlay on the top of the control panel. Prevent air bubbles from getting under the overlay.
5. After the overlay is on securely, use a razor knife to cut holes for the control panel buttons and joysticks.
6. Position the stickers next to the appropriate hole locations. Refer to page 1-5 for suggested control panel button and joystick sticker locations.
7. Being careful not to displace the stickers, place the overlay on the control panel. Use the torx head sheet metal screws and flat washers to attach the clear overlay to the control panel. Once the clear overlay is securely in place, cut holes for the joysticks and control panel buttons.

8. Remove the switch from the pushbutton by pulling the large prong away from the switch, then pull the switch off of the housing. Unscrew the nut from the housing. Open the control panel. Push the switch through the front of the panel and screw the nut onto the switch housing from the back of the panel. Snap the switch back onto the housing.
9. To install the joysticks, first remove the "E"-ring and slide the shaft and the plastic ring off the joystick base. Be sure that the bushings remain in the base. Use the 8-32 bolts and the 8-32 nuts to attach the base to the underside of the control panel. Slide the plastic ring around the shaft so that the rough side is next to the shaft handle. Slide the shaft through the control panel and base. Replace the "E"-ring.

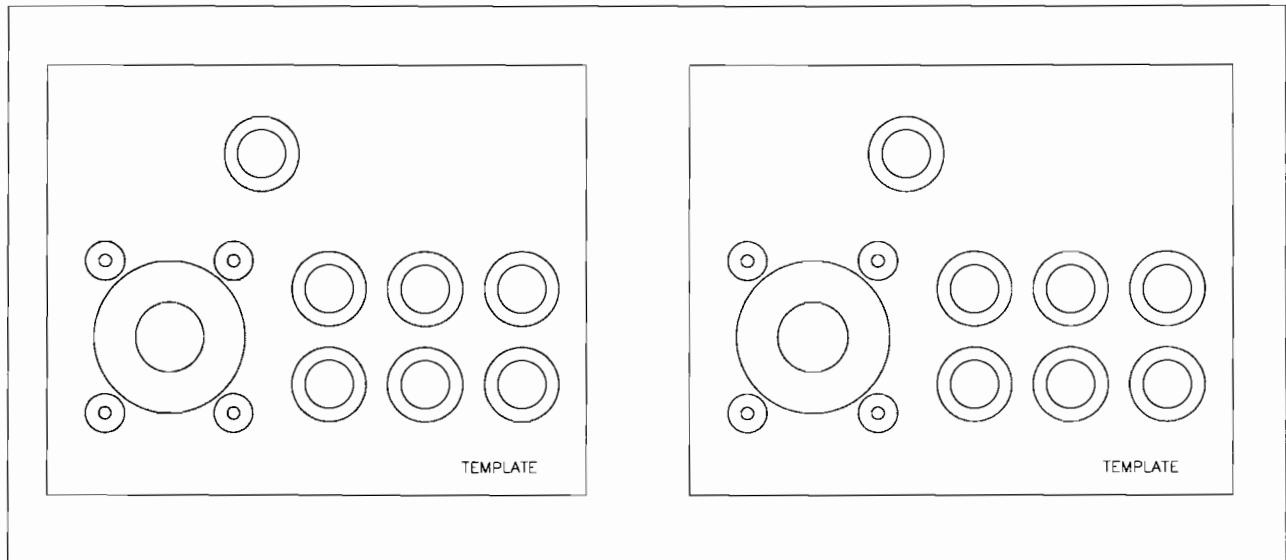

SUGGESTED CONTROL PANEL TEMPLATE LAYOUT
(Templates are the last pages of this manual)

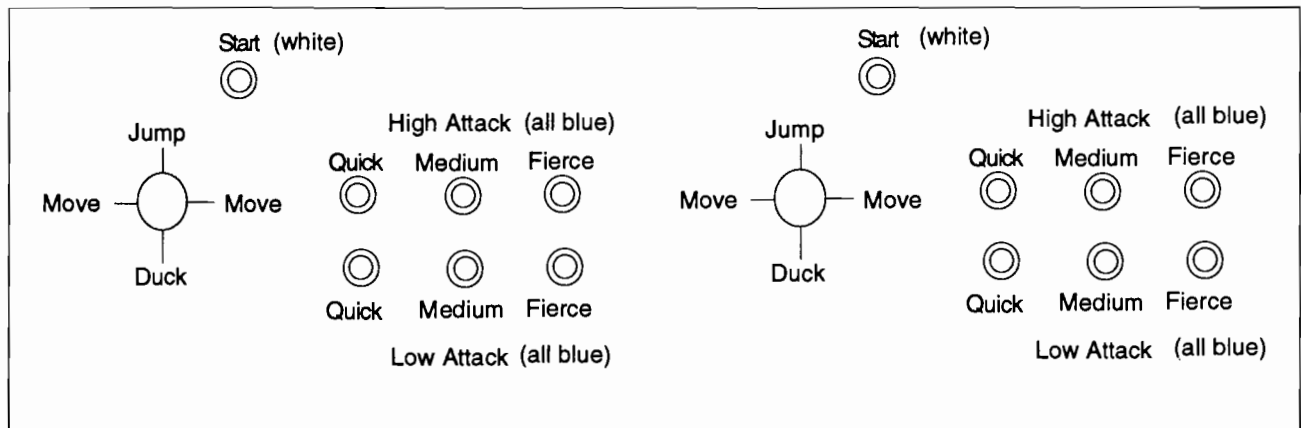

SUGGESTED CONTROL PANEL LAYOUT AND STICKER LOCATIONS FOR A TYPICAL VIDEO GAME CONTROL PANEL.

INSTALL THE PC BOARD, HARD DRIVE & FAN INTO A JAMMA GAME CABINET

PC board, fan, and hard drive must be installed as shown in *Electronic Rack Assembly drawing, (page 3-6)*.

1. Replace the existing CPU board and sound board with the **KILLER INSTINCT** CPU/Sound board. Use the 1/4" PCB mounting spacers and surplus screws to secure the CPU/Sound board to the rack.

2. Install the hard drive using: A-19595.1 hard drive mounting bracket, A-19596 programmed hard drive, 20-10188 truss head phillips screws, 5556-14510-00 ferrite bead, 5795-14459-02 ribbon cable.

Screw the four truss head screws part way into the threaded holes on the sides of the hard drive. With the L-slots on the mounting bracket facing down, and the connector on the hard drive facing up, slide the hard drive back and down, into the slots on the bracket. Tighten the truss head screws.

Remove one clip from the ferrite bead and slide the bead over the ribbon cable. Replace the clip. Plug the ribbon cable into the connector on the hard drive. With the ribbon cable facing the CPU/Sound board, attach the hard drive mounting bracket, to the rack with surplus screws. Be sure the ribbon cable can reach J6 on the CPU/Sound board. See page 2-3 for diagram.

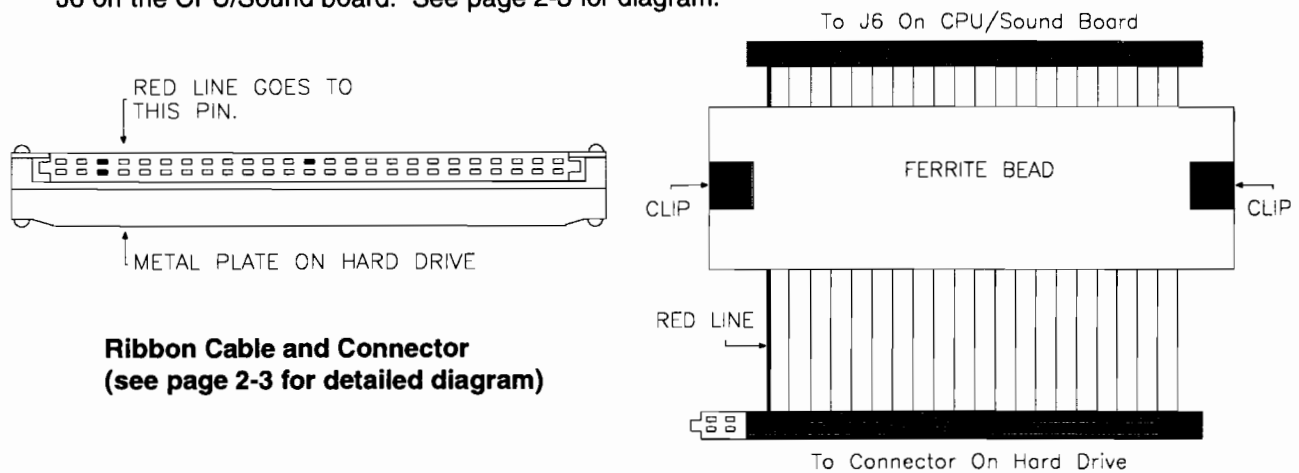

Ribbon Cable and Connector
(see page 2-3 for detailed diagram)

3. Install the fan using: A-19806 fan mounting brackets, 03-9223 fan guard, 20-9420 fan grille, 20-9947 fan, 20-10180 fan AC cable, 4006-01192-34 machine screws.

Place the grille on the front of the fan, and the guard on the back of the fan. Place the long end of the mounting bracket (one for the left side and one for the right) behind the guard. Line up the screw holes. Secure together with the machine screws.

Be sure that the fan is aligned so that air flows toward the CPU/Sound board and attach the assembly to the rack using surplus screws. Plug fan AC cable into the fan and attach the other end to a fused 110V source. The fan must be powered up anytime the CPU/Sound board is running. See page 2-4 for diagram.

4. If you choose to use the JAMMA cable provided with the kit, disconnect your old JAMMA cable from the speaker, power supply, control panel switches (may already be disconnected) and coin door. Remove the cable from the game. Leave your power supply chassis as is. **NOTE: If you choose to use your own JAMMA cable, check the JAMMA chart to be sure your cable is compatible.**

CAUTION

Properly insulate any unused wires, within the JAMMA cable, especially the gray, gray-green and gray-yellow wires. This is a fully wired JAMMA cable. Many of the wires will not be used for this kit. These wires have been installed so that you can use this cable for future kits.

5. Connect the JAMMA cable to the CPU/Sound board. Use the Cabinet Wiring Diagram for reference and solder the correct JAMMA cable wires to the speaker. Then, connect the wires to the coin door, power supply and the control panel. Player 1 has white-'color stripe' wires, except for the Start 1 which has a solid white wire. Player 2 has violet-'color stripe' wires. Use the Cabinet Wiring Diagram in section 3, or the control panel wire color list on the inside back cover for reference when connecting these wires to the player 1 and 2 control panel switches.
6. Attach ferrite bead (5556-13956-00) to JAMMA cable. See Electronic Rack Assembly drawing on page 3-6 for correct bead placement.
7. Connect the Auxiliary cable to J7 of the CPU/Sound board. Use the Cabinet Wiring Diagram in section 3, or the control panel wire color list on the inside back cover for reference when connecting these wires to the Low/Quick, Low/Medium, and Low/Fierce switches.
8. Place the FBI Warning Label next to the CPU/Sound board. Be sure the label is completely visible.

INSTALL THE PC BOARD, HARD DRIVE & FAN INTO A NON-JAMMA GAME CABINET

PC board, fan, and hard drive must be installed as shown in Electronic Rack Assembly drawing, (page 3-6).

1. Replace the existing CPU board and sound board with the **KILLER INSTINCT** CPU/Sound board. Use the 1/4" PCB mounting spacers and surplus screws to secure the CPU/Sound board to the rack.
2. Install the hard drive using: A-19595.1 hard drive mounting bracket, A-19596 programmed hard drive, 20-10188 truss head phillips screws, 5556-14510-00 ferrite bead, 5795-14459-02 ribbon cable.
Screw the four truss head screws part way into the threaded holes on the sides of the hard drive. With the L-slots on the mounting bracket facing down, and the connector on the hard drive facing up, slide the hard drive back and down, into the slots on the bracket. Tighten the truss head screws.
Remove one clip from the ferrite bead and slide the bead over the ribbon cable. Replace the clip. Plug the ribbon cable into the connector on the hard drive. With the ribbon cable facing the CPU/Sound board, attach the hard drive mounting bracket, to the rack with surplus screws. Be sure the ribbon cable can reach J6 on the CPU/Sound board. See page 2-3 for diagram.

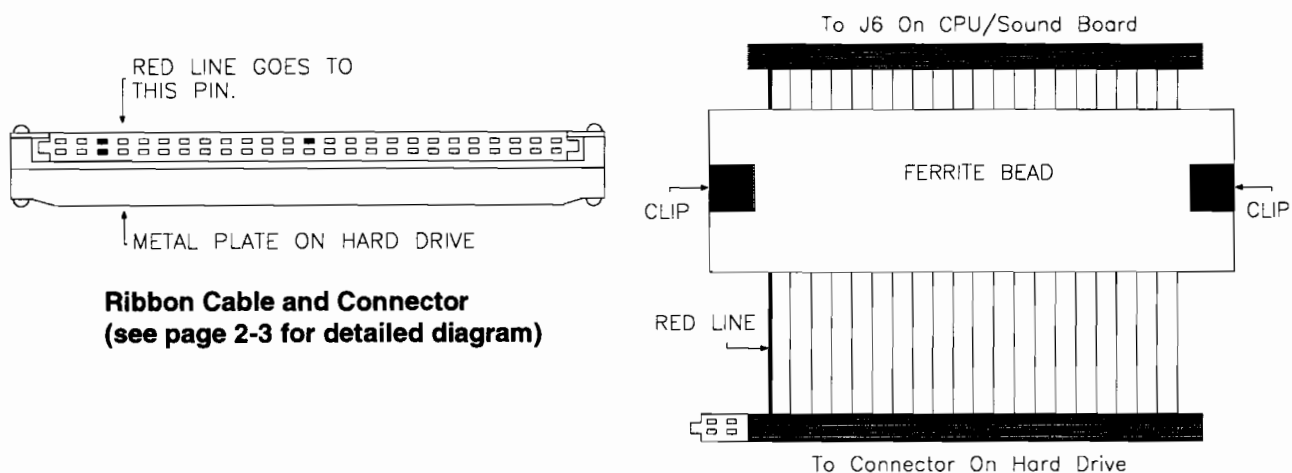

3. Install the fan using: A-19806 fan mounting brackets, 03-9223 fan guard, 20-9420 fan grille, 20-9947 fan, 20-10180 fan AC cable, 4006-01192-34 machine screws.
Place the grille on the front of the fan, and the guard on the back of the fan. Place the long end of the mounting bracket (one for the left side and one for the right) behind the guard. Line up the screw holes. Secure together with the machine screws.
Be sure that the fan is aligned so that air flows toward the CPU/Sound board and attach the assembly to the rack using surplus screws. Plug fan AC cable into the fan and attach the other end to a fused 110V source. The fan must be powered up anytime the CPU/Sound board is running. See page 2-4 for diagram.
4. Leaving several inches of wire, cut the wires at the coin door, control panel switches, (which may already be disconnected) speaker and power supply. Remove the harness from the cabinet. Leave your power supply chassis as is. **NOTE: Be sure that all spliced wires are well insulated with black electrical tape.**
5. Install the JAMMA cable provided with the kit. Players 1 and 2, the coin door, and the power supply wires are bundled together in individual groups. Insure that the cable is properly dressed and supported.

CAUTION

Properly insulate any unused wires, within the JAMMA cable, especially the gray, gray-green and gray-yellow wires. This is a fully wired JAMMA cable. Many of the wires will not be used for this kit. These wires have been installed so that you can use this cable for future kits.

6. Connect the JAMMA cable to the CPU/Sound board. Use the Cabinet Wiring Diagram for reference and solder the correct JAMMA cable wires to the speaker. Then, connect the wires to the coin door, power supply and the control panel. Player 1 has white-'color stripe' wires, except for the Start 1 which has a solid white wire. Player 2 has violet-'color stripe' wires. Use the Cabinet Wiring Diagram in section 3, or the control panel wire color list on the inside back cover for reference when connecting these wires to the player 1 and 2 control panel switches.
7. Attach ferrite bead (5556-13956-00) to JAMMA cable. See Electronic Rack Assembly drawing on page 3-6 for correct bead placement.
8. Connect the Auxiliary cable to J7 of the CPU/Sound board. Use the Cabinet Wiring Diagram in section 3, or the control panel wire color list on the inside back cover for reference when connecting these wires to the Low/Quick, Low/Medium, and Low/Fierce switches.
9. Place the FBI Warning Label next to the CPU/Sound board. Be sure the label is completely visible.

GAME FEATURES

STARTING UP

Switch on power to the game. The game runs through a start-up routine.

Insert the desired amount of coins, bills or tokens. Select which player receives the credit by pressing the appropriate Start button.

NOTE

When an error is detected during the Start-up tests, game start-up does not progress, and an error message appears on the screen.

PLAYER CONTROLS

Start Button

Each player has a Start button. The Start buttons allow one or two players to begin or continue play.

Joysticks

Each player has a joystick which he uses to control an on-screen character. The player can make the on-screen character move, jump or duck.

High Attack

An attack that originates above the waist, such as a punch.

Low Attack

An attack that originates below the waist, such as a kick.

Quick

A "quick" attack is a short range, short duration attack that inflicts little damage to an opponent.

Medium

A "medium" attack is a moderate range, moderate duration attack that inflicts some damage to an opponent.

Fierce

A "fierce" attack is a long range, long duration attack that inflicts much damage to an opponent.

NOTE

Use joystick and button combinations to discover secret moves.

CONTROL PANEL DIAGRAM

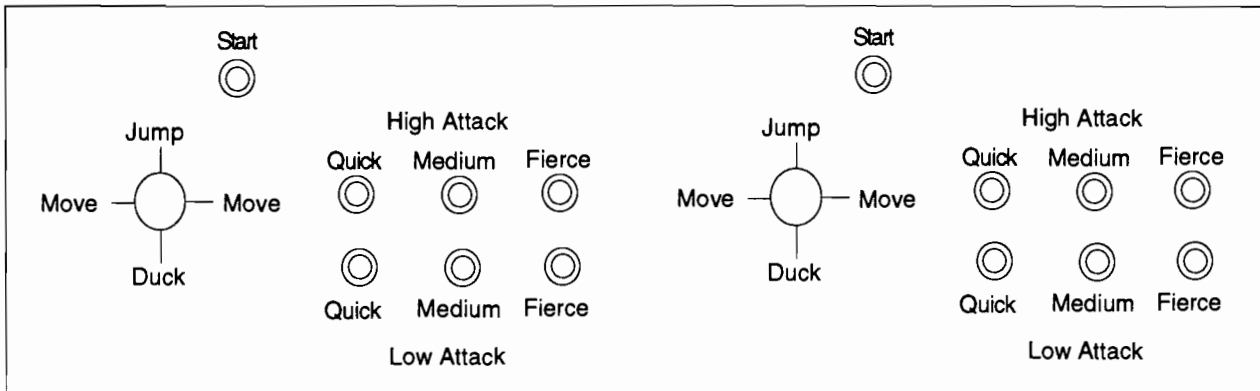

MENU SYSTEM OPERATION

OPERATION

All game audits, adjustments and diagnostics are options of the Main Menu. Each option, in turn, has its own menu that lists several choices which you may act upon as desired.

Close switch #8 of DIP switch bank #2 to open the Main Menu (shown below). Game adjustments, bookkeeping and diagnostics are all accessible from this menu.

Use either joystick to move the cursor up and down the menu screen. Notice that the options are highlighted in sequence. Press any button to open a highlighted option. *Only highlighted options can be opened.*

To exit the Main Menu, use either joystick to select EXIT TO GAME OVER and press any button.

KILLER INSTINCT
VERSION X.X

DIAGNOSTIC TEST
COIN BOOKKEEPING
GAME AUDITS
GAME ADJUSTMENTS
UTILITIES
VOLUME ADJUST
EXIT TEST MENU

MAIN MENU

DIAGNOSTIC TESTS

Use either joystick to select the Diagnostic Menu and any button to open it. Then, use either joystick to move the cursor up and down the menu and any button to open a highlighted option.

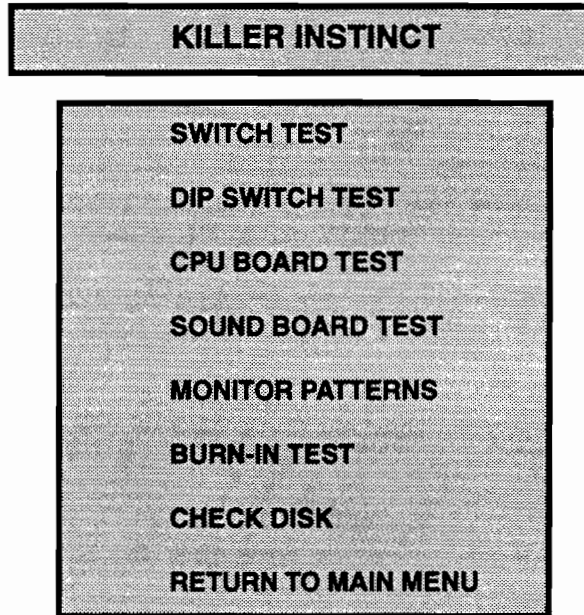

DIAGNOSTIC MENU

Switch Test

The Switch Test allows the operator to test the switches on the control panel and in the coin door.

Use either joystick to highlight the Switch Test and any button to begin the test.

During the Switch Test the top of the screen shows the control panel switches while the bottom of the screen shows the coin door switches. Press a control panel or coin door switch and the switch location on the screen lights. Release the switch and the screen returns to normal.

To exit the Switch Test, press both Start buttons together.

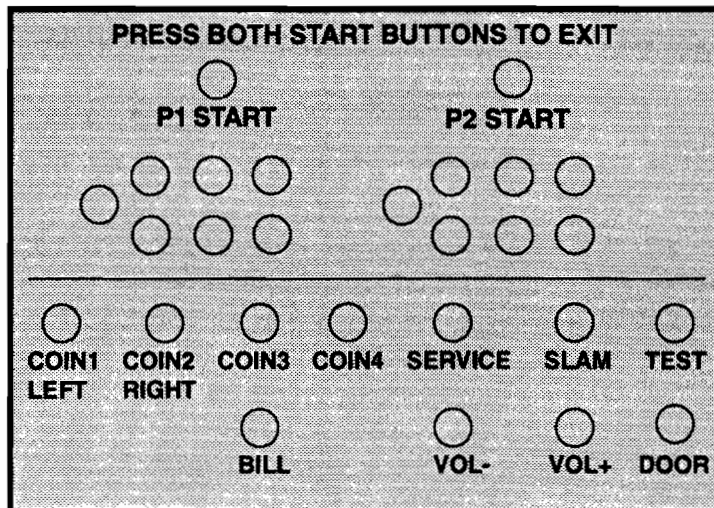

SWITCH TEST SCREEN

DIP Switch Test

The DIP Switch Test allows the operator to check or change the position of the DIP Switches on the CPU Board.

Use either joystick to select the DIP Switch Test and press any button to access the DIP Switch Setting Tables. The screen displays the current DIP Switch settings. To change a setting, slide the switch to the desired position, then check the screen to verify the new setting. *In some cases, setting a function to OFF actually enables the function. For example, setting DIP Switch Coinage to Off enables DIP Switch Coinage.*

Press any button to return to the Diagnostic Menu.

DIP Switch 1 Setting Table

	SW1	SW2	SW3	SW4	SW5	SW6	SW7	SW8
High Blood Level	Off*	Off*						
Med. Blood Level	On	Off						
Low Blood Level	Off	On						
No Blood	On	On						
Attract Sounds			Off*					
No Attract Sounds			On					
Ending Moves				Off*				
No Ending Moves				On				
Display Violence Warning					Off*			
No Violence Warning					On			
Not Used						Off*	Off*	Off*
						On	On	On

DIP Switch 2 Setting Table

	SW1	SW2	SW3	SW4	SW5	SW6	SW7	SW8
DIP Sw. Coinage	Off*							
Disk Coinage	On							
Coin Settings								
USA1 Ger1 Fr1		Off*	Off*	Off*				
USA2 Ger2 Fr2		On	Off	Off				
USA3 Ger3 Fr3		Off	On	Off				
USA4 Ger4 Fr4		On	On	Off				
USAECA GerECA FrECA		Off	Off	On				
USA9		On	Off	On				
USA10		Off	On	On				
Free Play Free Play Free Play		On	On	On				
Country								
USA					Off*	Off*		
Germany					On	Off		
France					Off	On		
Not Used					On	On		
One Counter							Off*	
Two Counters							On	
Game Mode								Off*
Test Mode								On

* Indicates Factory Setting.

CPU Board Test

Select the CPU Board Test with either joystick then press any button to start the automatic test. When this test is activated, a "rug" pattern appears on the screen. When the rug pattern ends, *Test O.K.* or *Test Failed* appears on the screen. This test returns to the Diagnostic Menu automatically.

Sound Board Test

This test allows the operator to listen to some of the sounds this game is capable of producing.

Use either joystick to select the test, then press any button to open the test menu. The screen displays two test options. Use either joystick to select an option and press any button to begin the test.

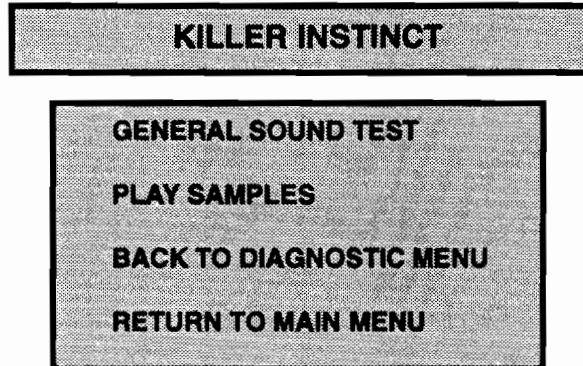

SOUND TEST MENU

GENERAL TEST analyzes the sound circuitry. The screen shows a list of error codes. A successful test causes a single "tone" to sound. Detection of a fault causes a series of tones or no tone at all to sound. Press any button to return to the Sound Test Menu.

0 TONES	-	CHECK HARDWARE
1 TONE	-	ALL O.K.
2 TONES	-	BAD U10 CHECKSUM
3 TONES	-	BAD U11 CHECKSUM
4 TONES	-	BAD U12 CHECKSUM
5 TONES	-	BAD U13 CHECKSUM
6 TONES	-	BAD U33 CHECKSUM
7 TONES	-	BAD U34 CHECKSUM
8 TONES	-	BAD U35 CHECKSUM
9 TONES	-	BAD U36 CHECKSUM
10 TONES	-	RAM TEST FAILED

PLAY SOUNDS test synthesized and digitized sounds from the CPU/Sound Board. Advance to the next sound with any button. Use either joystick to end the test.

Select **RETURN TO MAIN MENU** or **BACK TO DIAGNOSTIC MENU** and press any button.

Monitor Patterns

The Monitor Patterns Test provides a menu for testing the monitor.

Select the test with either joystick. Press any button to open the test menu. Once the Monitor Patterns Test menu is open, use either joystick to select an option, and any button to begin it.

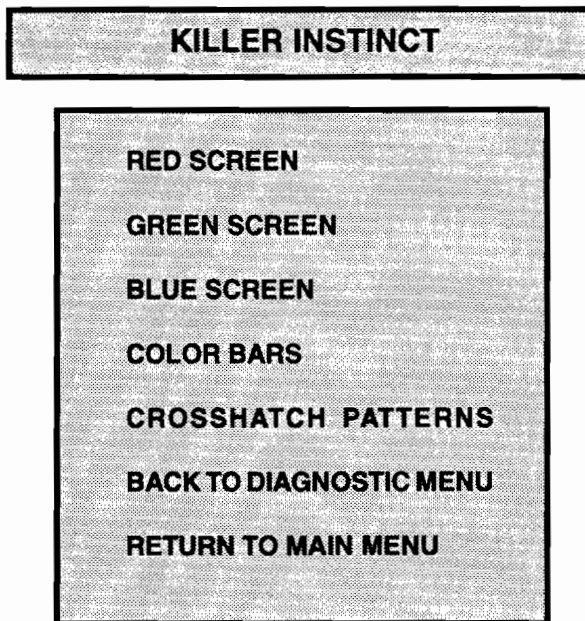

MONITOR PATTERNS MENU

The **RED**, **GREEN** and **BLUE SCREEN** tests fill the screen with either red, green or blue. Press any button to return to the Monitor Patterns Menu.

The **COLOR BARS** test fills the screen with several shades of colors to help with red, green and blue level adjustments. Each color should appear sharp and clear. Press any button to return to the Monitor Patterns Menu.

The **CROSSHATCH PATTERNS** test fills the screen with a grid and a series of dots. The grid and the dots should be clear. The dots should be round. Press any button to return to the Monitor Patterns Menu.

If any of the Monitor Patterns Test shows a need for adjustment, use the proper knobs on the Monitor Controls Board.

Use either joystick to select **RETURN TO MAIN MENU** or **BACK TO DIAGNOSTIC MENU**, then press any button.

Check Disk

This test checks the hard disk drive.

Use either joystick to select the test, then press any button to activate it. Press any button to return to the Diagnostic Menu.

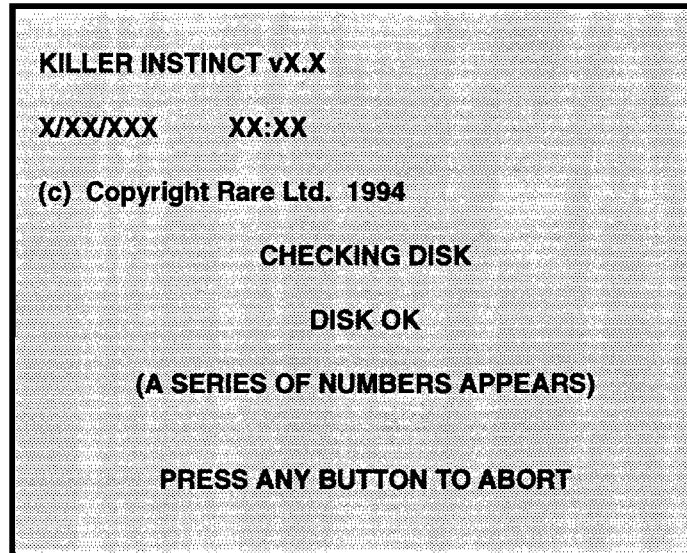

CHECK DISK SCREEN

Burn-in Test

The Burn-in Test continually repeats the CPU Board Test. Use this test to find intermittent CPU Board problems.

Use either joystick to select the test, then press any button to activate it. When the Burn-in Test detects an error the test stops and an error message is displayed on the screen. To exit this test, switch the game off, then on again.

The Audit Table specifies the number of Burn-in cycles that have been successfully completed.

COIN BOOKKEEPING

The Coin Bookkeeping Table records the coin box totals and the game play counters.

Use either joystick to select the Coin Bookkeeping Menu, then press any button to open it.

To exit Coin Bookkeeping, use either joystick to select RETURN TO MAIN MENU and press any button.

KILLER INSTINCT	
LEFT SLOT COINS	0
RIGHT SLOT COINS	0
3RD SLOT COINS	0
4TH SLOT COINS	0
BILLS	0
SERVICE CREDITS	0
BONUS CREDITS	0
PAID CREDITS	0
TOTAL CREDITS	0
RETURN TO MAIN MENU	

COIN BOOKKEEPING MENU

GAME AUDITS

Use joystick to select the Game Audits Menu, then press any button to open it. Page through the available audits by selecting NEXT AUDIT PAGE or LAST AUDIT PAGE. Select RETURN TO MAIN MENU and press any button to exit Game Audits.

NOTE

Game audits cannot be set. They can only be cleared.

KILLER INSTINCT	
1 PLAYER GAMES	0
2 PLAYER GAMES	0
FREE PLAY GAMES	0
TOTAL GAMES	0
1 PLAYER CONTINUES	0
2 PLAYER CONTINUES	0
TOTAL GAME TIME	0:0:00
TOTAL TIME ON	0:0:00
AVERAGE 1P GAME TIME	0 (SECS)
AVERAGE 2P GAME TIME	0 (SECS)
NUMBER GAME INTERRUPTS	0
COMPLETED GAMES	0
NO. SUCCESSFUL BURN-IN LOOPS	0

NEXT AUDIT PAGE
RETURN TO MAIN MENU

AUDIT MENU - PAGE ONE

GENERAL STATS					
	1P	WINS	2P	WINS	TOTAL
COMBO	0	0%	0	0%	0
JAGO	0	0%	0	0%	0
THUNDER	0	0%	0	0%	0
GLACIUS	0	0%	0	0%	0
ORCHID	0	0%	0	0%	0
CINDER	0	0%	0	0%	0
SABREWOLF	0	0%	0	0%	0
RIPTOR	0	0%	0	0%	0
FULGORE	0	0%	0	0%	0
SPINAL	0	0%	0	0%	0
EYEDOL	0	0%	0	0%	0

NEXT AUDIT PAGE
LAST AUDIT PAGE
RETURN TO MAIN MENU

AUDIT MENU - PAGE TWO

COMBO STATS				
OPPONENT	1P		2P	
	GAMES	WINS	GAMES	WINS
COMBO	0	0%	0	0%
JAGO	0	0%	0	0%
THUNDER	0	0%	0	0%
GLACIUS	0	0%	0	0%
ORCHID	0	0%	0	0%
CINDER	0	0%	0	0%
SABREWULF	0	0%	0	0%
RIPTOR	0	0%	0	0%
FULGORE	0	0%	0	0%
SPINAL	0	0%	0	0%
EYEDOL	0	0%	0	0%

NEXT AUDIT PAGE
 LAST AUDIT PAGE
 RETURN TO MAIN MENU

AUDIT MENU - PAGE THREE

JAGO STATS				
OPPONENT	1P		2P	
	GAMES	WINS	GAMES	WINS
COMBO	0	0%	0	0%
JAGO	0	0%	0	0%
THUNDER	0	0%	0	0%
GLACIUS	0	0%	0	0%
ORCHID	0	0%	0	0%
CINDER	0	0%	0	0%
SABREWULF	0	0%	0	0%
RIPTOR	0	0%	0	0%
FULGORE	0	0%	0	0%
SPINAL	0	0%	0	0%
EYEDOL	0	0%	0	0%

NEXT AUDIT PAGE
 LAST AUDIT PAGE
 RETURN TO MAIN MENU

AUDIT MENU - PAGE FOUR

THUNDER STATS				
OPPONENT	1P		2P	
	GAMES	WINS	GAMES	WINS
COMBO	0	0%	0	0%
JAGO	0	0%	0	0%
THUNDER	0	0%	0	0%
GLACIUS	0	0%	0	0%
ORCHID	0	0%	0	0%
CINDER	0	0%	0	0%
SABREWULF	0	0%	0	0%
RIPTOR	0	0%	0	0%
FULGORE	0	0%	0	0%
SPINAL	0	0%	0	0%
EYEDOL	0	0%	0	0%

NEXT AUDIT PAGE
 LAST AUDIT PAGE
 RETURN TO MAIN MENU

AUDIT MENU - PAGE FIVE

GLACIUS STATS				
OPPONENT	1P		2P	
	GAMES	WINS	GAMES	WINS
COMBO	0	0%	0	0%
JAGO	0	0%	0	0%
THUNDER	0	0%	0	0%
GLACIUS	0	0%	0	0%
ORCHID	0	0%	0	0%
CINDER	0	0%	0	0%
SABREWULF	0	0%	0	0%
RIPTOR	0	0%	0	0%
FULGORE	0	0%	0	0%
SPINAL	0	0%	0	0%
EYEDOL	0	0%	0	0%

NEXT AUDIT PAGE
 LAST AUDIT PAGE
 RETURN TO MAIN MENU

AUDIT MENU - PAGE SIX

ORCHID STATS				
OPPONENT	1P		2P	
	GAMES	WINS	GAMES	WINS
COMBO	0	0%	0	0%
JAGO	0	0%	0	0%
THUNDER	0	0%	0	0%
GLACIUS	0	0%	0	0%
ORCHID	0	0%	0	0%
CINDER	0	0%	0	0%
SABREWULF	0	0%	0	0%
RIPTOR	0	0%	0	0%
FULGORE	0	0%	0	0%
SPINAL	0	0%	0	0%
EYEDOL	0	0%	0	0%

NEXT AUDIT PAGE
 LAST AUDIT PAGE
 RETURN TO MAIN MENU

AUDIT MENU - PAGE SEVEN

CINDER STATS				
OPPONENT	1P		2P	
	GAMES	WINS	GAMES	WINS
COMBO	0	0%	0	0%
JAGO	0	0%	0	0%
THUNDER	0	0%	0	0%
GLACIUS	0	0%	0	0%
ORCHID	0	0%	0	0%
CINDER	0	0%	0	0%
SABREWULF	0	0%	0	0%
RIPTOR	0	0%	0	0%
FULGORE	0	0%	0	0%
SPINAL	0	0%	0	0%
EYEDOL	0	0%	0	0%

NEXT AUDIT PAGE
 LAST AUDIT PAGE
 RETURN TO MAIN MENU

AUDIT MENU - PAGE EIGHT

SABREWULF STATS				
OPPONENT	1P		2P	
	GAMES	WINS	GAMES	WINS
COMBO	0	0%	0	0%
JAGO	0	0%	0	0%
THUNDER	0	0%	0	0%
GLACIUS	0	0%	0	0%
ORCHID	0	0%	0	0%
CINDER	0	0%	0	0%
SABREWULF	0	0%	0	0%
RIPTOR	0	0%	0	0%
FULGORE	0	0%	0	0%
SPINAL	0	0%	0	0%
EYEDOL	0	0%	0	0%

NEXT AUDIT PAGE
 LAST AUDIT PAGE
 RETURN TO MAIN MENU

AUDIT MENU - PAGE NINE

RIPTOR STATS				
OPPONENT	1P		2P	
	GAMES	WINS	GAMES	WINS
COMBO	0	0%	0	0%
JAGO	0	0%	0	0%
THUNDER	0	0%	0	0%
GLACIUS	0	0%	0	0%
ORCHID	0	0%	0	0%
CINDER	0	0%	0	0%
SABREWULF	0	0%	0	0%
RIPTOR	0	0%	0	0%
FULGORE	0	0%	0	0%
SPINAL	0	0%	0	0%
EYEDOL	0	0%	0	0%

NEXT AUDIT PAGE
 LAST AUDIT PAGE
 RETURN TO MAIN MENU

AUDIT MENU - PAGE TEN

FULGORE STATS				
OPPONENT	1P		2P	
	GAMES	WINS	GAMES	WINS
COMBO	0	0%	0	0%
JAGO	0	0%	0	0%
THUNDER	0	0%	0	0%
GLACIUS	0	0%	0	0%
ORCHID	0	0%	0	0%
CINDER	0	0%	0	0%
SABREWULF	0	0%	0	0%
RIPTOR	0	0%	0	0%
FULGORE	0	0%	0	0%
SPINAL	0	0%	0	0%
EYEDOL	0	0%	0	0%

NEXT AUDIT PAGE
 LAST AUDIT PAGE
 RETURN TO MAIN MENU

AUDIT MENU - PAGE ELEVEN

SPINAL STATS				
OPPONENT	1P		2P	
	GAMES	WINS	GAMES	WINS
COMBO	0	0%	0	0%
JAGO	0	0%	0	0%
THUNDER	0	0%	0	0%
GLACIUS	0	0%	0	0%
ORCHID	0	0%	0	0%
CINDER	0	0%	0	0%
SABREWULF	0	0%	0	0%
RIPTOR	0	0%	0	0%
FULGORE	0	0%	0	0%
SPINAL	0	0%	0	0%
EYEDOL	0	0%	0	0%

NEXT AUDIT PAGE
LAST AUDIT PAGE
RETURN TO MAIN MENU

AUDIT MENU - PAGE TWELVE

EYEDOL STATS				
OPPONENT	1P		2P	
	GAMES	WINS	GAMES	WINS
COMBO	0	0%	0	0%
JAGO	0	0%	0	0%
THUNDER	0	0%	0	0%
GLACIUS	0	0%	0	0%
ORCHID	0	0%	0	0%
CINDER	0	0%	0	0%
SABREWULF	0	0%	0	0%
RIPTOR	0	0%	0	0%
FULGORE	0	0%	0	0%
SPINAL	0	0%	0	0%
EYEDOL	0	0%	0	0%

NEXT AUDIT PAGE
LAST AUDIT PAGE
RETURN TO MAIN MENU

AUDIT MENU - PAGE THIRTEEN

GAME ADJUSTMENTS

The Game Adjustments allow the operator to customize the game.

Use either joystick to select the Game Adjustments Menu. Press any button to open the menu.

The Game Adjustments Menu offers several options. Each option has several choices. Use either joystick to select an option, then press any button to open the option. The next menu screen provides a setting value. Use either joystick to change the setting value and press any button to lock it in.

To exit the Adjustments Menu, use either joystick to select RETURN TO MAIN MENU, then press any button.

NOTE

Adjustment values set by DIP SWITCH, override adjustment values set by the menu system.

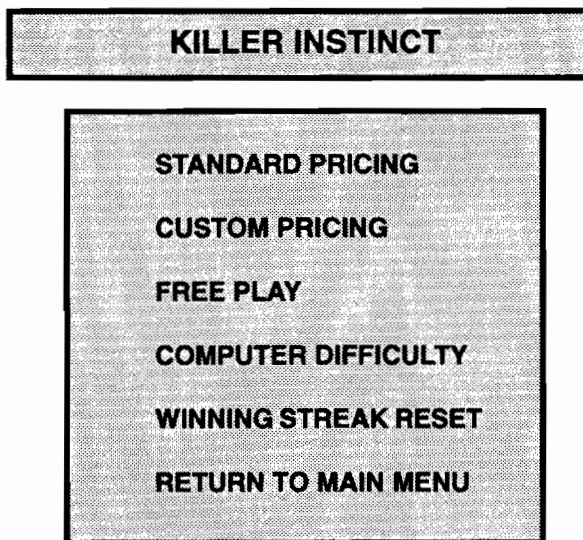

GAME ADJUSTMENTS MENU

Game Adjustments

Standard Pricing

Standard pricing allow the operator to choose any of the "standard" selections from the Standard Pricing Table. See page 1-25.

Modify the setting value with either joystick. Press any button to lock in the new value and return to the Adjustments Menu.

Custom Pricing

Custom pricing allows the operator to install pricing other than that of the Standard Pricing Table. Custom pricing also allows the operator to select the maximum amount of credits per game, the amount of credits required to start a game, and the amount of credits required to continue a game. This option is being adjusted from the DIP Switch settings. See page 1-26.

Modify the setting value with either joystick. Press any button to lock in a new value and return to the Adjustment Menu.

Game Adjustments Continued...

Free Play

This option selects free play. The setting choices for this adjustment are:

- No
- Yes
- Factory Setting: No

Computer Difficulty

This option determines how tough the computer opponents are. The setting choices for this adjustment are:

- (1) Extra Easy
- (2) Easy
- (3) Medium
- (4) Hard
- (5) Extra Hard
- Factory Setting: Medium

Winning Streak Reset

This option determines the number of games that must be played before the high scores automatically reset to factory settings. The setting choice for this adjustment are:

- No Reset
- 5000 Games
- 10,000 Games
- 15,000 Games
- Factory Setting: No Reset

STANDARD PRICING TABLE

Name	Setting - Credit/Coin	Coin 1	Coin 3	Coin 2	Coin 4	Bills
USA 1	1/25¢ (2 to Start; 2 to Continue)	25¢		25¢		\$1.00
USA 2	1/25¢ (2 to Start; 1 to Continue)	25¢		25¢		\$1.00
USA 3	1/25¢ (1 to Start; 1 to Continue)	25¢		25¢		\$1.00
USA 4	1/50¢, 3/\$1.00 (1 to Start; 1 to Continue)	25¢		25¢		\$1.00
USA 5	1/50¢, 4/\$1.00 (2 to Start; 1 to Continue)	25¢		25¢		\$1.00
USA 6	1/50¢ (1 to Start; 1 to Continue)	25¢		25¢		\$1.00
USA 7	1/50¢, 3/\$1.00 (1 to Start; 1 to Continue)	25¢		25¢		\$1.00
USA 8	1/50¢, 4/\$1.00 (2 to Start; 2 to Continue)	25¢		25¢		\$1.00
USA 9	1/25¢ (3 to Start; 2 to Continue)	25¢		25¢		\$1.00
USA 10	1/25¢ (3 to Start; 3 to Continue)	25¢		25¢		\$1.00
USA ECA	1/25¢, 4/\$1.00 (2 to Start; 2 to Continue)	\$1.00	10¢	25¢	5¢	\$1.00
German 1	1/1DM, 6/5DM	1DM		5DM		
German 2	1/1DM, 7/5DM	1DM		5DM		
German 3	1/1DM, 8/5DM	1DM		5DM		
German 4	1/1DM, 5/5DM	1DM		5DM		
German 5	1/1DM, 6/5DM	1DM		5DM		
German ECA	1/1DM, 2/2DM, 6/5DM	5DM	1DM	2DM		
France 1	2/5F, 5/10F	5F		10F		
France 2	2/5F, 4/10F	5F		10F		
France 3	1/5F, 3/10F	5F		10F		
France 4	1/5F, 2/10F	5F		10F		
France 5	2/5F, 5/10F, 11/2 x 10F	5F		10F		
France 6	2/5F, 4/10F, 9/2 x 10F	5F		10F		
France 7	1/5F, 3/10F, 7/2 x 10F	5F		10F		
France 8	1/5F, 2/10F, 5/2 x 10F	5F		10F		
France 9	1/3 x 1F, 2/5F	1F		5F		
France 10	1/2 x 1F, 3/5F	1F		5F		
France 11	1/3 x 1F, 2/5F, 5/2 x 5F	1F		5F		
France 12	1/2 x 1F, 3/5F, 7/2 x 5F	1F		FF		
France ECA	1/3 x 1F, 2/5F, 5/2 x 5F	1F	10F	5F		
Canada	1/2 x 25¢, 3/\$1.00	25¢		\$1.00		\$1.00
Swiss 1	1/1F, 6/5F	1F		5F		
Swiss 2	1/1F, 7/5F	1F		5F		
Swiss 3	1/1F, 8/5F	1F		5F		
Italy	1/500 lire	500 lire		500 lire		
UK 1	1/20P, 3/50P	20P		50P		
UK 2	2/20P, 5/50P	20P		50P		
UK ECA	1/20P, 3/50P, 7/£1.00	£1.00	20P	50P	10P	
UK Elec w/CCU	1/30P, 2/50P, 4/£1.00	£1.00	20P	50P	10P	
Spain 1	1/100 peseta, 6/500 peseta	100 peseta		500 peseta		
Spain 2	1/100 peseta, 5/500 peseta	100 peseta		500 peseta		
Australia 1	1/3 x 20¢, 2/\$1.00	20¢		\$1.00		
Australia 2	1/5 x 20¢, 1/\$1.00	20¢		\$1.00		
Japan 1	1/100 yen	100 yen		100 yen		
Japan 2	2/100 yen	100 yen		100 yen		
Austria 1	1/5 schilling, 2/10 schilling	5 schilling		10 schilling		
Austria 2	1/2 x 5 schilling, 3/2 x 10 schilling	5 schilling		10 schilling		
Belgium 1	1/20F	20F		20F		
Belgium 2	3/20F	20F		20F		
Belgium 3	2/20F	20F		20F		
Belgium ECA	1/20F	50F	5F	20F		
Sweden	1/3 x 1 krona, 2/5 krona	1 krona		5 krona		
New Zealand 1	1/3 x 20¢	20¢		20¢		
New Zealand 2	1/2 x 20¢	20¢		20¢		
Netherlands	1/1 HFI, 3/2.5 HFI	1 HFI		2.5 HFI		
Finland	1/1 markka	1 markka		1 markka		
Norway	1/2 x 1 krone, 3/5 x 1 krone	1 krone		1 krone		
Denmark	1/2 x 1 krone, 3/5 krone, 7/2 x 5 krone	1 krone		5 krone		
Antillies	1/25¢, 4/1 guilder	25¢		1 guilder		
Hungary	1/2 x 10 forint, 3/2 x 20 forint	10 forint		20 forint		

KILLER INSTINCT

- (1) LEFT CHUTE UNITS
- (1) RIGHT CHUTE UNITS
- (1) CHUTE 3 UNITS
- (1) CHUTE 4 UNITS
- (1) BILL UNITS
- (2) UNITS/CREDITS
- (3) UNITS/BONUS
- (4) MINIMUM UNITS
- (5) CREDITS TO START
- (6) CREDITS TO CONTINUE
- (7) MAXIMUM CREDITS
- RETURN TO ADJ. MENU

CUSTOM PRICING MENU

- (1) Coins inserted accumulate units. This adjustment specifies the number of units given for each coin in the fourth chute (see "units/credit").
- (2) This is the number of coin units required to buy one credit.
- (3) There is one bonus credit awarded after this many coin units have accumulated.
- (4) This is the minimum number of units required before any credits are awarded.
- (5) Each player needs this many credits to begin a game.
- (6) Each player needs this many credits to continue a game.
- (7) This is the limit for the credit counter. Additional coins inserted will be lost (factory setting: 30).

UTILITIES

The Utilities Menu allows the operator to clear the game's bookkeeping memory.

Use either joystick to select the Utilities Menu, then press any button.

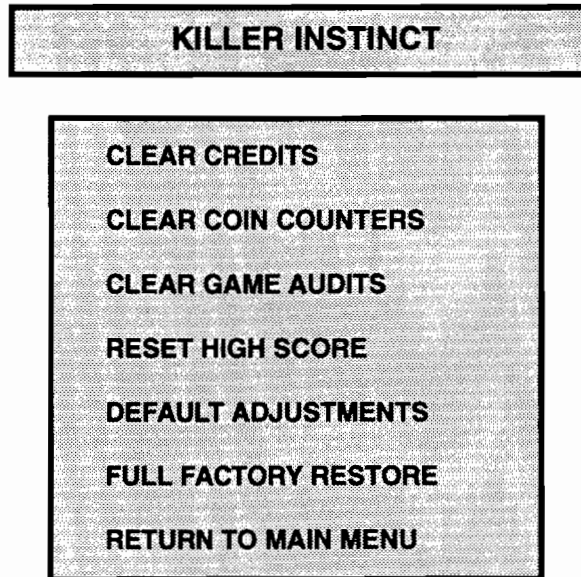

UTILITIES MENU

Use either joystick to select a utility. Press any button to activate the selection. A dialogue box appears and the operator can choose to reset the utility. For example:

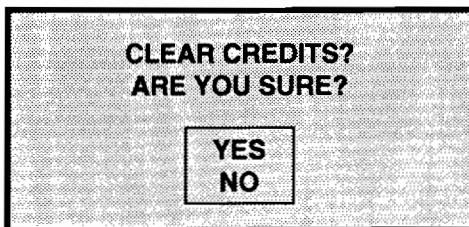

Use either joystick to choose a setting value. Press any button to lock in the new setting value.

To exit the Utilities Menu, use either joystick to select RETURN TO MAIN MENU, then press any button.

VOLUME ADJUST

The Volume Adjust feature allows the operator to determine the sound and music level of the game.

The volume level can be adjusted from either the Attract Mode or the Menu System. Press the Volume Up button to raise the volume level and the Volume Down button to lower the volume level. Either joystick can also be used to raise or low the volume level. The current volume level is shown with a red bar. Press the any button to return to the Main Menu.

VOLUME ADJUST PRESS ANY BUTTON TO EXIT

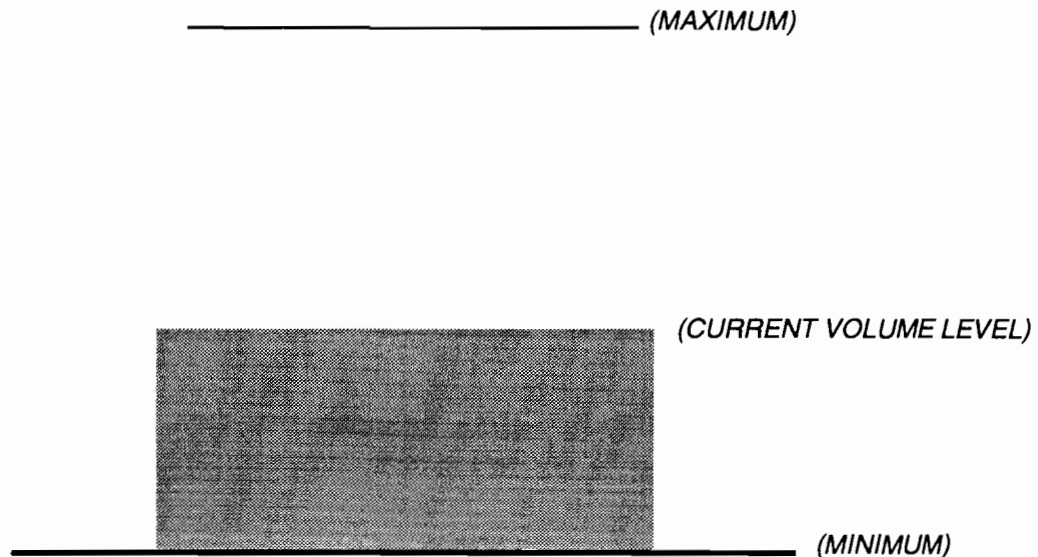

TROUBLESHOOTING

PROBLEM

No picture or distorted picture.

POSSIBLE SOLUTION

Check for faulty video board or monitor. Check for disconnected video signal cable.

Turn game On and nothing happens.

Check line fuse. Check for +5Vdc at pins C, D, 3 and 4 of the JAMMA connector.

No sound.

Check the speaker and the speaker connection to pin L and 10 on the JAMMA connector. Check volume control setting. Check for +12Vdc at pins F and 6 on the JAMMA connector. Check for -5Vdc at pins E and 5 on the JAMMA connector.

Press start button and nothing happens.

Check for open wires between the button and the CPU board. Check for contamination on CPU board pins or the Start button switch blade contacts. Check for proper ground.

No credit given for number of coins inserted.

Check DIP switch coin settings. Check for contamination on the coin switch contacts. Check for an open wire between Coin Switch 1 and pin 16 on the JAMMA connector or Coin Switch 2 and pin T of the JAMMA connector.

Too many credits for number of coins inserted.

Check the game pricing settings. Check for a short between pins T & 16 on the JAMMA connector.

Game stay in test mode.

Check that the switch #8 of DIP switch bank #2 is set to off.

KILLER INSTINCT KIT

**SECTION
two**

Parts

CPU/Sound Assembly A-19650-40047

Designation	Part Number	Description
U98	A-5343-40047-1	Game EPROM
U10	A-5343-40047-2	Sound EPROM
U11	A-5343-40047-3	Sound EPROM
U12	A-5343-40047-4	Sound EPROM
U13	A-5343-40047-5	Sound EPROM
U33	A-5343-40047-6	Sound EPROM
U34	A-5343-40047-7	Sound EPROM
U35	A-5343-40047-8	Sound EPROM
U36	A-5343-40047-9	Sound EPROM
S1, S2	5645-09025-00	DIP Switch
J3	5791-12461-10	Header, 10-pin
J6	5791-14457-00	Header, 44-pin
J7	5791-12461-15	Header, 15-pin
J8	5791-12461-08	Header, 8-pin

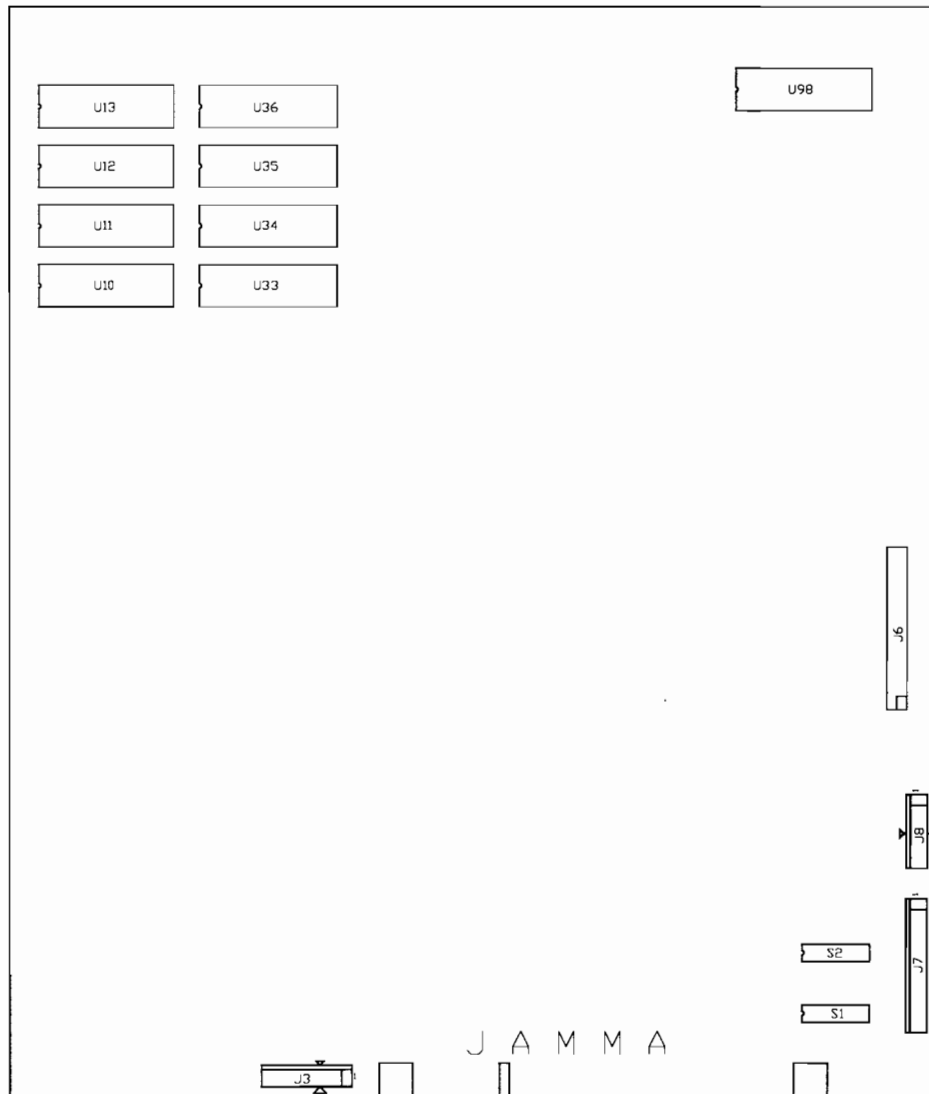

Hard Drive Mounting Bracket A-19595.1

Side View

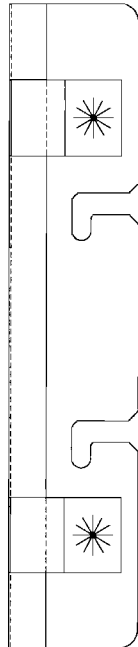

Front View

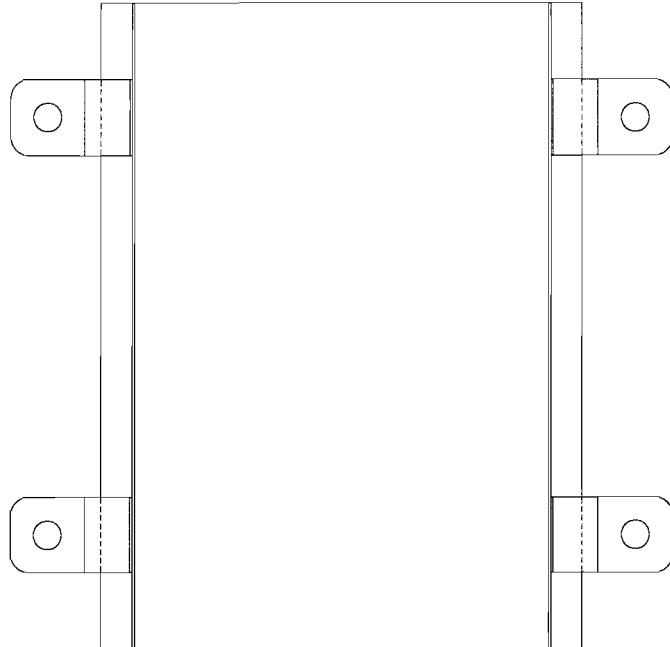

Complete Hard Drive Assembly Diagram

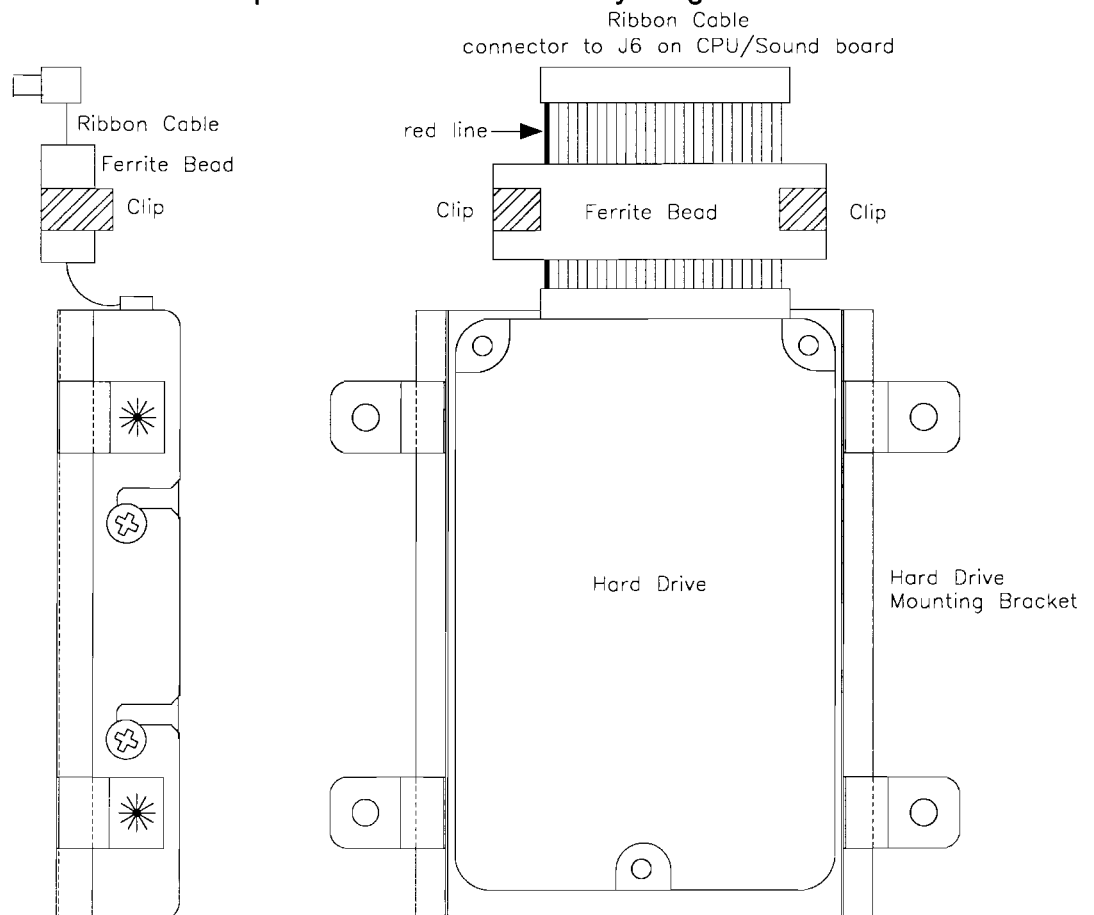

**Fan
20-9947**

Side View

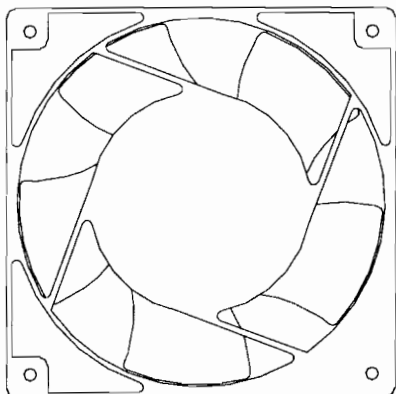

Front View

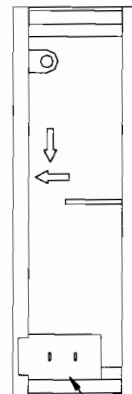

AC Connector

**Fan Mounting Bracket
A-19806**



LONG SIDE

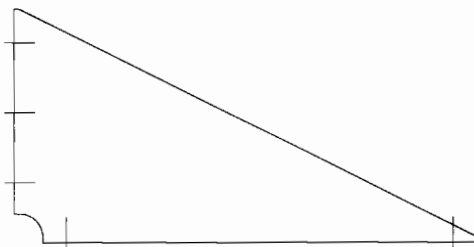

FRONT



SHORT SIDE

Complete Fan Assembly Diagram

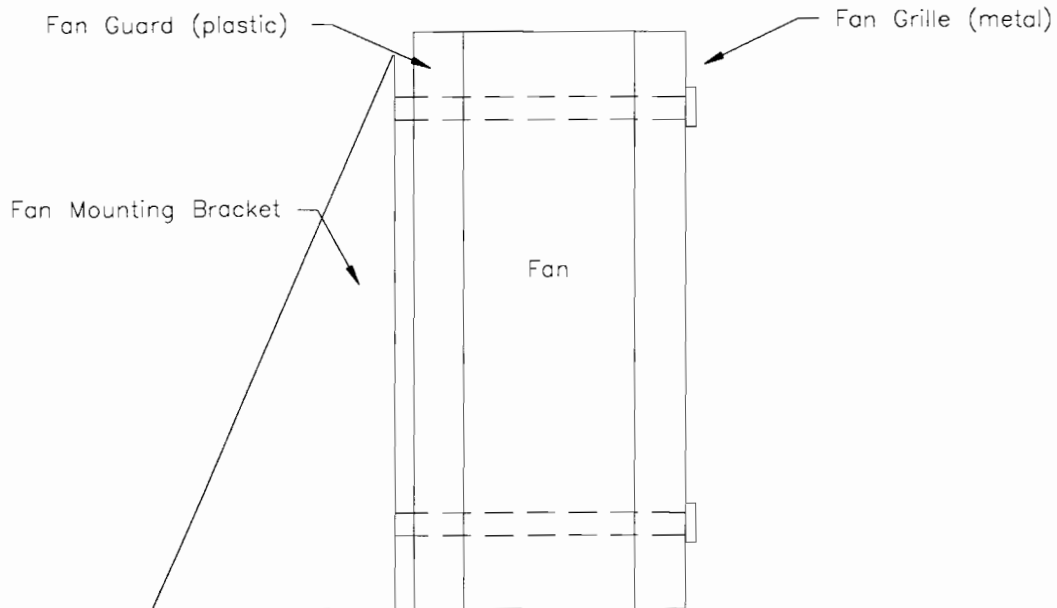

KILLER INSTINCT KIT

**SECTION
three**

Wiring Diagrams

JAMMA Chart

FUNCTION	WIRE COLOR	PIN	PIN	WIRE COLOR	FUNCTION
Ground	Black	A	1	Black	Ground
Ground	Black	B	2	Black	Ground
+5VDC	Red	C	3	Red	+5VDC
+5VDC	Red	D	4	Red	+5VDC
-5VDC	Yellow	E	5	Yellow	-5VDC
+12VDC	Orange	F	6	Orange	+12VDC
	Key	H	7	Key	
Coin Counter 2	Brown-Red	J	8	Brown	Coin Counter 1
	N/C	K	9	N/C	
Speaker-	Brown-Gray	L	10	Red-Gray	Speaker+
	N/C	M	11	N/C	
Video Green	Green	N	12	Red	Video Red
Video Sync	White	P	13	Brown	Video Blue
Service Credits	White-Gray	R	14	Shield	Video Ground
Slam Tilt	Black-Green	S	15	Black-Blue	Test
Coin 2	Black-Red	T	16	Black-Brown	Coin 1
2 Start	Violet-White	U	17	White	1 Start
2 Up	Violet-Black	V	18	White-Black	1 Up
2 Down	Violet-Brown	W	19	White-Brown	1 Down
2 Left	Violet-Red	X	20	White-Red	1 Left
2 Right	Violet-Orange	Y	21	White-Orange	1 Right
2 Quick/High	Violet-Yellow	Z	22	White-Yellow	1 Quick/High
2 Medium/High	Violet-Green	a	23	White-Green	1 Medium/High
2 Fierce/High	Violet-Blue	b	24	White-Blue	1 Fierce/High
Not Used	Violet	c	25	White-Violet	Not Used
	N/C	d	26	N/C	
	N/C	e	27	N/C	
Ground	Black	f	28	Black	Ground
SOLDER SIDE			COMPONENT SIDE		

Interboard Wiring

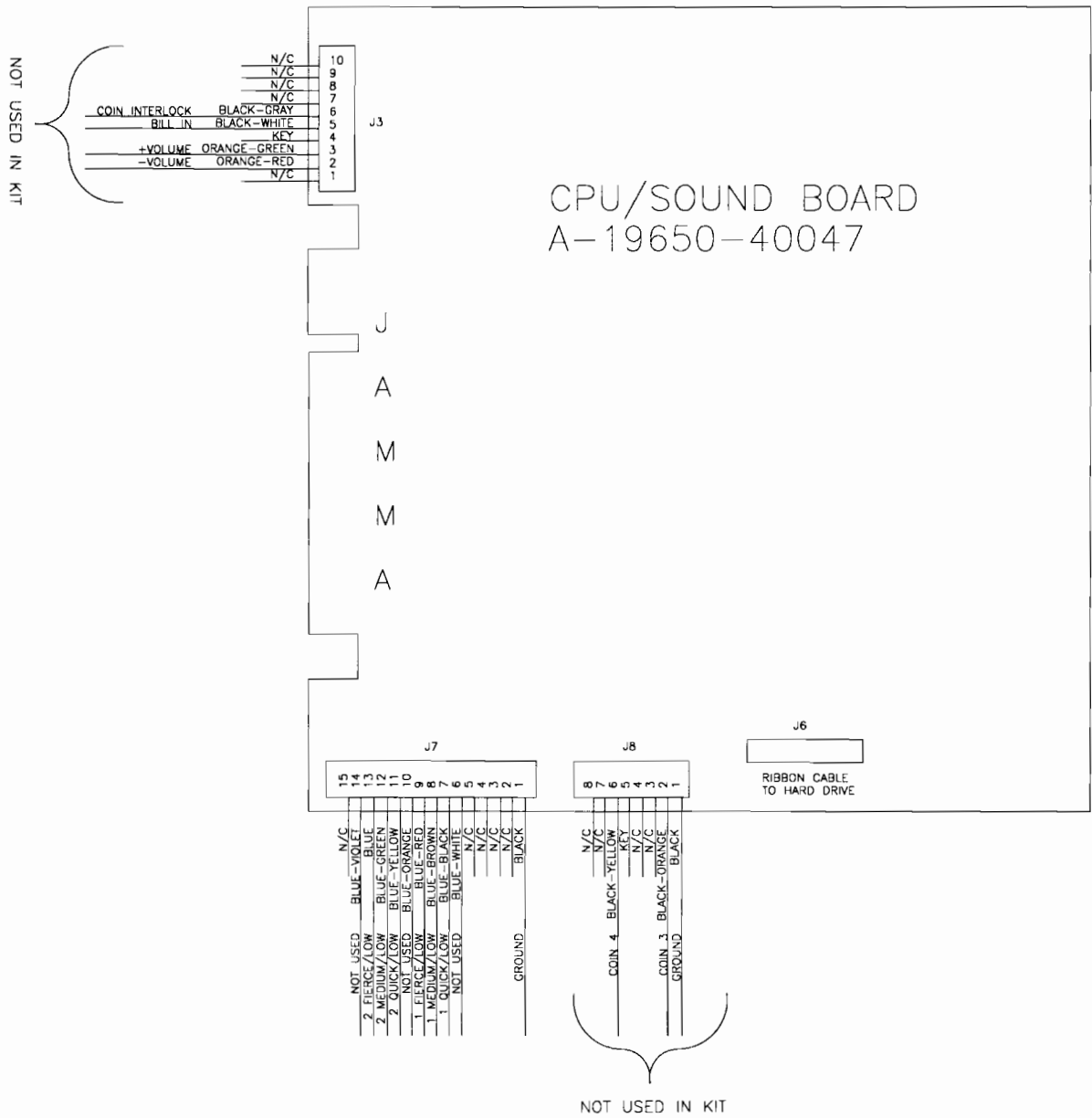

Coin Switch and Meter Wiring

Option 1

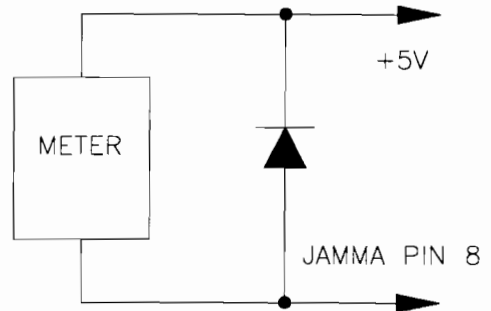
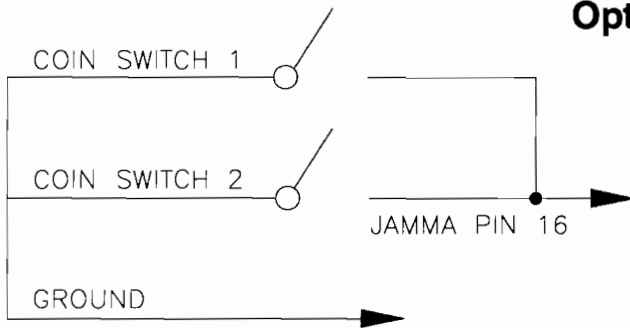

Option 2

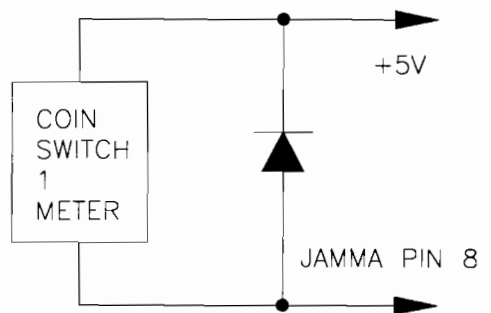
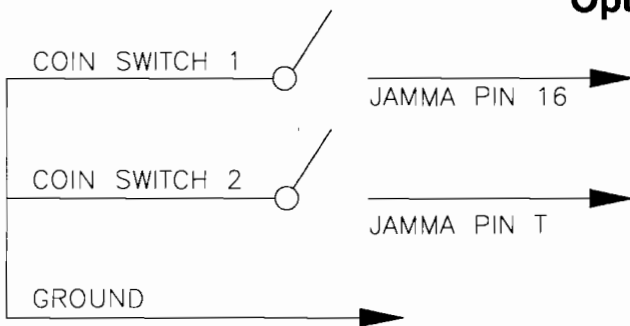

!! WRONG WAY !!

Do not connect the coin switches in this manner. This circuit is INCORRECT and will cause twice as many credits per coin.

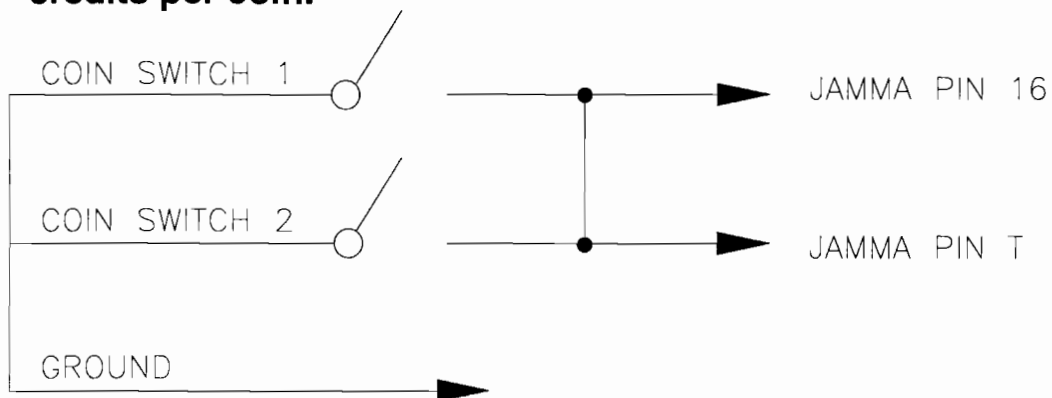

Cabinet Wiring

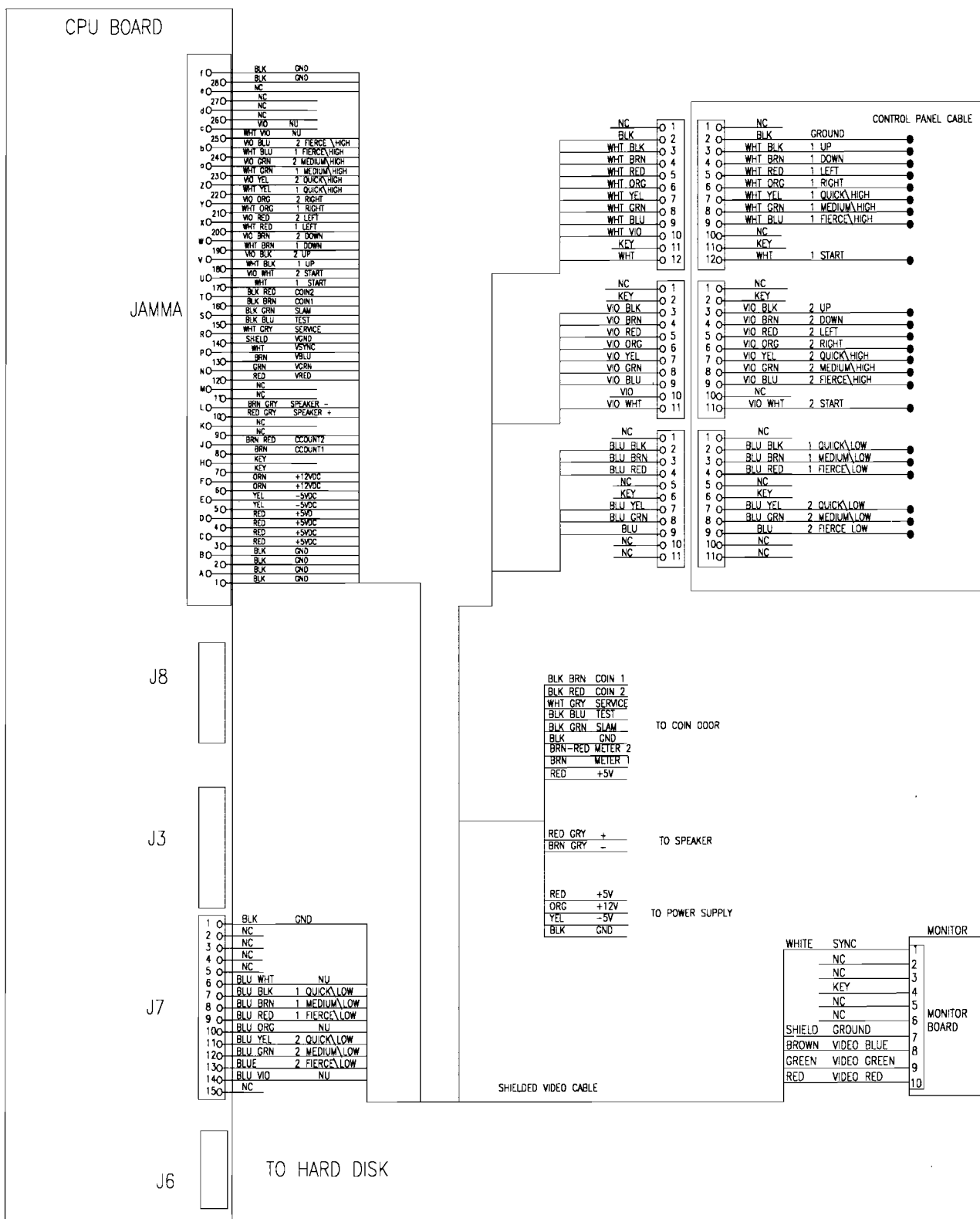

Electronic Rack Assembly

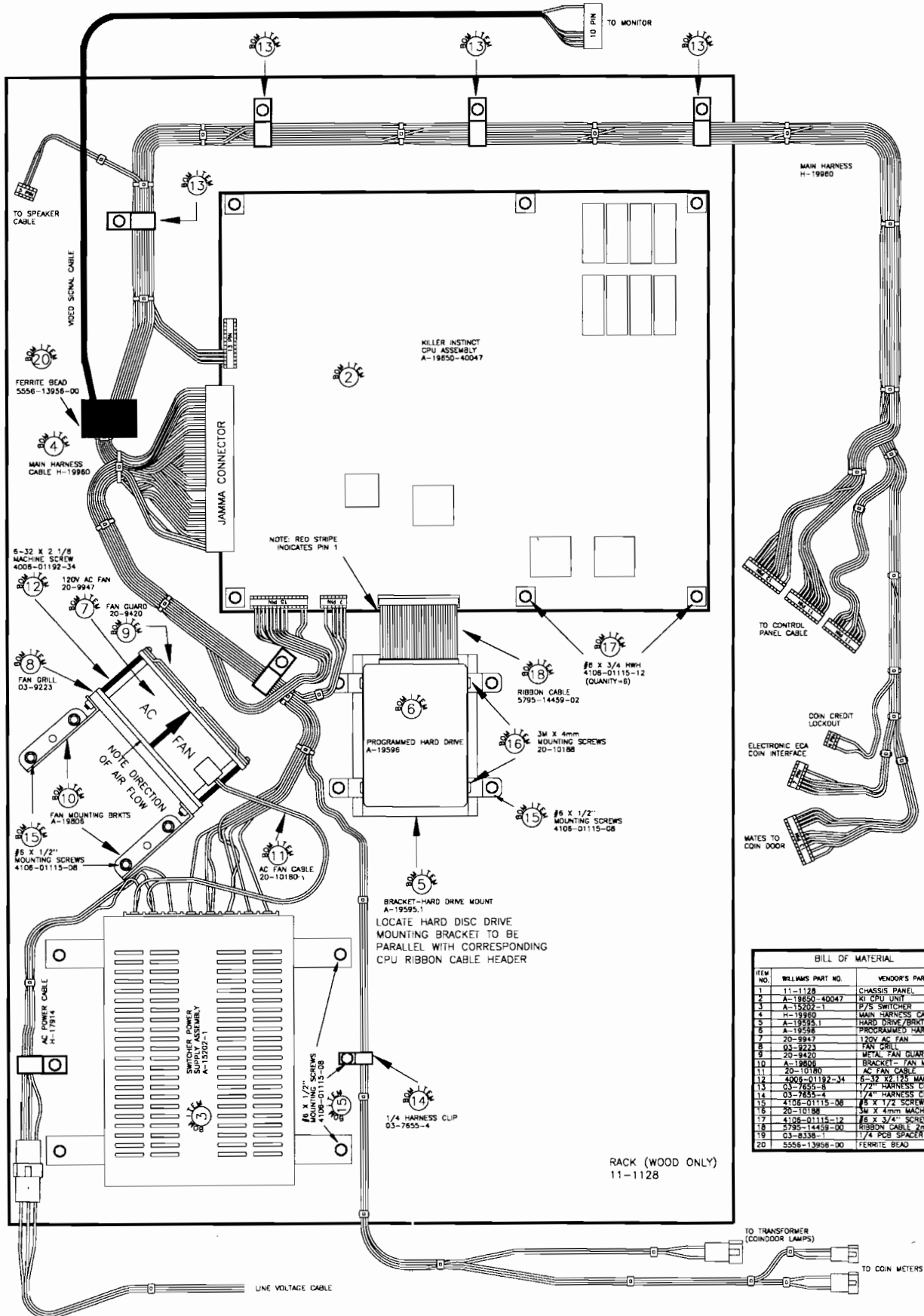

ITEM NO.	WILLIAMS PART NO.	VENDOR'S PART NO.
1	11-1128	CHASSIS PANEL
2	A-19850-40047	KT CPU UNIT
3	A-19309-1	72'S SWITCHER
4	H-19980	MAIN HARNESS CABLE
5	A-19395-1	HARD DRIVE/BRKT ASM
6	A-19396	PROGRAMMED HARD DISK
7	20-9947	120V AC FAN
8	03-9223	FAN DRILL
9	20-9420	METAL FAN GUARD
10	A-19808	BRACKET-FAN MOUNT
11	20-10180	AC FAN CABLE
12	4008-01192-34	6-32 X 2 1/8 MACH SCREW
13	03-7655-4	1/2" HARNESS CLIP
14	03-7655-4	1/4" HARNESS CLIP
15	4108-01115-08	#5 X 1/2" SCREW
16	20-10188	3M X 4mm MACH SCREW
17	4108-01115-12	#6 X 3/4" SCREW
18	5795-14459-02	RIBBON CABLE 2mm-2.125"
19	03-8338-1	1/4 PCB SPACER
20	5556-13958-00	FERRITE BEAD

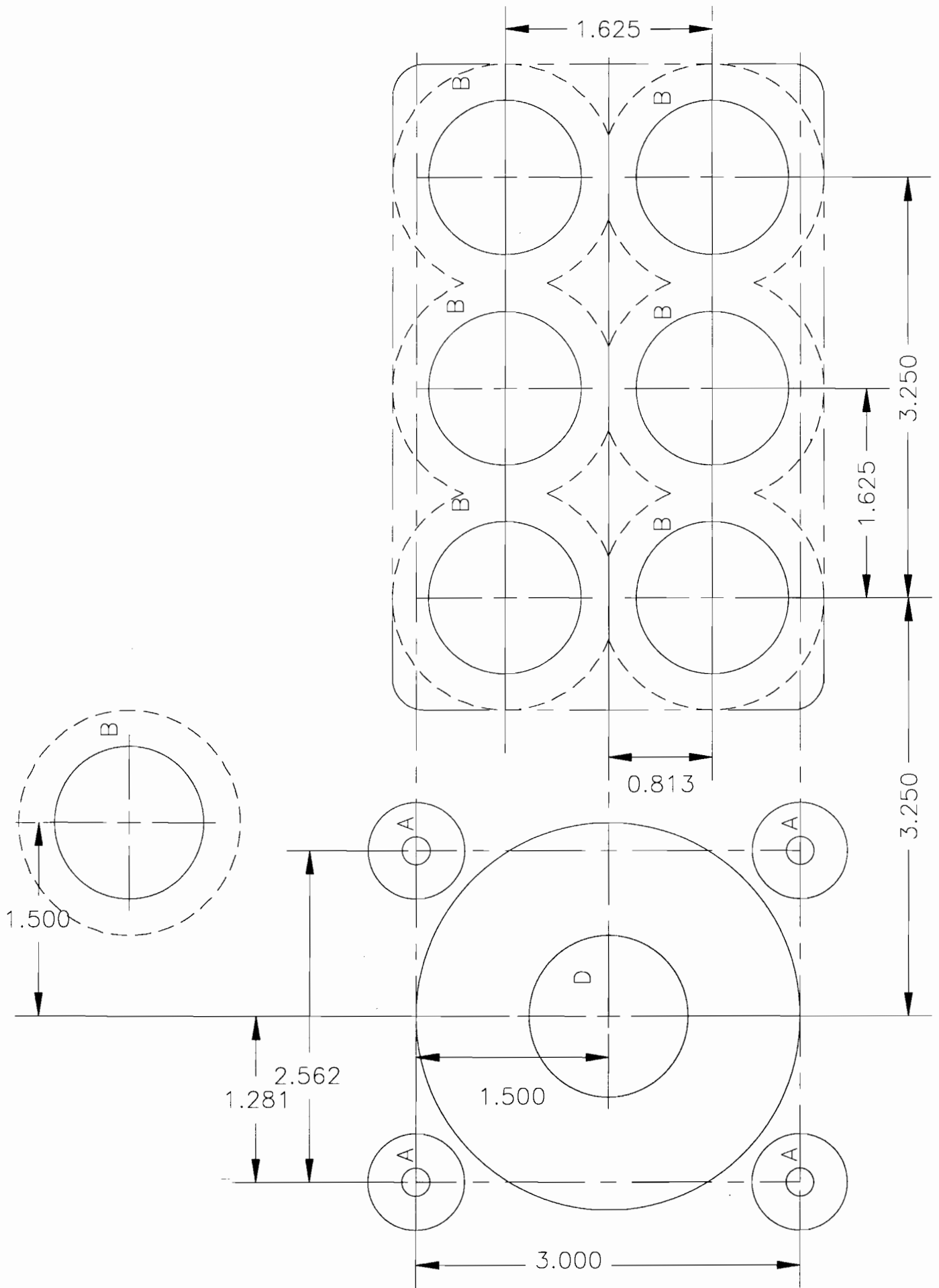

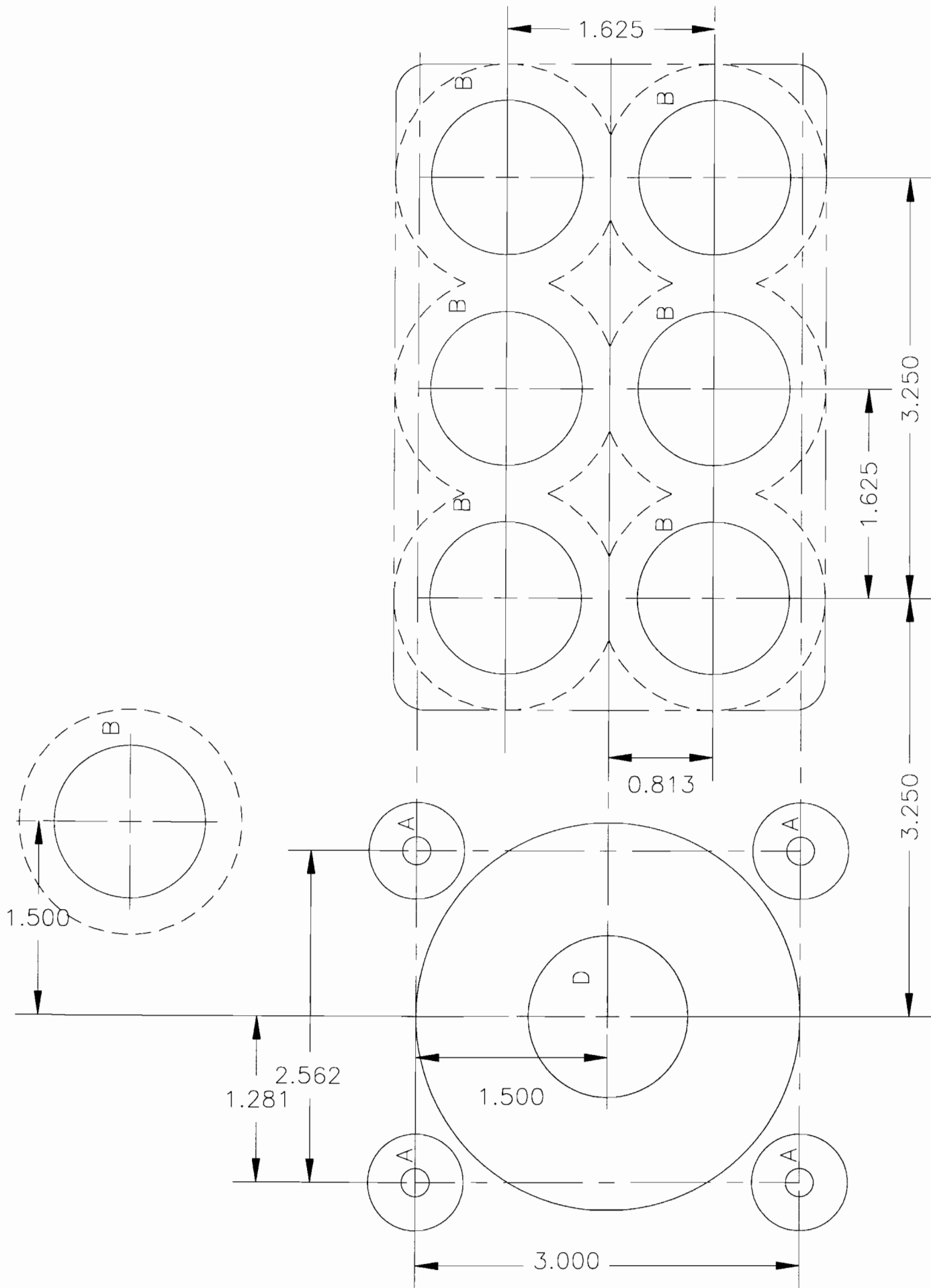

CONTROL PANEL WIRE COLORS

Player One

Start	White
Up	White-Black
Down	White-Brown
Left	White-Red
Right	White-Orange
Quick/High	White-Yellow
Medium/High	White-Green
Fierce/High	White-Blue
Quick/Low	Blue-Black
Medium/Low	Blue-Brown
Fierce/Low	Blue-Red
Ground	Black

Player Two

Start	Violet-White
Up	Violet-Black
Down	Violet-Brown
Left	Violet-Red
Right	Violet-Orange
Quick/High	Violet-Yellow
Medium/High	Violet-Green
Fierce/High	Violet-Blue
Quick/Low	Blue-Yellow
Medium/Low	Blue-Green
Fierce/Low	Blue
Ground	Black

WARNING & NOTICES

WARNING

USE OF NON-MIDWAY PARTS OR CIRCUIT MODIFICATIONS MAY CAUSE SERIOUS INJURY OR EQUIPMENT DAMAGE! USE ONLY MIDWAY AUTHORIZED PARTS.

* For safety and reliability, substitute parts and modifications are not recommended.

* Substitute parts or modifications may void FCC type acceptance.

* This game is protected by federal copyright, trademark and patent laws. Unauthorized modifications may be illegal under federal law. This also applies to MIDWAY logos, designs, publications and assemblies. Moreover, facsimiles of MIDWAY equipment (or any feature thereof) may be illegal under federal law, regardless of whether or not such facsimiles are manufactured with MIDWAY components.

WARNING

NOTE: This equipment has been tested and found to comply with the limits for a Class A digital device, pursuant to Part 15 of the FCC Rules. These limits are designed to provide reasonable protection against harmful interference when the equipment is operated in a commercial environment. This equipment generated, uses and can radiate radio frequency energy and if not installed and used in accordance with the instruction manual, may cause harmful interference to radio communications. Operation of this equipment in a residential area is likely to cause harmful interference in which case the user will be required to correct the interference at his own expense.

WARNING

Prevent shock hazard and assure proper game operation. Only plug this game into a properly grounded outlet. Do not use a cheater plug to defeat the power cord's grounding pin. Do not cut off the ground pin.

NOTICE - FCC WARNING STICKER

- I. **THIS KIT WAS TESTED IN A MIDWAY UNIVERSAL VIDEO CABINET AND FOUND TO COMPLY WITH FCC PART 15 CLASS A REQUIREMENTS. IF INSTALLED IN MIDWAY UNIVERSAL VIDEO CABINET, THE FCC WARNING STICKER (16-9306) SUPPLIED IS TO BE PLACED ON THE REAR OF THE CABINET.**
- II. **INSTALLATION OF THIS KIT INTO ANY OTHER PRODUCT DOES NOT GUARANTY COMPLIANCE WITH FCC REQUIREMENTS. YOU ARE SOLELY RESPONSIBLE, AND MIDWAY WILL HAVE NO RESPONSIBILITY, FOR FCC COMPLIANCE FOR INSTALLATIONS IN OTHER PRODUCTS. THE FCC WARNING STICKER SUPPLIED SHOULD NOT BE INSTALLED ON THE CONVERTED PRODUCT UNTIL FCC COMPLIANCE IS VERIFIED.**

NOTICE

No part of this publication may be reproduced by any mechanical, photographic, or electronic process, or in the form of a phonographic recording, nor may be transmitted, or otherwise copied for public or private use, without permission from the publisher.

FOR SERVICE: CALL YOUR AUTHORIZED MIDWAY DISTRIBUTOR.

Killer Instinct™

© 1994 Nintendo/Rare

Game by Rare

Killer Instinct is a trademark of Nintendo

Manufactured and sold by Midway Manufacturing Company under license

**MIDWAY MANUFACTURING COMPANY
3401 N. CALIFORNIA AVE.
CHICAGO, IL 60618**