

Meadows

LAZER COMMAND

Model LC-1

LAZER COMMAND

Model LC-1

TABLE OF CONTENTS

- 1- INTRODUCTION
- 2- WARRANTY INFORMATION
- 3- SETUP AND CHECKOUT
- 4- GAME SEQUENCE
- 5- CABINET ENTRY
- 6- COIN ACCEPTOR
- 7- ADJUSTMENTS/MAINTENANCE
 - 4-WAY CONTROL HANDLES
 - DRIVERS EJECT BUTTONS
 - NOVICE/EXPERT SWITCHES
 - COINS PER GAME
 - GAME TIMER
 - DISPLAY MONITOR
 - PCB REMOVAL
- 8- TROUBLE SHOOTING HINTS

ILLUSTRATIONS

- FIGURE #1 COIN MECHANISM
- FIGURE #2 LOGIC PCB
- FIGURE #3 4-WAY CONTROL HANDLE
- FIGURE #4 WIRE HARNESS
- FIGURE #5 MONITOR MANUAL

INTRODUCTION

LAZER COMMAND, a game of skill and strategy, is a game that depicts a futuristic battle between two groups of nuclear powered lazer tanks. The object of the game is to blow up all 15 enemy tanks while trying to evade being hit by opponent's shooting lazars. The two opposing tanks are separated by either a simple "NOVICE" maze or a complex "EXPERT" maze. Only one of each player's tank can move or shoot its lazer at a time, and this tank must be occupied by its respective driver. "For strategic purposes" the driver can be moved at any-time from tank to tank. (See Section "DRIVERS EJECT BUTTON," page 3.)

WARRANTY

PRINTED CIRCUIT BOARDS: Contact the distributor from whom the game was purchased for warranty repair and/or replacement information.

NOTE: Any PCB repair attempted by anyone other than factory authorized service people, or any damage due to improper handling or use shall void any existing warranty. Proper procedures for removal and replacement, as outlined in manual, must be adhered to.

DISPLAY MONITOR: Contact the distributor from whom the game was purchased for warranty repair and/or replacement information.

NOTE: Any monitor repair attempted by anyone other than factory authorized people, or any damage due to improper handling or use, shall void any existing warranty.

ALL EQUIPMENT RETURNED TO THE FACTORY MUST HAVE RETURN AUTHORIZATION NUMBER AND TRAVEL FREIGHT PREPAID. PLEASE LIST SYMPTOMS OR PROBLEMS TO EXPEDITE REPAIRS.

LAZER COMMAND SETUP AND CHECKOUT

When the game is received and unpacked, save all packing materials in the event that it was damaged and must be returned. After reading "CABINET ENTRY" section, proceed to inspect the interior of the cabinet for loose or damaged connectors, wires, hardware, etc. If everything seems in satisfactory condition, plug the game in and play it as described in the section "GAME SEQUENCE." For questions about length of play time, coins per game, sound level, or anything relating to picture image, see the section "ADJUSTMENTS/MAINTENANCE."

GAME SEQUENCE

CONTROL AND SWITCH FUNCTIONS

COIN: Operator selectable:

1 coin, 25¢, per play

2 coins, 50¢, per play

START NOVICE/START EXPERT: Generates a simple or a complex maze on the display monitor and starts the game.

4-WAY CONTROL HANDLE: Allows maneuvering in any one of 4 directions at a time. UP, DOWN, LEFT, RIGHT.

DRIVERS EJECT BUTTON: Momentarily pressing EJECT BUTTON while actuating the control handle ejects the driver out of his tank. NOTE: It is not necessary to keep the EJECT BUTTON constantly depressed - only long enough to get driver out of tank he is presently in. To enter another tank, after ejecting of after being blown up, a driver simply moves into another of his own tanks by moving the control handle. The driver from one side will not operate tanks of the opposing player.

DISPLAY MONITOR: The upper left hand corner shows the time remaining during or at the end of game, and the upper middle section indicates coin credits. The lower left and right corners depict the number of enemy tanks 'blown up' by the respective left and right player. The central area of the display shows the maze battlefield. The game ends when either all tanks of one player are blown up or if the time clock has run out. When the game has ended the word WINNER will be displayed on the side having blown up the largest number of enemy tanks. In the case of a tie, the word DRAW will appear in the center of the screen.

CABINET ENTRY

Entry into the LAZER cabinet is at three points: the coin door, the back door, and the control panel.

COIN DOOR

The coin door is hinged to open from right to left giving access to the following:

- Coin Box
- Coin Mechanism
- Control Panel Wing Nuts

BACK DOOR

The back door tilts out from the top and lifts up for removal. This allows access to the following:

- Display Monitor
- Harness
- Logic PCB

CONTROL PANEL

To open the control panel open the coin door first. Remove the two wing nuts located up towards the control panel to the left and right. Finally, swing the control panel away from the cabinet. This will give access to the following:

- Cleaning Monitor/Inner Plexiglass
- 4-Way Control Handles
- Plexiglass Removal (for instruction cards)
- Left Eject Switch
- Right Eject Switch
- Speaker
- Start Expert Switch
- Start Novice Switch

COIN ACCEPTOR OPERATION, ADJUSTMENT AND MAINTENANCE

SEE FIGURE 1

The detection and rejection of undesired or counterfeit coins are determined by size (both thickness and diameter), weight and metallic composition.

The transfer cradle (#9) is used to test both the size and weight of the coin. The coin must first pivot an "undersize" lever (10) to

unlock the transfer cradle and can be returned by actuating the wiper operating lever (17). Oversize diameter coins will fail to pass between the transfer cradle and the wiper and can be returned by operating the wiper lever. Coins that are oversize in thickness will fail to pass between the magnet gate (11) and the main channel (5) and will have to be dislodged by actuating the wiper operating lever. Underweight coins will fail to overcome the transfer cradle counterweight and can be returned by operating the wiper lever.

A magnet is used to test the metallic composition of the coin. Highly magnetic coins, such as steel or iron, will be retained by the magnet and can be returned by actuating the wiper operating lever. Coins having comparatively high magnetic properties will be slowed down by the magnet and will drop off the rail short of the accept entrance and will be returned. Coins having little or no magnetic properties, such as brass or zinc, will pass through the magnetic field so fast they will overshoot the accept entrance and will be returned.

ADJUSTMENT

All coin acceptors leave the factory adjusted for maximum performance. If, however, more critical adjustment is desired, or if the unit has been disassembled for cleaning, the following adjustment procedure is suggested.

KICKER AND SEPARATOR

- a. Set the acceptor on a level surface with the back of the unit facing you (the kicker and separator are on the back).
- b. Loosen the screws holding the kicker (1) and the separator (3) and move both the kicker (2) and the separator (4) as far to the right as they will go. Tighten the screws lightly.
- c. Insert several test coins (both old and new) and note that some are returned by striking the separator.
- d. Loosen the separator screw and move the separator a slight amount to the left. Retighten the screw.
- e. Insert the test coins again, and if some are still returned, repeat Step d until all coins are accepted.
- f. Loosen the kicker screw and move the kicker a slight amount to the right.
- g. Insert the test coins again and, if some of them are returned, repeat Step f until all coins are accepted.
- h. Be sure that both screws are tight after the adjustments have been made.

THE MAGNETIC GATE

- a. Set the acceptor with the front of the unit facing you in the test position.
- b. Turn the magnet gate adjustor (12) out (counter-clockwise) until none of the coins will fit through.

- c. With a coin resting in the transfer cradle, turn the adjustor in (clockwise) until the coin barely passes through the magnet gate.
- d. Test this adjustment using several coins, and if any fail to pass through the magnet gate, repeat Step c until all coins are accepted.
- e. Fix the gate adjustor in this position with a drop of glue or Loctite, if necessary.

ACCEPTOR MAINTENANCE

Depending on the environment in which the acceptor is used, periodic preventative maintenance should be performed.

The mainplate (5) may be cleaned with any liquid household cleaner. Thorough rinsing and drying are necessary to remove deposits and/or film. Remove all metal particles from the magnet by guiding a screwdriver along the edges of the magnet. Remove the transfer cradle and undersize lever and clean the bushings and pivot pins and re-assemble. Spray the entire unit lightly with WD-40, a silicone lubricant.

4-WAY CONTROL HANDLES, ADJUSTMENT AND MAINTENANCE

These controls are factory set and need no adjustment. However, if switch replacement is necessary, simply remove connector and two screws holding switch to plate. For fire button removal, unscrew with appropriate tool or with a pair of regular pliers. Then remove slide on terminals.

DRIVERS EJECT BUTTON SWITCHES, ADJUSTMENT AND MAINTENANCE

If access to these switches is required see the section, "CABINET ENTRY."
To remove either of these switches, disconnect the slide on terminals
and undo the 9/16" nut holding the switch to the control panel.

NOVICE/EXPERT SWITCHES

In the event these switches need to be removed for replacement, gain
access to them by following directions under the section, "CABINET ENTRY."
Continue by removing the 9/16" nut holding the switch to the control
panel.

COINS PER GAME, ADJUSTMENT

The number of plays per coin is switch adjustable to either 1 coin per
game or 2 coins per game. See the illustration of the Logic PCB for
switch details.

GAME TIME, ADJUSTMENT

Length can be set to either 1, 1.5, 2, or 3 minutes. See illustration
of Logic PCB for switch details.

DISPLAY MONITOR, ADJUSTMENT AND MAINTENANCE

The display monitor contains the following adjustments from left to right:

Contrast: Adjustment for clear picture

Brightness: Adjustment to suit location

Vertical Hold: Adjustment if picture flips

Horizontal Hold: Adjustment if picture has diagonal lines
or is distorted

Volume: Adjustment to suit location noise level

For any maintenance see your "DISPLAY MONITOR MANUAL."

For access to display monitor see "Back Door" section under "CABINET ENTRY."

PCB REMOVAL

Before removing PCB's, power cord should be disconnected. Note the position of PCB to the connector to ensure proper connection upon replacement.

TROUBLE SHOOTING HINTS

TESTING COMPONENTS OF GAME

BUTTONS & COIN SWITCH are normally closed. When pushed they are open. The buttons can be by-passed by pulling off one of the terminals.

HARNESS can be tested by an ohm-meter or continuity checker.

FUSES are checked by visual inspection or continuity checker.

LOGIC PCB & TV MONITOR can be checked by substitution of a good replacement. Repair of logic PCB & monitor should only be serviced by experienced technicians.

NO PICTURE: Check if back of picture tube is lit, if not, inspect fuses, power cord, and power outlet. If these are good and tube is not lit, repair of monitor is necessary.

If the tube is lit, check adjustments of brightness and contrast. Test continuity of logic board pins #1 and #3 (5 volt dc power supply), and pin #5 (video output). If all check out, the problem is either the logic PCB or the monitor.

NO SOUND: Check the adjustment of the volume control on the TV monitor. Test the continuity of the logic PCB J2-Pin 11 (audio signal), and the monitor pins #5 and #8 (speaker wires). Check the speaker, logic PCB, and TV monitor.

- 1 KICKER SCREW
- 2 KICKER
- 3 SEPARATOR SCREW
- 4 SEPARATOR
- 5 MAINPLATE ASSEMBLY
- 6 GATE ASSEMBLY
- 7 COVERPLATE ASSEMBLY
- 8 RAIL
- 9 CRADLE ASSEMBLY
- 10 UNDERSIZE LEVER
- 11 MAGNET GATE ASSEMBLY
- 12 MAGNET GATE ADJUSTER SCREW
- 13 LOWER GATE PIVOT SPRING
- 14 UPPER GATE PIVOT SPRING
- 15 GATE PIVOT PIN
- 16 WIPER LEVER SPRING
- 17 WIPER LEVER
- 18 WIPER

REVISIONS			
LTR	DESCRIPTION	DATE	APPROVED

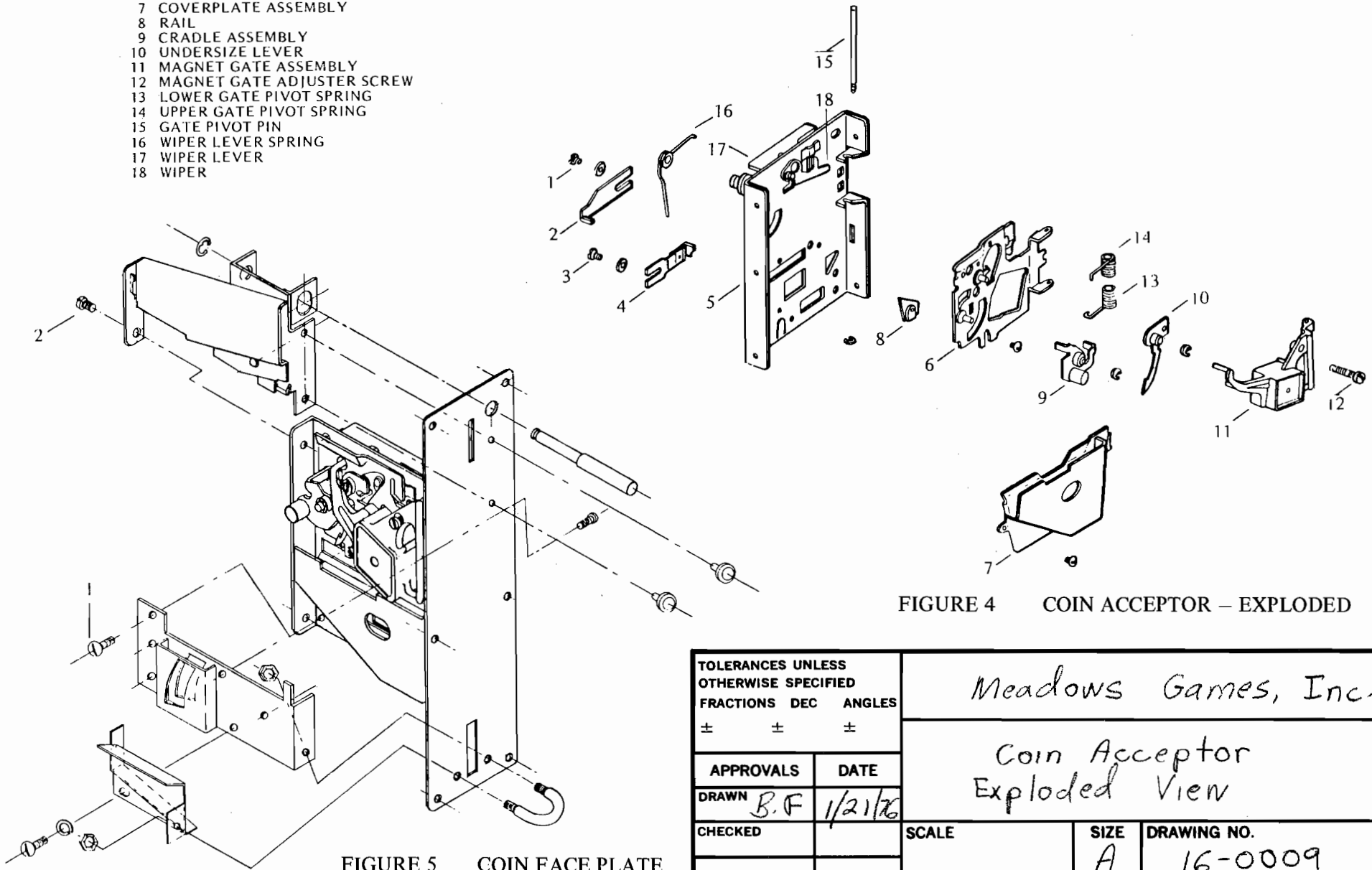
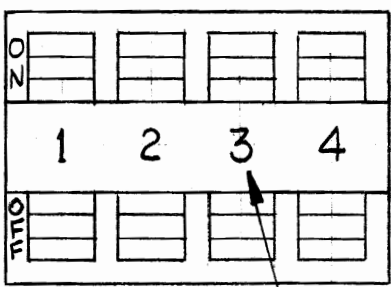
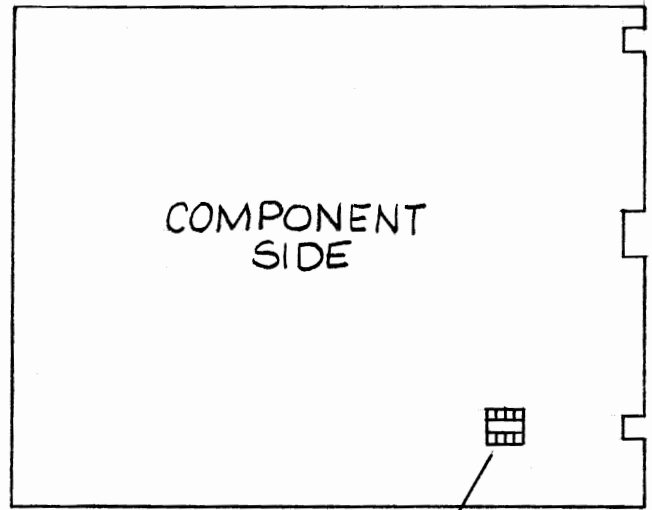

FIGURE 4 COIN ACCEPTOR - EXPLODED

FIGURE 5 COIN FACE PLATE

TOLERANCES UNLESS OTHERWISE SPECIFIED		Meadows Games, Inc.	
FRACTIONS	DEC		
±	±	±	
APPROVALS	DATE	Coin Acceptor Exploded View	
DRAWN B.F.	1/21/76		
CHECKED		SCALE	SIZE A
			DRAWING NO. 16-0009
DO NOT SCALE DRAWING			SHEET 1 OF 1

REVISIONS			
LTR	DESCRIPTION	DATE	APPROVED



— THIS POSITION NOT USED

SWITCH NUMBER			FUNCTION
1	2	4	
ON	ON	-	180 SECONDS
OFF	ON	-	120 SECONDS
ON	OFF	-	90 SECONDS
OFF	OFF	-	60 SECONDS
-	-	ON	2 COIN GAME
-	-	OFF	1 COIN GAME

TOLERANCES UNLESS OTHERWISE SPECIFIED FRACTIONS DEC. ANGLES ± - ± - ± -		MEADOWS GAMES, INC. 181 COMMERCIAL ST. SUNNYVALE, CA. 94086	
APPROVALS		DATE	
DRAWN <i>[Signature]</i>		10-27-76	
CHECKED <i>[Signature]</i>		10/27/76	
P. Williams		10/27/76	
D.A. Smith		11-3-76	
SCALE		SIZE	DRAWING NO.
NONE		B	016-0077
DO NOT SCALE DRAWING			SHEET 1 OF 1

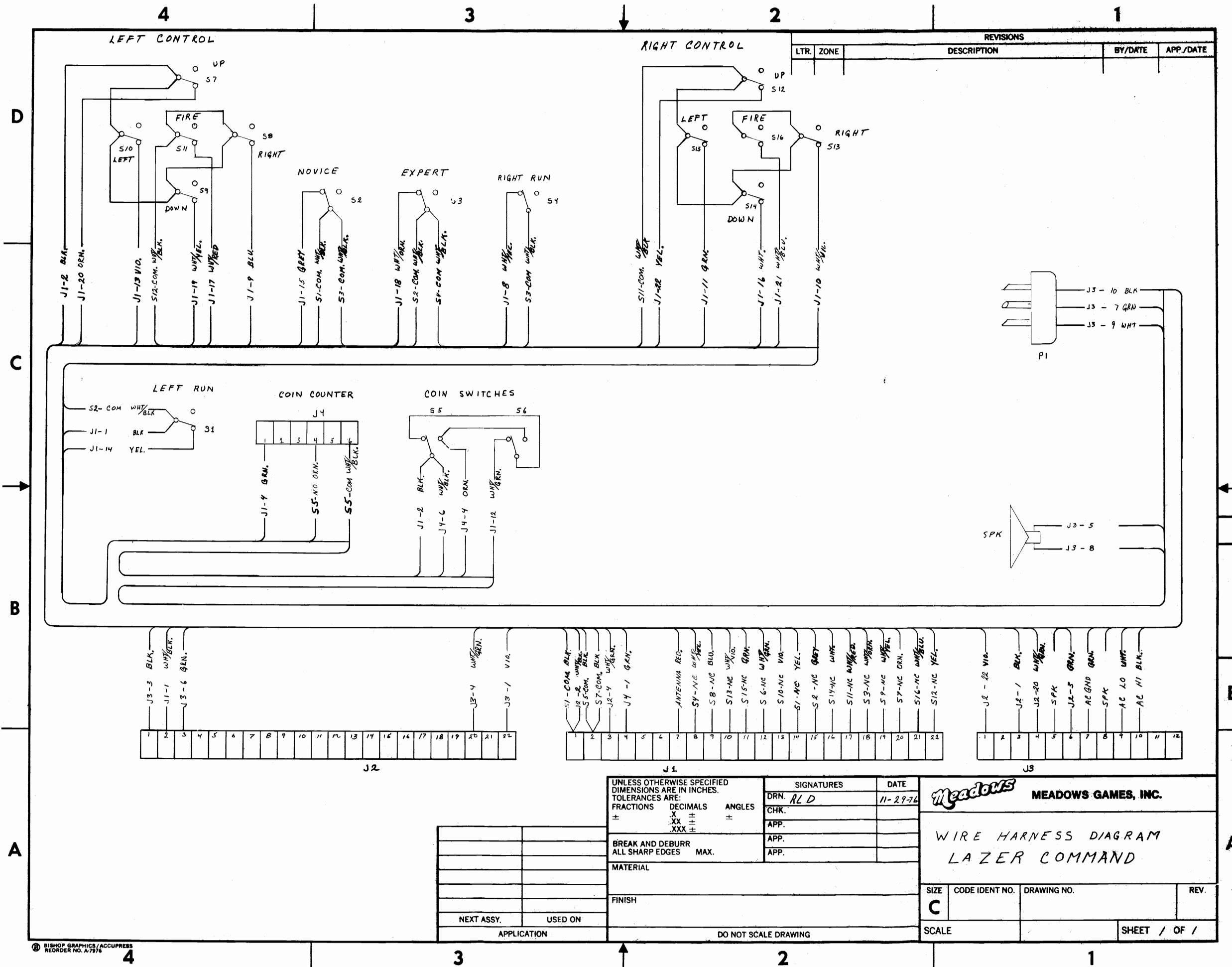

LTR. ZONE		DESCRIPTION	BY/DATE	APP./DATE

UNLESS OTHERWISE SPECIFIED DIMENSIONS ARE IN INCHES. TOLERANCES ARE:		
FRACTIONS	DECIMALS	ANGLES
±	.XX ±	±
±	.XXX ±	±

BREAK AND DEBURR ALL SHARP EDGES MAX.

MATERIAL

FINISH

NEXT ASSY. USED ON

APPLICATION DO NOT SCALE DRAWING

SIGNATURES	DATE
DRN. <i>RLD</i>	11-29-76
CHK.	
APP.	
APP.	
APP.	

Meadows MEADOWS GAMES, INC.

WIRE HARNESS DIAGRAM
LAZER COMMAND

SIZE	CODE IDENT NO.	DRAWING NO.	REV.
C			

SCALE	SHEET / OF /

REVISIONS			
LTR	DESCRIPTION	BY/DATE	APPROVED
A	REVISED PER E.C.O. 114	2/19/76	William H. [Signature]
B	REVISED PER E.C.O. 114-1		000-12-14-20

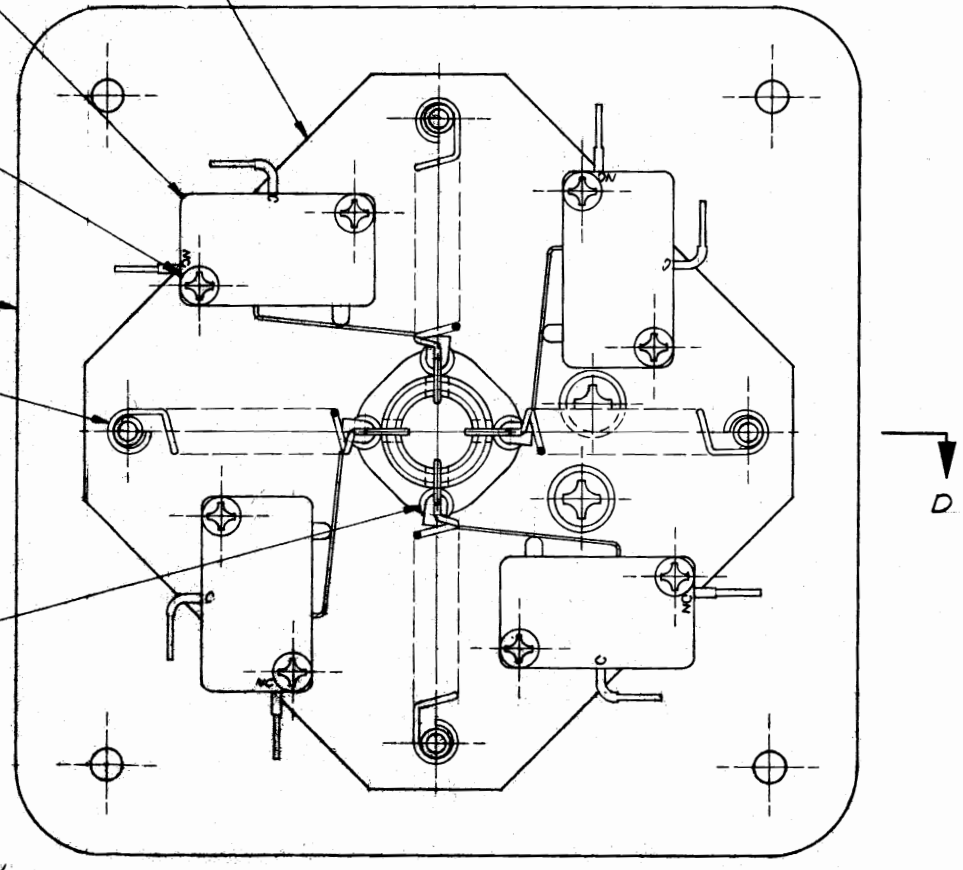
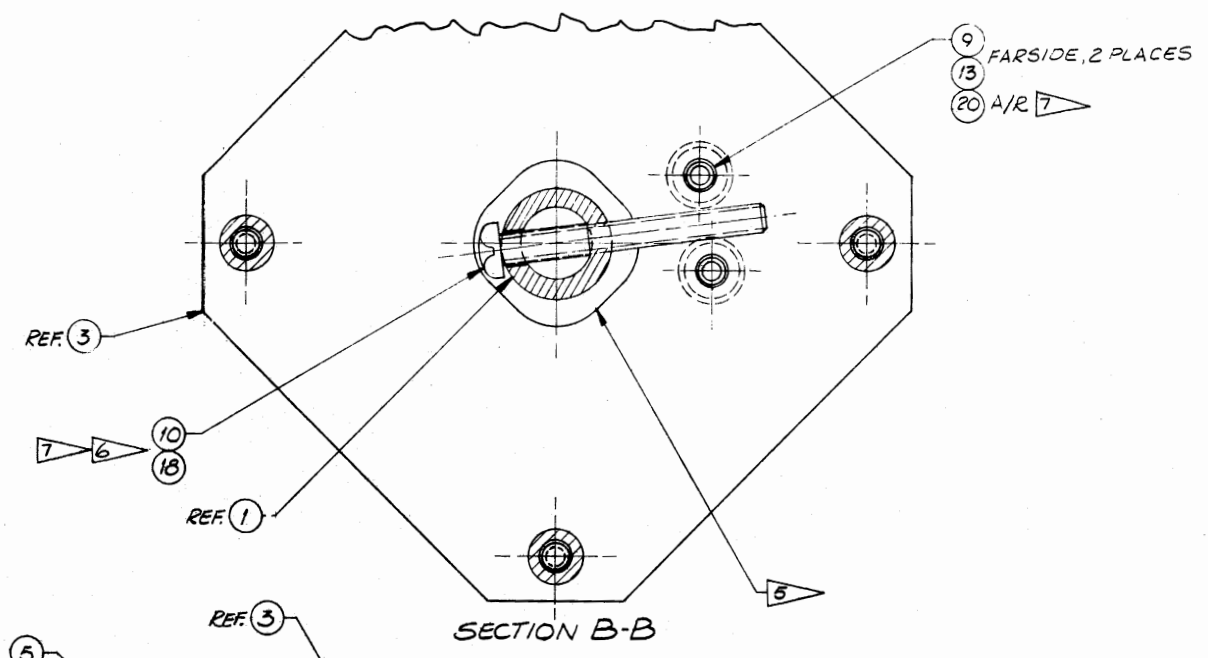
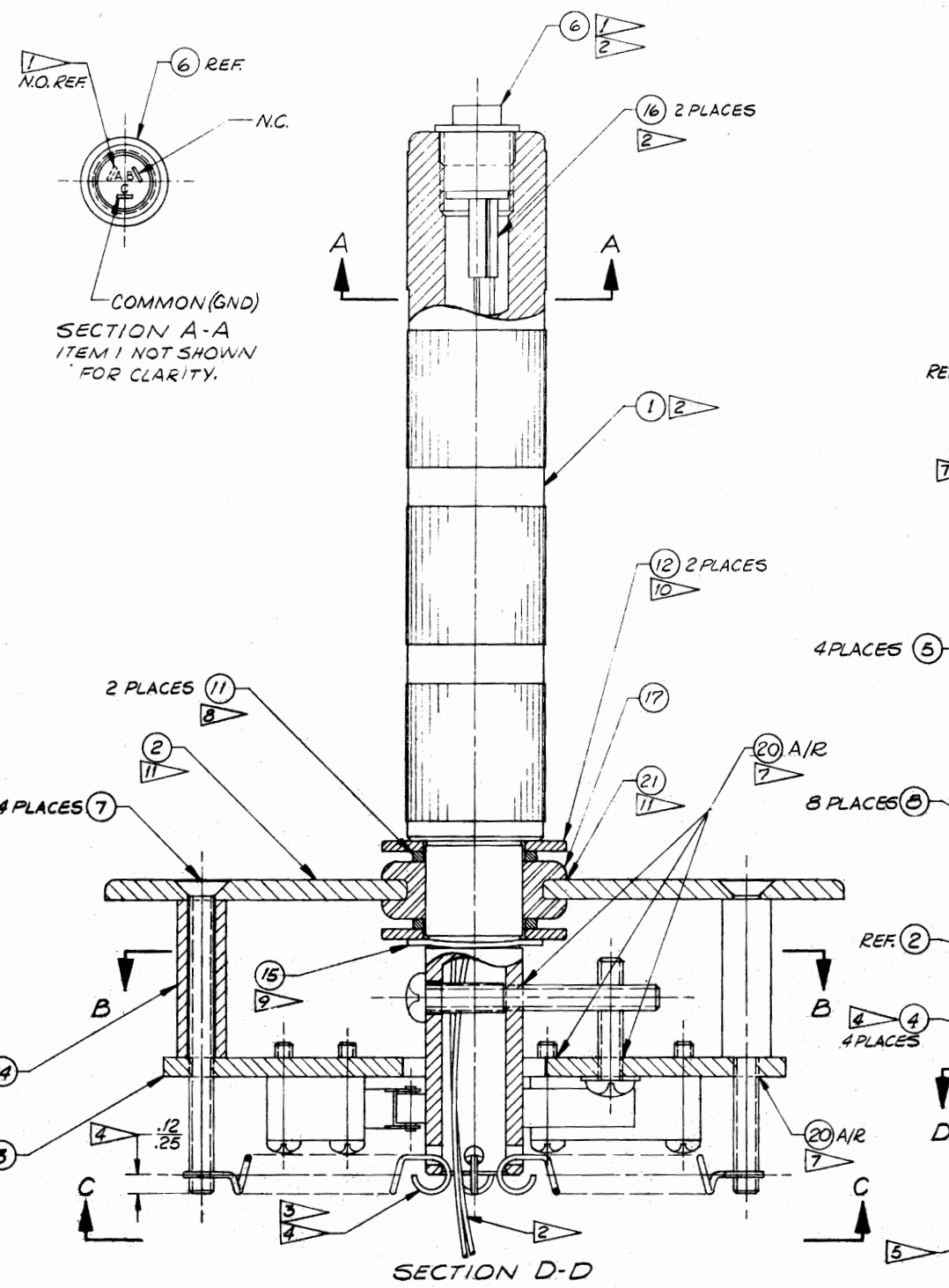

COMMON (GND)
SECTION A-A
ITEM 1 NOT SHOWN
FOR CLARITY.

NOTES:

- 1 REMOVE THE N.O. (A) CONTACT PIN FROM ITEM 6 BEFORE ASSY BY CUTTING.
- 2 FEED THE 2 WIRES FROM HARNESS 027-0025 REF. THRU. ITEM 1, INSTALL TWO ITEM 16 PIECES, CONNECT WIRES TO ITEM 6, SHRINK ITEM 16 & THREAD ITEM 6 INTO ITEM 1, TIGHTEN USING SPECIAL TOOL P/N
- 3 TRIM THE HOOKS OF THE ITEM 4 PIECES AS SHOWN. INSTALL THE ITEM 4 PIECES WITH THE HOOKS AS SHOWN & TO THE DIMENSION SHOWN.
- 4 COAT THE HOLE IN ITEM 3 & THE WHEEL OF THE ITEM 5 PIECES WITH ITEM 19, AS REQ'D.
- 6 SLIP ITEM 18 ONTO ITEM 10 & SHRINK BEFORE INSTALLING ITEM 10 INTO ITEM 1.
- 7 SEAL ALL THREAD JUNCTIONS WITH ITEM 20 AS REQ'D.
- 8 INSTALL ITEM 11 PIECES WITH THE CORNER RADIUS TOWARD ITEM 17, 2 PLACES.
- 9 INSTALL ITEM 15 WITH CURVATURE AS SHOWN.
- 10 INSTALL ITEM 12 WITH CORNER RADIUS AWAY FROM ITEM 17.
- 11 COAT ITEM 17 ALLOVER WITH ITEM 21 BEFORE INSTALLATION INTO ITEM 2. WIPE AWAY EXCESS ITEM 21 AFTER ASSEMBLY IS COMPLETED.

SEE LIST OF MATERIALS 112-0083

TOLERANCES UNLESS OTHERWISE SPECIFIED FRACTIONS DEC. ANGLES		MEADOWS GAMBER, INC. 181 COMMERCIAL ST. SUNNYVALE, CA 94086	
APPROVALS	DATE	UNIVERSAL 4-WAY CONTROL HANDLE ASSEMBLY	
012-0168	10-21-76	SCALE	2:1
NEXT ASSY	USED ON	SEE DRAWING NO.	D 012-0083 B
		DO NOT SCALE DRAWING	SHEET 1 OF 1