

MIDWAY

**MARCH 1995
16-44039-101**

MORTAL KOMBAT 3 KIT

OPERATION MANUAL

**Operation & Adjustments • Testing & Problem Diagnosis
Parts Information • Wiring Diagrams**



MORTAL KOMBAT

3

KIT

INSTRUCTIONS

Insert Coin(s).

In a two player game, the loser pays and the winner stays.

Press the Punch and Kick buttons to attack an opponent.

Press the Run button to make your on-screen character run.

Use the joystick to make the on-screen character jump, duck, move left, and move right.

Use different joystick and button combinations to discover secret moves.

MORTAL KOMBAT

3

KIT

Information current at time of release.

MIDWAY Manufacturing Company reserves the rights to make modifications and improvements to its products. The specifications and parts identified in this manual are subject to change without notice.

TABLE OF CONTENTS

Section One - Operation

Safety Notices	1-2
FCC Notice	1-3
Conversion Procedure	1-3
Inspection and Parts List.....	1-3
CPU/Sound Board Assembly.....	1-4
Converting a Typical Video Game Cabinet	1-6
Cabinet Modifications.....	1-6
Control Panel Modifications.....	1-6
Suggested Control Panel Template Layout.....	1-7
Suggested Control Panel Layout and Sticker Locations.....	1-7
Upgrading a Mortal Kombat 2 to a Mortal Kombat 3	1-8
Install the PC Board Into a JAMMA Cabinet.....	1-8
Install the PC Board Into a Non-JAMMA Cabinet.....	1-9
Game Features	1-10
Starting-up.....	1-10
Player Controls.....	1-10
Control Panel Diagram.....	1-10
Menu System Operation	1-11
Operation.....	1-11
Main Menu.....	1-11
Diagnostic Test.....	1-12
Switch Test.....	1-12
DIP Switch Table and Test.....	1-13
CPU and Sound Board Test.....	1-14
Monitor Patterns and Burn-in Test.....	1-15
Coin Bookkeeping.....	1-16
Game Audits.....	1-17
Game Adjustments.....	1-18
Standard Pricing Table.....	1-20
Custom Pricing Table.....	1-21
Utilities.....	1-22
Hardware Info.....	1-23
Volume Adjust.....	1-24
Troubleshooting	1-25

Section Two - Cabinet Wiring

JAMMA Chart.....	2-2
Interboard Wiring.....	2-3
Cabinet Wiring Diagram.....	2-4
Coin Switch and Meter Wiring.....	2-5

© Copyright 1995 MIDWAY Manufacturing Company

DYNAMO HS-5 IS A TRADEMARK OF DYNAMO CORPORATION.

**MORTAL KOMBAT
3
KIT**

**SECTION
ONE**

OPERATION

SAFETY NOTICES

The following safety instructions apply to all kit operators and service personnel. Specific warnings and cautions will be found throughout this manual where they apply. We recommend that you read this page before preparing your kit for play.



CAUTION

SALVAGED PARTS. Parts salvaged from old games are required to complete your kit. These salvaged parts must operate perfectly: otherwise, the converted game cannot perform properly or safely. Always repair circuit board malfunctions and cabinet damage before conversion is attempted.

POWER SUPPLY. Be sure the power supply from your old game is capable of +5Vdc at 5A, -5Vdc at 1A, and +12Vdc at 2A. These operating voltages are necessary for the kit. Your power supply must be FCC approved.

MONITOR. This kit is not intended for use with X-Y monitor. Suitable monitors have horizontally mounted CRTs and raster electronics with inputs for red, green, and blue video, as well as COMPOSITE NEGATIVE SYNC inputs.

COIN MECHANISMS. Be sure to clean and lubricate your old coin mechanisms. Servicing them is crucial to your game's earning potential and operation.

COIN METERS. Coin meters are not provided with this kit. Wiring information is provided as a convenience to the operator.

DISCONNECT POWER DURING INSTALLATION OR REPAIRS. To avoid electrical shock, disconnect the game from the AC power source.

!! ATTENTION !!

PROPERLY ATTACH ALL CONNECTORS. Be sure that the connectors on each printed circuit board (PCB) are properly connected. If they do not slip on easily, do not force them. A reversed connector may damage your game and void the warranty. All connectors are keyed to fit specific pins on each board.

NOTICE - FCC WARNING STICKER

- I. **THIS KIT WAS TESTED IN A MIDWAY UNIVERSAL VIDEO CABINET AND A DYNAMO HS-5 CABINET, AND FOUND TO COMPLY WITH FCC PART 15 CLASS A REQUIREMENTS.** IF INSTALLED IN A MIDWAY UNIVERSAL VIDEO CABINET, OR A DYNAMO HS-5 CABINET, THE FCC STICKER (16-9306) SUPPLIED IS TO BE PLACED ON THE REAR OF THE CABINET.
- II. **INSTALLATION OF THIS KIT INTO ANY OTHER PRODUCT DOES NOT GUARANTY COMPLIANCE WITH THE FCC REQUIREMENTS.** YOU ARE SOLELY RESPONSIBLE, AND MIDWAY WILL HAVE NO RESPONSIBILITY, FOR FCC COMPLIANCE FOR INSTALLATIONS IN OTHER PRODUCTS. THE FCC WARNING STICKER SUPPLIED SHOULD NOT BE INSTALLED ON THE CONVERTED PRODUCT UNTIL FCC COMPLIANCE IS VERIFIED.

CONVERSION PROCEDURE

INSPECTION

Unpack the materials from the carton and inspected for obvious signs of damage. Use this checklist to be sure the kit is complete.

Part Number	Item	Quantity
<input type="checkbox"/> A-18968-40039	CPU/Sound board assembly	1
<input type="checkbox"/> H-18158	main JAMMA cable	1
<input type="checkbox"/> H-19961	control panel cable	1
<input type="checkbox"/> H-20242	Speaker Extension Cable	1 (Use only when converting MK2 to MK3)
<input type="checkbox"/> 03-8338-1	1/4" PCB mounting spacers	8
<input type="checkbox"/> 16-9306	FCC Warning sticker	1
<input type="checkbox"/> 16-9922	Epilepsy Warning label	1
<input type="checkbox"/> 16-10044	Template	1
<input type="checkbox"/> 20-9687-1	red push-buttons	4
<input type="checkbox"/> 20-9687-2	white push-buttons	4
<input type="checkbox"/> 20-9687-3	blue push-buttons	4
<input type="checkbox"/> 20-9687-5	yellow push-buttons	2
<input type="checkbox"/> 20-9978-1	8-way joystick	2
<input type="checkbox"/> 31-1789	clear overlay	1
<input type="checkbox"/> 31-2315	screened overlay	1
<input type="checkbox"/> 31-2316-1	screened marquee	1
<input type="checkbox"/> 31-2319	side panel decal	2
<input type="checkbox"/> 31-2320	decal set	1
<input type="checkbox"/> 4108-01092-10B	torx head tamper resistant screws	10 (to attach clear overlay to control panel)
<input type="checkbox"/> 4308-01123-24B	8-32 x 1-1/2 bolts	8 (to attach joysticks to control panel)
<input type="checkbox"/> 4408-01128-00	8-32 nuts	8 (to attach joysticks to control panel)
<input type="checkbox"/> 4700-00090-00B	.156 x .375 x .030 flat washers	10 (to attach clear overlay to control panel)
<input type="checkbox"/> 5556-13956-00	Ferrite Bead	1
<input type="checkbox"/>	FBI label	1

DYNAMO HS-5 IS A TRADEMARK OF DYNAMO CORPORATION.

CPU/Sound Board Assembly A-18968-40039



**CPU/Sound Board Assembly
A-18968-40039**

<u>Designation</u>	<u>Part Number</u>	<u>Description</u>
B1	5880-11056-00	Battery, 3V Lithium
U57	A-20093	Sound PLD Assy
U35	A-20095	FPGA Assy
U45	A-20096	FPGA Assy
U47	A-20097	FPGA Assy
U2	A-5343-40039-02	EPROM Assy, Music/Speech
U3	A-5343-40039-03	EPROM Assy, Music/Speech
U4	A-5343-40039-04	EPROM Assy, Music/Speech
U5	A-5343-40039-05	EPROM Assy, Music/Speech
U133	A-5343-40039-06	EPROM Assy, Image
U132	A-5343-40039-07	EPROM Assy, Image
U131	A-5343-40039-08	EPROM Assy, Image
U130	A-5343-40039-09	EPROM Assy, Image
U129	A-5343-40039-10	EPROM Assy, Image
U128	A-5343-40039-11	EPROM Assy, Image
U127	A-5343-40039-12	EPROM Assy, Image
U126	A-5343-40039-13	EPROM Assy, Image
U125	A-5343-40039-14	EPROM Assy, Image
U124	A-5343-40039-15	EPROM Assy, Image
U123	A-5343-40039-16	EPROM Assy, Image
U122	A-5343-40039-17	EPROM Assy, Image
U121	A-5343-40039-18	EPROM Assy, Image
U120	A-5343-40039-19	EPROM Assy, Image
U119	A-5343-40039-20	EPROM Assy, Image
U118	A-5343-40039-21	EPROM Assy, Image
U54	A-5343-40039-22	EPROM Assy, Program
U63	A-5343-40039-23	EPROM Assy, Program
U117	A-5343-40039-24	EPROM Assy, Program
U116	A-5343-40039-25	EPROM Assy, Program
U115	A-5343-40039-26	EPROM Assy, Program
U114	A-5343-40039-27	EPROM Assy, Program
P3	5791-12461-05	Header, 5-pin
P9	5791-12461-07	Header, 7-pin
P10	5791-12461-10	Header, 10-pin
P8, P11, P12	5791-12461-15	Header, 15-pin

CONVERTING A TYPICAL VIDEO GAME CABINET

Recommended tools and supplies

- | | |
|--|--|
| <input type="checkbox"/> black semi-gloss paint | <input type="checkbox"/> black electrical tape |
| <input type="checkbox"/> electric drill | <input type="checkbox"/> surplus assorted screws |
| <input type="checkbox"/> electric screwdriver | <input type="checkbox"/> wire cutters |
| <input type="checkbox"/> grease pencil or marker | <input type="checkbox"/> soldering iron and solder |
| <input type="checkbox"/> hex driver | <input type="checkbox"/> razor knife |
| <input type="checkbox"/> 180 grit sandpaper or electric sander | |

CABINET MODIFICATIONS

1. Repaint the cabinet with black semi-gloss paint (games with wood grain sides: remove the old decal and artwork, and clean the glue residue before painting). Allow the paint to dry.
2. Pencil a line roughly at the top of the old graphic. Lightly moisten the cabinet with soapy water. Apply the decal starting at the top and working down. After the decal is in place, smooth it down, taking care to squeeze out air bubbles. If you miss an air bubble, pop it with a razor knife or a pin and burnish it down. Allow 12 hours for the adhesive in the decal to set. Remove the masking.
3. Remove the marquee from the game cabinet and install the **MORTAL KOMBAT 3** marquee in its place.
4. Place the Epilepsy Warning label on the front of the monitor bezel. Be sure that it does not obstruct the CRT screen, but is in full view of the players.

CONTROL PANEL MODIFICATIONS

1. Remove the control panel buttons and joysticks and remove the old vinyl covering and artwork.
2. Use the control panel template to help you design the control panel. Refer to page 1-7 for suggested template layout. The template is separate from the manual: part number 16-10044.
3. Drill holes, as needed, for the joysticks and the control panel buttons. Plug previous holes with wood blocks, putty, cardboard, or epoxy. File the new holes smooth. **Note: If converting from a MORTAL KOMBAT 2 cabinet, you only need to drill a hole for the Run button. There is one Run button per player for a total of two buttons. Holes for the other buttons and the joysticks are already in place.**
4. Carefully remove the backing on the vinyl control panel overlay. Place the overlay on the top of the control panel. Prevent air bubbles from getting under the overlay.
5. After the overlay is secure, use a razor knife to cut holes for the control panel buttons and joysticks.
6. Position the stickers next to the appropriate hole locations. Refer to page 1-7 for suggested control panel button and joystick locations.
7. Being careful not to displace the stickers, place the overlay on the control panel. Use the torx head tamper resistant screws and the flat washers to attach the clear overlay to the control panel. Once the clear overlay is securely in place, cut holes for the joysticks and control panel buttons.

8. Remove the switch from the push-button by pulling the large prong away from the switch, then pull the switch off of the housing. Unscrew the nut from the housing. Open the control panel. Slide the push-buttons through the control panel from the front. Screw the nut onto the switch housing from the back of the panel. Snap the switch back onto the housing.
9. To install the joysticks, first remove the "E"-ring and slide the shaft and the plastic ring off the joystick base. Be sure that the bushings remain in the base. Use the 8-32 bolts and the 8-32 nuts to attach the base to the underside of the control panel. Slide the plastic ring around the shaft so that the rough side is next to the shaft handle. Slide the shaft through the control panel and base. Replace the "E"-ring.

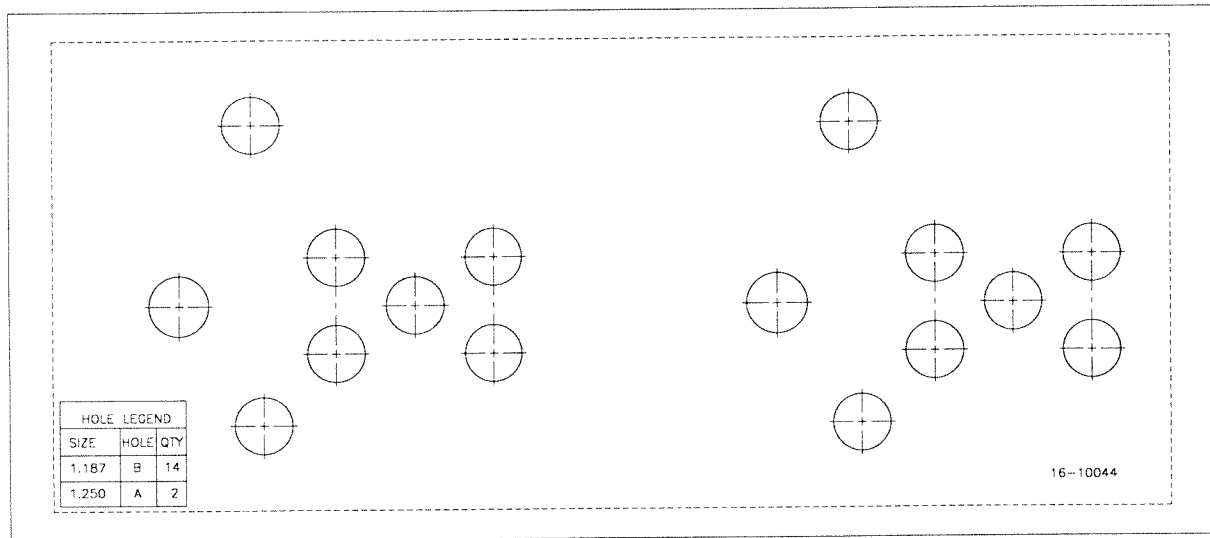

SUGGESTED CONTROL PANEL TEMPLATE LAYOUT

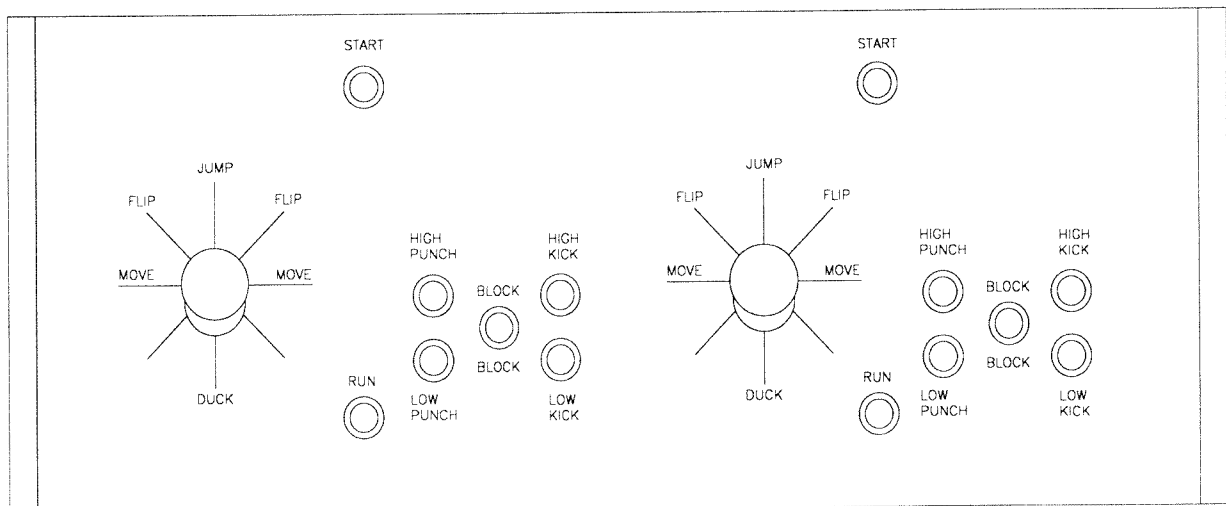

SUGGESTED CONTROL PANEL LAYOUT AND STICKER LOCATIONS FOR A TYPICAL VIDEO GAME CONTROL PANEL.

UPGRADING A MORTAL KOMBAT 2 TO A MORTAL KOMBAT 3

1. Remove the **MORTAL KOMBAT 2** CPU and Sound board. Using 1/4" spacers and surplus screws, secure the **MORTAL KOMBAT 3** CPU/Sound board to the rack.
2. Pull the JAMMA cable out of the two cable clamps on the top of the rack. This should give enough length to plug the JAMMA cable into the **MORTAL KOMBAT 3** CPU/Sound board.
3. Find the speaker break-out in the JAMMA cable. Unplug the Speaker Break-out cable from the Speaker Cabinet cable. Plug one end of the Speaker Extension cable into the Speaker Break-out cable and the other end into the Speaker Cabinet cable.
4. The only difference between the Control Panel cables on **MORTAL KOMBAT 2** and **MORTAL KOMBAT 3** is the wiring for the player 1 and player 2 Run buttons.

Locate the control panel cable connector with blue-'color stripe' wires. To connect the player 1 Run button, route a wire from the push-button switch, on the control panel, to pin 4 of the connector. For the player 2 Run button, route a wire from the push-button switch, on the control, panel to pin 9 of the connector. Extend the ground wire to the other side of both of the push-button switches.

5. If the original FBI Warning Label, for some reason, is no longer inside the cabinet, place the FBI Warning Label included in this kit next to the CPU/Sound board. Be sure the label is completely visible.

INSTALL THE PC BOARD INTO A JAMMA CABINET

1. Replace the existing CPU board and sound board with the **MORTAL KOMBAT 3** CPU/Sound board. Use the 1/4" PCB mounting spacers and surplus screws to secure the CPU/Sound board to the electronic rack, or to the inside wall of the cabinet.
2. If you choose to use the JAMMA cable provided with the kit, disconnect your old JAMMA cable from the speaker, power supply, control panel switches, (which may already be disconnected), and coin door. Remove the cable from the game. Leave your power chassis as is. **Note: If you choose to use your own JAMMA cable, check the JAMMA chart to be sure your cable is compatible.**



CAUTION

Properly insulate any unused wires within the JAMMA cable, especially gray, gray-green, and gray-yellow wires. This is a fully wired JAMMA cable. Many of the wires will not be used for this kit. These wires have been installed so that you can use this cable for future kits.

3. Connect the JAMMA cable to the CPU/Sound board. Use the Cabinet Wiring Diagram for reference and solder the correct JAMMA cable wires to the speaker. Then, connect the wires to the coin door, power supply and the control panel. Player 1 has white-'color stripe' wires, except for the Start button, which has a solid white wire. Player 2 has violet-'color stripe' wires. Use the Cabinet Wiring Diagram in section two, or the Control Panel Wire Color list on the inside back cover for reference when connecting these wires to the player 1 and 2 control panel switches.
4. Connect the Auxiliary cable to P12 of the CPU/Sound board. Use the Cabinet Wiring Diagram in section two, or the Control Panel Wire Color list on the inside back cover for reference when connecting these wires to the Low Punch and Low Kick switches.

5. Place the FBI Warning Label next to the CPU/Sound board. Be sure the label is completely visible.
6. Install the ferrite bead:
If the kit is being installed into a Dynamo HS-5 cabinet, locate the 9-pin connector at the rear of the slide out rack assembly, going to the coin door. Unplug the connector. Open the ferrite bead and loop the cable through the ferrite bead twice. Close the ferrite bead and plug the connector back in.

If the kit is being installed into a MIDWAY Universal Cabinet, locate the player 3 connector going to the CPU/Sound board. Unplug the connector from the PC board. Open the ferrite bead and loop the cable through the ferrite bead twice. Close the ferrite bead and plug the connector back in.

INSTALL THE PC BOARD INTO A NON-JAMMA GAME CABINET

1. Replace the existing CPU board and sound board with the **MORTAL KOMBAT 3** CPU/Sound board. Use the 1/4" PCB mounting spacers and surplus screws to secure the CPU/Sound board to the electronic rack, or the inside wall of the cabinet.
2. Leaving several inches of wire, cut the wires at the coin door, control panel switches, (which already may be disconnected), speaker, and power supply. Remove the harness from the cabinet. Leave your power supply chassis as is. **NOTE: Be sure that all spliced wires are well insulated with black electrical tape.**
3. Install the JAMMA cable provided with the kit. Players 1 and 2, the coin door, and the power supply wires are bundled together in individual groups. Insure that the cable is properly dressed and supported.



CAUTION

Properly insulate any unused wires within the JAMMA cable, especially gray, gray-green, and gray-yellow wires. This is a fully wired JAMMA cable. Many of the wires will not be used for this kit. These wires have been installed so that you can use this cable for future kits.

4. Connect the JAMMA cable to the CPU/Sound board. Use the Cabinet Wiring Diagram for reference and solder the correct JAMMA cable to the speaker. Then, connect the wires to the coin door, power supply and control panel. Player 1 has white-'color stripe' wires, except for Start 1 which has a solid white wire. Player 2 has violet-'color-stripe' wires. Use the Cabinet Wiring Diagram in section two, or the Control Panel Wire Color list on the back cover, for reference when connecting these wires to the player 1 and 2 control panel switches.
5. Connect auxiliary cable to P12 of the CPU/Sound board. Use the Cabinet Wiring Diagram in section two, or the Control Panel Wire Color list on the inside back cover for reference when connecting these wires to the Low Punch and Low Kick switches.
6. Place the FBI Warning Label next to the CPU/Sound board. Be sure the label is completely visible.

GAME FEATURES

STARTING UP

Switch on power to the game. A "rug" pattern appears on the screen. When the "rug" pattern ends, the screen shows *Checking Scratch RAMS*, then *Checking ROMS*. The next screen shows the revision level, the CMOS test results, and the coin setting. (Refer to page 1-4 for proper chip locations.) The game goes into the Attract Mode.

Insert the desired amount of coins, bills or tokens. Select which player receives the credit by pressing the appropriate Start button. Use the joysticks to select an on-screen character, and any control panel button to confirm your choice. Game play starts automatically once the on-screen characters are chosen.

NOTE

When an error is detected during the Start-up tests, game start-up does not progress, and an error message appears on the screen.

PLAYER CONTROLS

◆ **Start Button**

Each player has a Start button. The Start buttons allow one or two players to begin or continue play.

◆ **Joysticks**

Each player has a joystick which he uses to control an on-screen character. The player can make the on-screen character move, jump or duck.

◆ **High Kick/High Punch Buttons**

These buttons allow the on-screen character to kick or punch an opponent in the upper body.

◆ **Low Kick/Low Punch Buttons**

These buttons allow the on-screen character to kick or punch an opponent in the lower body.

◆ **Block Buttons**

These buttons allow the on-screen character to block an opponent's punch, kick, or special move.

◆ **Run Buttons**

These buttons speed up the on-screen character.

NOTE

Use joystick and button combinations to discover secret moves.

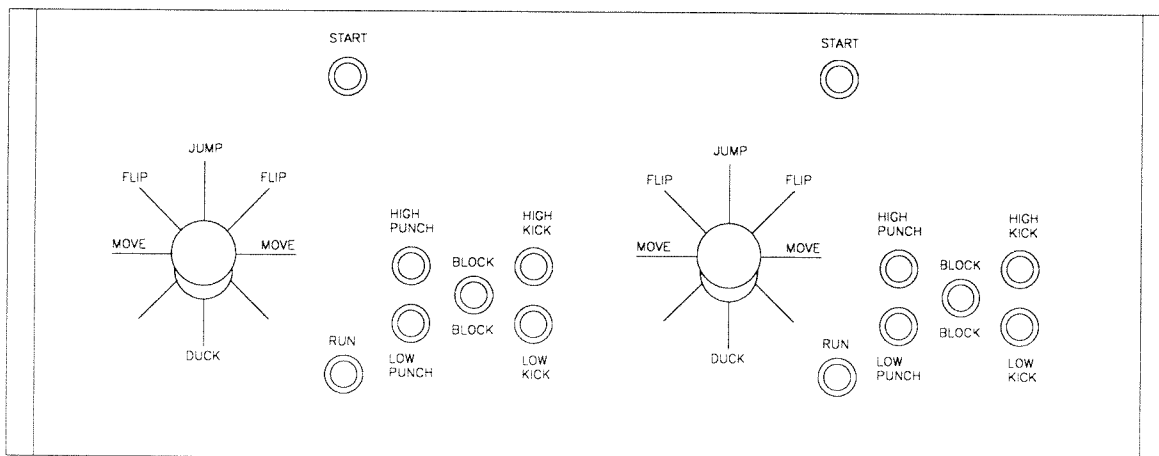

Control Panel

MENU SYSTEM OPERATION

OPERATION

All game audits, adjustments and diagnostics are options of the Main Menu. Each option, in turn, has its own menu that lists several choices which you may act upon as desired.

Press the Begin Test switch on the coin door to open the Main Menu (shown below). Game adjustments, bookkeeping and diagnostics are all accessible from this menu.

Use either joystick to move the cursor up and down the menu screen. Notice that the options are highlighted in sequence. Press any button on the control panel to open a highlighted option.

NOTE

Only highlighted options can be opened.

**SELECT WITH ANY STICK
ACTIVATE WITH ANY BUTTON**

**DIAGNOSTIC TESTS
COIN BOOKKEEPING
GAME AUDITS
GAME ADJUSTMENTS
UTILITIES
HARDWARE INFO
VOLUME ADJUST
EXIT TO GAME OVER**

MAIN MENU

To exit the Main Menu and return to the Attract Mode, use either joystick to select EXIT TO GAME OVER and press any button.

DIAGNOSTIC TESTS

Use either joystick to select the Diagnostic Menu and any button to open it. Then, use either joystick to move the cursor up and down the menu and any button to open a highlighted option.

To exit the Diagnostic Menu, use either joystick to select RETURN TO MAIN MENU and press any button.

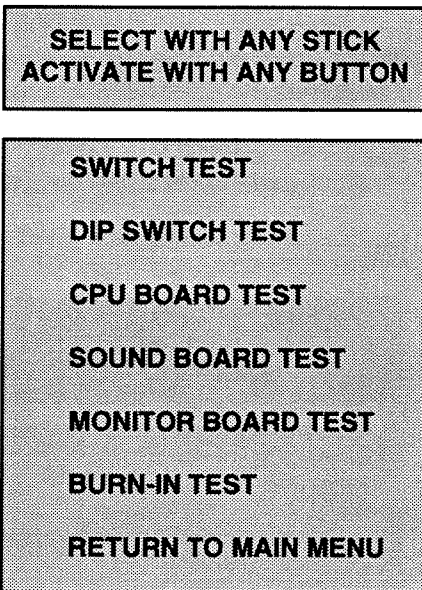

DIAGNOSTIC MENU

Switch Test

The Switch Test allows the operator to test the switches on the control panel and in the coin door.

Use either joystick to highlight the Switch Test and any button to begin the test.

During the Switch Test the top of the screen shows the control panel switches while the bottom of the screen shows the coin door switches. Press a control panel or coin door switch and the switch location on the screen lights. Release the switch and the screen returns to normal.

To exit the Switch Test, press both Start buttons together.

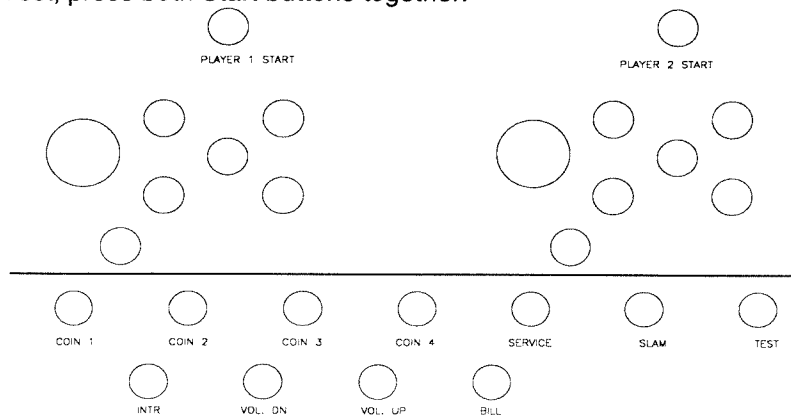

DIP Switch Test

The DIP Switch Test allows the operator to check or change the position of the DIP Switches on the CPU Board.

Use either joystick to select the DIP Switch Test. Press any button to access the DIP Switch Setting Tables. The screen displays the current settings. To change a setting, slide the switch to the desired position. Check the screen to verify the new setting. *In some cases, setting a function to OFF actually enables the function. For example, setting DIP Switch Coinage to Off enables DIP Switch Coinage.*

Press any button to return to the Diagnostic Menu.

DIP Switch 1 Setting Table

	SW. 8	SW. 7	SW. 6	SW. 5	SW. 4	SW. 3	SW. 2	SW. 1
Coinage								
DIP Switch	Off*							
CMOS	On							
Coin Settings								
USA 1 Ger. 1 Fr. 1		Off*	Off*	Off*				
USA 2 Ger. 2 Fr. 2		On	Off	Off				
USA 3 Ger. 3 Fr. 3		Off	On	Off				
USA 4 Ger. 4 Fr. 4		On	On	Off				
USA ECA Ger. ECA Fr. ECA		Off	Off	On				
N/U N/U N/U		On	Off	On				
N/U N/U N/U		Off	On	On				
Free Play Free Play Free Play		On	On	On				
Country								
USA					Off*	Off*		
Germany					On	Off		
France					Off	On		
Not Used					On	On		
1 Count/Coin Totalizer							Off*	
							On	
Test Switch								
Game Mode								Off*
Test Mode								On

DIP Switch 2 Setting Table

	SW. 8	SW. 7	SW. 6	SW. 5	SW. 4	SW. 3	SW. 2	SW. 1
Violence On	Off*							
	On							
Blood In Game		Off*						
		On						
Not Used			Off*					
			On					
Attract Sounds On				Off*				
				On				
Not Used					Off*			
					On			
Dollar Bill Validator								
Not Installed						Off*		
Installed						On		
Do Power Up Test							Off*	
Skip Power Up Test							On	
Not Used								Off*
								On

* Indicates factory setting.

CPU Board Test

The CPU Board Test, much like the Start-up Test, allows the operator to check the RAMS and the ROMS.

Select the CPU Board Test with either joystick. Press any button to start the test.

When this test is activated, a "rug" pattern appears on the screen. The screen then changes to show the layout of the RAMS and ROMS. A chip location that is shown as black with a white outline is used. A chip location that is shown as gray with a white outline is not used. During the test, chips are good if they turn green and faulty if they turn red. Turn to page 1-4 for the exact chip location.

The test pauses if a faulty RAM or ROM is detected. Press any button to continue the test.

Sound Board Test

This test allows the operator to listen to some of the sounds this game is capable of producing.

Use either joystick to select the test, then press any button to open the menu. The screen displays two test options. Use either joystick to select an option and any button to begin the test.

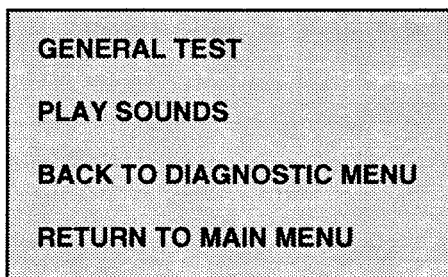

SOUND TEST MENU

GENERAL TEST analyzes the sound circuitry. The screen shows a list of error codes. A successful test causes a single "tone" to sound. Detection of a fault causes a series of tones or no tone at all to sound. Press any button to return to the Sound Test Menu.

0 TONES	-	CHECK HARDWARE
1 TONE	-	ALL O.K.
2 TONES	-	BAD U2 CHECKSUM
3 TONES	-	BAD U3 CHECKSUM
4 TONES	-	BAD U4 CHECKSUM
5 TONES	-	BAD U5 CHECKSUM
6 TONES	-	BAD U6 CHECKSUM
7 TONES	-	BAD U7 CHECKSUM
8 TONES	-	BAD U8 CHECKSUM
9 TONES	-	BAD U9 CHECKSUM
10 TONES	-	BAD U10 CHECKSUM

PLAY SOUNDS tests synthesized and digitized sounds from the CPU/Sound board. Advance to the next sound with any button. Use either joystick to end the test.

Select RETURN TO MAIN MENU or BACK TO DIAGNOSTIC MENU and press any button.

Monitor Patterns

The Monitor Patterns Test provides a menu for testing the monitor.

Select the test with either joystick. Press any button to open the test menu. Once the menu is open, use either joystick to select an option, and any button to begin it. Press any button again to return to the Monitor Patterns Menu.



MONITOR PATTERNS MENU

The **RED**, **GREEN** and **BLUE SCREEN** tests fill the screen with either red, green or blue. Press any button to return to the Monitor Patterns Menu.

The **COLOR BARS** test fills the screen with several shades of colors to help with red, green and blue level adjustments. Each color should appear sharp and clear. Press any button to return to the Monitor Patterns Menu.

The **CROSSHATCH PATTERNS** test fills the screen with a grid and a series of dots. The grid and the dots should be clear. The dots should be round. Press any button to return to the Monitor Patterns Menu.

If any of the tests show a need for adjustment, use the proper knobs on the Monitor Controls board. The Monitor Controls board is located just inside the control panel opening, beneath the monitor.

To exit this test, use either joystick to select RETURN TO MAIN MENU or BACK TO DIAGNOSTIC MENU, then press any button.

Burn-in Test

The Burn-in Test continually repeats the CPU Board Test. Use this test to find intermittent CPU Board problems. *The Audit Table specifies the number of Burn-in cycles that have been successfully completed.*

Use either joystick to select the test, then press any button to activate it. When the Burn-in Test detects an error the test stops and an error message is displayed on the screen.

To exit this test, switch the game off, then on again.

COIN BOOKKEEPING

The Coin Bookkeeping Table records the coin box totals and the game play counters.

Use either joystick to select the Coin Bookkeeping Menu, then press any button to open it.

LEFT SLOT COINS	0
RIGHT SLOT COINS	0
THIRD SLOT COINS	0
FOURTH SLOT COINS	0
BILL VALIDATOR COINS	0
SERVICE CREDITS	0
PAID CREDITS	0
TOTAL PLAYS	0
MORE DETAILED DATA RETURN TO MAIN MENU	

COIN BOOKKEEPING TABLE

LEFT SLOT COINS	0
RIGHT SLOT COINS	0
THIRD SLOT COINS	0
FOURTH SLOT COINS	0
BILL VALIDATOR COINS	0
TOTAL COLLECTIONS	0
CLEAR COIN METERS RETURN TO MAIN MENU	

TOTAL COLLECTION TABLE

To exit Coin Bookkeeping, use either joystick to select RETURN TO MAIN MENU and press any button.

GAME AUDITS

Use joystick to select the Game Audits Menu, then press any button to open it. Page through the available audits by selecting NEXT AUDIT PAGE or LAST AUDIT PAGE. Select RETURN TO MAIN MENU and press any button to exit Game Audits. *Game audits cannot be set. They can only be cleared.*

HOURS GAME WAS ON	0
HOURS PLAYED WITH 1 PLAYER	0
HOURS PLAYED WITH 2 PLAYERS	0
TOTAL PLAYS	0
1 PLAYER CONTINUES TAKEN	0
2 PLAYER CONTINUES TAKEN	0
BURN-IN LOOPS SUCCESSFULLY COMPLETED	0

NEXT AUDIT PAGE
RETURN TO MAIN MENU

PAGE 1 OF AUDIT TABLE

KANO CHOSEN	0
SONYA CHOSEN	0
JAX CHOSEN	0
NIGHTWOLF CHOSEN	0
SUB-ZERO CHOSEN	0
STRYKER CHOSEN	0
SINDEL CHOSEN	0
SEKTOR CHOSEN	0
CYRAX CHOSEN	0
KUNG LAO CHOSEN	0
KABAL CHOSEN	0
SHEEVA CHOSEN	0
SHANG TSUNG CHOSEN	0
LIU KANG CHOSEN	0
SMOKE CHOSEN	0

PREVIOUS AUDIT PAGE
RETURN TO MAIN MENU

PAGE 2 OF AUDIT TABLE

GAME ADJUSTMENTS

The Game Adjustments allow the operator to customize the game.

Use either joystick to select the Game Adjustments Menu. Press any button to open the menu.

The Game Adjustments Menu offers several options. Each option has several choices. Use either joystick to select an option, then press any button to open the option. The next menu screen provides a setting value. Use either joystick to change the setting value and press any button to lock it in.

To exit the Adjustments Menu, use either joystick to select RETURN TO MAIN MENU, and press any button.

NOTE

Adjustment values set by DIP SWITCH, override adjustment values set by the menu system.

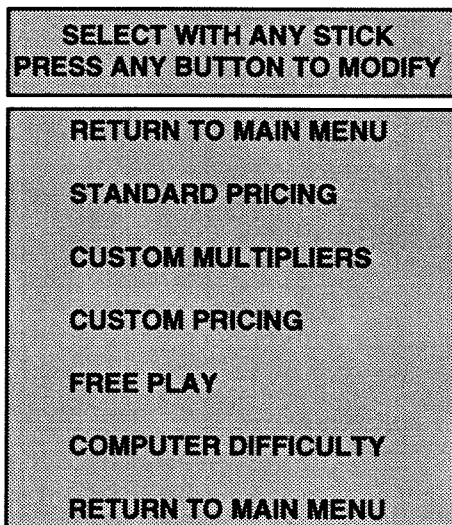

GAME ADJUSTMENT MENU

Game Adjustments

Standard Pricing

Standard pricing allow the operator to choose any of the "standard" selections from the Standard Pricing Table. See page 1-20.

Modify the setting value with either joystick. Press any button to lock in the new value and return to the Adjustments Menu.

Custom Multipliers

Customize the internal coin chute multipliers for each chute.

Custom Pricing

Custom pricing allows the operator to install pricing other than that of the Standard Pricing Table. Custom pricing also allows the operator to select the maximum amount of credits per game, the amount of credits required to start a game, and the amount of credits required to continue a game. This option is being adjusted from the DIP Switch settings. See page 1-21.

Modify the setting value with either joystick. Press any button to lock in a new value and return to the Adjustment Menu.

Game Adjustments Continued...

Free Play

This option selects free play. The setting choices for this adjustment are:

- No
- Yes
- Factory Setting: No

Computer Difficulty

This option determines how tough the computer opponents are. The setting choices for this adjustment are:

- (1) Extra Easy
- (2) Easy
- (3) Medium
- (4) Hard
- (5) Extra Hard
- Factory Setting: Medium

STANDARD PRICING TABLE

Name	Setting - Coin/Credit	Coin 1	Coin 3	Coin 2	Coin 4	Bills
USA 1	1/25¢ (2 to Start, 2 to Continue)	25¢		25¢		\$1.00
USA 2	1/25¢ (2 to Start, 1 to Continue)	25¢		25¢		\$1.00
USA 3	1/25¢ (1 to Start, 1 to Continue)	25¢		25¢		\$1.00
USA 4	1/50¢, 3/\$1.00 (1 to Start, 1 to Continue)	25¢		25¢		\$1.00
USA 5	1/50¢, 4/\$1.00 (2 to Start, 1 to Continue)	25¢		25¢		\$1.00
USA 6	1/50¢ (1 to Start, 1 to Continue)	25¢		25¢		\$1.00
USA 7	1/50¢, 3/\$1.00 (1 to Start, 1 to Continue)	25¢		25¢		\$1.00
USA 8	1/50¢, 4/\$1.00 (2 to Start, 2 to Continue)	25¢		25¢		\$1.00
USA 9	1/25¢ (3 to Start, 2 to Continue)	25¢		25¢		\$1.00
USA 10	1/25¢ (3 to Start, 3 to Continue)	25¢		25¢		\$1.00
USA ECA	1/25¢, 4/\$1.00 (2 to Start, 2 to Continue)	\$1.00	10¢	25¢	5¢	\$1.00
German 1	1/1DM, 6/5DM	1DM		5DM		
German 2	1/1DM, 7/5DM	1DM		5DM		
German 3	1/1DM, 8/5DM	1DM		5DM		
German 4	1/1DM, 5/5DM	1DM		5DM		
German 5	1/1DM, 6/5DM	1DM		5DM		
German ECA	1/1DM, 2/2DM, 6/5DM	5DM	1DM	2DM		
France 1	2/5F, 5/10F	5F		10F		
France 2	2/5F, 4/10F	5F		10F		
France 3	1/5F, 3/10F	5F		10F		
France 4	1/5F, 2/10F	5F		10F		
France 5	2/5F, 5/10F, 11/2 x 10F	5F		10F		
France 6	2/5F, 4/10F, 9/2 x 10F	5F		10F		
France 7	1/5F, 3/10F, 7/2 x 10F	5F		10F		
France 8	1/5F, 2/10F, 5/2 x 10F	5F		10F		
France 9	1/3 x 1F, 2/5F	1F		5F		
France 10	1/2 x 1F, 3/5F	1F		5F		
France 11	1/3 x 1F, 2/5F, 5/2 x 5F	1F		5F		
France 12	1/2 x 1F, 3/5F, 7/2 x 5F	1F		5F		
France ECA	1/3 x 1F, 2/5F, 5/2 x 5F	1F	10F	5F		
Canada	1/2 x 25¢, 3/\$1.00	25¢		\$1.00		\$1.00
Swiss 1	1/1F, 6/5F	1F		5F		
Swiss 2	1/1F, 7/5F	1F		5F		
Swiss 3	1/1F, 8/5F	1F		5F		
Italy	1/500 lire	500 lire		500 lire		
UK 1 ECA	1/50P, 3/£1	£1	20P	50P	10P	
UK 2 ECA	1/50P, 2/£1	£1	20P	50P	10P	
UK 3 ECA	1/30P, 2/50P, 5/£1	£1	20P	50P	10P	
UK 4	1/50P, 3/£1	£1		50P		
UK 5	1/50P, 2/£1	£1		50P		
Spain 1	1/100 peseta, 6/500 peseta	100 peseta		500 peseta		
Spain 2	1/100 peseta, 5/500 peseta	100 peseta		500 peseta		
Australia 1	1/3 x 20¢, 2/\$1.00	20¢		\$1.00		
Australia 2	1/5 x 20¢, 1/\$1.00	20¢		\$1.00		
Japan 1	1/100 yen	100 yen		100 yen		
Japan 2	2/100 yen	100 yen		100 yen		
Austria 1	1/5 schilling, 2/10 schilling	5 schilling		10 schilling		
Austria 2	1/2 x 5 schilling, 3/2 x 10 schilling	5 schilling		10 schilling		
Belgium 1	1/20F	20F		20F		
Belgium 2	3/20F	20F		20F		
Belgium 3	2/20F	20F		20F		
Belgium ECA	1/20F	50F	5F	20F		
Sweden	1/3 x 1 krona, 2/5 krona	1 krona		5 krona		
New Zealand 1	1/3 x 20¢	20¢		20¢		
New Zealand 2	1/2 x 20¢	20¢		20¢		
Netherlands	1/1 guilder, 3/2.5 guilder	1 guilder		2.5 guilder		
Finland	1/1 markka	1 markka		1 markka		
Norway	1/2 x 1 krone, 3/5 x 1 krone	1 krone		1 krone		
Denmark	1/2 x 1 krone, 3/5 krone, 7/2 x 5 krone	1 krone		5 krone		
Antilles	1/25¢, 4/1 guilder	25¢		1 guilder		
Hungary	1/2 x 10 forint, 3/2 x 20 forint	10 forint		20 forint		

CUSTOM PRICING

SELECT WITH ANY STICK PRESS ANY BUTTON TO MODIFY
RETURN TO ADJ. MENU
(1) LEFT CHUTE UNITS
(1) RIGHT CHUTE UNITS
(1) THIRD CHUTE UNITS
(1) FOURTH CHUTE UNITS
(2) DBV UNITS
(3) UNITS/CREDITS
(4) UNITS/BONUS
(5) MINIMUM UNITS REQUIRED
(6) CREDITS TO START
(7) CREDITS TO CONTINUE
(8) COINS PER DOLLAR
(9) MAXIMUM CREDIT
RETURN TO ADJ. MENU

CUSTOM PRICING MENU

- 1) Coins inserted accumulate units. This adjustment specifies the number of units given for each coin in the fourth chute (see "Units/Credit").
- 2) Coins inserted accumulate units. This adjustment specifies the number of units given for each bill validated (see "Units/Credits").
- 3) This is the number of coin units required to buy one credit.
- 4) There is one bonus credit awarded after this many coin units have accumulated.
- 5) This is the minimum number of units required before any credits are awarded.
- 6) Each player needs this many credits to begin a game.
- 7) Each player needs this many credits to continue a game.
- 8) The detailed bookkeeping screen shows total collection based on this many coins per dollar. (Set to zero to disable the display of money totals.)
- 9) This is the limit for the credit counter. Additional coins inserted will be lost (factory setting: 30).

UTILITIES

The Utilities Menu allows the operator to clear the game's bookkeeping memory.

Use either joystick to select the Utilities Menu, then press any button.

Use either joystick to select a utility. Press any button to activate the selection.

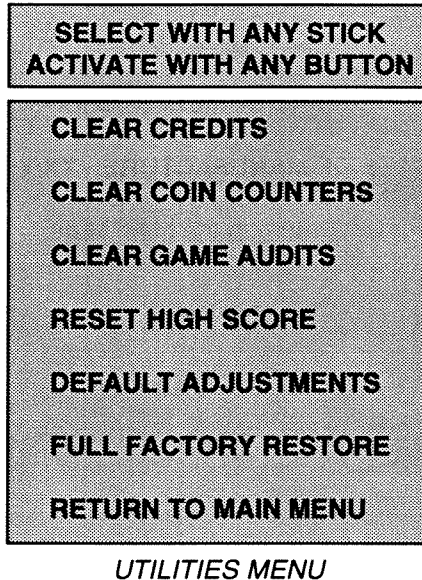

Once the selection is made, a dialogue box appears, and the operator can choose to reset the utility.

For example:

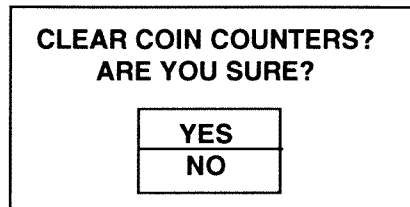

Use either joystick to choose a setting value. Press any button to lock in the new setting value.

To exit the Utilities Menu, use either joystick to select RETURN TO MAIN MENU, then press any button.

HARDWARE INFO

The Hardware Information screen gives the date the game was manufactured and the game's serial number.

**HARDWARE INFO
MIDWAY MANUFACTURING COMPANY**

WOLF UNIT

SERIAL NUMBER: XXXXXXXX

DATE OF MANUFACTURE: XX/XX/XXXX

Press any button to exit this screen and return to the Main Menu.

VOLUME ADJUST

The Volume Adjust feature allows the operator to determine the sound and music level of the game.

The volume level can be adjusted from either the Attract Mode or the Menu System. Press the Volume Up button to raise the volume level and the Volume Down button to lower the volume level. Either joystick can also be used to raise or low the volume level. The current volume level is shown with a red bar.

Press any button to return to the Main Menu.

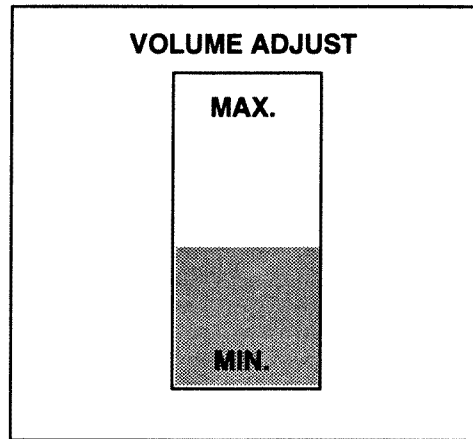

TROUBLESHOOTING

PROBLEM

- 1) No picture or distorted picture.
- 2) Turn game On and nothing happens.
- 3) No sound.
- 4) No general illumination.
- 5) Press Start button and nothing happens.
- 6) No credit given for number of coins inserted.
- 7) Too many credits for number of coins inserted.
- 8) Game stays in test mode.

POSSIBLE SOLUTION

- 1) Check for faulty video board or monitor.
Check for disconnected video signal cable.
- 2) Check line fuse. Check for +5Vdc at pins C, D, 3 and 4 of the JAMMA connector.
- 3) Check the speaker and the speaker connection to pin L and 10 on the JAMMA connector. Check volume control setting. Check for +12Vdc at pins F and 6 on the JAMMA connector. Check for -5Vdc at pins E and 5 on the JAMMA connector.
- 4) Check the 1A, S.B. fuse in the AC power pack assembly.
- 5) Check for open wires between the button and the CPU board. Check for contamination on CPU board pins or the Start button switch blade contacts. Check for proper ground.
- 6) Check DIP switch coin settings. Check for contamination on the coin switch contacts. Check for an open wire between Coin Switch 1 and pin 16 on the JAMMA connector or Coin Switch 2 and pin T of the JAMMA connector.
- 7) Check the game pricing settings. Check for a short between pins T & 16 on the JAMMA connector.
- 8) Check that the switch #8 of DIP switch bank #2 is set to off.

MORTAL KOMBAT 3 KIT

**SECTION
TWO**

CABINET WIRING

**NOTE
PRINTED CIRCUIT BOARD ASSEMBLY SCHEMATICS ARE NO LONGER AVAILABLE.**

JAMMA Chart

FUNCTION	WIRE COLOR	PIN	PIN	WIRE COLOR	FUNCTION
Ground	Black	A	1	Black	Ground
Ground	Black	B	2	Black	Ground
+5VDC	Red	C	3	Red	+5VDC
+5VDC	Red	D	4	Red	+5VDC
-5VDC	Yellow	E	5	Yellow	-5VDC
+12VDC	Orange	F	6	Orange	+12VDC
	Key	H	7	Key	
Coin Counter 2	Brown-Red	J	8	Brown	Coin Counter 1
	N/C	K	9	N/C	
Speaker-	Brown-Gray	L	10	Red-Gray	Speaker +
	N/C	M	11	N/C	
Video Green	Green	N	12	Red	Video Red
Video Sync	White	P	13	Brown	Video Blue
Service Credits	White-Gray	R	14	shield	Video Ground
Slam Tilt	Black-Green	S	15	Black-Blue	Test
Coin 2	Black-Red	T	16	Black-Brown	Coin 1
2 Start	Violet-White	U	17	White	1 Start
2 Up	Violet-Black	V	18	White-Black	1 Up
2 Down	Violet-Brown	W	19	White-Brown	1 Down
2 Left	Violet-Red	X	20	White-Red	1 Left
2 Right	Violet-Orange	Y	21	White-Orange	1 Right
2 High Punch	Violet-Yellow	Z	22	White-Yellow	1 High Punch
2 Block	Violet-Green	a	23	White-Green	1 Block
2 High Kick	Violet-Blue	b	24	White-Blue	1 High Kick
Not Used	Violet	c	25	White-Violet	Not Used
	N/C	d	26	N/C	
	N/C	e	27	N/C	
Ground	Black	f	28	Black	Ground
SOLDER SIDE			COMPONENT SIDE		

INTERBOARD WIRING

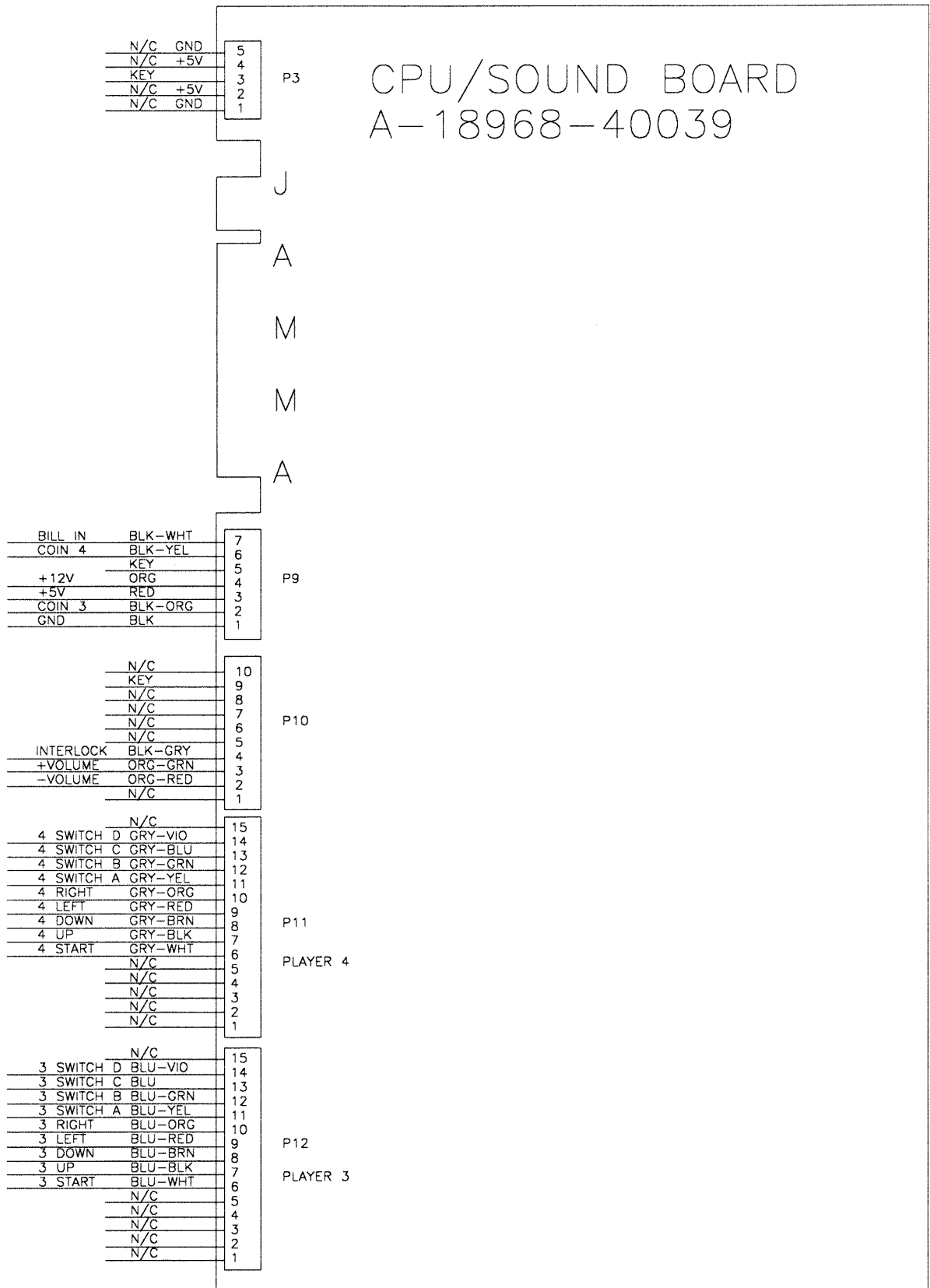

CABINET WIRING DIAGRAM

SOME STYLE MONITORS REQUIRE A DIFFERENT PINOUT FOR THE SYNC

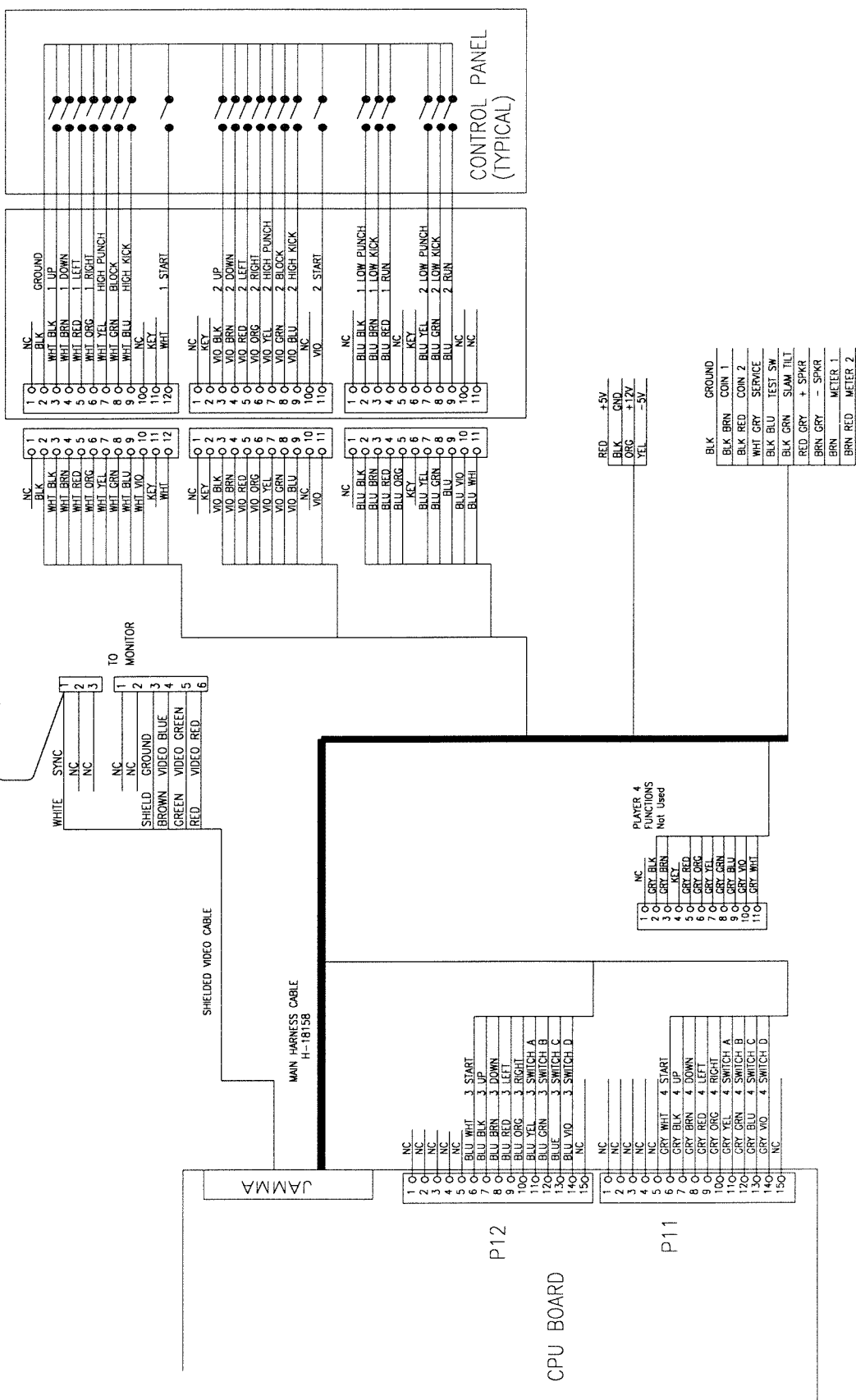

KIT CONTROL PANEL CABLE. H-19961

CONTROL PANEL (TYPICAL)

COIN SWITCH AND METER WIRING

OPTION 1

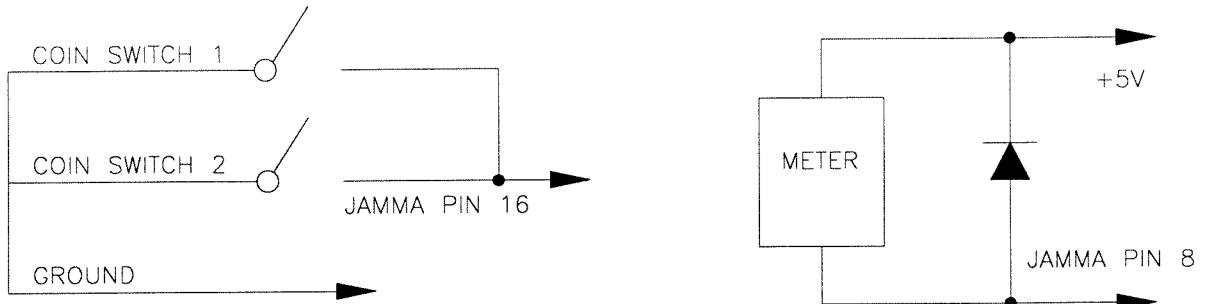

OPTION 2

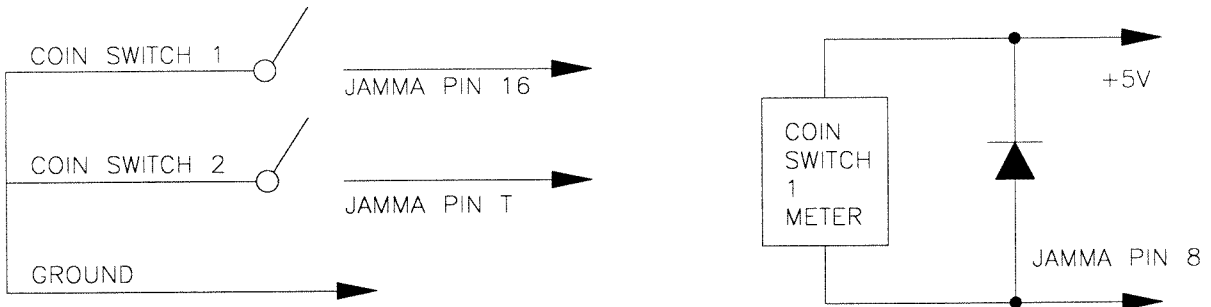

!! WRONG WAY !!

Do not connect the coin switches in this manner. This circuit is INCORRECT, and will cause twice as many credits per coin.

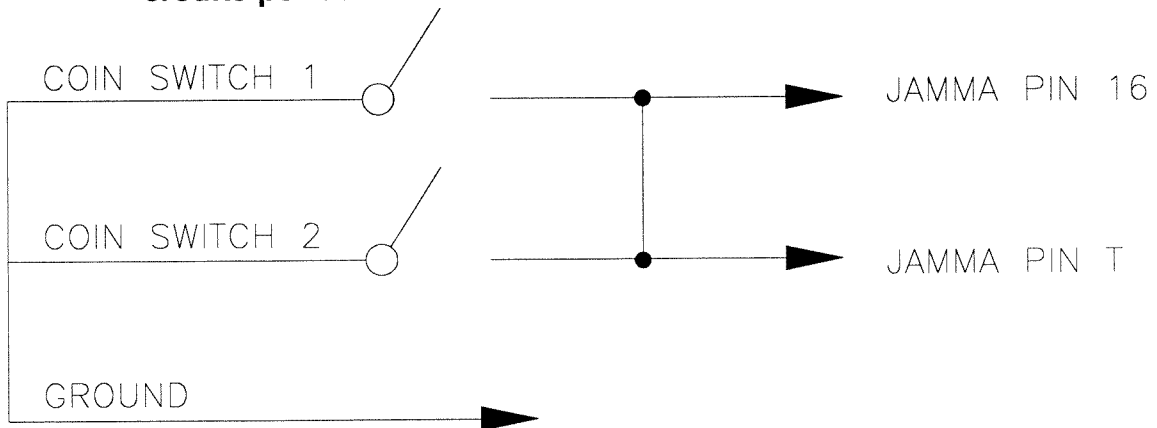

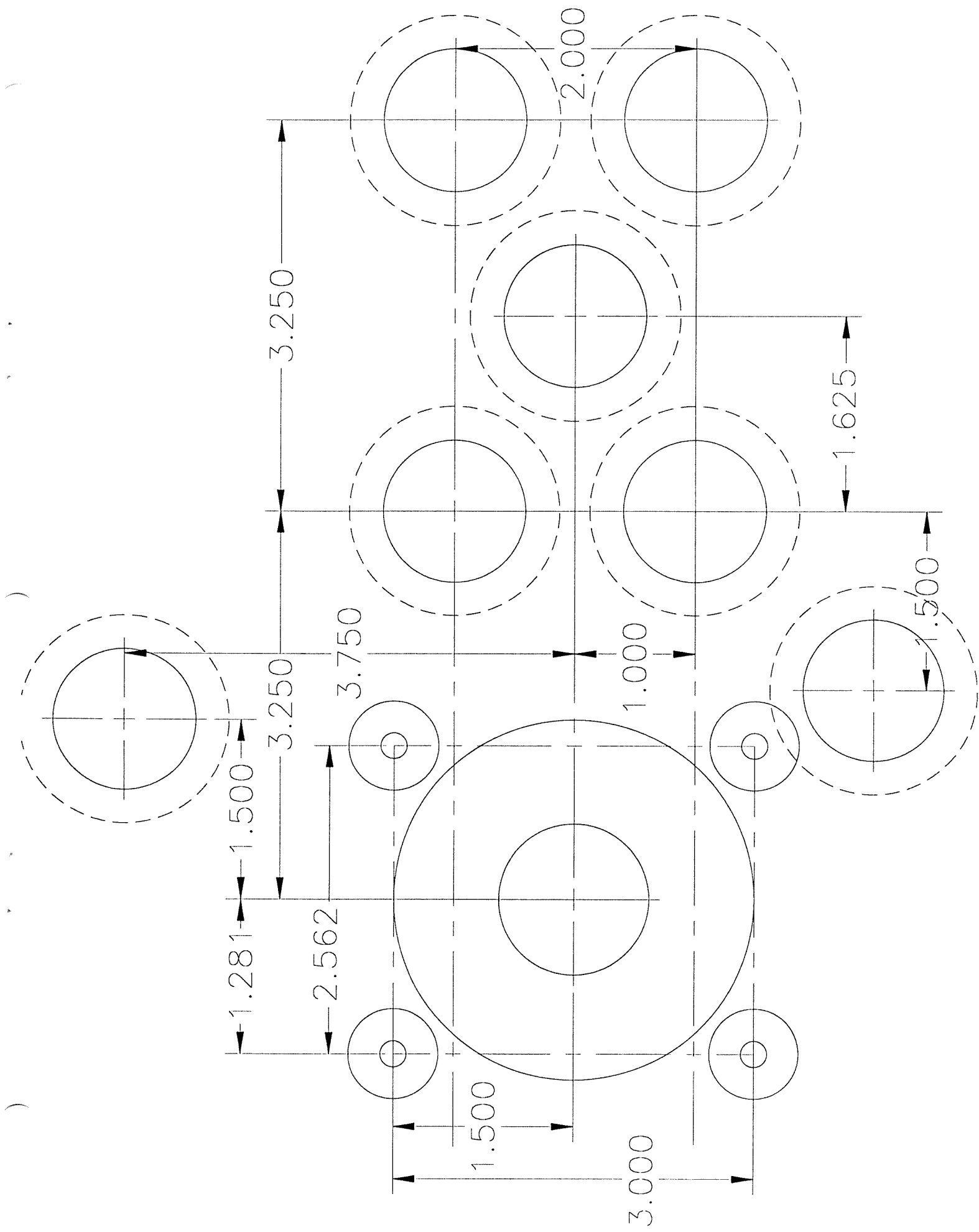

)

• • •

)

• • •

)

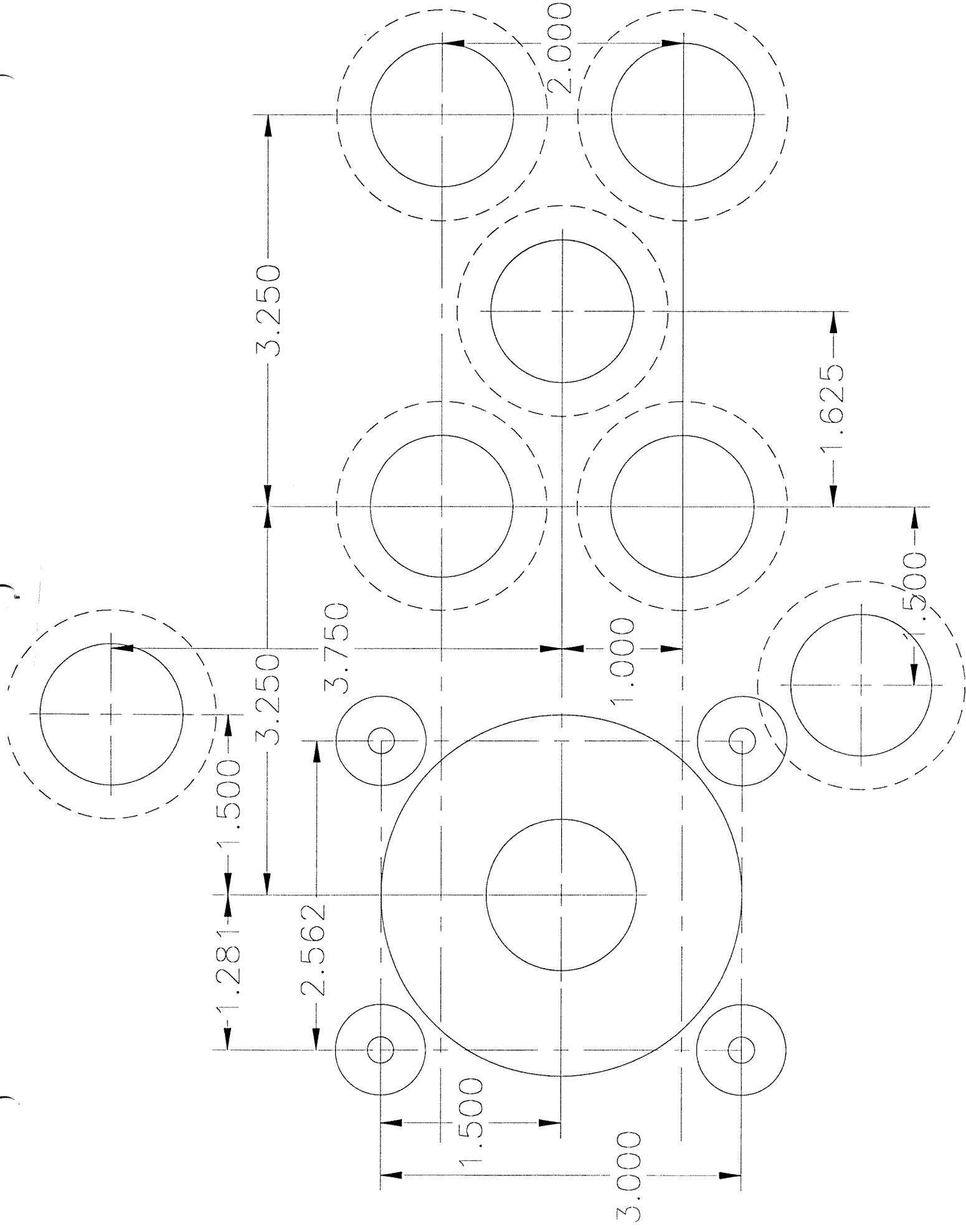

Control Panel Wire Color List

<u>PLAYER ONE</u>		<u>PLAYER TWO</u>	
<u>FUNCTION</u>	<u>WIRE COLOR</u>	<u>FUNCTION</u>	<u>WIRE COLOR</u>
Start	White	Start	Violet-White
Up	White-Black	Up	Violet-Black
Down	White-Brown	Down	Violet-Brown
Left	White-Red	Left	Violet-Red
Right	White-Orange	Right	Violet-Orange
High Punch	White-Yellow	High Punch	Violet-Yellow
Block	White-Green	Block	Violet-Green
High Kick	White-Blue	High Kick	Violet-Blue
Low Punch	Blue-Black	Low Punch	Blue-Yellow
Low Kick	Blue-Brown	Low Kick	Blue-Green
Run (Speed)	Blue-Red	Run (Speed)	Blue

WARNINGS & NOTICES

WARNING

USE OF NON-MIDWAY PARTS OR CIRCUIT MODIFICATIONS MAY CAUSE SERIOUS INJURY OR EQUIPMENT DAMAGE! USE ONLY MIDWAY AUTHORIZED PARTS.

* For safety and reliability, substitute parts and modifications are not recommended.

* Substitute parts or modifications may void FCC type acceptance.

* This game is protected by federal copyright, trademark and patent laws. Unauthorized modifications may be illegal under federal law. This also applies to MIDWAY logos, designs, publications and assemblies. Moreover, facsimiles of MIDWAY equipment (or any feature thereof) may be illegal under federal law, regardless of whether or not such facsimiles are manufactured with MIDWAY components.

WARNING

NOTE: This equipment has been tested and found to comply with the limits for a Class A digital device, pursuant to Part 15 of the FCC Rules. These limits are designed to provide reasonable protection against harmful interference when the equipment is operated in a commercial environment. This equipment generated, uses and can radiate radio frequency energy and if not installed and used in accordance with the instruction manual, may cause harmful interference to radio communications. Operation of this equipment in a residential area is likely to cause harmful interference in which case the user will be required to correct the interference at his own expense.

NOTICE - FCC WARNING STICKER

- I. **THIS KIT WAS TESTED IN A MIDWAY UNIVERSAL VIDEO CABINET AND A DYNAMO HS-5 CABINET, AND FOUND TO COMPLY WITH FCC PART 15 CLASS A REQUIREMENTS.** IF INSTALLED IN A MIDWAY UNIVERSAL VIDEO CABINET, OR A DYNAMO HS-5 CABINET, THE FCC STICKER (16-9306) SUPPLIED IS TO BE PLACED ON THE REAR OF THE CABINET.
- II. **INSTALLATION OF THIS KIT INTO ANY OTHER PRODUCT DOES NOT GUARANTY COMPLIANCE WITH THE FCC REQUIREMENTS.** YOU ARE SOLELY RESPONSIBLE, AND MIDWAY WILL HAVE NO RESPONSIBILITY, FOR FCC COMPLIANCE FOR INSTALLATIONS IN OTHER PRODUCTS. THE FCC WARNING STICKER SUPPLIED SHOULD NOT BE INSTALLED ON THE CONVERTED PRODUCT UNTIL FCC COMPLIANCE IS VERIFIED

WARNING

Prevent shock hazard and assure proper game operation. Only plug this game into a properly grounded outlet. Do not use a cheater plug to defeat the power cord's grounding pin. Do not cut off the ground pin.

NOTICE

No part of this publication may be reproduced by any mechanical, photographic, or electronic process, or in the form of a phonographic recording, nor may be transmitted, or otherwise copied for public or private use, without permission from the publisher.

Entire contents of this manual copyright © 1995 MIDWAY Manufacturing Company, INC. All Rights Reserved.

DYNAMO HS-5 IS A TRADEMARK OF DYNAMO CORPORATION.

FOR SERVICE: CALL YOUR AUTHORIZED MIDWAY DISTRIBUTOR.

**MIDWAY MANUFACTURING COMPANY
3401 N. CALIFORNIA AVE.
CHICAGO, IL 60618**