

August 1990
16-4004-K-101

PIGSKIN

-Q1A-

KIT



OPERATIONS MANUAL

including:

- Installation & Operation*
- Game Testing & Problem Diagnosis*
- Parts Information*
- Reference Diagrams & Schematics*

MIDWAY MANUFACTURING COMPANY
3401 N. California Avenue
Chicago, IL 60618

PIGSKIN
SIX-TWENTY-ONE A.D.
(Ancient Arch Rivals on a Rampage!)

The rigors of day to day existence in the early part of the Seventh Century A.D. were far more severe than those most of us face today. It is no surprise then, that the era produced "Role Models" of a slightly different sort.

Men like: Attila DeSoiled; whose infamous "Mongrel Horde" spent much of their free time sweeping across Central Asia into the dustbins of Eastern Europe.

Men like: Thor Akenbak; the renegade Viking whose piercing battle cry "... Loot and pillage, loot and pillage, Let's go find us an English Village..."

In the Dark Ages, the world's wildest warriors had a word for "mind blowing, bone crunching, heart-stopping" excitement.....PIGSKIN!

PIGSKIN 621 A.D. is a thoroughly researched, unflinchingly faithful re-creation of those exciting, fictitious days of yore when "Good, Clean Fun" was simply known as "Fun".

Each player directly controls one of a half-dozen hulking barbarians in a bone-crushing "battle for the ball" across a medieval countryside.

The object of the game: to inflict as much pain and suffering as possible on the opposition and carry the PIGSKIN back to your "stronghold" (your ship or castle) more times than your opponent can and thereby win the battle!

PIGSKIN RULES

Each player directly controls an armoured "team captain"; and indirectly controls up to 5 teammates. Each player has the following to control the character selected:

- 1 49 Way Joystick
 - 2 Punch Button(s) (whichever is more comfortable)
 - 1 Pass Button
 - 1 Team Attitude Adjustment Button
- Punch buttons allow a player to throw punches (all teammates throw punches when pressed). It can also be used along with the pass button while on defense (press both buttons to attempt a flying tackle).

The Pass button allows the player to pass or kick the ball to a teammate (passplays are shown on the screen and the player has the choice of which one to select).

Team Attitude Adjustment Buttons are used to select a style of play (get the ball, man to man, bad attitude, etc.).

Players may pick up "concealed weapons" by simply running over them. Weapons are used automatically during "grapples" involving the Pigskin. Characters that are severely injured by weapons are revived after the next goal is scored.

A "grapple" is a savage battle for the pigskin, which is usually won by the team with the most players involved in it.

The terrain will affect a character's movement (Mud, rocks, swampy areas, etc.). Players that remember how a field is "mapped out" may learn to use the terrain to their advantage.

Players score points for carrying the Pigskin (1 point for every 5 seconds in the player's possession), and for scoring a goal (6 points).

IMPORTANT NOTICE

To Receive A Free Player's Handbook Including:

- Rules
- Designer's Notes
- Strategies
- Pigskin Product Information
- Game Tips

Send a Self Addressed Stamped Envelope to:

PIGSKIN
P.O. BOX 1000
PLANO, IL 60545

PIGSKIN

G2

Table of Contents

Section 1: Kit Installation, Operation & Troubleshooting

Safety	1-2
Conversion Instructions	
Inspection.....	1-3
Recommended Tools.....	1-3
Cabinet Modifications.....	1-4
Control Panel Modifications.....	1-4
Typical Control Panel Layout.....	1-4
Installing PC Boards into a JAMMA Game Cabinet.....	1-6
Installing PC Boards into a NON-JAMMA Game Cabinet.....	1-7
Installing the Volume Control.....	1-8
Game Features	
Starting-up.....	1-9
Player Controls.....	1-9
Game Operation	
Control Switches.....	1-10
Game Adjustments and Diagnostics	
Starting-up.....	1-11
Self-test.....	1-12
Switches.....	1-12
Grid.....	1-12
DIP Switch.....	1-12
Reset High Score.....	1-12
DIP Switch Table.....	1-13
Troubleshooting	1-14

Section 2: Parts Information

CPU Board Layout.....	2-2
CPU Board Parts List.....	2-3
49-way Joystick Assembly.....	2-4
49-way Joystick Opto Board Layout and Parts List.....	2-5
Audio Board Layout and Parts List.....	2-6

Section 3: Diagrams & Schematics

JAMMA Chart.....	3-2
Audio Board Schematic.....	3-3
49-way Joystick Opto Board Schematic.....	3-4
CPU Schematic.....	3-5
Interboard Wiring.....	3-17
Wiring Diagram.....	3-18
Coin Switch & Meter Wiring.....	3-20
Control Panel Template Diagram.....	3-21

PIGSKIN

Game Operation & Troubleshooting Information

S
E
C
T
I
O
N

O
N
E

Safety Notices

The following safety hints apply to all kit operators and service personnel. Specific warnings and cautions will be found throughout this manual where they apply. We recommend that you read this page, and also all of Section 1, before preparing your kit for play.

NOTICE: SALVAGED PARTS

Parts salvaged from old games are required to complete your kit. These salvaged parts must operate perfectly; otherwise, the converted game cannot perform properly or safely. Always repair circuit board malfunctions and cabinet damage before conversion is attempted.

NOTICE: POWER SUPPLY

Be sure the power supply from your old game is capable of +5V dc at 5A, -5V dc at 1A and +12V at 1A. These operating voltages are necessary for your kit. Your power supply must be FCC approved.

NOTICE: MONITOR

This kit is not intended for use with X-Y monitors. Suitable monitors have horizontally mounted CRTs and raster electronics with inputs for red, green and blue video, as well as separate horizontal and vertical Negative Sync Inputs.

NOTICE: COIN MECHANISM

Be sure to clean and lubricate your old coin mechanisms. Servicing them is crucial to your game's earning potential and operation.

NOTICE: COIN METERS

Coin meters are not provided with this kit. Wiring Information is provided as a convenience to the operator.

NOTICE: SERVICING, INSTALLING

Always turn your game OFF and unplug it before attempting to service or install your kit.

CAUTION

PROPERLY ATTACH ALL CONNECTORS. Be sure that the connectors on each printed circuit board (PCB) are properly connected. If they do not slip on easily, do not force them. A reversed connector may damage your kit and void the warranty. All connectors are keyed to fit specific pins on each board.

Conversion Procedure

Inspection

Unpack the materials from the carton and inspect for obvious signs of damage. Use this checklist to be sure your kit is complete.

Part No.	Item	Quantity
() A-8550-1	Pot & Bracket Assembly	1
() C-13246-4004-K	68K Mini CPU Board	1
() C-13581-1	49-way Joystick Assy	2
() C-9214-4	Button Assy Red	2
() C-9214-5	Button Assy White	2
() C-9214-6	Button Assy Yellow	4
() D-11581-4004	Audio Board	1
() H-8865	Volumn Control Cable	1
() H-12746-1	Video Signal Cable	1
() H-12758	Audio Board Jumper Cable	2
() H-13257	Sound Pwr/ Spker Cable	1
() H-13411	JAMMA Cable	1
() H-14023	Players 1 & 2 Cable	1
() 03-8250	Control Panel Cover	1
() 16-4004-K-101	Manual	1
() 16-9155	Controls Template	1
() 20-9457	Button Holder w/Switch	8
() 13-1480-4004-K	Marquee	1
() 31-1481-4004-K	Control Panel Overlay	1
() 31-1482-4004-K	Decals	2
() 5795-10703-24	Ribbon Cable	1
() Assorted Hardware		

Recommended Tools and Supplies

- () black semi-gloss paint
- () electric drill
- () electric screwdriver
- () grease pencil or marker
- () hex driver
- () 180 grit sandpaper or electric sander
- () pliers
- () razor knife
- () soldering iron and solder
- () wire cutters
- () black electrical tape
- () quick-hardening wood putty

Cabinet Modifications

1. Fill in gouges with a good quick-hardening wood putty. Sand cabinet and wipe it clean.
2. Repaint the cabinet with black semi-gloss paint (Games wood grain sides: remove the old decals and clean the glue residue from the old decal before painting). Allow paint to dry completely.
3. Pencil a line roughly at the top of the old graphic. Lightly moisten the cabinet with soapy water. Apply the decal starting at the top and working down. After the decal is in place, use a piece of the foam packaging as a squeegee and smooth the decal down, taking care to squeeze out the air bubbles. If you miss an air bubble, pop it with a razor blade or a pin and burnish it down. Allow 12 hours for the adhesive in the decals to set. Remove masking.
4. Check the PIGSKIN Kit for an FCC sticker and apply it over the existing sticker on the cabinet. When Midway ships a game, it is in compliance with FCC regulations. Your sticker is proof. If the sticker is missing or damaged, legal repercussions to the owner or distributor of the game may result. If your game kit does not contain an FCC sticker, call Midway Manufacturing immediately.
5. Apply the Instructions (Card or Decals) to the CRT viewing glass.

Control Panel Modifications

1. Remove the control panel buttons and joysticks and remove the old vinyl covering.
2. Place the template on the control panel and use it to help you design your control panel. You will need to use the Mounting Template twice, once for the left side and once for the right side of the control panel.

TYPICAL CONTROL PANEL LAYOUT

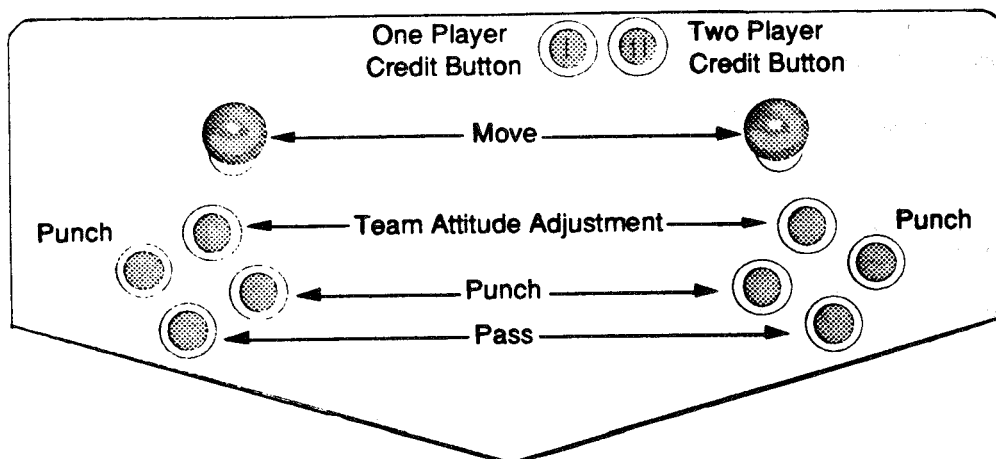

3. Drill holes as needed for the joysticks and buttons. Plug previous holes with wood blocks, putty, cardboard or epoxy. File the new holes smooth.
4. Carefully remove the backing on the vinyl control panel overlay. Place the overlay on top of the control panel. Prevent air bubbles from getting under the vinyl overlay.
5. a) After the overlay is on securely, use a razor knife to cut holes for the buttons and joysticks.
b) Position the stickers around the appropriate button locations. Refer to the Typical Control Panel Layout diagram on the previous page for suggested button and joystick locations.
c) Peel the backing from the adhesive on the clear protective overlay. Position the overlay so that it covers the stickers and press it into place. Use a razor knife to cut holes for the joystick and buttons.
6. To mount the pushbuttons and button-holder/switch to the control panel, push the threaded end of the pushbutton through the control panel from the top so that the threads extend through the back of the control panel. Then, take the white plastic button holder/switch and place it over the pushbutton threads so that the threads extend through the hole in the holder. The blade switch must point toward the back of the cabinet and face you. Secure into place with a pinnut. Repeat for all of the pushbutton switches.
7. The joystick must be disassembled before mounting it to the control panel. Remove the 4 screws from the back of the slide assembly. Remove the slide assembly, the PC Board, and the stop assembly. Take off the "E" ring and the white plastic spacer. Slide the knob out of the base. Mount the base to the back of the control panel. Insert the knob through the base from the front of the control panel. Replace the white plastic spacer and the "E" ring. Slip the stop assembly over the knob shaft so the legs fit into the base (do not force). Replace the PC Board component side facing you; **BE SURE THAT THE CONNECTOR FACES THE RIGHT SIDE OF THE CONTROL PANEL.** Install the slide assembly so that the holes in both slides fit over the knob shaft and replace the 4 screws.

Note

If the PC Board connector must face the top of the control panel then, set DIP Switch 8 to On.

Note

If you choose to use your own JAMMA Cable and not the one provided in the kit, be sure to check the JAMMA Cable Connector Chart to verify that it is compatible.

Caution

Properly insulate any unused wires within the JAMMA Cable, especially the gray, gray-green and gray-yellow wires. This is a fully wired JAMMA Cable. Many of the wires will not be used for this kit. These wires have been installed so that you can use this cable for future kits.

Note

The Ribbon Cable may need to be twisted in order to connect it properly.

Installing the PC Boards and Wiring into a JAMMA Game Cabinet

1. Disconnect and remove the existing video board in the JAMMA Game Cabinet.
2. Mount the PIGSKIN video board inside the JAMMA Game Cabinet where the old video board was located. Mount the sound board next to the video board using the stand-off and screws provided.
3. If you choose to use the JAMMA Cable provided with the kit, unsolder your old JAMMA cable from the speaker, power supply, control panel switches (which may already be disconnected) and coin door. Remove the cable from the game. If you are not going to use the JAMMA Cable provided with the kit, check the JAMMA Cable Connector Chart to be sure your cable is compatible. Leave your power supply chassis as is.
4. Connect the JAMMA Cable to JP7 on the PIGSKIN video board. Using the JAMMA Cable Connector Chart for reference, solder the correct JAMMA Cable wires to the speaker, power supply, control panel switches and coin door.
5. Connect the ribbon cable from J4 on the sound board to JP1 on the video board. Be sure that the red line goes to the same pin on both boards. Connect the wire harness cable from J5 (speaker), and J3 (power), on the sound board to JP2 (sound power speaker connector) on the video board.
6. Connect the video signal cable from JP6 on the video board to your monitor. Be sure that pin 1 on the monitor is connected to pin 1 on the video board and so on.
7. Connect the joystick harness from the video board to the joystick opto boards. The player 1 connector has red wires and is connected from JP4 on the video board to the opto board on the player 1 joystick. The player 2 connector has blue wires and is connected from JP5 on the video board to the opto board for the player 2 joystick. The power connector has 4 wires and is connected to JP8 on the video board.
8. JP3 on the video board is not used.
9. Place the FBI Warning Label on the inside of the cabinet next to the PC boards. Be sure the label is completely visible.

Installing the PC Boards and Wiring into a NON-JAMMA Game Cabinet.

1. Disconnect and remove the existing video board in the game cabinet.
2. Mount the PIGSKIN video board inside the Game Cabinet where the old video board was removed. Mount the sound board next to the video board using the stand-offs and screws provided.
3. Leaving several inches of wire, cut the wires at the coin door, control panel switches (which may already be disconnected) speaker and power supply.
4. Connect JAMMA Cable to video board at JP7. Follow the JAMMA Cable Connector Chart and splice the wires of the JAMMA Cable to the existing wires for the coin door, power supply, speaker and control panel. Be sure all of the spliced wires are well insulated with black electrical tape.
5. Connect the ribbon cable from J4 on the sound board to JP1 on the video board. Be sure that the red line goes to the same pin on both boards. Connect the wire harness cable from J5 (speaker), and J3 (power) on the sound board to JP2 (sound power speaker connector) on the video board.
6. Connect the video signal cable from JP6 on the video board to your monitor. Be sure that pin 1 on the monitor is connected to pin 1 on the video board.
7. Connect the joystick harness from the video board to the joystick opto boards. The player 1 connector has red wires and is connected from JP4 on the video board to the opto board on the player 1 joystick. The player 2 connector has blue wires and is connected from JP5 on the video board to the opto board on the player 2 joystick. The power connector has 4 wires and is connected to JP8 on the video board.
8. JP3 on the video board, is not connected.
9. Place the FBI Warning Label on the inside of the cabinet next to the PC boards. Be sure the label is completely visible.

Note

Be sure all spliced wires are well insulated with black electrical tape.

Caution

Properly insulate any unused wires within the JAMMA Cable, especially the gray, gray-green and gray-yellow wires. This is a fully wired JAMMA Cable. Many of the wires will not be used for this kit. These wires have been installed so that you can use this cable for future kits.

Note

The Ribbon Cable may need to be twisted in order to connect it properly.

Installing the Volume Control

1. Mount the volume control, using screws provided, where it is easily accessible. On top of the cash box, or on the wall near sound board are two possible locations.
2. The volume control cable attaches the volume control to the sound board at connector J2. When viewed with the white plastic knob facing you, the shield wire should be soldered to the right lug, the red wire should be soldered to the middle lug, and the black wire should be soldered to the left lug. Refer to Volume Control Diagram.

Volume Control Wiring Diagram

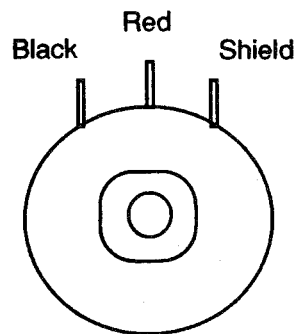

Game Rules and Features

Starting Up

Switch ON the power to the game. A "rug" pattern appears on the crt screen. The next screen shows PIGSKIN REVISION LEVEL. The game then moves to the attract mode. After the proper coinage has been inserted, the game exits the attract mode and enters play mode.

Player Controls

- Each Credit Button allows (1 or 2) players respectively, to begin play or continue play.
- Each Joystick enables players (1 or 2) respectively, to move their team captain.
- Four Buttons (per player) control Team Attitude Adjustment, Punch, and Pass. See diagram below for locations.

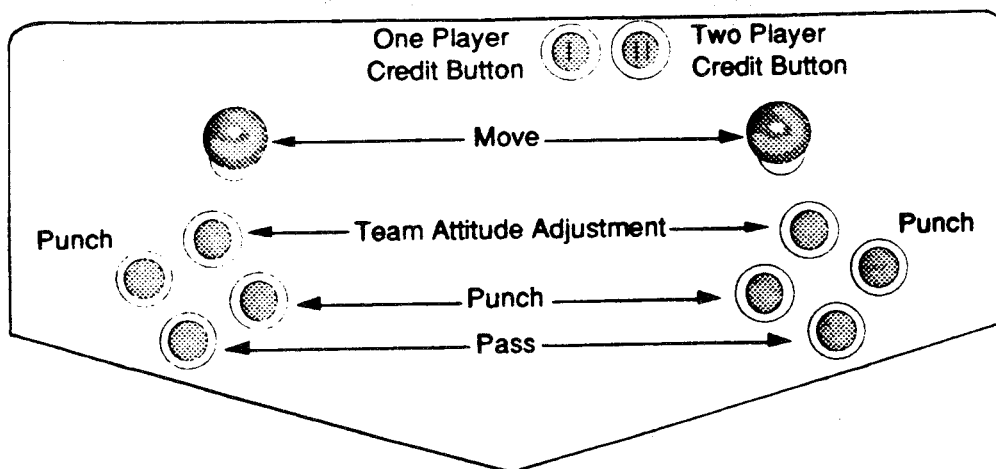

Game Operation

PIGSKIN is a one or two player video game that uses a color monitor. From the player's perspective, the game has two modes of operation: Ready-to-Play and Play. From the service technician's perspective, the game has an additional mode of operation called Game Diagnostics, which contains Self-Test and Game Adjustment features.

Control Switches

- **VOLUME CONTROL POTENTIOMETER** can be used to increase or decrease the volume level of the game music and speech. For greater profits, set your game's volume level at its maximum.
- **TEST/DIAGNOSTICS SWITCH** allows you to enter into the game's Diagnostic mode. Turn the game off. Push the Test Switch towards the left to enter the Diagnostics mode, turn the game on. To exit this mode, simply turn off the Test Switch. This is an optional switch. Game diagnostics can be reached via the DIP Switch.
- **SERVICE CREDIT SWITCH** is a special feature switch that allots credit without affecting the game's coin totals. This switch is optional, the game operates without it.
- **COIN DOOR SLAM TILT SWITCH** detects any forceful vibrations against the Coin Door. This eliminates pounding for free games. This switch is optional, the game operates without it.

Game Adjustments & Diagnostics

Starting Up

All PIGSKIN game adjustments and diagnostics are menu-driven features. Each menu lists several choices that you may act upon as desired. PIGSKIN contains many menu levels (i.e., one menu selection will send the game to another menu).

Switch on the power to the game. Set DIP Switch 6 to On (or use the optional test switch, if you have installed one). The first menu you see is the main test menu. Game adjustments, bookkeeping, and diagnostics are all available from this menu.

Once in the main test menu, use the PLAYER JOYSTICK to select an option and the one or two player CREDIT BUTTON to enter into it. Notice that the selected option is always the one that has the cursor in front of it.

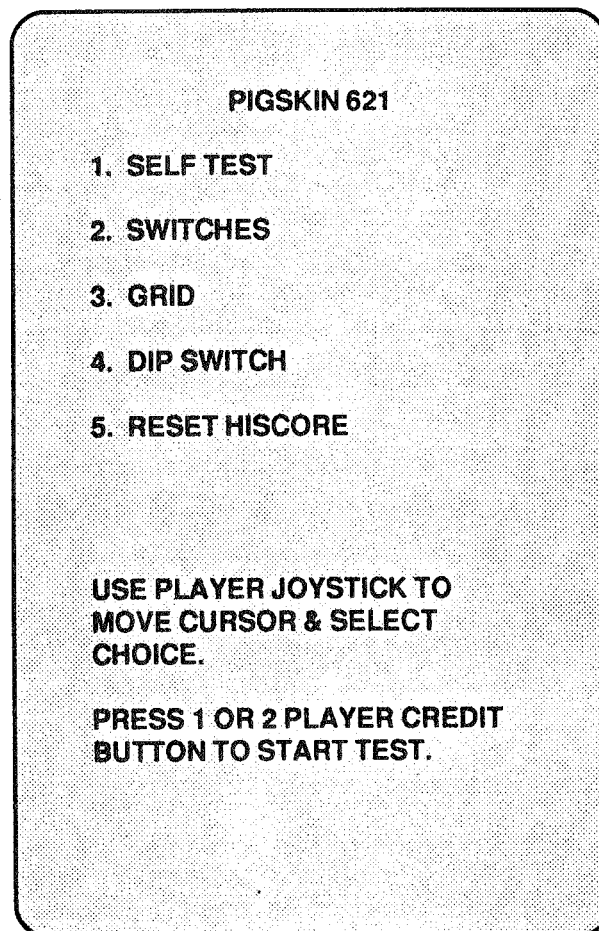

Main Test Menu

PIGSKIN DIAGNOSTICS & ADJUSTMENTS

SELF TEST

This test is designed to locate and identify any computer malfunctions. When selected, the game enters this mode immediately and begins scanning its memory. The phrases "PASSED TEST" or "FAILED TEST" will appear on the screen depending on whether the test was successful or not.

SWITCHES

The Switch and Sound Self-Test mode allow the operator to determine if all game switches, sound features, and the opto-board controlled joysticks are operating properly. The operator can activate switches one at a time and check the monitor screen to see if they are acknowledged.

GRID

The Convergence Grid Display Test displays a crosshatch pattern to aid in adjusting the color monitor. This pattern is useful in adjusting the color balance, convergence, vertical linearity, and vertical/horizontal sizing. To exit this test, press the Tilt switch.

DIP SWITCH

Game options are adjustable by changing the bit switch settings on the DIP Switch Table (shown on the next page). The DIP Switch unit combines seven bit switches, which are set to the ON or OFF position. When you enter this test mode, the screen shows a full display of current DIP Switch settings.

RESET HISCORE

The operator may reset the high scores by pressing both the 1 and 2 Player Credit Buttons simultaneously.

PIGSKIN DIP SWITCH TABLE

BITS	1	OFF	→	MEDIUM
	2	OFF	→	PRESET TIME
	1	ON	→	SHORT
	2	OFF	→	TIME
	1	OFF	→	LONG
	2	ON	→	TIME
	1	ON	→	SHORTEST
	2	ON	→	TIME
BITS	3	OFF	→	1 COIN 1CREDIT
	4	OFF	→	
	3	ON	→	2 COIN GAME
	4	OFF	→	
	3	OFF	→	SET YOUR OWN COIN *
	4	ON	→	OPTIONS
	3	ON	→	FREE PLAY
	4	ON	→	
BIT	5	ON	→	ATTRACT SOUNDS OFF
BIT	5	OFF	→	ATTRACT SOUNDS ON
BIT	6	OFF	→	TEST SWITCH OFF
BIT	6	ON	→	TEST SWITCH ON
BIT	7	OFF	→	NORMAL COIN CHUTES
BIT	7	ON	→	INDEPENDENT COIN * *
				CHUTES
BIT	8	ON	→	ROTATE JOYSTICK (TOP)
BIT	8	OFF	→	REGULAR JOYSTICK (RIGHT)

* After selecting this option through DIP SWITCH (3 & 4) return to the main menu and select (Coin Settings). Select the desired number of coins with the player 1 (increments of 1) & player 2 Credit buttons (decrements of 1). Follow the same procedure for selecting the desired number of credits per coin.

NOTE: This menu item will only be displayed when the appropriate DIP Switches have been correctly set as shown in the table above.

** After selecting this option through DIP SWITCH (7) return to the main menu and select (Independent Coin Chutes). Select a coin chute by pressing the one or two player Credit button. Set the Coin and Credit options in the same manner as explained above.

NOTE: This menu item will only be displayed when the appropriate DIP Switch has been correctly set as shown in the table above.

Troubleshooting Information

Problem...

No picture or distorted picture.

Turn game on and nothing happens.

No Sound.

Move joystick, but player does not move or fire.

Press START button and nothing happens.

Put coins in and get too many credits.

Put in coins and you don't receive a credit.

Game stays in the test mode.

Possible Solution...

Faulty video board or monitor.
Missing or disconnected video signal cable.

Check that +5V is going to pins C, D, 3 and 4 of the JAMMA Connector. Check for the LED on the CPU Board.

Check volume control setting. Check that +12V is going to pins F and 6 on the JAMMA Connector. Check that -5V is going to pins 5 & E of the JAMMA Connector. Check interboard wiring from video board to sound board. Check the speaker and speaker connection to pins L and 10 on the JAMMA Connector.

Check for open wires between joystick and CPU Board. Check for contamination on joystick optos and CPU Board pins. Check for proper ground.

Check for open wires between button Video Board. Check for contamination on video board pins or switch blades. Check for proper grounding on buttons.

Check for short between JAMMA Connector pins T and 16. Check coinage setting.

Check DIP switch coin setting and for contamination on switch contacts. Check for an open wire between Coin Switch 1 and pin 16 of the JAMMA Connector or Coin Switch 2 and pin T of the JAMMA Connector. Refer to Coin Switch & Coin Meter Wiring.

Check that the Test Switch in the coin door and the Test Switch (position 6) on the DIP Switch are set to Off.

Problem...

Vertical Jitter in video.

Possible Solution...

Vertical Jitter appears as if the whole screen is two images separate from each other. Vertically mounted monitors jitter from left to right.

Adjusting the vertical hold on the monitor may eliminate jitter. If adjusting the vertical hold doesn't eliminate jitter, or the adjustment is too fine to remain intact your monitor may not be capable of handling the interlaced synchronization signals that PIGSKIN generates. This is a deficiency with the monitor. Contact your monitor's manufacturer for further assistance.

Changing the value of C67, a .47 μ F capacitor located on the video board near JP6 may correct an interlacing problem. Use a non-polarized capacitor when increasing or decreasing the value of C67. *With a Wells Gardner monitor remove C67 for the best possible picture.*

The following are some of the monitors that are compatible with PIGSKIN video synchronization: Electrohome, Wells Gardner and Hantarex 900 series. The newer Hantarex 9000 series monitors require a minor modification, contact Hantarex for more information 708-843-7226.

Wells Gardner can fix jitter problems with the 7900 series monitors. For more information call 312-252-8220.

Notes

PIGSKIN

Game Parts Information

S
E
C
T
I
O
N

T
W
O

C-13246-4004 PIGSKIN CPU Board

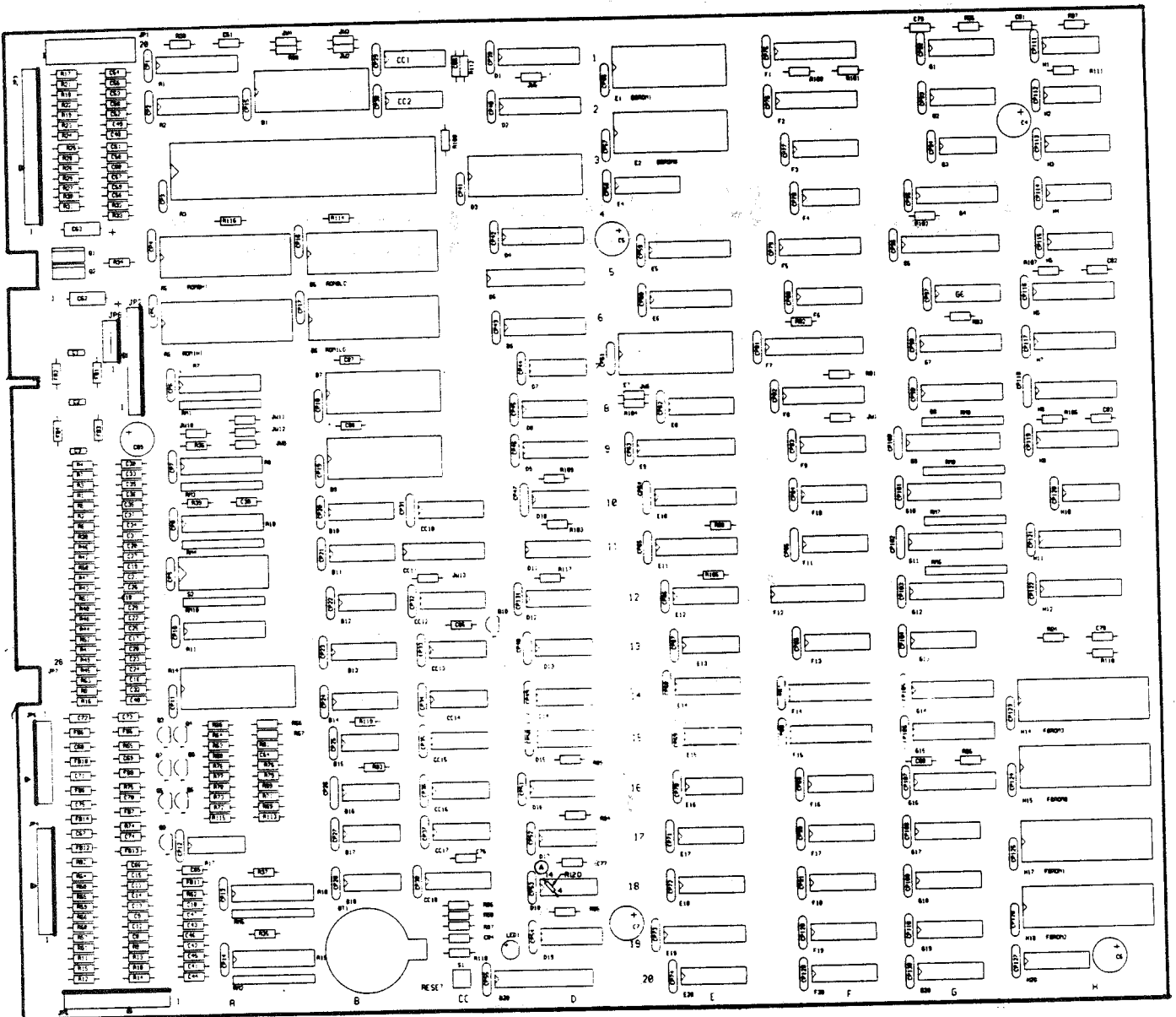

PIGSKIN CPU Board Assembly

Description	Designation	Part Number	Description	Designation	Part Number
7406 IC	A17	5280-08974-00	300pF AX. CER. CAP.	C64,C76	5048-11064-00
74F00 IC	H1,E16	5283-10551-00	320pF AX. CER. CAP.	C48,C49,C50,C51,C52,C53, C64,C55,C56,C57,C58, C68,C60,C61,C65,C66, C74,C75	5048-12506-00
74F04 IC	B15,D15	5283-10552-00			
74F08 IC	CC17	5283-12488-00			
74F20 IC	D13	5283-12557-00	.01uF AX. CER. CAP.	CP(1-131),C1,C2,C3,C77,C86, C87,C88	5043-08980-00
74F32 IC	CC13	5283-12489-00			
74F74 IC	CC2,D18	5283-10468-00	1uF AX. CER. CAP.	C65	5043-08986-00
74F86 IC	CC15,F4	5283-12486-00	.47uF AX. CER. CAP.	C67	5048-12577-00
74F157 IC	H3	5283-12487-00	FERRITE BEAD	FB1,FB2,FB3,FB4,FB5,FB6, FB7,FB8,FB9,FB10,FB11, FB12,FB13,FB14	5556-12513-00
74F174 IC	F13	5283-12484-00			
74HC541 IC	A7,A8,A10,A18,A19	5311-12287-00			
74LS00 IC	D14	5281-09499-00	20 PIN HEADER (DUAL .100)	JP1	5791-09437-00
74LS02 IC	E13	5281-09247-00	8 PIN HEADER (.156)	JP2	5791-10862-00
74LS14 IC	B12	5281-09851-00	18 PIN HEADER (.100)	JP3	5791-12461-18
74LS20 IC	H10,CC14	5281-10014-00	12 PIN HEADER (.100)	JP4,JP5	5791-12461-12
74LS27 IC	D7	5281-09852-00	9 PIN HEADER (.100)	JP6	5791-12461-09
74LS32 IC	B16,CC16	5281-09500-00	4 PIN HEADER (.100)	JP8	5791-12461-04
74LS74 IC	H2,D10,B17,D17,B18	5281-09487-00	RED LED	LED1	5671-09019-00
74LS96 IC	Q3,E15	5281-09737-00	JUMPER WIRE (ODRES.)	JW1,JW2,JW3,JW6,JW9,JW10, JW13	5610-09534-00
74LS153 IC	G1,F3	5281-10016-00			
74LS157 IC	D8,B10,CC10,B11,B14, B13,D9,E4	5281-09738-00	TIP110 TRANS.	Q1,Q2	5162-12506-00
74LS163 IC	D12,E12,D16	5281-10037-00	MPSA70 TRANS.	Q3,Q4,Q5,Q6,Q7,Q8	5192-12507-00
74LS169 IC	F8,F9,F11,G13	5281-09855-00	2N4123 TRANS.	Q9	5160-12510-00
74LS173 IC	E14	5281-10040-00	2N3906 TRANS.	Q10	5190-10270-00
74LS174 IC	Q2,Q6,E17,E20	5281-09733-00	PUSHBUTTON SWITCH	S1	5641-12551-00
74LS175 IC	E18	5281-10043-00	10 POS. DIP SWITCH	S2	5645-12512-00
74LS244 IC	E5,A11	5281-09867-00	BATTERY HOLDER	BT1	5881-12315-00
74LS194 IC	G17,F18,G18,F19,G19, F20,G20,H20	5281-09743-00	BARE PCB	PCB	5770-12552-00
74LS245 IC	D4,E6	5281-09308-00	18 PIN IC SOCKET (.300)	CC18,D11	5700-09006-00
74LS258 IC	F16,F17	5281-09744-00	20 PIN IC SOCKET (.300)	CC11,D6,E10,E11,E19,F8,F14, F15	5700-09498-00
74LS273 IC	A1,F1,A2,F2,G4,G14	5281-09736-00	24 PIN IC SOCKET (.300)	D5,E9,F7,F12,G5,G6,G10,G11, G12	5700-12047-00
74LS283 IC	E8,F10	5281-09734-00	28 PIN IC SOCKET (.300)	A14,B1,B7,B9,D3,E1,E2,E7	5700-10176-005
74LS298 IC	H4,H5	5281-12514-00	32 PIN IC SOCKET (.300)	A5,A6,B5,B6,H14,H15,H17,H18	700-12088-00
74LS374 IC	H8,G7,H7,G8,H8,H9, H11,H12	5281-09486-00	64 PIN IC SOCKET (.300)	A3	5700-10453-00
MAX695 IC	D1, D2,F5,G15,G16	5281-09741-00	27512 ROM OH1	A5	A-5343-4004-7
16MHz CRYSTAL OSC	CC12	5434-12550-00	27512 ROM 1H1	A6	A-5343-4004-6
20MHz CRYSTAL OSC	CC1	5521-12501-00	27512 ROM 0L0	B5	A-5343-4004-5
10 RES., 5% 1/4 WATT	D19	5521-10743-00	27512 ROM 1L0	B6	A-5343-4004-4
22 RES., 5% 1/4 WATT	R63,R64,R72,R73,R76,R77	5010-09039-00	27512 ROM BG1	E1	A-5343-4004-9
47 RES., 5% 1/4 WATT	R92	5010-09434-00	27512 ROM BG0	E2	A-5343-4004-8
68 RES., 5% 1/4 WATT	R86,R87,R88,R90	5010-10170-00	27010 ROM FG3	H14	A-5343-4004-10
100 RES., 5% 1/4 WATT	R85,R89,R93	5010-12480-00	27010 ROM FG0	H15	A-5343-4004-11
	R17,R18,R19,R20,R21,R22, R23,R24,R25,R26,R27, R28,R29,R30,R110	5010-09036-00	27010 ROM FG1	H17	A-5343-4004-12
			27010 ROM FG2	H18	A-5343-4004-13
330 RES., 5% 1/4 WATT	R118	5010-09001-00	2Kx8 RAM, 120nS	D3,E7	5340-12500-00
470 RES., 5% 1/4 WATT	R65,R74, R75	5010-09416-00	2018-45, 2Kx8 RAM, 45nS	G9,G10,G11,F12,G12	5340-12497-00
510 RES., 5% 1/4 WATT	R68,R71,R80	5010-12483-00	100nS 8Kx8 RAM, (ultra low pwr.)	B7,B9	5340-12558-00
560 RES., 5% 1/4 WATT	R62,R81,R82	5010-08992-00	53418, 64x8 RAM	A14	5340-12499-00
1K RES., 5% 1/4 WATT	R67,R70,R79,R113,R115	5010-09358-00	MC6840 IC	B1	5431-12499-00
2K RES., 5% 1/4 WATT	R66,R69,R78	5010-09999-00	68000 IC	A3	5400-12498-00
2.7K RES., 5% 1/4 WATT	R31,R32,R33,R34,R35, R36,R37	5010-08997-00	PAC00 IC, PLD	F15	A-5346-4004-1
4.7K RES., 5% 1/4 WATT	R63,R64,R91,R98,R99,R100, R101,R102,R103,R104, R105,R108,R109,R111, R112,R114,R116,R117, R119,R120	5010-08991-00	PACNS IC, PLD	F14	A-5346-4004-2
10K RES., 5% 1/4 WATT	R1,R2,R3,R4,R5,R6,R7,R8, R9,R10,R11,R12,R13,R14, R15,R16,R38,R39,R40,R41, R42,R43,R44,R45,R46,R47, R48,R49,R50,R51,R52,R53, R54,R55,R56,R57,R58,R59, R60,R61	5010-09034-00	ROMCTRL IC, PLD	E19	A-5346-4004-3
1K SIP RES., 10 PIN	RM6,RM7,RM8,RM9	5019-09669-00	VERTTIME IC, PLD	F7	A-5346-4004-4
100K SIP RES., 10 PIN	RM1,RM2,RM3,RM4,RM5	5019-12509-00	HORIZTIME IC, PLD	E9	A-5346-4004-5
4.7K SIP RES., 10 PIN	RM10	5019-09362-00	MISCV IC, PLD	F8	A-5346-4004-6
16uF RD. ELEC. CAP., 10V	C62,C63	5041-09243-00	MISCHV IC, PLD	E11	A-5346-4004-7
470uF RD. ELEC. CAP., 16V	C4,C5,C6,C7,C89	5040-09776-00	COLARB IC, PLD	G5	A-5346-4004-8
47pF AX. CER. CAP.	C68,C69,C70,C71,C72,C73	5043-09844-00	DEC0E0 IC, PLD	D5	A-5346-4004-9
100pF AX. CER. CAP.	C8,C9,C10,C11,C12,C13,C14, C15,C16,C17,C18,C19,C20, C21,C22,C23,C24,C25,C26, C27,C28,C29,C30,C31,C32, C33,C34,C35,C36,C37,C38, C39,C40,C41,C42,C43,C44, C45,C46,C47	5048-11029-00	DEC0E1 IC, PLD	D6	A-5346-4004-10
			DEC0E2 IC, PLD	CC11	A-5346-4004-11
			HENABLE IC, PLD	E10	A-5346-4004-12
			74LS368 IC	CC18	5281-09746-00
			74LS157 IC	D11	5281-09738-00
			3.6V BR2325 BATTERY	BT1	5880-11056-00
			1/4 SPACER		63-8338-1
			SUB-ASSEMBLY		C-13247-1
			LABEL		16-8800-29B

C-13581-1
49-way Joystick Assembly

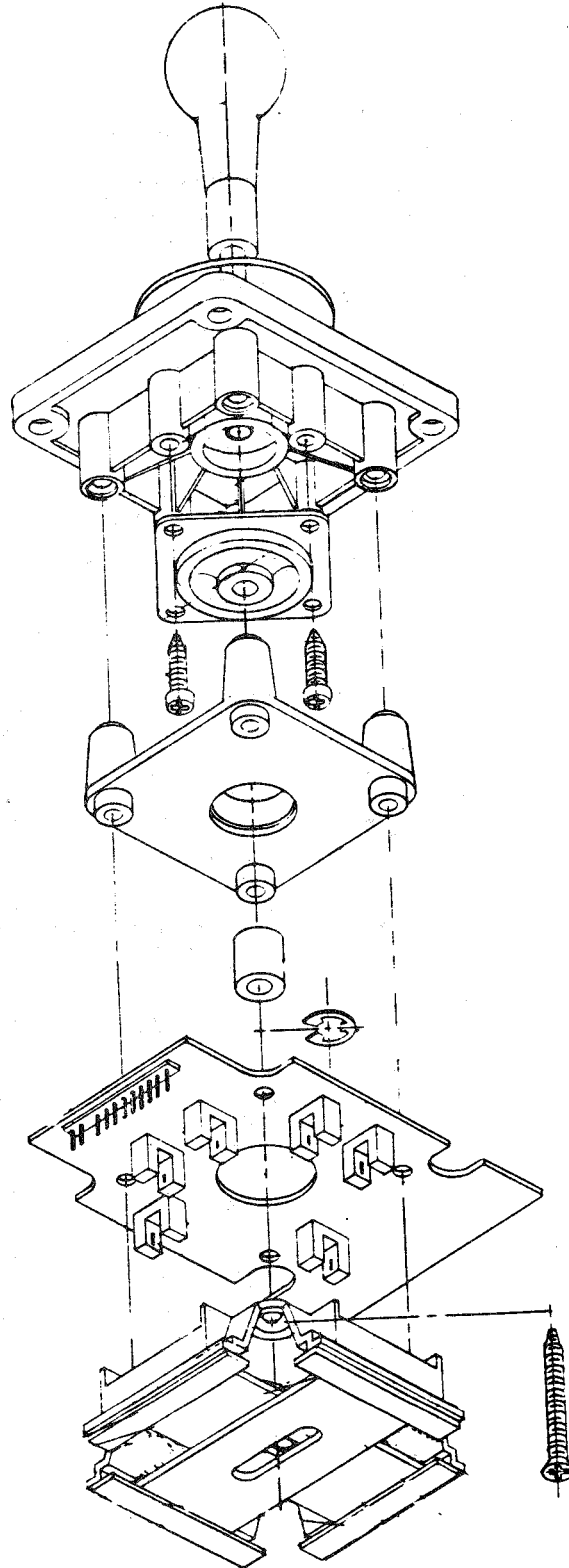

C-13706

49-way Joystick Opto Board

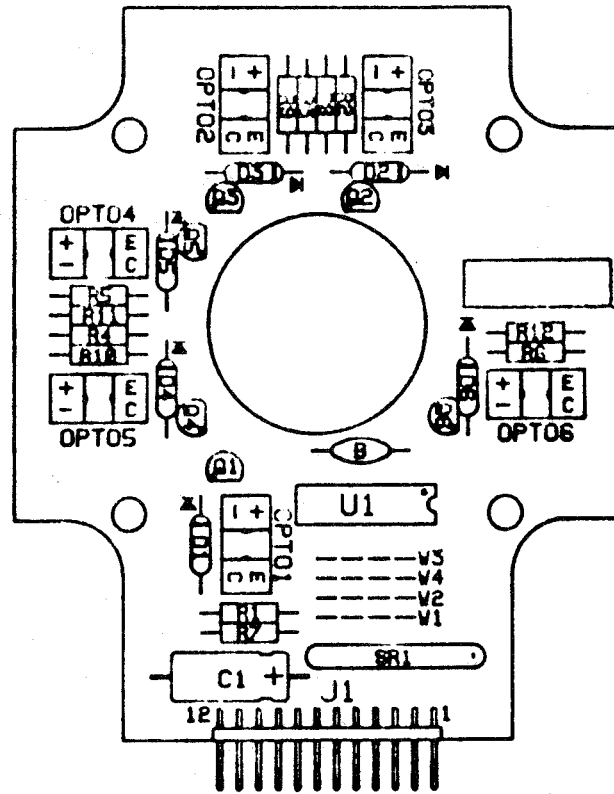

Item	Part Number	Ckt Designation	Description
1	5772-12657-00		Bare PC Board
2	16-8850-302		I.D. Label
3	5310-09155-00	U1	I.C. 4011
4	5040-08986-00	C1	Capacitor, 100 μ F
5	5490-10159-00	Opto 1- Opto 6	Opto
6	5010-097684-00	R1 - R6	Resistor, 180 Ω
7	5010-09034-00	R7- R12	Resistor, 10K Ω
8	5070-08919-00	D1 - D6	Diode, 1N4148
9	5160-08938-00	Q1 - Q6	Transistor, 2N4401
10	5043-08980-00	Bypass	Capicator, .01 μ F
11	5019-10029-00	SR1	SIP, 4.7K Ω
12	5010-09534-00	W2, W4	Jumper, 0 Ω
13	5791-12548-12	J1	Header, 12 pin, Right Angle

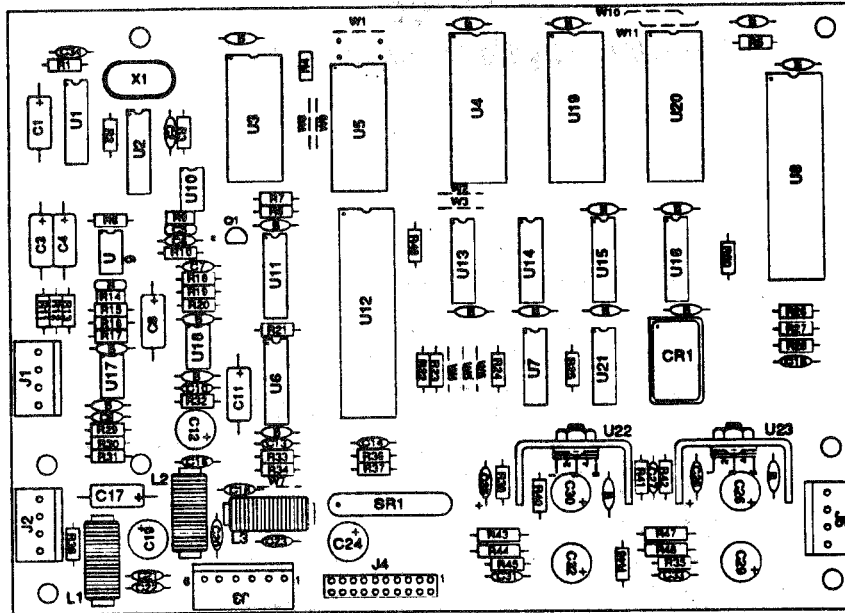

D-11581-4004 Audio Board Assembly

Part Number	Ckt Designator	Description	Part Number	Ckt Designator	Description
5700-10178-00	U4, U19, U20	Socket, IC, 28 PIN	5010-10965-00	R14, R15	Resistor, 20K, 1/4w, 5%
5766-12130-00		Bare P. C. Board	5010-09034-00	R22-R24, R17, R34	Resistor, 10K, 1/4w, 5%
5371-11067-00	U1	IC, D/A Conv, YM3012	5010-09324-00	R6, R19, R20, R21	Resistor, 27K, 1/4w, 5%
a) 5700-09006-00		Socket, IC, 16-pin (U1)	5010-09086-00	RIG	Resistor, 6.8K, 1/4w, 5%
5370-11066-00	U3	IC, Sound Processor, YM2151	5010-09534-00		Resistor, 0Ω, C.F., 1/4W
a) 5700-09004-00		Socket, IC, 24-pin (U3)	5010-09162-00	R39	Resistor, 100K, 1/4w, 5%
5400-10320-00	U8	IC, μProcessor, MC68B09E	5010-09331-00	R16	Resistor, 13K, 1/4W, 5%
a) 5700-08985-00		Socket, IC, 40-pin (U8)	5010-08772-00	R18	Resistor, 15KΩ, 1/4W, 5%
5343-4004-1	U4	IC, Audio ROM 1	5010-08824-00	R32	Resistor, 43KΩ, 1/4W, 5%
5343-4004-2	U19	IC, Audio ROM 2	5010-08846-00	R31	Resistor, 220KΩ, 1/4W, 5%
5343-4004-3	U20	IC, Audio ROM 3	5010-08991-00	R12	Resistor, 4.7KΩ, 1/4W, 5%
a) 5700-10178-00		Socket, IC, 28-pin (U4, U19)	5010-09219-00	R38	Resistor, 8.2K, 1/4W, 5%
5371-09152-00	U11	IC, D/A Convtr, MC1406	5010-10258-00	R40	Resistor, 1M, 1/4w, 5%
5430-10322-00	U12	IC, PIA, MC68B21	5010-09179-00	R10	Resistor, 3.3M, 1/4w, 5%
5340-10139-00	U5	IC, RAM/S 5516-2 2Kx8	5010-09333-00	R29	Resistor, 180KΩ, 1/4W, 5%
5281-09487-00	U16	IC, Dual D Flipflop, 74LS74	5010-09342-00	R30	Resistor, 36KΩ, 1/4W, 5%
5281-10043-00	U13	IC, 74LS175	5010-09534-00	W9	Resistor, 0Ω, 1/4w, 5%
5281-09235-00	U21	IC, Triple NAND, 74LS10	5040-09343-00	C1, C3, C4, C6, C17	Capacitor, 10μfd, 20v, ±20%
5370-09321-00	U9, U10, U17, U18	IC, Op Amp, MC1458	5040-10974-00	C12, C19, C24	Capacitor, 100μfd, 35v
5281-09215-00	U2	IC, Hex Inv, 74LS04	5040-09778-00	C26, C30	Capacitor, 470μfd, 16v, +50, -10%
5281-09246-00	U14	IC, 2-4 Dec, 74LS139	5040-12008-00	C29, C32	Capacitor, 1000μfd, 16v, 20%
5281-09745-00	U15	IC, Dual Mux, 74LS138	5041-09243-00	C25, C28	Capacitor, 10μfd, 10v, ±10%
5370-09158-00	U22, U23	IC, Audio Amp, TDA2002	5043-08980-00	C5, B (20)*	Capacitor, 0.01μfd, 50v, +80, -20%
a) 5705-09199-00		Heatsink, #60308	5043-08998-00	C31, C33	Capacitor, 0.1μfd, 50v, ±20%
b) 4006-01003-06		Mach. Screw, 6-32 x 3/8	5043-09065-00	C13 - C15	Capacitor, 470 pfd, 50v, ±20%
c) 4406-01117-00		Nut, 6-32 Hex.	5043-09492-00	C2, C34	Capacitor, 100 pfd, 50v, ±10%
d) 4703-00007-00		Lockwasher, #6 Ext.	5043-09644-00	C8	Capacitor, 47 pfd, 50v, ±20%
5160-10289-00	Q1	Transistor, 2N3904, NPN	5043-09845-00	C16, C18, C20 - C23, C27	Capacitor, 1000 pfd, 50v, ±20%
5060-10396-00	SP1	SNIP 4.7K & 470pfd, 8P8C	5040-09365-00	C11	Capacitor, 1μfd, +50v, -10%
5010-09181-00	R44, R48	Resistor, 1.0Ω, 1/2w, 5%	5048-09346-00	C7	Capacitor, 1200P, 50v, +/-5%
5010-09181-00	R35, R45	Resistor, 2.2Ω, 1/4w, 5%	5048-10992-00	C10	Capacitor, 4700P, 50v, +/-10%
5010-09361-00	R43, R46, R47	Resistor, 220Ω, 1/2w, 5%	5046-09350-00	C9	Capacitor, 180P, 100v, +/-5%
5010-09358-00	R41, R42	Resistor, 1K, 1/4w, 5%	5520-09020-00	X1	Crystal, 3.68 MHz
5010-09998-00	R2, R3,	Resistor, 2.2K, 1/4w, 5%	5521-10931-00	CR1	Oscillator, 8 MHz
5010-08983-00	R7-R9	Resistor, 3.3K, 1/4w, 5%	5551-09622-00	L1 - L3	Inductor, 4.7 μH, 3A
5010-08991-00	R1, R4, R5, R11, R25 - R28, R33, R36, R37, R49, R50	Resistor, 4.7K, 1/4w, 5%	5791-09437-00	J4	Connector, 20 pin, (Hdr), Rib. Cbl
			5791-10862-04	J1, J2, J5	Connector, 4 pin (Hdr)
			5791-10862-06	J3	Connector, 8 pin (Hdr)
			16-8850-297		P.C.B. I.D. Label

Notes: *20 capacitors (shown on diagram with "B" symbol) provide +5VDC filtering for ICs.
All capacitors are ceramic, 50v, axial, unless otherwise noted.
All resistors are 5%, 1/4w, Carbon Film, unless otherwise noted.

PIGSKIN

Diagrams & Schematics

S
E
C
T
I
O
N

T
H
R
E
E

PIGSKIN JAMMA Chart

Function	Wire Color	Pin	Pin	Wire Color	Function
GROUND	BLK	1	A	BLK	GROUND
GROUND	BLK	2	B	BLK	GROUND
+5 VOLTS DC	GRY	3	C	GRY	+5 VOLTS DC
+5 VOLTS DC	GRY	4	D	GRY	+5 VOLTS DC
- 5 VOLTS DC	GRY-GRN	5	E	GRY-GRN	- 5 VOLTS DC
+12 VOLTS DC	GRY-YEL	6	F	GRY-YEL	+12 VOLTS DC
	KEY	7	H	KEY	
COUNTER 1 *	WHT-ORG	8	J	WHT-GRN	COUNTER 2 *
	N/C	9	K	N/C	
SPEAKER (+)	RED-VIO	10	L	GRN-VIO	SPEAKER (-)
	N/C	11	M	N/C	
VIDEO RED	RED	12	N	GRN	VIDEO GRN
VIDEO BLU	BRN	13	P	WHT	VIDEO SYNC
VIDEO GND	SHIELD	14	R	WHT-RED *	SERVICE *
TEST **	GRN *	15	S	WHT-VIO *	TILT *
COIN 1	WHT-BLU	16	T	YEL-WHT	COIN 2
START 1	YEL-GRN	17	U	YEL-BLU	2 START
N/C	ORG-BLK	18	V	YEL-BLK	N/C
N/C	ORG-BRN	19	W	YEL-BRN	N/C
N/C	ORG-RED	20	X	YEL-RED	N/C
N/C	ORG	21	Y	YEL-ORG	NC
1PUNCH	ORG-YEL	22	Z	YEL-VIO	2 PUNCH
1 PASS	ORG-GRN	23	a	YEL-GRY	2PASS
1 ATT. ADJ.	ORG-BLU	24	b	VIO-BLK	2 ATT. ADJ.
N/C	ORG-VIO	25	c	VIO-BRN	N/C
N/C	ORN-GRY	26	d	VIO-RED	N/C
	N/C	27	e	BLK	GROUND
GROUND	BLK	28	f	BLK	GROUND

* Optional functions -- Game will function without these

49-way Joystick Opto Board Schematic

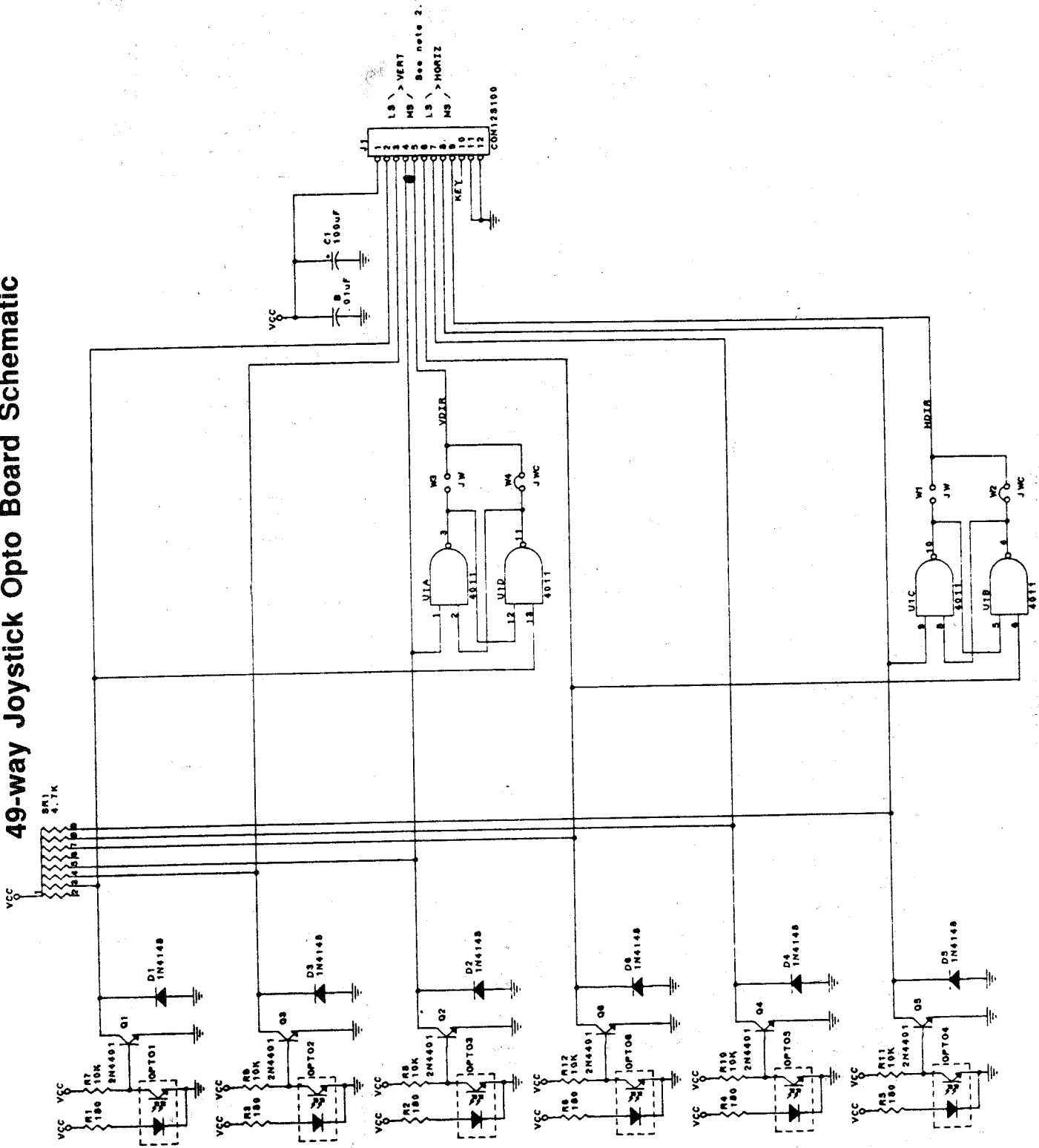

CPU Schematic Sheet 1 of 12

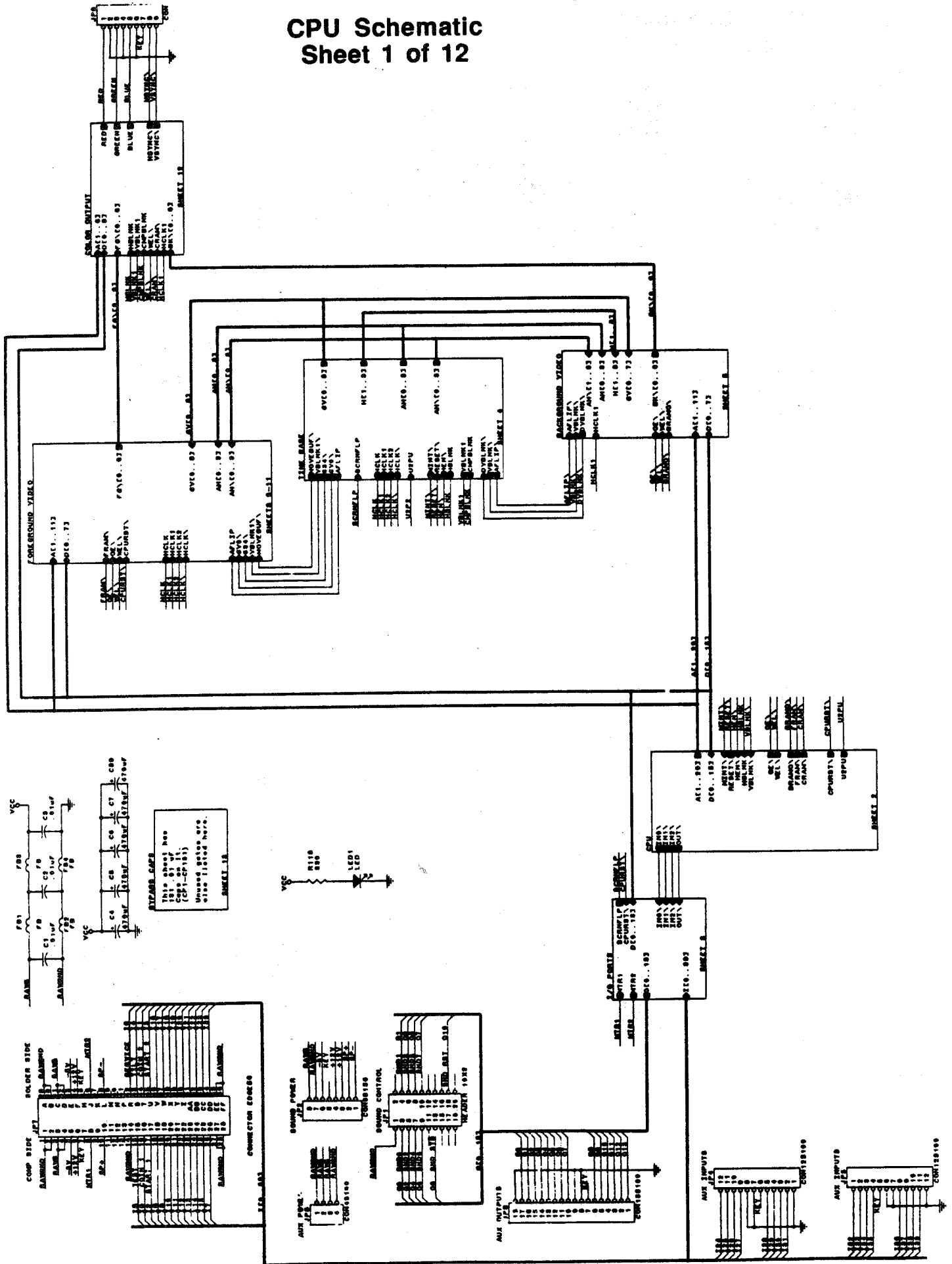

CPU Schematic Sheet 2 of 12

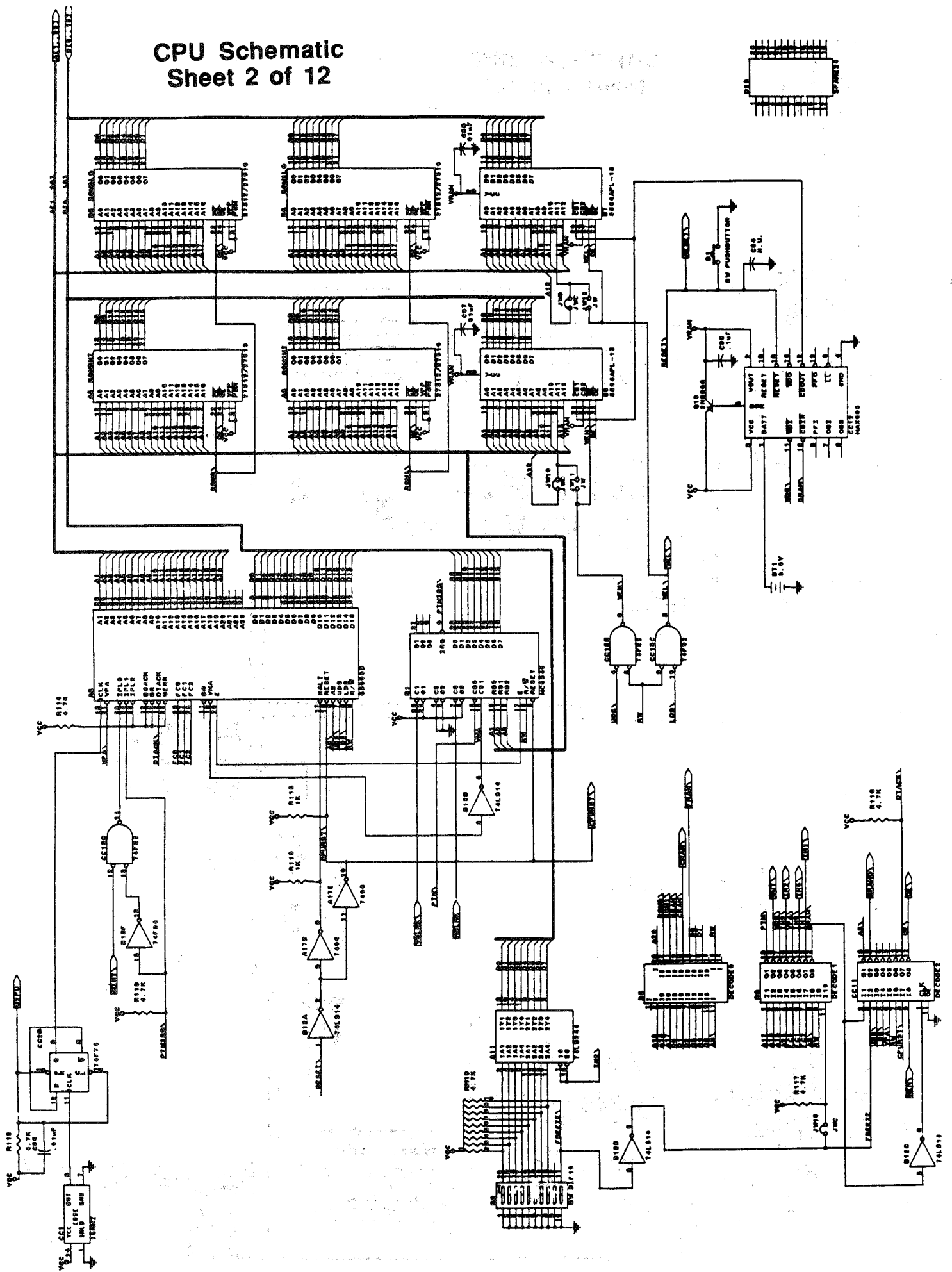

CPU Schematic

Sheet 3 of 12

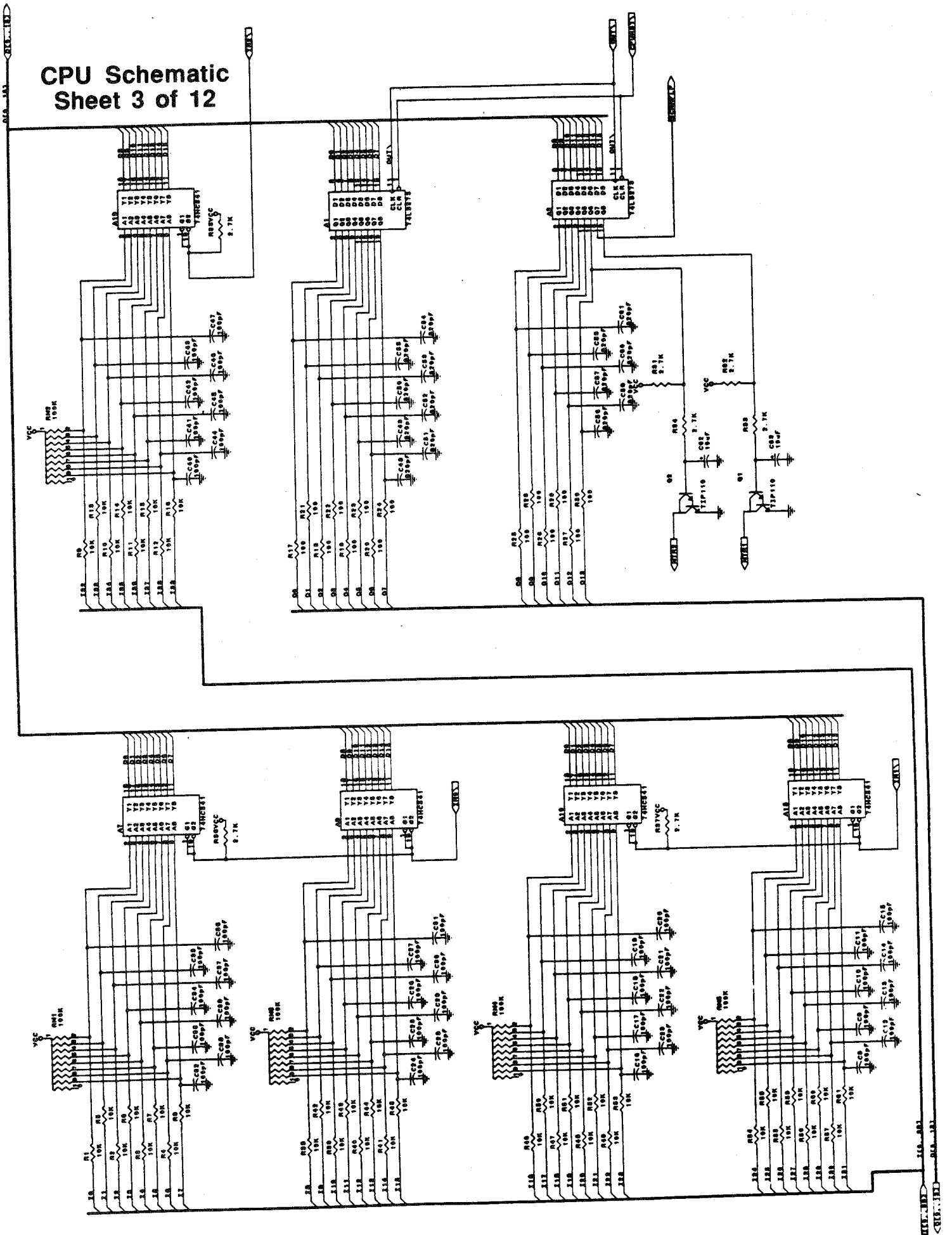

CPU Schematic

Sheet 4 of 12

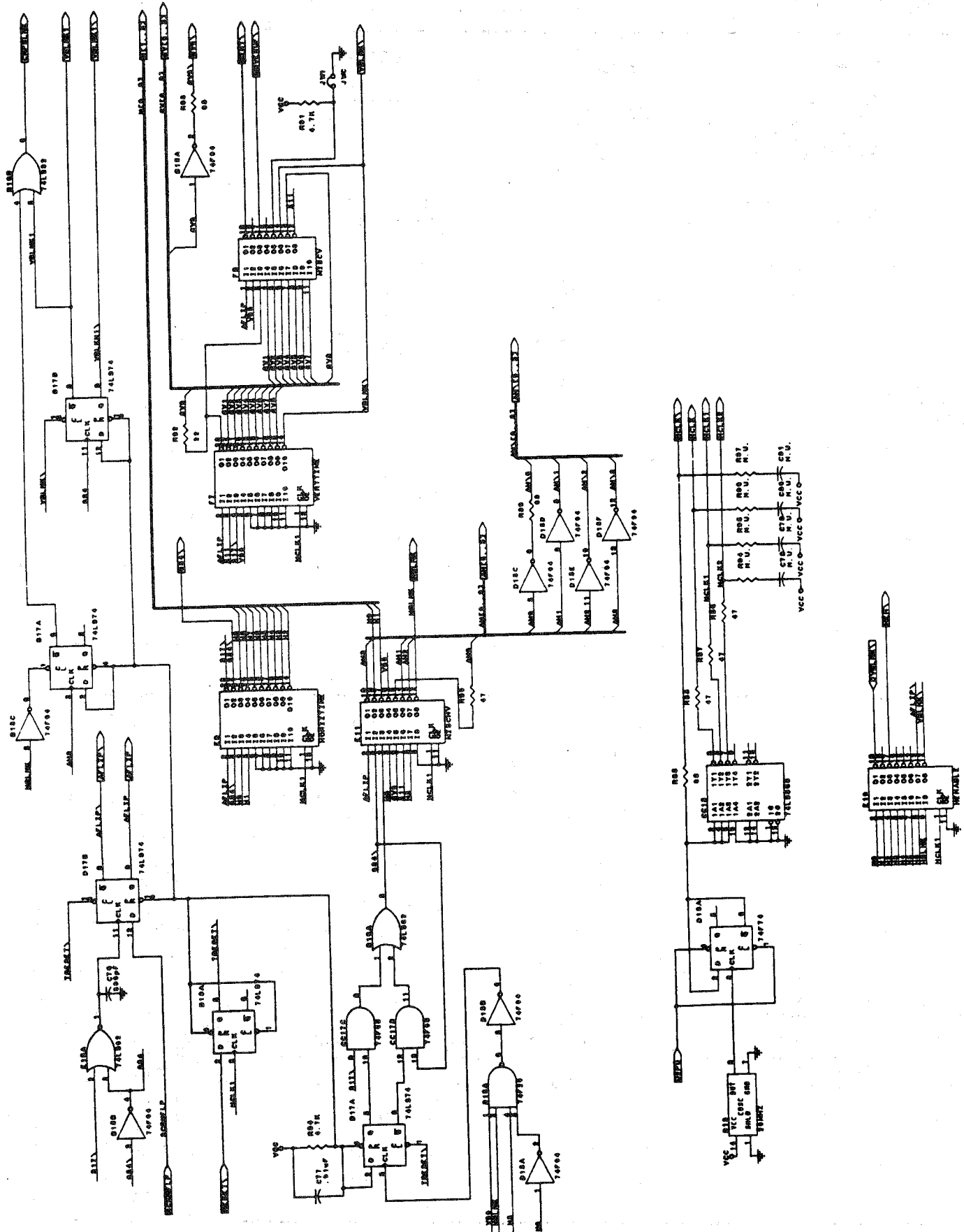

CPU Schematic Sheet 5 of 12

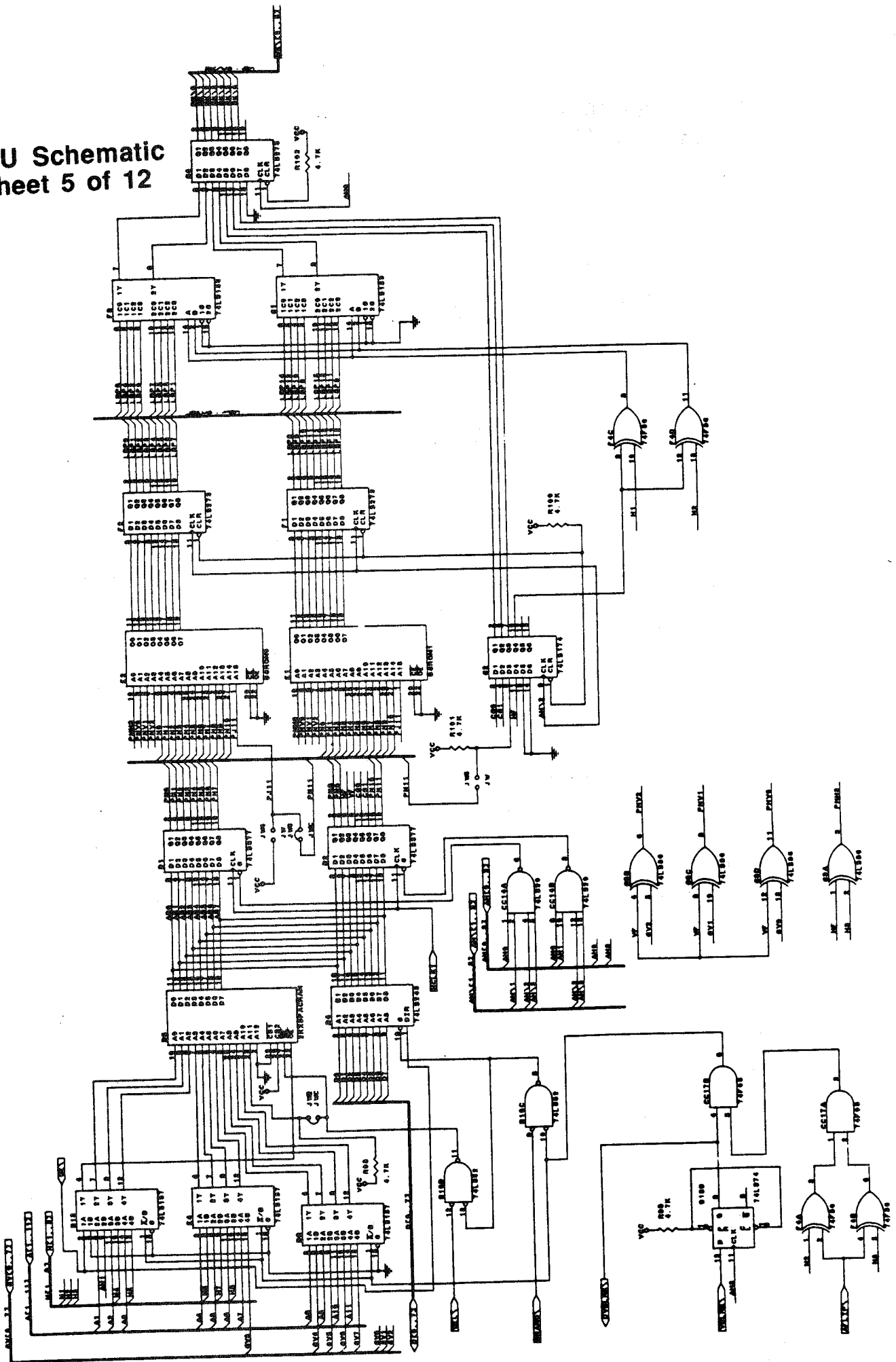

CPU Schematic Sheet 7 of 12

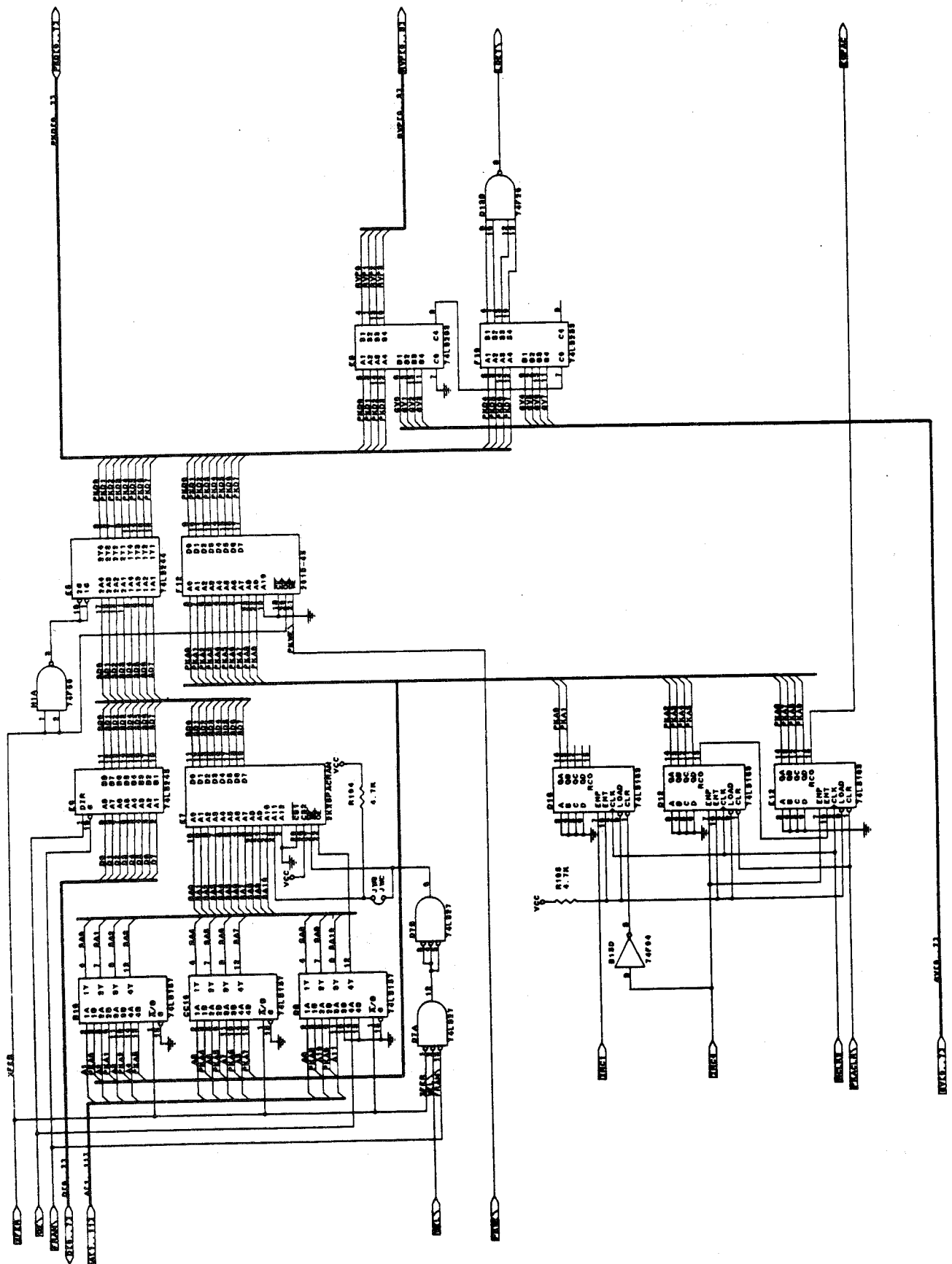

CPU Schematic

Sheet 8 of 12

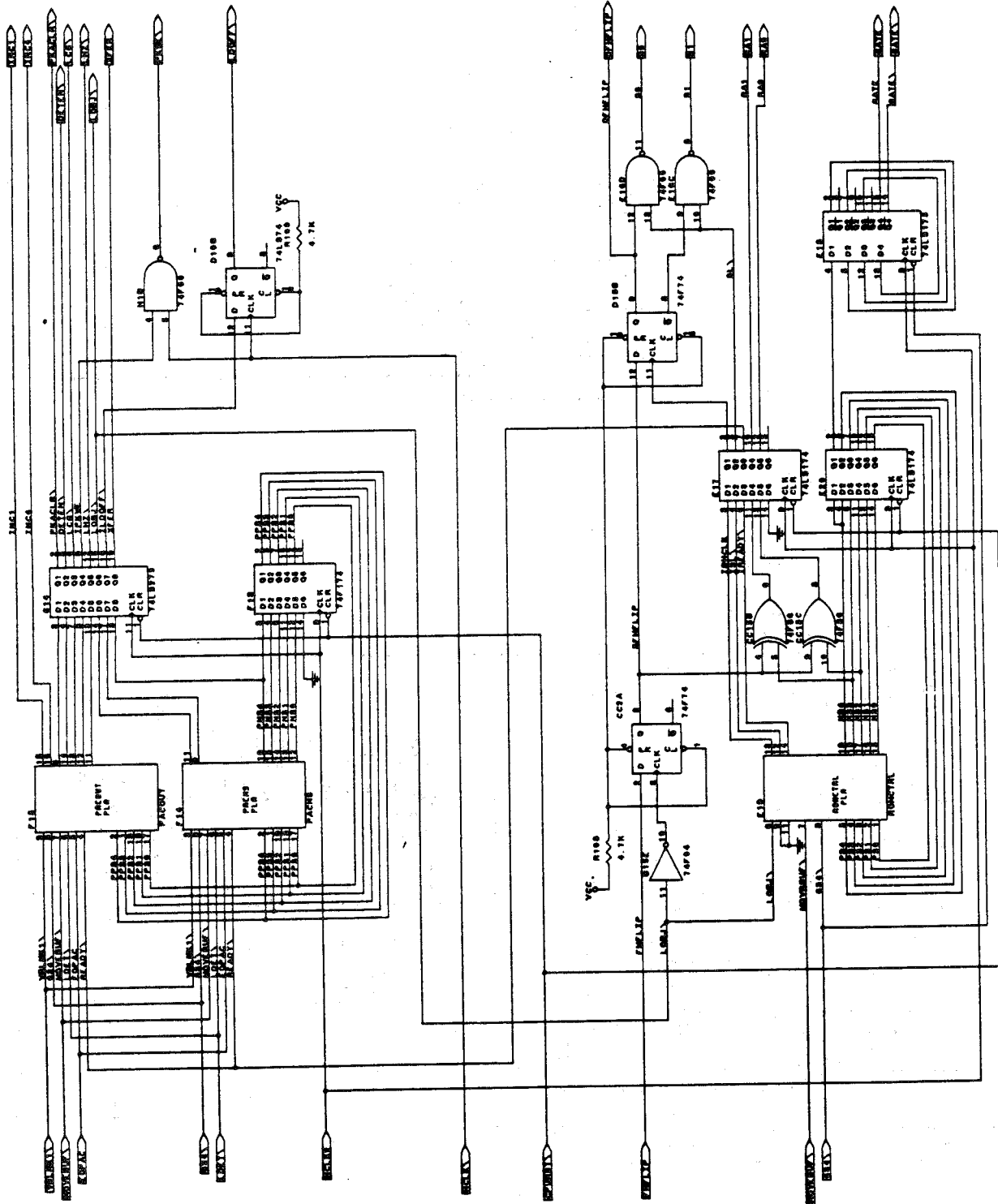

CPU Schematic Sheet 9 of 12

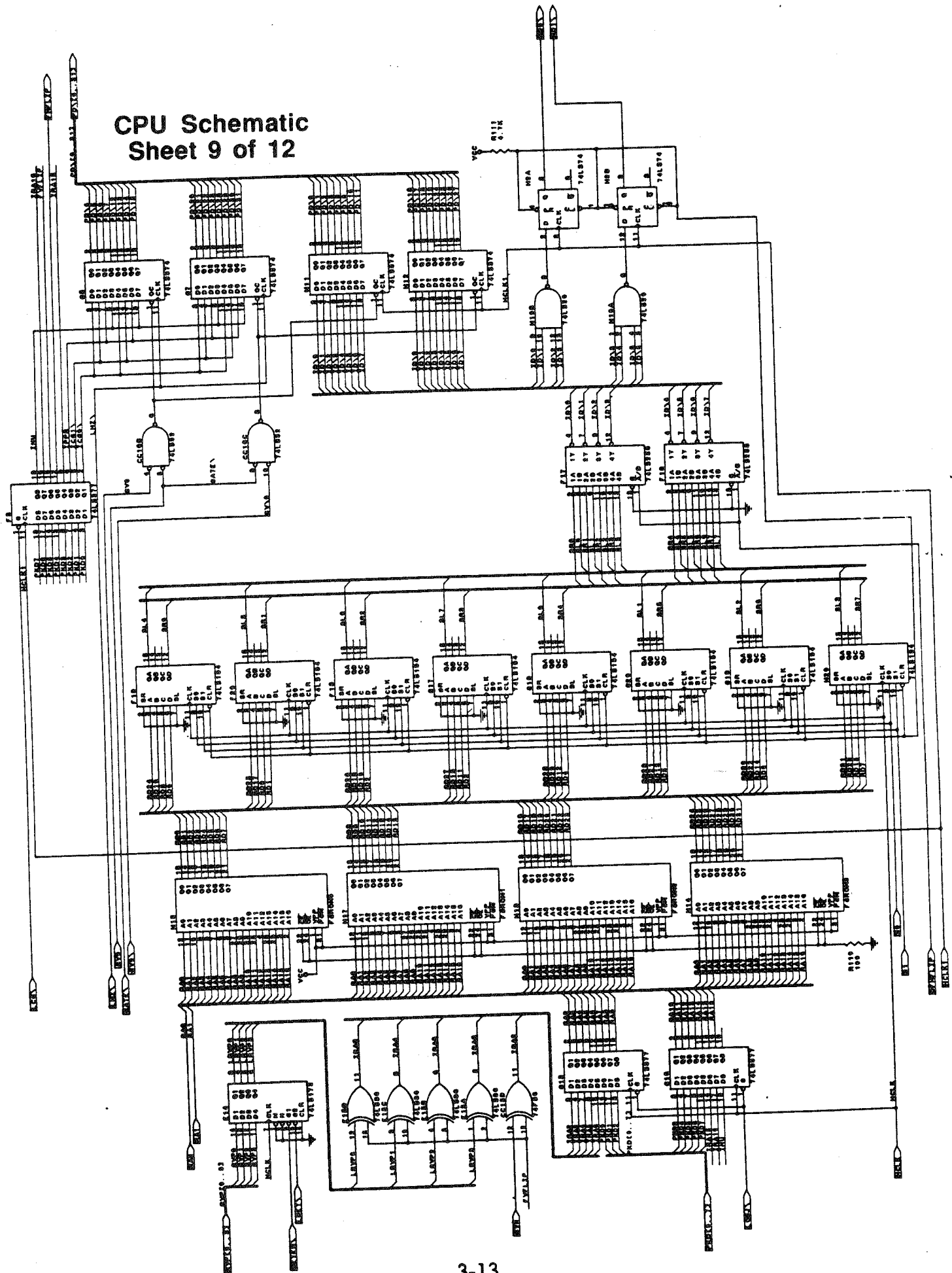

CPU Schematic Sheet 10 of 12

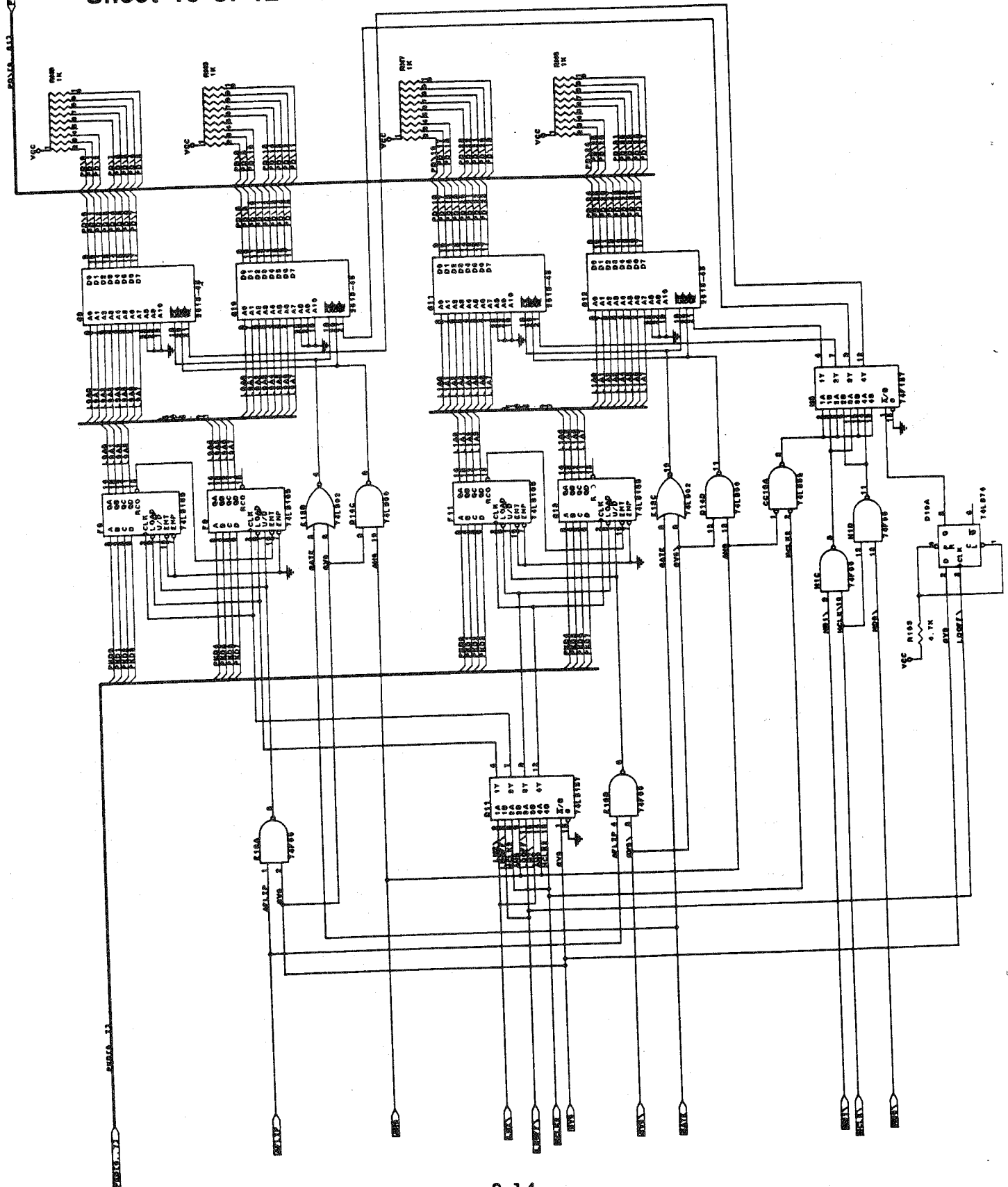

CPU Schematic
Sheet 11 of 12

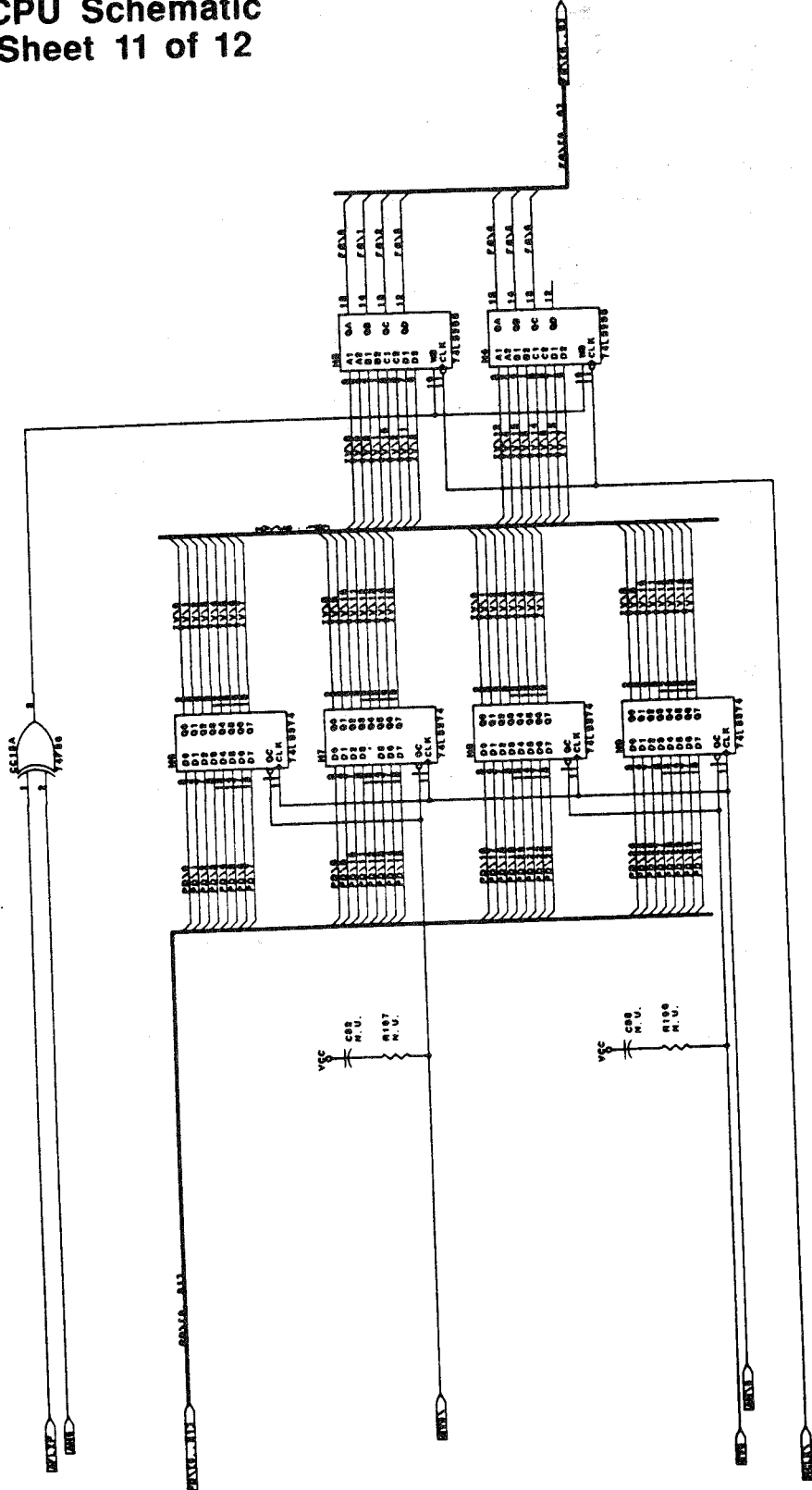

CPU Schematic

Sheet 12 of 12

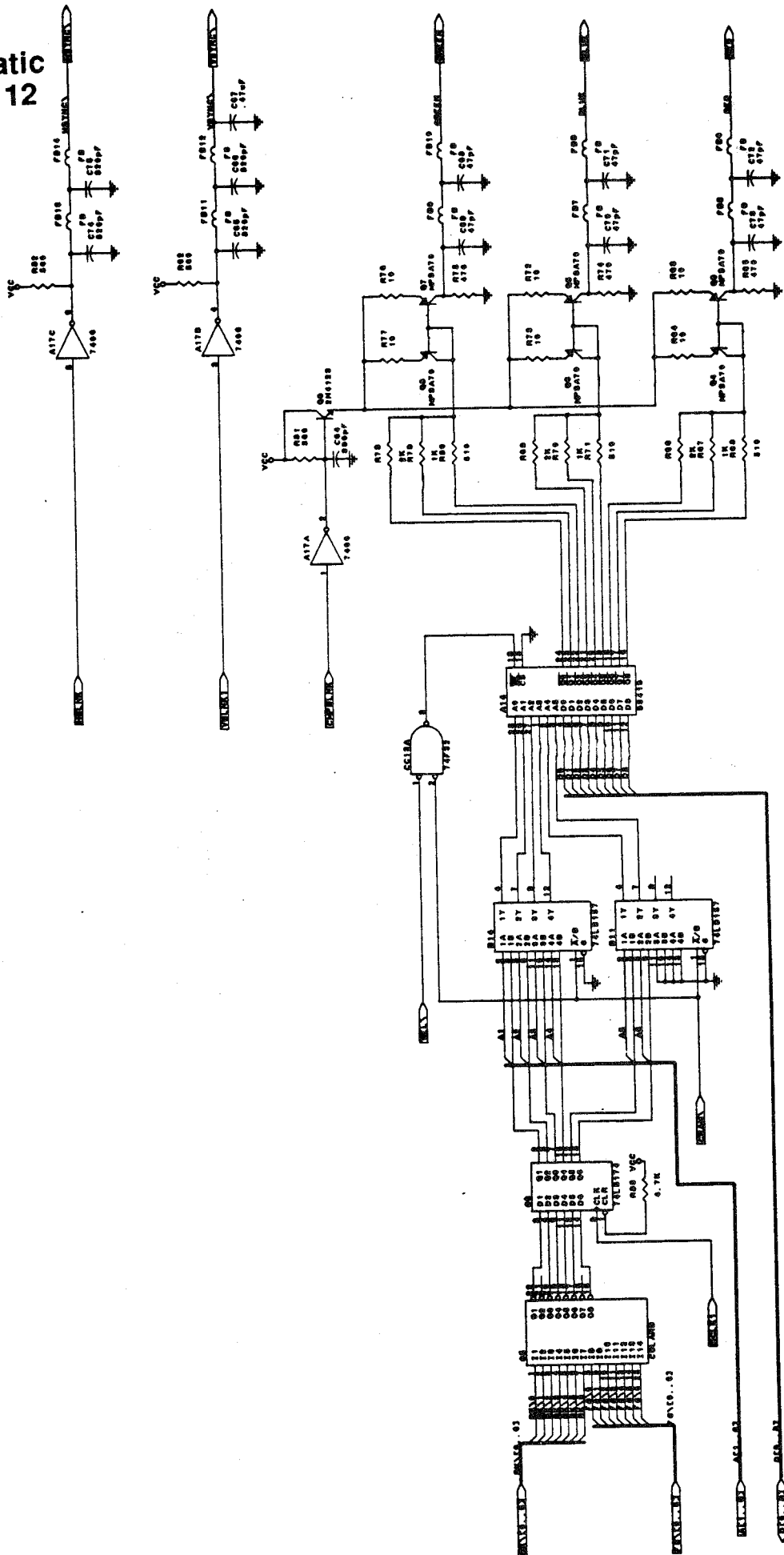

PIGSKIN INTERBOARD WIRING

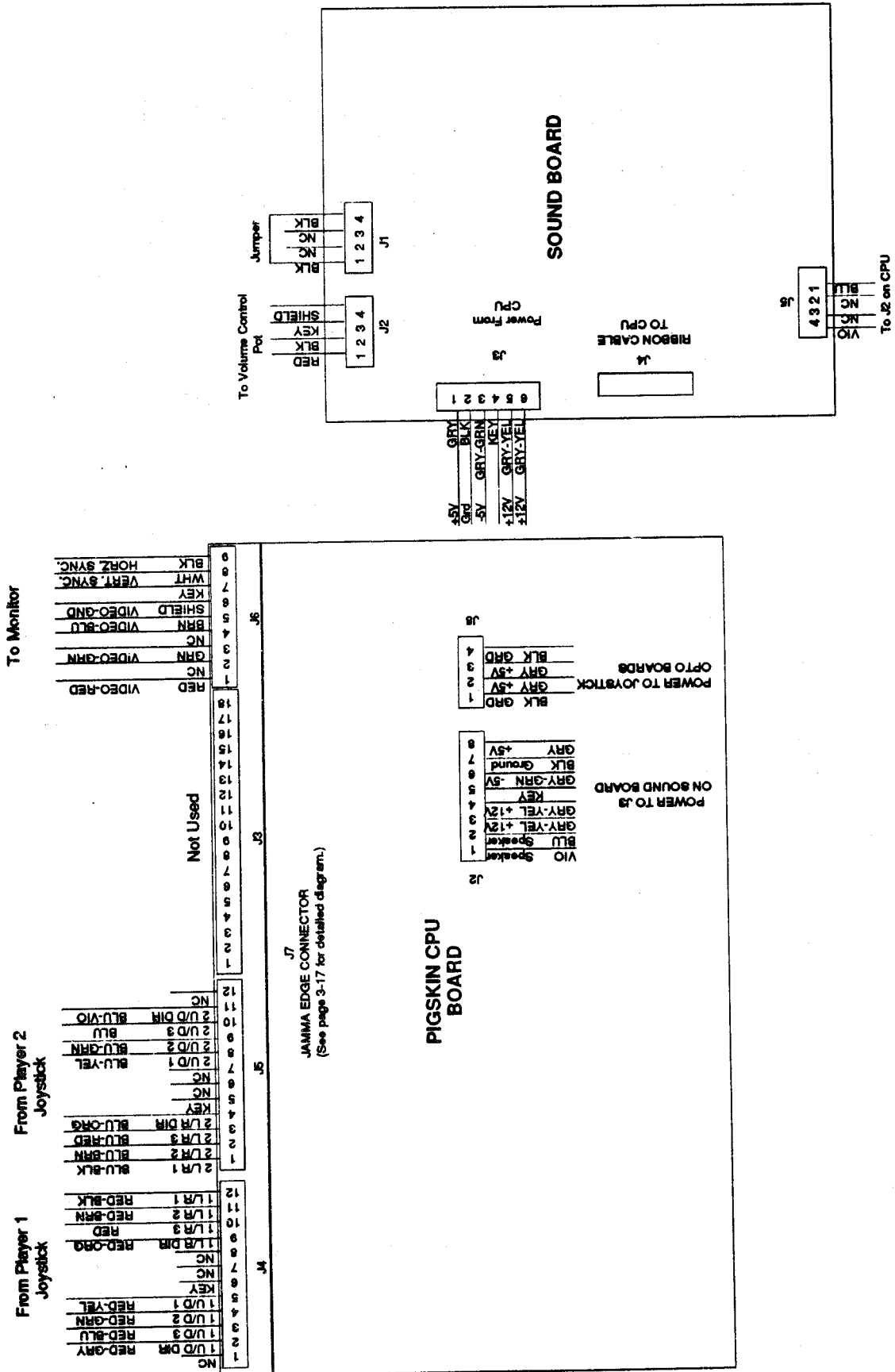

PIGSKIN Wiring Diagram

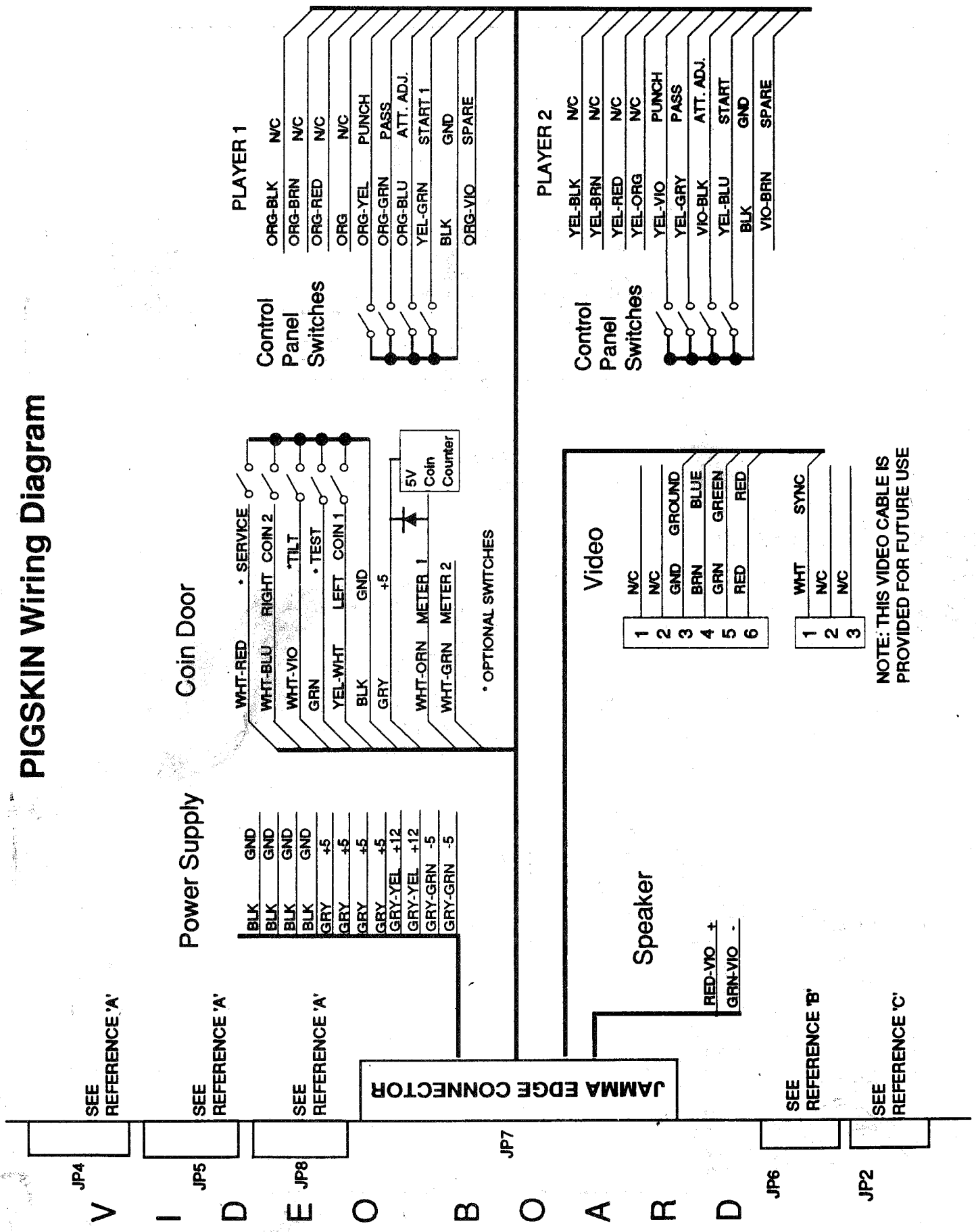

NOTE: THIS VIDEO CABLE IS PROVIDED FOR FUTURE USE

REFERENCE 'B'

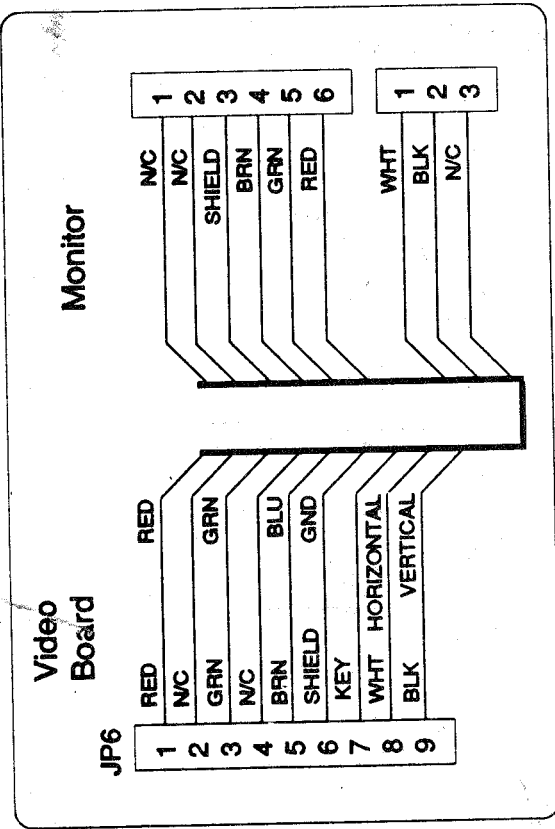

REFERENCE 'C'

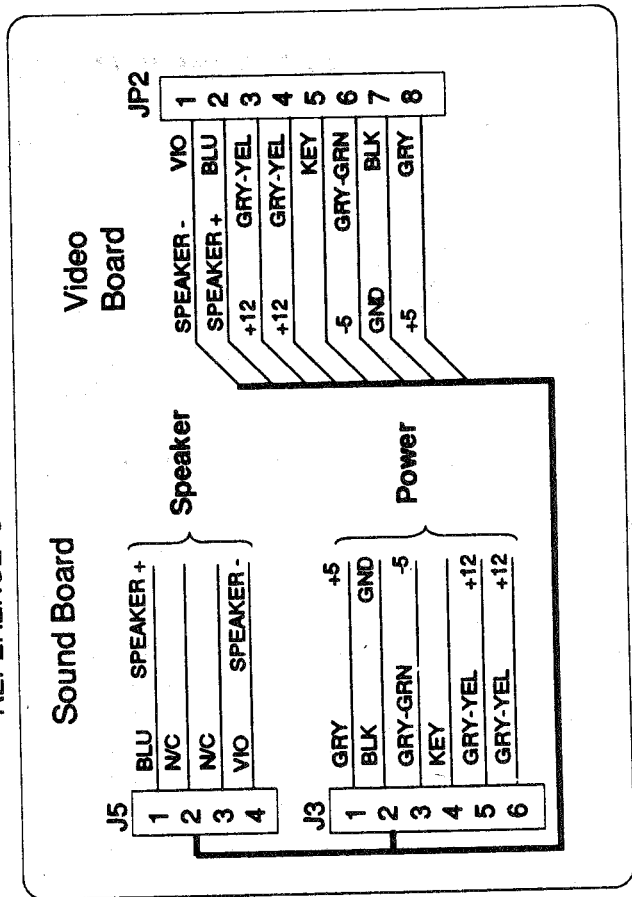

REFERENCE 'A'

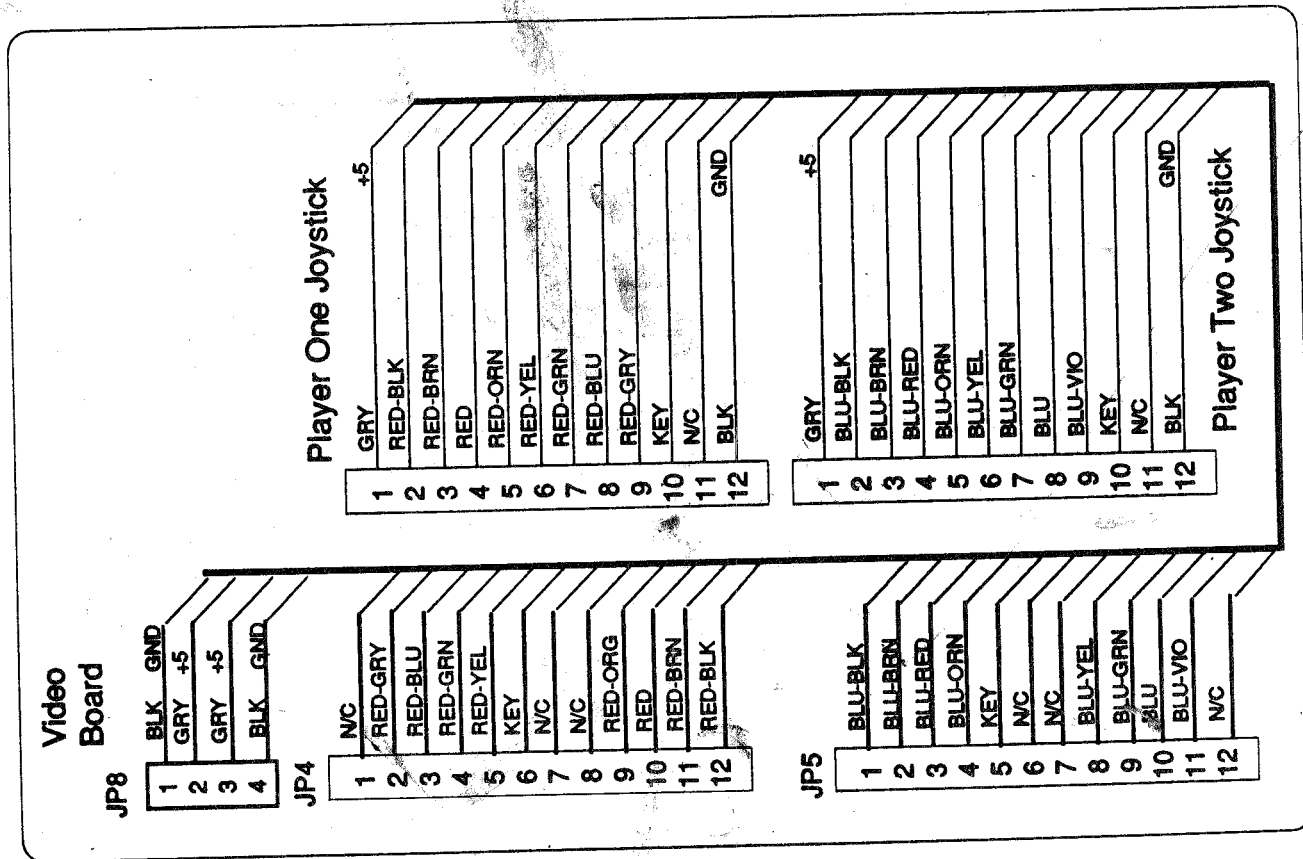

Coin Switch and Meter Wiring

Option 1

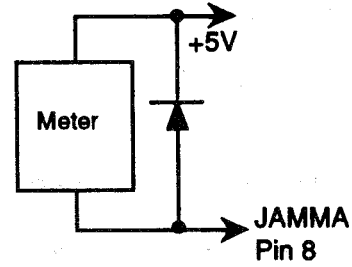
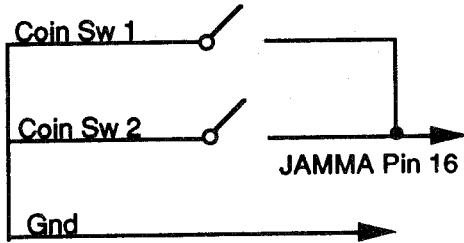

Option 2

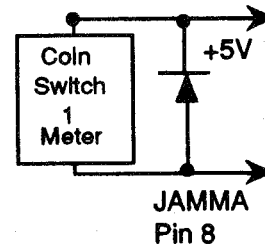
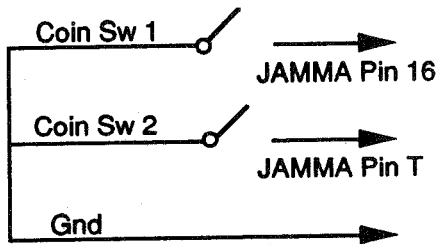

Wrong Way !

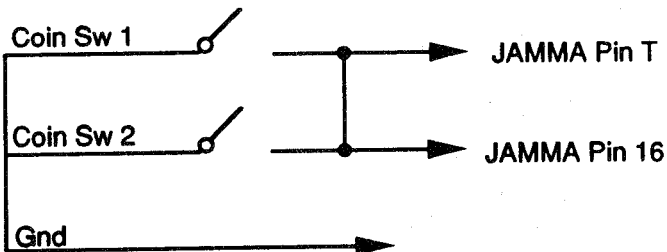

Do NOT Connect the coin switches this way. This Circuit is INCORRECT and will cause twice as many credits per coin.

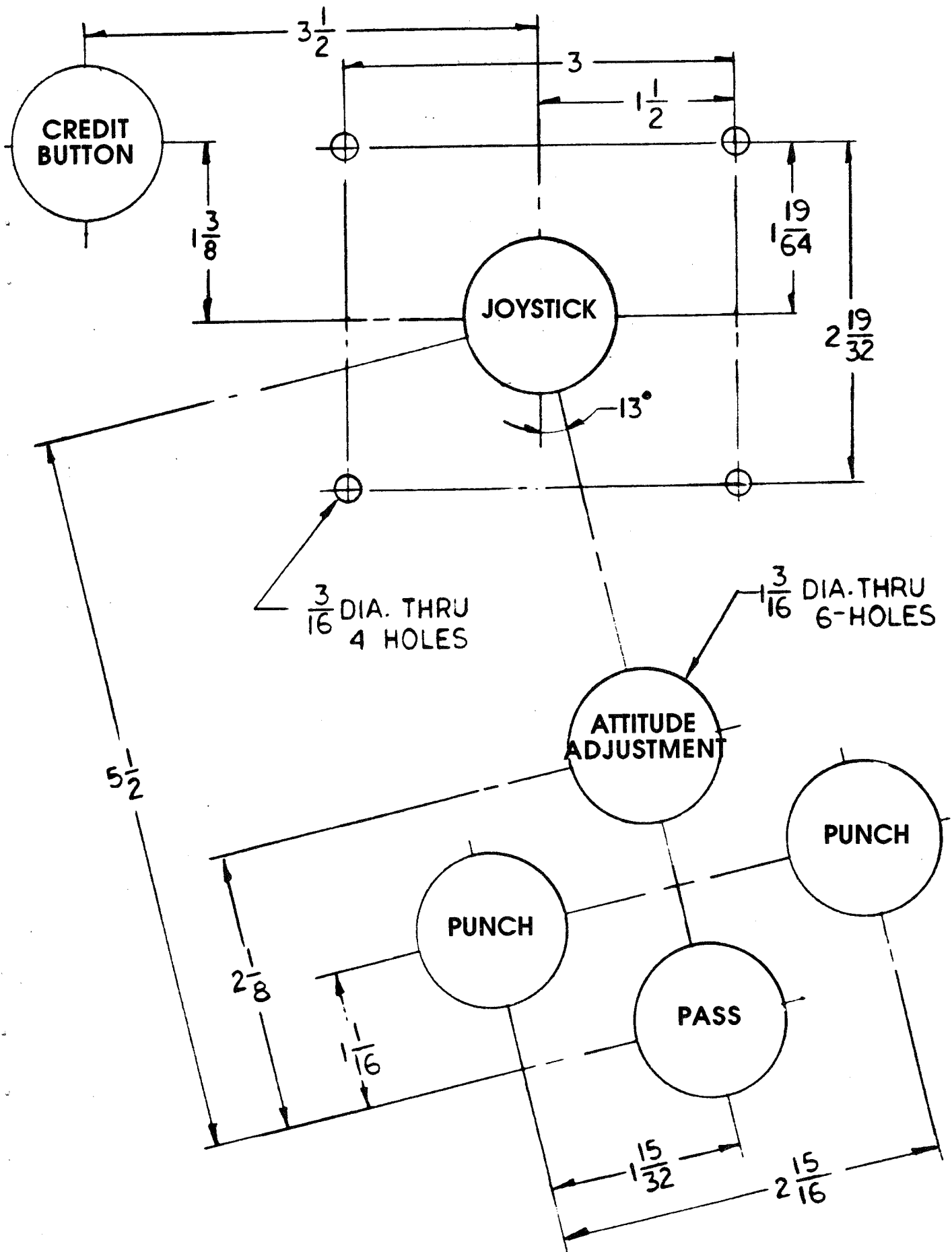

16-9155
 Control Panel Template
 Diagram

Notes

PIGSKIN Inserted Jumpers

AUDIO BOARD
P/N D-11581-4004

W2
W9
W11

PIGSKIN CPU BOARD
P/N C-13246-4004

W1
W2
W3
W6
W9
W10
W13

WARNINGS & NOTICES

Warning

USE OF NON-MIDWAY PARTS OR CIRCUIT MODIFICATIONS MAY CAUSE SERIOUS INJURY OR EQUIPMENT DAMAGE! USE ONLY MIDWAY AUTHORIZED PARTS.

- * For safety and reliability, substitute parts and modifications are not recommended.
- * Substitute parts or modifications may void FCC type acceptance.
- * This game is protected by Federal copyright, trademark and patent laws.

Unauthorized modifications may be illegal under Federal law. This also applies to Midway logos, designs, publications and assemblies. Moreover, facsimiles of Midway equipment (or any feature thereof) may be illegal under federal law, regardless of whether or not such facsimiles are manufactured with Midway components.

Warning

This equipment generates, uses and can emit radio frequency energy and, if not installed properly and used according to the directions in this manual, may cause interference to radio communications. It has been tested and found to comply with the limits for a Class A computing device pursuant to Subpart J of part 15 of FCC rules which are designed to provide reasonable protection against such interference when operated in a commercial environment. Operation of this equipment in a residential area is likely to cause interference to radio communications, in which the user, at his or her own expense, will be required to take whatever measures may be needed to correct the interference.

Warning

Prevent shock hazard and assure proper game operation. Only plug this game into a properly grounded outlet. Do not use a cheater plug to defeat the power cord's grounding pin. Do not cut off the ground pin.

Notice

No part of this publication may be reproduced by any mechanical, photographic, or electronic process, or in the form of a phonographic recording, nor may be transmitted, or otherwise copied for public or private use, without permission from the publisher.

**MIDWAY MANUFACTURING COMPANY
3401 N. CALIFORNIA AVE.
CHICAGO, ILLINOIS 60618**