

DEFIANT FIGHTER™

© CAPCOM CO., LTD. 1996 ALL RIGHTS RESERVED
© CAPCOM U.S.A., INC. 1996 ALL RIGHTS RESERVED

OPERATORS MANUAL



WARNING

This game is for use in the United States of America and Canada. Sales, export or operation outside of these countries may be constructed as copyright and trademark infringements and is strictly prohibited. Violators are subject to severe penalties and will be prosecuted to the full extent of the law.

CAPCOM® COIN-OP, INC.
3311 N. Kennicott Avenue
Arlington Heights, Illinois 60004
Phone: (847) 797-6100
Fax: (847) 797-6306

PM00164-KIT
022797

THANK YOU FOR PURCHASING *PUZZLE FIGHTER™*. WE INVITE YOU TO USE THE FOLLOWING MAILING ADDRESS, TELEPHONE OR FAX NUMBER FOR PARTS OR SERVICE INFORMATION CONCERNING THIS GAME:

CAPCOM® COIN-OP, INC.
ATTN: FIELD SERVICE - VIDEO PRODUCTS
3311 N. KENNICOTT AVENUE
ARLINGTON HEIGHTS, ILLINOIS 60004
PHONE: (847) 797-6100
FAX: (847) 797-6306

THE SERIAL NUMBERS OF YOUR KIT ARE LOCATED ON THE GAME CARTRIDGES AS SHOWN BELOW. PLEASE HAVE THESE SERIAL NUMBERS AVAILABLE WHEN CONTACTING US FOR SERVICE INFORMATION.

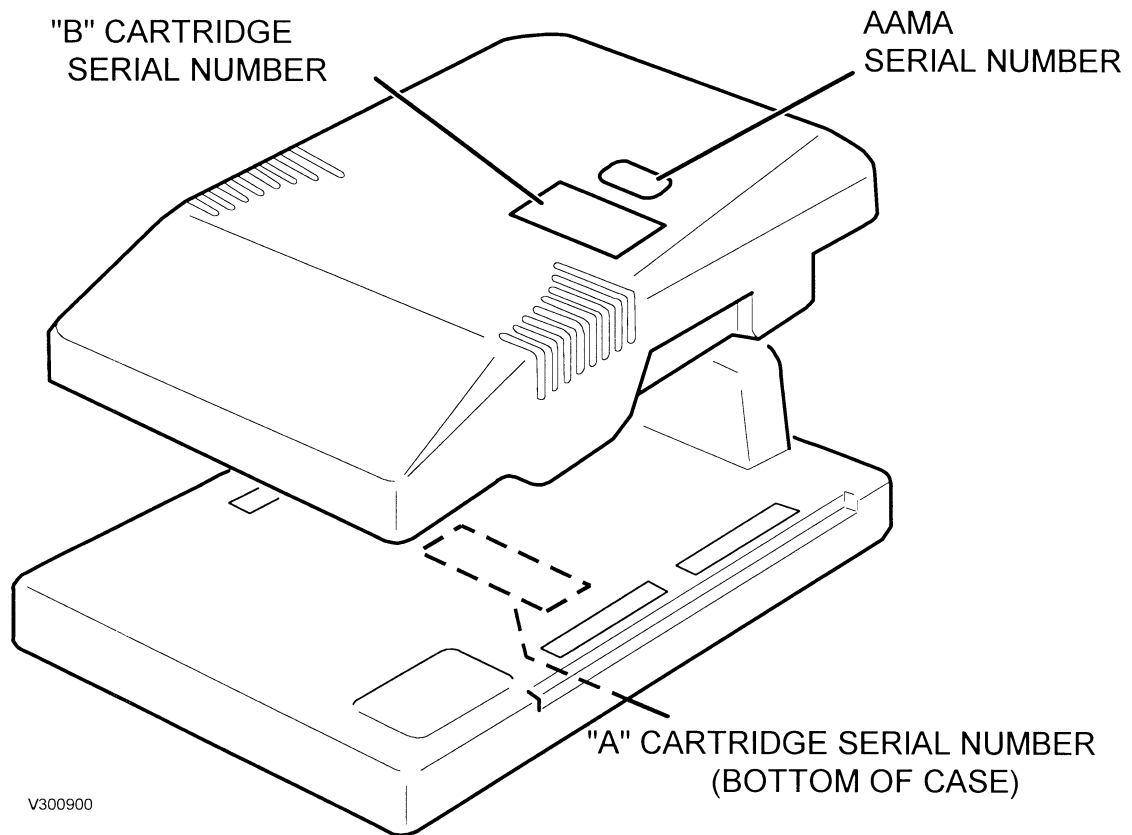

DEPENDING ON THE TYPE OF KIT YOU PURCHASED, PLEASE RECORD THE SERIAL NUMBERS HERE:

"FULL" KIT A-CARTRIDGE SERIAL # _____
 B-CARTRIDGE SERIAL # _____
 AAMA SERIAL # _____

TABLE OF CONTENTS

<i>Warranty Information</i>	ii
<i>Kit Inspection</i>	1
<i>Caution</i>	2
“FULL” Kit , “B” Kit		
Cabinet Preparation	3
Kit Installation	4
Control Panel Overlay	4
Reassembly of Components	5,6
Remote Volume/Test Switch	6
Control Panel Wiring	6,7
Cabinet Graphics	7
Game Cartridges	8
<i>Test Mode</i>		
Test Menu	9
Accessing the Menu	9
How to Select an Item	9
Closing the Menu	9
Menu Item Descriptions	10
.....Configuration Menu	11
System Configuration	12
Game Configuration	13
<i>Wiring References</i>		
JAMMA Connections	14
Auxiliary Cable Connections	14
<i>Template : “Full-Kit” Control Panel Drill Hole(s)</i>		
<i>Template : “B-Kit” Control Panel Drill Hole(s)</i>		

LIMITED PRODUCT WARRANTY (APPLIES TO DOMESTIC SALES ONLY)

CAPCOM® COIN-OP, INC. (Seller), warrants only to the initial purchaser of its products, that the items listed below are free from defects in material and workmanship under normal use and service for the warranty periods specified:

- A. CPS II System Cartridges One (1) Year
- B. Electronic and Mechanical Components: (90) days

No other part of Seller's products are warranted.

Warranty periods are effective from the initial date of shipment from seller to its authorized distributors.

Seller's sole liability shall be, at its option, to repair or replace products which are returned to Seller during the warranty periods specified, provided:

- A. Seller is notified promptly upon discovery by buyer that stated products are defective;
- B. Such products are properly packaged and then returned, prepaid to Seller's designated plant.

This warranty does not apply to any parts damaged during shipment or handling, or due to improper installation or usage, or alteration. In no event shall Seller be liable for any anticipated profits, loss of profits, loss of use, incidental or consequential damages or any other losses incurred by the customer in connection with the purchase of a CAPCOM® COIN-OP, INC. product.

WARRANTY DISCLAIMER

EXCEPT AS SPECIFICALLY PROVIDED IN A WRITTEN CONTRACT BETWEEN SELLER AND PURCHASER, THERE ARE NO OTHER WARRANTIES, EXPRESSED OR IMPLIED, INCLUDING ANY IMPLIED WARRANTIES OF MERCHANTABILITY OR FITNESS FOR A PARTICULAR PURPOSE.

IMPORTANT NOTICE

THIS SHIPMENT HAS BEEN CAREFULLY INSPECTED AND PROPERLY PACKAGED BEFORE LEAVING THE FACTORY. WE CANNOT ASSUME RESPONSIBILITY FOR BREAKAGE THAT MAY OCCUR DURING TRANSPORTATION OF THE GAME. IF THIS GAME IS DAMAGED UPON RECEIPT FROM THE CARRIER, IMMEDIATELY NOTIFY THE CARRIER AND FILE A DAMAGE REPORT.

KIT INSPECTION

There are two kits available for conversion to *PUZZLE FIGHTER™* :

1) **PF1000** ("FULL" kit) contains the complete game cartridges, all necessary graphics, and replacement joysticks and button switches. The "FULL" kit is intended for conversion of most JAMMA-compatible, horizontal screen cabinets.

2) **PF1000B** ("B" kit) contains the game software cartridge (B-cartridge) and must also be installed to a current CAPCOM® System II game. It includes all the necessary game graphics for a cabinet conversion (marquee, control panel overlay, monitor card, etc.).

Check that all parts have been shipped with your kit. If any parts are missing, contact your distributor immediately.

KIT PARTS LIST

PF1000	PF1000B	PART NO.	DESCRIPTION	QTY
√		A-00717	CPS II System Cartridges (A/B)	1
	√	A-00718	CPS II System Cartridge (B)	1
√	√	GE1200	Monitor Card	1
√	√	AW00225	Marquee	1
√	√	AW00145-1	Overlay, Control Panel	1
√	√	AW00224	Decal, Joystick & Button Switches	1
√	√	AW00147	Decal, Cabinet Side	2
√	√	AW00226-01	Decal - Top, Instruction	1
√	√	AW00226-02	Decal - Btm., Instruction	1
√	√	PM00164-KIT	Manual, Operators	1
√		GE2010	Joystick, 4-way	2
√		16-0130	Switch, 1-Player Start Button (White)	1
√		16-0131	Switch, 2-Player Start Button (White)	1
√		GE2520	Switch, Button (Red/Blue)	2
√		03-0066	Cable, Auxiliary Volume/Test	1
√		03-0050	Bracket, Volume/Test	1
√		13-0066	Bracket, A-Cartridge Mounting	4
√		SC00104-05	Screw, Wood	4

CAUTION

Please read the following instructions to keep the PC board in good condition:

- ◆ Do not block the ventilation slots.
- ◆ Do not drop or bump the board.
- ◆ Do not spill any liquids on the case.
- ◆ Do not disassemble the case.

ATTENTION

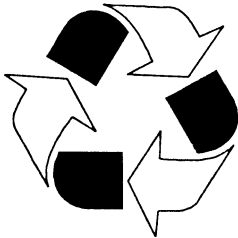

The product that you have purchased contains a recyclable battery. At the end of its useful life, under various state and local laws, it may be illegal to dispose of this battery into the municipal waste system. Check with your local solid waste official for details in your area for recycling options or proper disposal.

**DISASSEMBLING THE CASE OR REMOVING
THE STICKER MAY CAUSE THE TERMINATION
OF YOUR REPAIR WARRANTY.**

KIT INSTALLATION



WARNING:

MAKE SURE ELECTRICAL POWER TO THE GAME IS OFF BEFORE STARTING THE KIT INSTALLATION.

CABINET PREPARATION

“FULL” KIT

1. Disconnect and remove the old printed circuit board(s) from the cabinet.
2. Remove or open the control panel, and disconnect and remove the buttons and joystick(s) from the control panel.
3. Remove any covering from the control panel overlay, and then remove the control panel overlay.
4. Place the “Full-Kit” Drill Hole Template (included in this manual) over the control panel to determine proper hole locations. Center punch any needed new holes on the control panel.
5. Cut out the new holes using a 1-3/16" hole saw.
6. If there is an additional control panel cover (such as plastic or lexan) that will be utilized, cut any additional holes using the same template.
7. Plug-up unused holes with wood dowel (1-1/8" diameter), being careful to sand any rough edges. DO NOT use button plugs as they will cause an interference fit with the new dual-button switch included in this kit.
8. Remove the marquee covering, old marquee overlay, and the old cabinet graphics. Also, remove the monitor glass.

“B” KIT

1. Remove or open the control panel, and disconnect and remove all buttons and joystick(s) from the control panel.
2. Remove any covering from the control panel overlay, and then remove the control panel overlay.
3. Place the “B-Kit” Drill Hole Template (included in this manual) over the control panel to determine proper hole locations.
4. Plug-up unused holes with wood dowel (1-1/8" diameter), being careful to sand any rough edges, or use button plugs, if available.
5. Remove the marquee covering, old marquee overlay, and the old cabinet graphics. Also, remove the monitor glass.

INSTALLATION

CONTROL PANEL OVERLAY (SEE FIGURE 1, SEE FIGURE 2)

“FULL” KIT

9. The control panel overlay in the kit is oversized to accommodate most control panel sizes. Center the overlay on the control panel, leaving some excess material at the edges.

11. Remove the protective backing from the overlay and press it down on the control panel, keeping it properly aligned. Press it down firmly, smooth out any bubbles, and press it over the edges.

10. Trim any excess from the overlay. Again, place the “Full-Kit” Drill Hole Template on top of the overlay, aligning it with the joystick holes. Pierce through the overlay at each control panel hole. Then, cut away overlay material covering the joystick and button holes. Remove the template and clean off the overlay.

11. Peel off the backings of the joystick and button decals, align over the control panel holes, and press in place on the overlay. Using a knife, trim material from the center hole of the joystick decals.

12. Install the control panel cover (*if required).

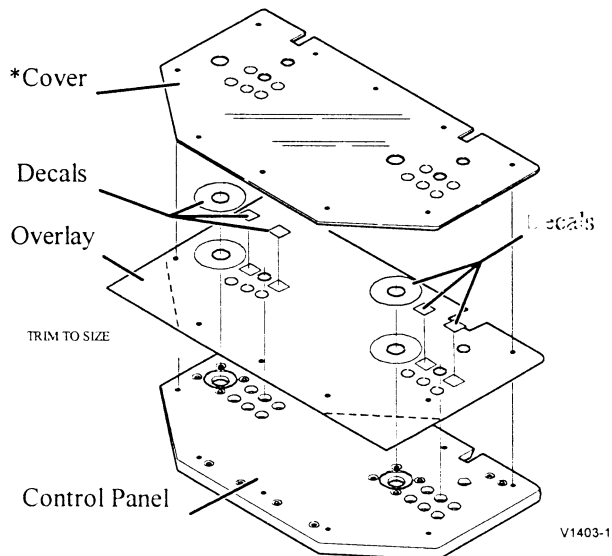

Figure 1: Overlay Installation (“FULL Kit”)

“B” KIT

6. The control panel overlay in the kit is oversized to accommodate most control panel sizes. Center the overlay on the control panel, leaving some excess material at the edges.

7. Remove the protective backing from the overlay and press it down on the control panel, keeping it properly aligned. Press it down firmly, smooth out any bubbles, and press it over the edges.

8. Trim any excess from the overlay. Again, place the “B-Kit” Drill Hole Template on top of the overlay, aligning it with the joystick holes. Pierce through the overlay at each control panel hole. Then, cut away overlay material covering the joystick and button holes. Remove the template and clean off the overlay.

9. Peel off the backings of the joystick and button decals, align over the control panel holes, and press in place on the overlay. Using a knife, trim material from the center hole of the joystick decals.

10. Install the control panel cover (*if required).

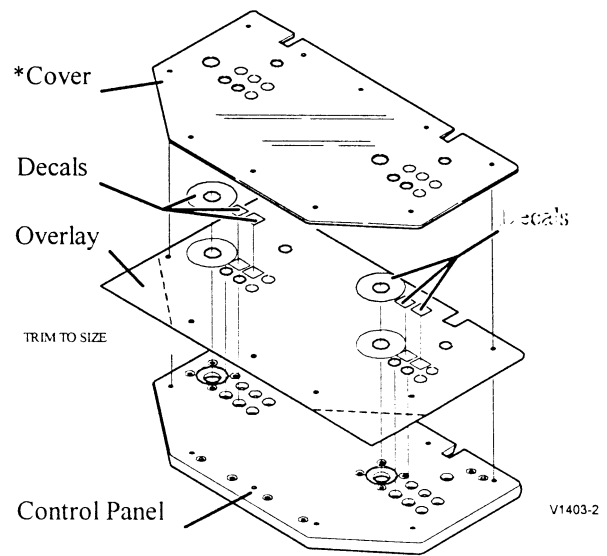

Figure 2: Overlay Installation (“B Kit”)

REASSEMBLY OF CONTROL PANEL COMPONENTS

“FULL” KIT

13. Install the dual-button switch and retaining ring to the control panel. Make sure that the button colors are orientated as shown in Figure 3.

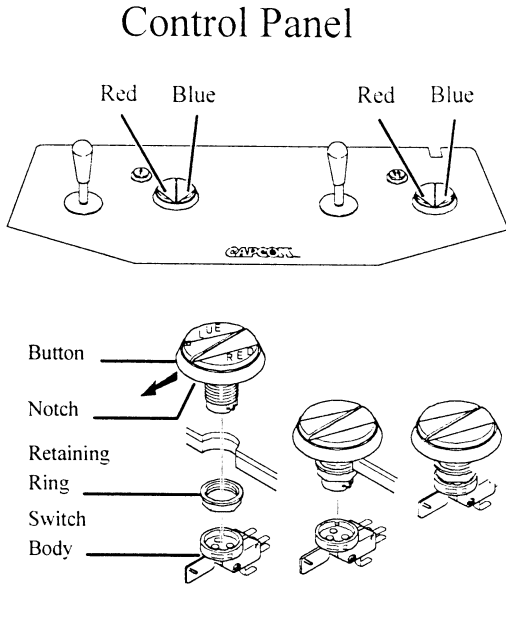

FIGURE 3 : Dual-Button Switch Installation (“Full” Kit)

14. When locate the new dual-button switch. Remove the switch body by twisting to the right and removing (see Figure 4). Also, remove the retaining ring.

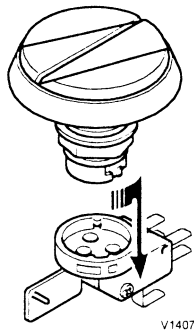

FIGURE 4 : Dual-Button Switch Removal

“B” KIT

11. Re-install all-buttons and retaining ring to the control panel!. Make sure that the button colors are orientated as shown in Figure 5.

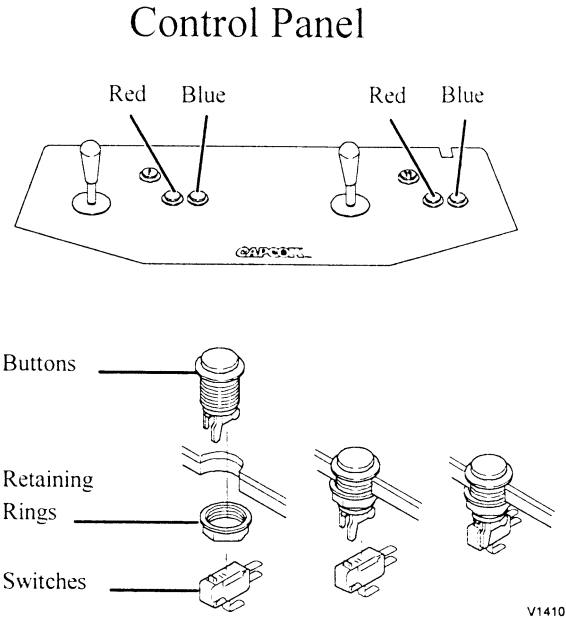

FIGURE 5 : Control Panel Buttons (“B” Kit)

12. Re-install all switches on the buttons as shown in Figure 2. Orient the switches so that when a button is pressed, the red contact on the switch is depressed.

“FULL” KIT

15. There are two white buttons include in the kit (See Figure 6.). Install the 1 PLAYER button & retaining ring to the top left-hand side of the control panel and the 2 PLAYER button & retaining ring to the top right-side of the control panel. These buttons function as the game start buttons.

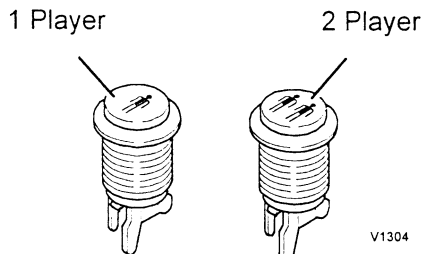

FIGURE 6: Start Buttons

16. Install all switches on the buttons as shown in Figure 3. Orient the switches so that when a button is pressed, the red contact on the switch is depressed.

17. Install the joysticks on the control panel as shown in Figure 7.

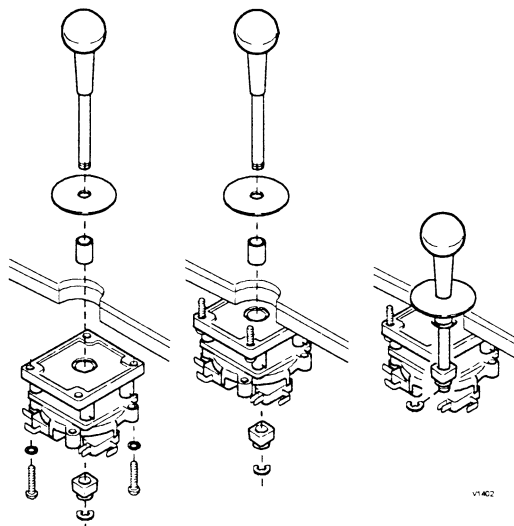

FIGURE 7: Joystick Installation

“FULL” KIT

CONTROL PANEL WIRING

NOTE: All switch wires used in this game must be wired to the normally-open connection on the switches. Each switch requires a ground wire on the common connector and the appropriate control or switch wire on the normally-open connector of the switch.

18. Reconnect the existing JAMMA connectors to the control panel according to the wiring connections shown in Table 1.

REMOTE VOLUME & TEST SWITCH

19. A remote Volume and Test switch bracket (see Figure 6) is included in this kit. Your cabinet may already contain this bracket. If you need to add the bracket to your cabinet, the bracket should be mounted inside the coin door and on top of the cash box for easy access.

NOTE: The A-cartridge also contains the same Volume and Test functions found on the remote switch bracket.

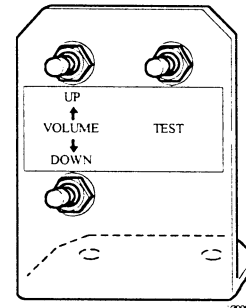

Figure 8: Switch Bracket

Wiring of the switch bracket (see Table 2) requires connections to both the main JAMMA harness as well as the auxiliary cable harness (refer to Figure 9).

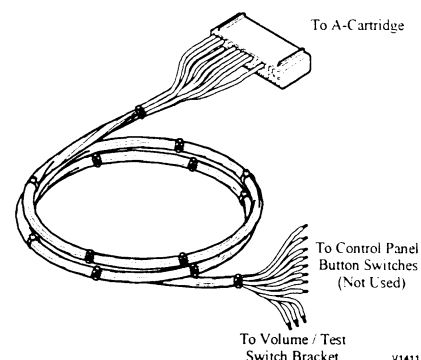

Figure 9: Auxiliary Cable Harness

JAMMA CONNECTOR REF.	*WIRE COLOR	CONNECTS TO	COMPONENT	FUNCTION
18	WHITE/BLACK	PLAYER 1	JOYSTICK	UP
19	WHITE/BROWN	PLAYER 1	JOYSTICK	DOWN
20	WHITE/RED	PLAYER 1	JOYSTICK	LEFT
21	WHITE/ORANGE	PLAYER 1	JOYSTICK	RIGHT
22	WHITE/YELLOW	PLAYER 1	BUTTON SWITCH	ROTATE LEFT
23	WHITE/GREEN	PLAYER 1	BUTTON SWITCH	ROTATE RIGHT
V	VIOLET/BLACK	PLAYER 2	JOYSTICK	UP
W	VIOLET/BROWN	PLAYER 2	JOYSTICK	DOWN
X	VIOLET/RED	PLAYER 2	JOYSTICK	LEFT
Y	VIOLET/ORANGE	PLAYER 2	JOYSTICK	RIGHT
Z	VIOLET/YELLOW	PLAYER 2	BUTTON SWITCH	ROTATE LEFT
a	VIOLET/GREEN	PLAYER 2	BUTTON SWITCH	ROTATE RIGHT

Table 1: Control Panel Wiring Connections (JAMMA)

*** Wire Color Note:** Wire colors shown are according to the AAMA -AMOA Standard for wire color assignments; your harness may contain different colors than shown above.

LEAD WIRE COLOR	SWITCH FUNCTION	CONNECTS TO
YELLOW	VOLUME-UP	AUX. CABLE '29'(GRAY / YELLOW)
GREEN	COMMON	AUX. CABLE '31'(BLACK / WHITE)
BLACK	VOLUME-DOWN	AUX. CABLE '30'(PINK / YELLOW)
GREEN	COMMON	AUX. CABLE '31'(BLACK / WHITE)
BROWN	TEST	JAMMA '15'
BLACK	GROUND	JAMMA 'A' or 'B' or 'e' or 'f' or '1' or '2' or '27' or '28'

Table 2: Switch Bracket Wiring

“FULL” KIT

20. Install the four (4) mounting brackets to the underside of the “A” cartridge as shown in Figure 10.

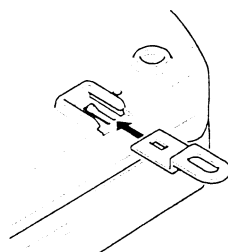

Figure 10: Mounting Bracket Installation

CABINET GRAPHICS INSTALLATION (Figure 13)

24. Install the new game marquee and re-install its' protective covering.

25. Peel-off the backing to the game instruction decals and place on both the top and the bottom sides of the monitor card. Also, apply the cabinet decals to both sides of the cabinet.

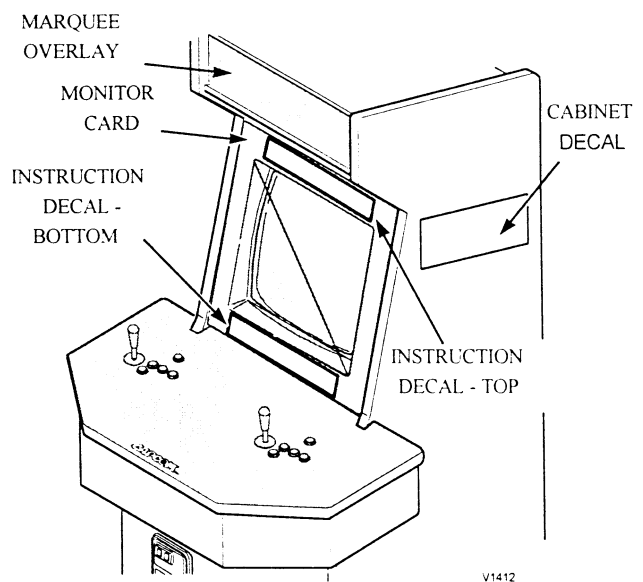
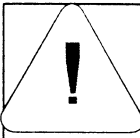



Figure 13: Cabinet Graphics



CAUTION

IMPROPER INSTALLATION OF THE JAMMA HARNESS TO THE GAME CARTRIDGE WILL CAUSE DAMAGE TO THE ENCLOSED PCB.



WARNING

DISASSEMBLY OF EITHER GAME CARTRIDGE WILL VOID YOUR WARRANTY.

GAME CARTRIDGE INSTALLATION

“FULL” KIT

21. Using the supplied wood screws, fasten the game cartridge case to the control panel shelf, as shown in Figure 11.

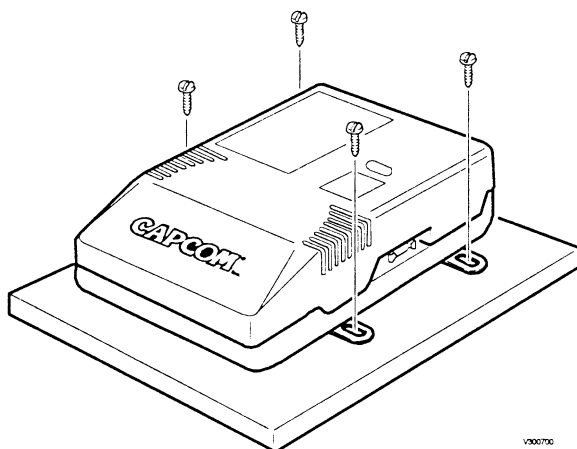

Figure 11: Case Mounting

22. Connect the JAMMA harness connector and the auxiliary cable connector to the “A” cartridge. If your cabinet is equipped with Q-SOUND, also attach the audio cables.

23. Power-up the game and set all operator adjustable options by pressing the **TEST** switch. Follow the instructions under the **TEST MENU** section of this manual.

“B” KIT

15. To remove the existing “B” cartridge from the “A” cartridge, pull the old case clamps apart (see Figure 12). Carefully remove the old “B” cartridge and install the new “B” cartridge. Re-install the case clamps.

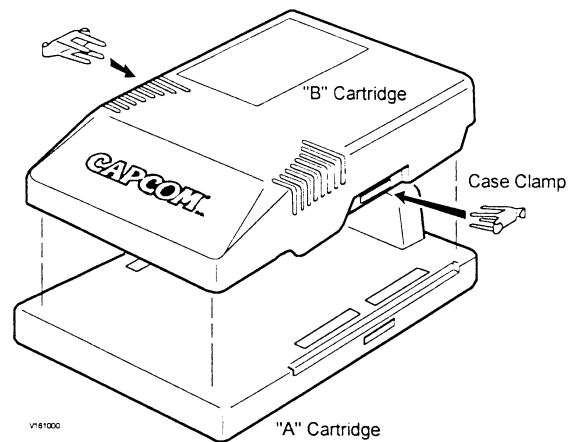

Figure 12 : Case Clamp Installation

16. Power-up the game and set all operator adjustable options by pressing the **TEST** switch. Follow the instructions under the **TEST MENU** section of this manual.

TEST MENU

The test menu allows you to test the functions and configure the game. These items include input devices such as joysticks, buttons and coin door or switches, output devices such as monitor, speakers and meters. Through the Test Menu you can also access the Configuration Menu, where you can change the settings of the game.

1. ACCESSING THE TEST MENU

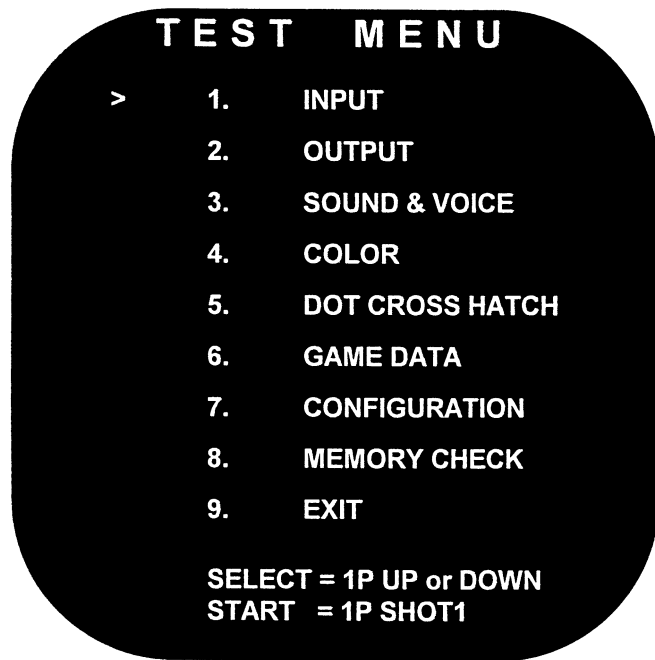

- **For a CAPCOM® cabinet, or a cabinet with a test switch:**
Make sure the game is on and push the test switch.
The screen shown left will appear.
- **For a cabinet without a test switch:**
Push the blue test switch on the outside of the black plastic casing.
Refer to the inside back cover of the manual.

2. HOW TO SELECT AN ITEM

- Use the *PLAYER 1 JOYSTICK* to move the arrow in front of the desired item and press the *PLAYER 1 SHOT 1* button, as shown below in various control panel configurations:

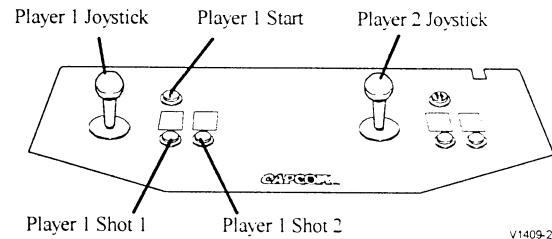
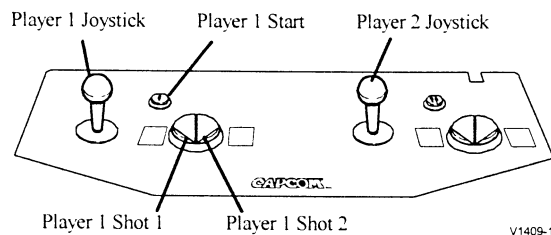

- To return to the test menu, push the *PLAYER 1 START* and *PLAYER 1 SHOT 1* buttons simultaneously.
- The test menu will always return to the screen:
 - a) After you exit the “7. CONFIGURATION MENU” and
 - b) After the memory is tested from the menu, “8. MEMORY CHECK”.

3. CLOSING THE TEST MENU

To close the Test Menu, highlight “9. EXIT” and push the *PLAYER 1 SHOT 1* button.

4. TEST MENU ITEM DESCRIPTIONS

INPUT	Used to test all the input switches, such as joysticks and buttons. The “0” changes to a “1” as the button is pushed or joystick is moved. Check connections and switches in case the “0” doesn’t change to a “1” when depressed or moved.
OUTPUT	Used to test the coin meter and the coin lock.
SOUND & VOICE	Select a code of SOUND or VOICE with the <i>PLAYER 1 JOYSTICK</i> . Push the <i>PLAYER 1 SHOT 1</i> button to hear the sound of the selected code.
COLOR	Shows color bars of red, green, blue, and white. Adjust RGB and brightness to obtain the optimum color balance and solid black background.
DOT CROSS HATCH	Used to test the screen size, focus and distortion.
GAME DATA	Coin meter and playtime information will be displayed.
CONFIGURATION	Used to change the game play settings. Refer to the CONFIGURATION MENU section.
MEMORY CHECK	Used to test memory. “OK” appears when each block of memory passes test, “NG” appears in case of malfunction. If “NG” appears, repeat the memory test and wait for the “OK” message. Contact your distributor if “NG” still appears.
EXIT	Select this item and push the <i>PLAYER 1 SHOT 1</i> button to return to game play mode.

CONFIGURATION MENU

The Configuration Menu is used to change various game settings such as level difficulty, credits, sound configuration, etc. These settings are stored in memory on the PCB.

The Configuration Menu is divided into 2 sections. In the **SYSTEM** section, you can change credits, sound, and coin door configurations. In the **GAME** section, you can change the play difficulty level and duration of the game.

7. CONFIGURATION MENU

- > 1. SYSTEM
- 2. GAME
- 3. DEFAULT
- 4. SAVE & EXIT

SELECT = 1P UP OR DOWN
 START = 1P SHOT1

1. ACCESSING THE CONFIGURATION MENU

- From the TEST MENU, move the arrow to “7. CONFIGURATION” and push the *PLAYER 1 SHOT 1* button. The screen left will be displayed. A description of each option is explained in the table below.

SYSTEM	Select this item to change settings for credits, monitor flip, sound and coin door configurations.
GAME	Select this item to change difficulty level, damage level, time count speed, maximum number of rounds and event type.
DEFAULT	Use this item to restore configuration settings to the original factory values. Press the <i>PLAYER 1 SHOT 1</i> and <i>PLAYER 1 SHOT 2</i> buttons at the same time to restore default values.
SAVE & EXIT	Use this to save new configuration settings and exit to the Test Menu. The message “SAVING NEW CONFIGURATION IN EEPROM” will appear while the new settings are being saved. DO NOT turn power off to the game until “SAVING” is complete and the Test Menu reappears.

SYSTEM CONFIGURATION

7-1. SYSTEM CONFIGURATION

- > 1. COIN MODE 1 COIN 1 CREDIT
- 2. CONTINUE ON
- 3. MONITOR NORMAL
- 4. DEMO SOUND ON
- 5. SOUND MODE STEREO (QSOUND)
- 6. CHUTE TYPE 2 CHUTES SINGLE
- 7. EXIT

SELECT OPTION = 1P UP OR DOWN
 MODIFY SETTING= 1P LEFT OR RIGHT
 = 1P SHOT1 OR SHOT2

CHANGING THE SYSTEM CONFIGURATION SETTINGS

Move the *PLAYER 1 JOYSTICK* up or down to highlight the desired option. Once the option is highlighted, move the *PLAYER 1 JOYSTICK* left or right or press the *PLAYER 1 SHOT 1* button to select.

SYSTEM CONFIGURATION ITEM DESCRIPTIONS

1. COIN MODE	SELECT THE CHARGE PER PLAY.
2. CONTINUE	SELECT ON FOR CONTINUOUS PLAY OR OFF FOR NON-CONTINUOUS PLAY.
3. MONITOR	FLIPS THE POSITION OF THE SCREEN. IF THE SCREEN APPEARS UPSIDE-DOWN, CHANGE THE SETTING TO FLIP ; IF THE SCREEN APPEARS CORRECT, SELECT NORMAL .
4. DEMO SOUND	TURNS ATTRACT SOUNDS ON OR OFF.
5. SOUND MODE	SELECT STEREO OR MONAURAL FOR USE WITH YOUR CABINET. NOTE: STEREO SHOULD ONLY BE SELECTED FOR USE WITH CAPCOM® QSOUND CABINETS.
6. CHUTE TYPE	SELECT THE NUMBER OF PLAYER(S) AND COIN CHUTE TYPE.
7. EXIT	TO SAVE THE SETTINGS AND RETURN TO THE CONFIGURATION MENU, HIGHLIGHT THIS ITEM AND PUSH EITHER THE <i>PLAYER 1 SHOT 1</i> BUTTON OR THE <i>PLAYER 1 SHOT 2</i> BUTTON.

SYSTEM CONFIGURATION OPTION SETTINGS

1. COIN MODE	1 COIN 1 CREDIT	1 COIN 2 CREDITS	1 COIN 3 CREDITS	1 COIN 4 CREDITS	1 COIN 5 CREDITS
	1 COIN 6 CREDITS	1 COIN 7 CREDITS	1 COIN 8 CREDITS	1 COIN 9 CREDITS	2 COINS 1 CREDIT
	3 COINS 1 CREDIT	4 COINS 1 CREDIT	5 COINS 1 CREDIT	6 COINS 1 CREDIT	7 COINS 1 CREDIT
	8 COINS 1 CREDIT	9 COINS 1 CREDIT	2 COINS START 1 COIN CONTINUE	FREE PLAY	
2. CONTINUE	ON			OFF	
3. MONITOR	NORMAL			FLIP	
4. DEMO SOUND	ON			OFF	
5. SOUND MODE	STEREO (Q SOUND)			MONAURAL	
6. CHUTE TYPE	2 CHUTES SINGLE	2 CHUTES MULTI		1 CHUTE SINGLE	

NOTE: **FACTORY SETTING**

GAME CONFIGURATION

7-2. GAME CONFIGURATION

- > 1. DIFFICULTY MEDIUM HARD
 - 2. DAMAGE LEVEL NORMAL
 - 3. GAME SPEED FASTEST
 - 4. GAME MODE TYPE A
 - 5. 1P MAX ROUND 1
 - 6. 2P MAX ROUND 1
 - 7. JOIN-IN ON
 - 8. HANDICAP OFF
 - 9. EXIT
- SELECT OPTION = 1P UP OR DOWN
 MODIFY SETTINGS = 1P LEFT OR RIGHT
 1P SHOT1 OR SHOT2

CHANGING THE GAME CONFIGURATION SETTINGS

Move the *PLAYER 1 JOYSTICK* up or down to highlight the desired option. Once the option is highlighted, move the *PLAYER 1 JOYSTICK* left or right or press the *PLAYER 1 SHOT 1* button to select.

ITEM	DESCRIPTION	OPTION SETTINGS			
1. DIFFICULTY	SETS THE GAME DIFFICULTY LEVEL	EASIEST	VERY EASY	EASY	MEDIUM
		MEDIUM HARD	HARD	VERY HARD	HARDEST
2. DAMAGE LEVEL	SETS THE NUMBER OF COUNTER GEMS. THE HIGHER THE LEVEL, THE MORE COUNTER GEMS APPEAR ON THE OPPONENT'S FIELD.	LOW	NORMAL	HIGH	MAXIMUM
3. GAME SPEED	SETS THE SPEED AT WHICH THE COUNTER GEMS DROP.	SLOW	NORMAL	FAST	FASTEST
4. GAME MODE	SET GAME PLAY OPTIONS:	TYPE A (STANDARD)	TYPE B	TYPE C	TYPE D (MATCH MODE)
<p>TYPE A: •DURING 1 CREDIT GAME: PLAYER'S OPPONENT IS "VS CPU". <i>JOIN-IN</i> ROUND IS PLAYED "VS CPU". <i>CONTINUE</i> IS ENABLED.</p> <p>TYPE B: •DURING 2+ CREDIT GAMES: <i>JOIN-IN</i> ROUND IS PLAYED "VS HUMAN".</p> <p>TYPE C: •DURING 1 OR MORE CREDIT GAME(S): PLAYER CAN CHOOSE BETWEEN "VS HUMAN" OR "VS CPU" OPPONENTS. <i>JOIN-IN</i> ROUND IS PLAYED "VS CPU". <i>CONTINUE</i> IS ENABLED.</p> <p>TYPE D: •DURING 1 OR MORE CREDIT GAME(S): - PLAYER'S OPPONENT IS "VS HUMAN". <i>JOIN-IN</i> AND <i>CONTINUE</i> ARE NOT AVAILABLE: THE GAME ENDS AFTER ONE MATCH IRRESPECTLESS OF THE RESULT.</p>					
5. 1P MAX ROUND	SETS THE NUMBER OF ROUNDS PER MATCH WHEN PLAYING "VS CPU". 1 ROUND: WINNER OF THE SINGLE ROUND WINS. 3 ROUNDS: WINNER OF 2 OUT OF 3 ROUNDS WINS. 5 ROUNDS: WINNER OF 3 OUT OF 5 ROUNDS WINS.	1 ROUND	3 ROUNDS	5 ROUNDS	
6. 2P MAX ROUND	SETS THE NUMBER OF ROUNDS PER MATCH WHEN PLAYING "VS PLAYER" (WINNER IS DETERMINED AS IN "#5" ABOVE).	1 ROUND	3 ROUNDS	5 ROUNDS	
7. JOIN-IN	"JOIN-IN" ALLOWS A SECOND PLAYER TO PARTICIPATE IN THE CURRENT GAME.	ON		OFF	
8. HANDICAP	ALLOWS EACH PLAYER TO SELECT BETWEEN EASY (1) TO HARD (5) GAME PLAY.	ON		OFF	
9. EXIT	RETURN TO THE CONFIGURATION MENU.				

NOTE: **FACTORY SETTING**

JAMMA CONNECTIONS

SOLDER SIDE			COMPONENT SIDE
GND	A	1	GND
GND	B	2	GND
+5 VDC	C	3	+5 VDC
+5 VDC	D	4	+5 VDC
N.C.	E	5	N.C.
+12 VDC	F	6	+12 VDC
KEY	H	7	KEY
N/C	J	8	COIN COUNTER 1
COIN LOCK 2	K	9	COIN LOCK 1
*SPEAKER (-)	L	10	*SPEAKER (+)
N.C.	M	11	N.C.
VIDEO GREEN	N	12	VIDEO RED
VIDEO SYNC	P	13	VIDEO BLUE
SERVICE (FREE CREDIT)	R	14	VIDEO GND
N/C	S	15	TEST MODE (DIAGNOSTICS)
2 PLAYER - COIN	T	16	1 PLAYER - COIN
2 PLAYER - START	U	17	1 PLAYER - START
2 PLAYER - JOYSTICK (UP)	V	18	1 PLAYER - JOYSTICK (UP)
2 PLAYER - JOYSTICK (DOWN)	W	19	1 PLAYER - JOYSTICK (DOWN)
2 PLAYER - JOYSTICK (LEFT)	X	20	1 PLAYER - JOYSTICK (LEFT)
2 PLAYER - JOYSTICK (RIGHT)	Y	21	1 PLAYER - JOYSTICK (RIGHT)
2 PLAYER - BUTTON (ROTATE LEFT)	Z	22	1 PLAYER - BUTTON (ROTATE LEFT)
2 PLAYER - BUTTON (ROTATE RIGHT)	a	23	1 PLAYER - BUTTON (ROTATE RIGHT)
N/C	b	24	N/C
N/C	c	25	N/C
N/C	d	26	N/C
GND	e	27	GND
GND	f	28	GND

*NOTE: FOR CABINETS EQUIPPED WITH CAPCOM® "Q" SOUND, AUDIO CONNECTIONS ARE MADE THROUGH THE A-CARTRIDGE WITH RCA-TYPE CONNECTORS.

AUXILIARY CABLE CONNECTIONS

WIRE COLOR	CONNECTOR ODD ROW			CONNECTOR EVEN ROW	WIRE COLOR
	N/C	1	2	N/C	
	N/C	3	4	N/C	
	N/C	5	6	N/C	
	N/C	7	8	N/C	
	N/C	9	10	N/C	
	N/C	11	12	N/C	
	N/C	13	14	N/C	
	N/C	15	16	N/C	
	N/C	17	18	N/C	
	N/C	19	20	N/C	
	N/C	21	22	N/C	
	N/C	23	24	N/C	
	N/C	25	26	N/C	
	N/C	27	28	N/C	
GRAY/YELLOW	TEST BRKT-VOLUME UP	29	30	TEST BRKT-VOLUME DOWN	PINK/YELLOW
BLACK/WHITE	TEST BRKT-VOLUME COMMON	31	32	N/C	
BLACK	N/C	33	34	N/C	BLACK

1-3/4" DRILL FOR
JOYSTICK HOLE

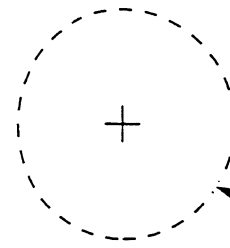
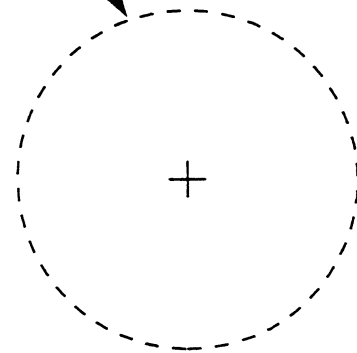

1-3/16" DRILL FOR
1P OR 2P START
BUTTON SWITCH

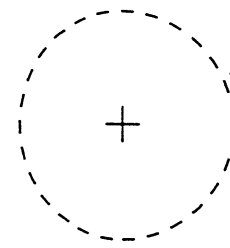

1-3/16" DRILL FOR
BUTTON SWITCH HOLE

CAPCOM[®]
COIN-OP, INC.

CAPCOM COIN-OP, INC.
3311 NORTH KENNICOTT AVENUE
ARLINGTON HEIGHTS, ILLINOIS 60004
PHONE (708) 797-6100
FAX (708) 797-6119

TITLE
"FULL-KIT" DRILL HOLE TEMPLATE:
SUPER PUZZLE FIGHTER II TURBO

DATE
6-25-96

DRAWN BY:
JA

V1406-1

REV.

1-3/4" DRILL FOR
JOYSTICK HOLE

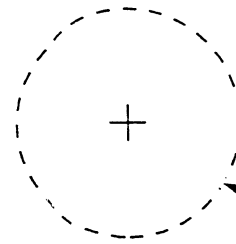
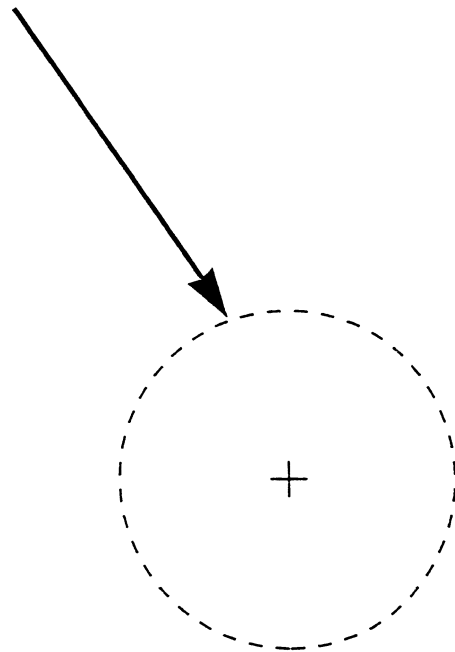

1-3/16" DRILL FOR
1P OR 2P START
BUTTON SWITCH

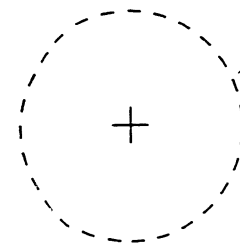
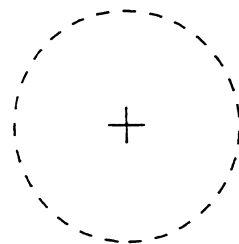

1-3/16" DRILL FOR
BUTTON SWITCH HOLES

CAPCOM [®] COIN-OP, INC.		CAPCOM COIN-OP, INC. 3311 NORTH KENNICOTT AVENUE ARLINGTON HEIGHTS, ILLINOIS 60004 PHONE (708) 797-6100 FAX (708) 797-6119	
TITLE "B-KIT" DRILL HOLE TEMPLATE: SUPER PUZZLE FIGHTER II TURBO			
DATE	6-25-96	DRAWN BY:	JA
	V1406-2	REV.	

REFERENCE INFORMATION

GAME CASE CONTROLS

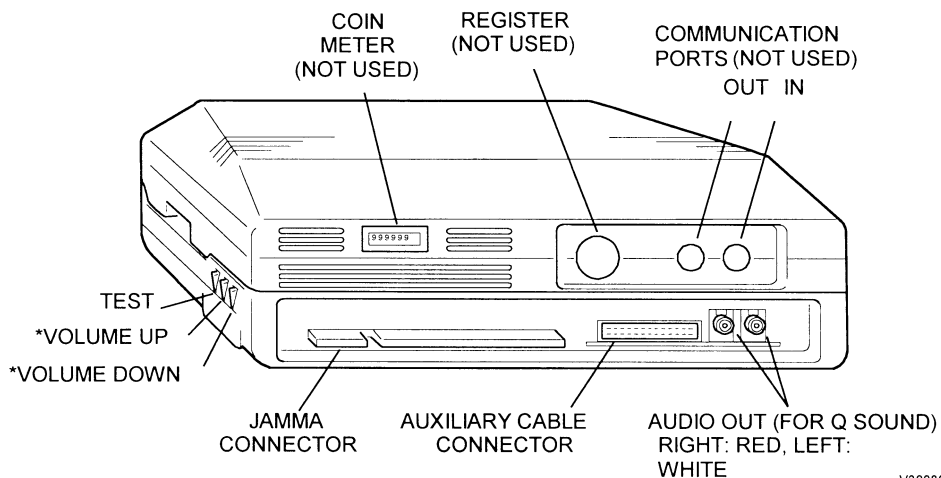

V300800

TYPICAL CONTROL PANEL LAYOUTS FOR PUZZLE FIGHTER™

“FULL-KIT”

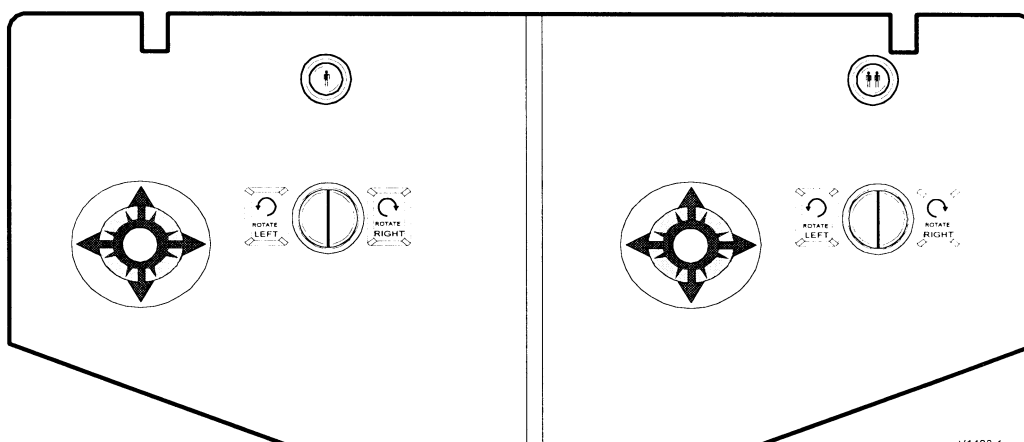

V1408 1

“B-KIT”

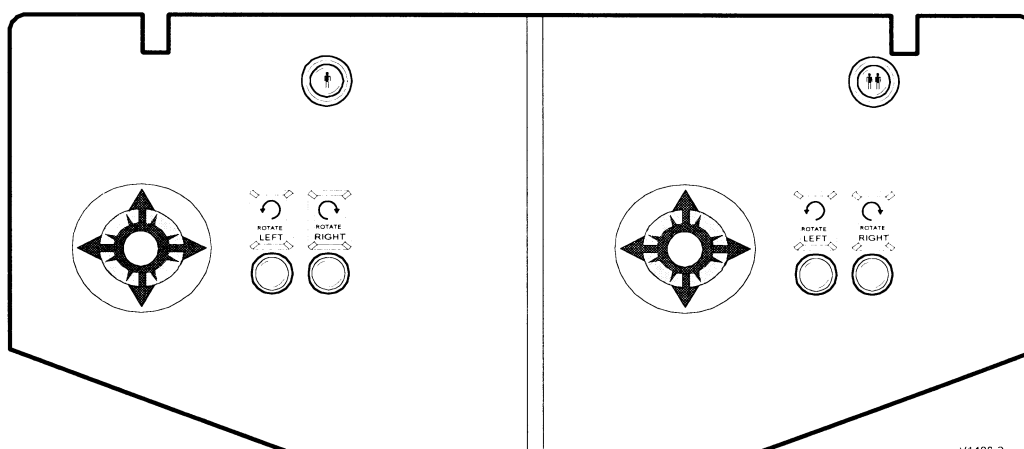

V1408 2

NOTICE

This equipment has been tested and found to comply with the limits for a Class A digital device, pursuant to Part 15 of the FCC Rules. These limits are designed to provide reasonable protection against harmful interference when the equipment is operated in a commercial environment. This equipment generates, uses, and can radiate radio frequency energy and, if not installed and used in accordance with the instruction manual, may cause harmful interference to radio communications. Operation of this equipment in a residential area is likely to cause harmful interference, in which case the user will be required to correct the interference at his own expense.

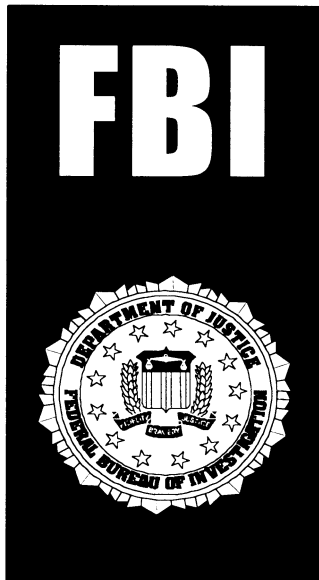

WARNING

Federal law provides severe civil and criminal penalties for the unauthorized reproduction, distribution, or exhibition of copyrighted audiovisual works and video games.

The Federal Bureau of Investigation investigates allegations of criminal copyright infringement.

CAPCOM[®] COIN-OP, INC.
3311 N. Kennicott Avenue
Arlington Heights, Illinois 60004
Phone: (847) 797-6100
Fax: (847) 797-6306