

**namco** America, Inc.

**SOUL EDGE**™

**Ver. II**

**KIT**  
**Installation Manual**

## **Important**

**Read PRECAUTIONS and INSTALLATION  
Sections before operating game**

## **FCC Notice**

Note: This equipment has been tested and found to comply with the limits for a Class A digital device, pursuant to Part 15 of the FCC Rules. These limits are designed to provide reasonable protection against harmful interference when the equipment is operating in a commercial environment. This equipment uses, and can radiate radio frequency energy and, if not installed and used in accordance with the instruction manual, may cause harmful interference to radio communications. Operation of this equipment in a residential area is likely to cause harmful interference in which case the user will be required to correct the interference at his own expense.

**Copyright 1996 NAMCO AMERICA INC. - All rights reserved**

No part of this publication may be reproduced by any mechanical photographic, or electronic process, or in the form of a phonographic recording, nor may it be stored in a retrieval system, transmitted, or otherwise copied for public or private use, without permission from NAMCO AMERICA INC.

**TABLE OF CONTENTS**

1.0 SPECIFICATIONS.....	1
1.1 GAME CONVERSION OVERVIEW.....	2
2.0 INTRODUCTION AND GAME PLAY.....	3
2.1 MAXIMIZING EARNINGS.....	5
3.0 INSTALLATION.....	5
3.1 PRECAUTIONS.....	5
3.2 CABINET PREPARATION.....	6
3.3 GAME INSTALLATION.....	6
3.4 CONTROL PANEL.....	7
3.5 CABINET GRAPHICS.....	7
4.0 SET-UP AND TEST.....	8
4.1 TEST MODE.....	8
4.2 TEST MODE PROCEDURE.....	8
4.3 TEST MENU.....	8
4.3.1 Switch Test Screen.....	9
4.3.2 Coin Options.....	10
4.3.3 Game Options.....	11
4.3.4 A.D.S. Screens.....	12
5.0 SOUND VOLUME ADJUSTMENTS.....	14
6.0 MONITOR ADJUSTMENTS.....	14
7.0 PCB CONNECTOR TABLES.....	15
7.1 JAMMA EDGE CONNECTOR.....	15
7.2 EXTENDED EDGE CONNECTOR.....	16
APPENDIX A: ILLUSTRATIONS and PARTS LIST	
APPENDIX B: WIRING DIAGRAM	

## 1.0 SPECIFICATIONS

### Conversion Game

Power Supply:	150 Watt computer-grade, providing +5 VDC +/- 5%, 5 Amp Minimum +12 VDC +/- 5%, 2 Amp Minimum
Harness:	56 pin JAMMA-Type, Key installed at pins H & 7.
Monitor:	Horizontally mounted color monitor, accepting RGB video inputs from kit PCB.

### Kit Specifications

Control panel: 2-Player configuration.

(2) 8-Way Joystick, black:	(1P, 2P, 1 each)
(2) Push-button switch, white:	(1P, 2P, 2 each)
(8) Push-button switch, yellow:	(1P, 2P, 4 each)

### **Marquee and Graphics Set**

#### **Kit Game PCB**

- (1) Namco System 11 SOUL EDGE PCB, w/ Foil Shield

#### **56-Pin Connector Harness**

#### **48 Pin Connector Harness**

- (1) DDK 225D-10024C2-2312 only

**! IMPORTANT NOTE !**

**The 48-pin connector supplied with the SOUL EDGE kit has  
a small pitch or distance between connection pads.  
DO NOT SUBSTITUTE OTHER 48 PIN CONNECTORS.**

**Note:** *Specifications subject to change without prior notice. Modification and/or alteration of the SOUL EDGE game kit with kits or parts not supplied by NAMCO may void the warranty.*

**REMOVAL OF SERIAL NUMBERS AND/OR BAR-CODES FROM PRODUCT OR  
COMPONENTS WILL VOID THE WARRANTY**

## **Kit Installation Manual**

---

### **1.1 GAME CONVERSION OVERVIEW**

The SOUL EDGE kit consists of the SOUL EDGE PCB set, a standard JAMMA (56 pin) wire harness, an extended JAMMA (48 pin) wire harness for stereo and extra controls, a set of player controls and SOUL EDGE graphics. This kit can be installed in an industry standard 25 or 27 inch color monitor kit cabinet. Optimum results are achieved by installing SOUL EDGE in a cabinet with stereo speakers and a large, 4 player size control panel.



TM

## Ver. II

### 2.0 INTRODUCTION AND GAME PLAY

SOUL EDGE VER. II is an update to the original game. The basic core game play remains the same. Look for the updated logo (two crossed swords w/"Ver. II") in the attract screen to guarantee which version you have. Additions and modifications make SOUL EDGE VER. II an even better game. SOUL EDGE VER. II is a new 2-player, 3-D polygon, weapons-based fighting game. Powered by Namco's System 11 hardware, players are treated to brilliant graphics featuring the most fluid graphics ever seen! New features "3-D Attack", "3-D Defense", "Locked Weapons", "Guard Impact" and "Critical Edge" will break new ground in fighting games. Players select from eight armed warriors from around the globe, each wielding their weapon of choice in pursuit of the ultimate weapon.

#### Increased Number of Characters

The original game featured a selection of eight characters. In Version II, Cervantes De Leon and Hwang Sung Kyung become selectable. All characters now have two different clothing colors. Select their original clothing colors by pressing button A. Select their new clothing colors with button B or K. If the G button is held down while pressing the A, B or K buttons, an optional clothing set can be selected.

#### Four Buttons Provide a Variety of Functions:

- **G - Guard:** Used in combination with the joystick, players can block a high, medium or low attack.
- **H - Horizontal Attack:** Used in combination with the joystick, characters perform a high, medium or low horizontal weapon attack.
- **V - Vertical Attack:** Used in combination with the joystick, characters perform a high, medium or low vertical weapon attack.
- **K - Kick:** Used in combination with the joystick, characters can kick high, medium or low.

## Kit Installation Manual

---

### 3-D Attack and 3-D Defense:

Once predicting an opponent attack, players can perform an evade move by side stepping left or right. This presents the defender with an attacking opportunity via a counter attack.

### Guard Impact:

By using the joystick and pressing the "guard" button precisely at the point of impact, players can momentarily knock loose their opponent's weapon, leaving him/her defenseless and vulnerable to an attack. Guard Impact works for all weapon attacks (upper, middle, lower), except jumping attacks. This is a modification of the original Guard Impact.

### Attacking from a "Locked Sword Position":

When two players perform the same attack on each other at the same time, the characters will lock their weapons for a brief moment. During this time, players must choose a follow-up horizontal, vertical or kick attack. When the weapons unlock, characters will each perform their commanded move.

### Critical Edge:

This move is a 3-button command that automatically executes a combination move. In exchange, the player sacrifices a loss of weapon strength. "Critical Edge" is composed of a first and second half combo. Once the combo begins, players must repeat the command to execute the second half combo. If the attack is "guarded" or avoided, the combo ends there. Whether the first hit lands or not, the same loss to the attacker's weapon gauge is registered. If a player's weapon gauge becomes emptied, his or her character will lose it's weapon. The player must fight hand to hand for the remainder of the round.

#### *"Critical Edge" enhancements in Ver. II:*

- The subtracted value on the Weapon Gauge when using Critical Edge has been reduced.
- Even after inputting Critical Edge, players may cancel the command by pressing the Guard button.
- Critical Edge can now be performed when back dashing.
- Critical Edge can now be performed on all opponents while they are in the air.

### Floating Combos:

This is a new feature added to Ver. II. All characters may now make "upswing attacks" on opponents who are in the air. Use the joystick in three positions (high, medium, low) and the B button for these attacks.

**Unblockable Attacks:**

All characters now have an unblockable attack in Ver. II. There was an inequity in the original version as some had an unblockable and some did not. This move can be cancelled by pressing the Guard button.

**Time Attack Mode:**

This is new to Ver. II. Players can test their skill against the computer. In the title screen, press the start button while holding down buttons A + B + K to enter "Time Attack." Players will fight opponents in the same order every time. When the player reaches the end, several game play statistics will appear to rate each player's skill.

Buy-in's are permitted even during "Time Attack". The challenged player must win the match in order to resume "Time Attack." If defeated, the player loses his/her place in the "Time Attack" and must restart this mode from the beginning.

**Throws:**

Throws in Ver. II are now easier to perform.

**2.1 MAXIMIZING EARNINGS**

To achieve optimum earnings it is recommended that you set the game to Namco's USA RECOMMENDED FACTORY SETTINGS. We believe that these settings are the most suitable for a wide variety of locations. These settings are not necessarily the same as the GREEN default settings in both the "Coin Options" and "Game Options" screens. However, as all locations are not alike, they are easily adjustable through the TEST MODE.

**3.0 INSTALLATION**

Note: Shipping damage may void the warranty. In case of shipping damage, contact your distributor and the transportation carrier immediately.

Before beginning the installation, verify that the kit contents match the enclosed kit parts list.

**3.1 PRECAUTIONS**

1. Turn power to the cabinet off when installing any electrical or electronic device.
2. The SOUL EDGE PCB is a state of the art custom polygon graphics system that is very sensitive to electro static discharge (ESD). Be sure to use appropriate ESD reduction handling procedures such as use of ground straps. Handle the PCB using the anti-static material provided.



## **Kit Installation Manual**

---

3. The SOUL EDGE PCB can be damaged by even the small internal voltage of a multimeter or similar device. Never test the PCB for conductivity with such devices.
4. In the event of a PCB failure please contact your distributor for factory repairs.
5. Wrap return PCBs with a suitable anti-static foam or bubble wrap and label the return carton with the serial number and RMA number.
6. Dust or foreign matter may cause PCB failure. Dust can be removed using canned compressed air available at electronics supply stores. Turn the power off before cleaning the PCB.

### **3.2 CABINET PREPARATION**

Remove the following from the existing game or standard cabinet:

1. Game PCB
2. Control Panel
3. Marquee
4. Decals
5. Clean and fill all blemishes and dents and paint the exterior of the cabinet as needed.

### **3.3 GAME INSTALLATION**

1. Mount the game PCB to the side of the game cabinet and enclose in the FCC EMI Shield Box provided. Install the ferrite bead and clamp provided with the kit, locating it close to the shield box.
2. Connect the JAMMA and the 48 pin connector to the game PCB, and wire in accordance with the connector tables and system wiring diagram found in the back of the manual.
3. Connect the monitor.
4. Connect the coin door and the coin meter to the wire harness.
5. Connect the test/service panel.
6. Connect the speakers to the wire harness.

### **3.4 CONTROL PANEL**

1. Locate the joystick and push-button holes as available in a standard cabinet control panel, or use the layout drawing provided in this installation guide.

The hole sizes and positions are dimensioned in the provided template drawing. Be sure to check the clearance for the push buttons and joysticks under the control panel before punching the holes.

To fabricate a metal control panel, the easiest method is to drill a 1/4 inch pilot hole and then use an appropriate size metal hole style punch and wrench to punch the holes by hand.

2. Install the SOUL EDGE control panel overlay provided in the kit. Using the control panel cutouts as a guide trim the overlay to fit. Apply the G, A, B, K, Player 1 and Player 2 labels.
3. Install and connect the push button switches provided in the kit.
5. Install the control panel on the cabinet and connect the control panel wire harness to the game wire harness.
6. Use the enclosed SOUL EDGE dedicated game wiring diagram as a guide to verify system connections prior to turning on power.

### **3.5 CABINET GRAPHICS**

1. Install the cabinet side graphics provided. Float the graphics on by applying a spray of general purpose cleaner to the side wall. Smooth out the bubbles and liquid with a paint squeegee. Wipe the side decals dry with a soft cloth.
2. Install the marquee styrene provided in the kit in place of the existing marquee.
3. Install the game play and game moves instruction cards provided with the kit.
4. If needed, trim the graphics to fit the particular cabinet.

## Kit Installation Manual

### 4.0 SET-UP AND TEST

#### 4.1 TEST MODE

TEST mode allows the operator to test the game controls, set various game options, set coin options and test and adjust the video monitor.

**Important Note:**

**USA Recommended Factory Settings** are not the same as the Japanese factory defaults (in green). Namco's **USA Recommended Factory Settings** have been found to be the most suitable settings for most USA locations. However, these settings are operator adjustable and can be modified to best suit your location.

#### 4.2 TEST MODE PROCEDURE

To enter TEST Mode, open the coin door and set the TEST switch to the ON Position.

**Alt. Method:** Flip SW2 No. 1 on the System PCB to the ON position. SW2 No. 2 must remain OFF at all times.

To adjust the setup options, follow these steps in sequence:

- |    |                   |                     |
|----|-------------------|---------------------|
| A. | To Select         | Use Joystick        |
| B. | To Call Up Screen | Use Left "A" Button |
| C. | To Exit           | Use Left "B" Button |

#### 4.3 TEST MENU

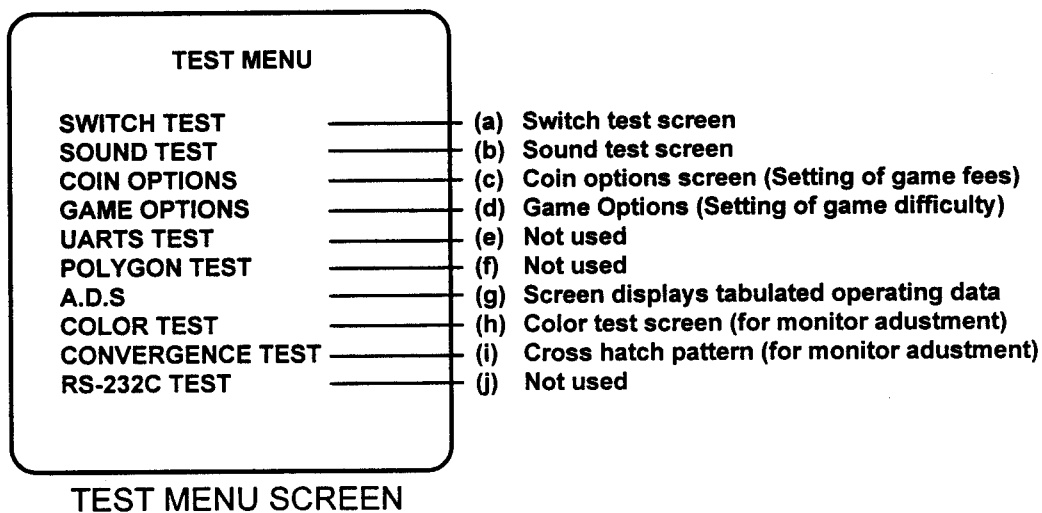

**4.3.1 Switch Test Screen**

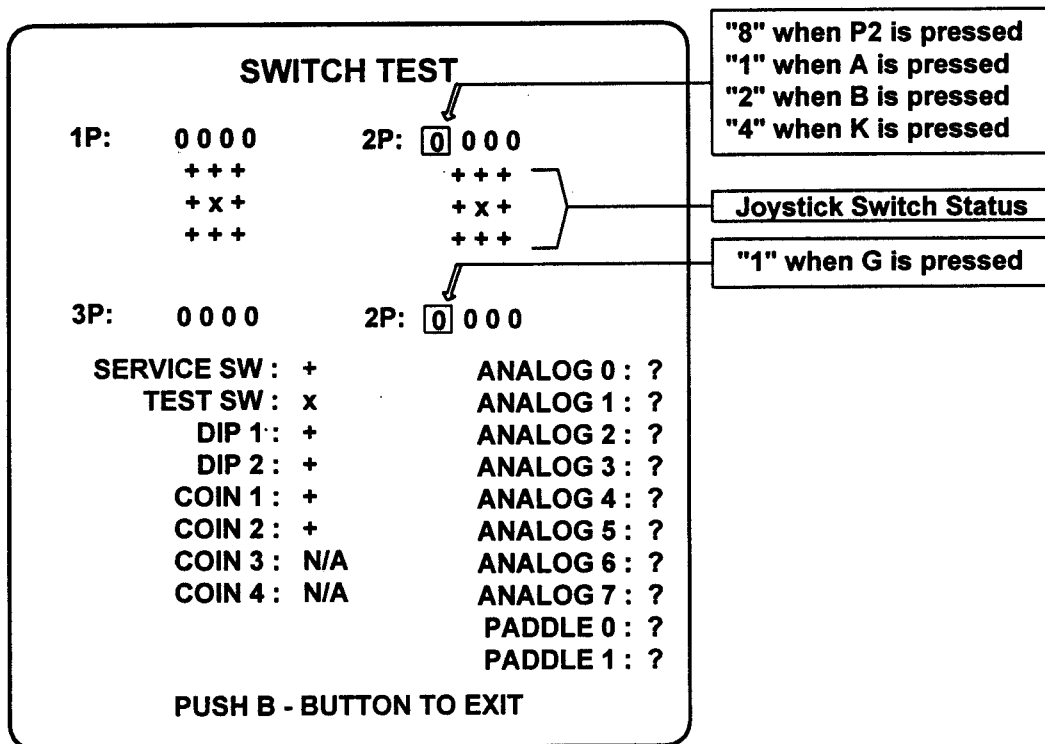

● 1B causes screen to exit to Main Menu

**4.3.2 Coin Options**

COIN OPTIONS [DEFAULTS IN GREEN]	ALL DEFAULTS SHOWN
GAME COST: 2 COINS 1 CREDIT	(A)
DISCOUNT TO CONTINUE: NO	(B)
COIN 1 MECH VALUE: 1 COIN COUNTS AS 1 COIN	(C)
COIN 2 MECH VALUE: 1 COIN COUNTS AS 1 COIN	(D)
COIN 3 MECH VALUE: 1 COIN COUNTS AS 1 COIN	
COIN 4 MECH VALUE: 1 COIN COUNTS AS 1 COIN	
BONUS FOR QUANTITY BUY-IN: NONE	(E)
CREDIT MODE: COMMON	(F)
COIN COUNTER: TYPE A: 1 COUNTER	(G)
FREE PLAY: NO	(H)

**COIN OPTION SCREEN**

- |     |                           |                                      |
|-----|---------------------------|--------------------------------------|
| (A) | Game Cost                 | 1-9 Coins = 1 Credit                 |
| (B) | Discount to Continue      | Yes/No                               |
| (C) | Coin 1 Mech Value         | 1 Coin = 1-9 Credits                 |
| (D) | Coin 2 Mech Value         | 1 Coin = 1-9 Credits                 |
| (E) | Bonus for Quantity Buy-In | None/1-9 Coins give 1-3 Coins        |
| (F) | Credit Mode               | Common/Each                          |
| (G) | Coin Counter              | Type A: 1 Counter/Type B: 2 Counters |
| (H) | Free Play                 | Yes/No                               |

**4.3.3 Game Options**

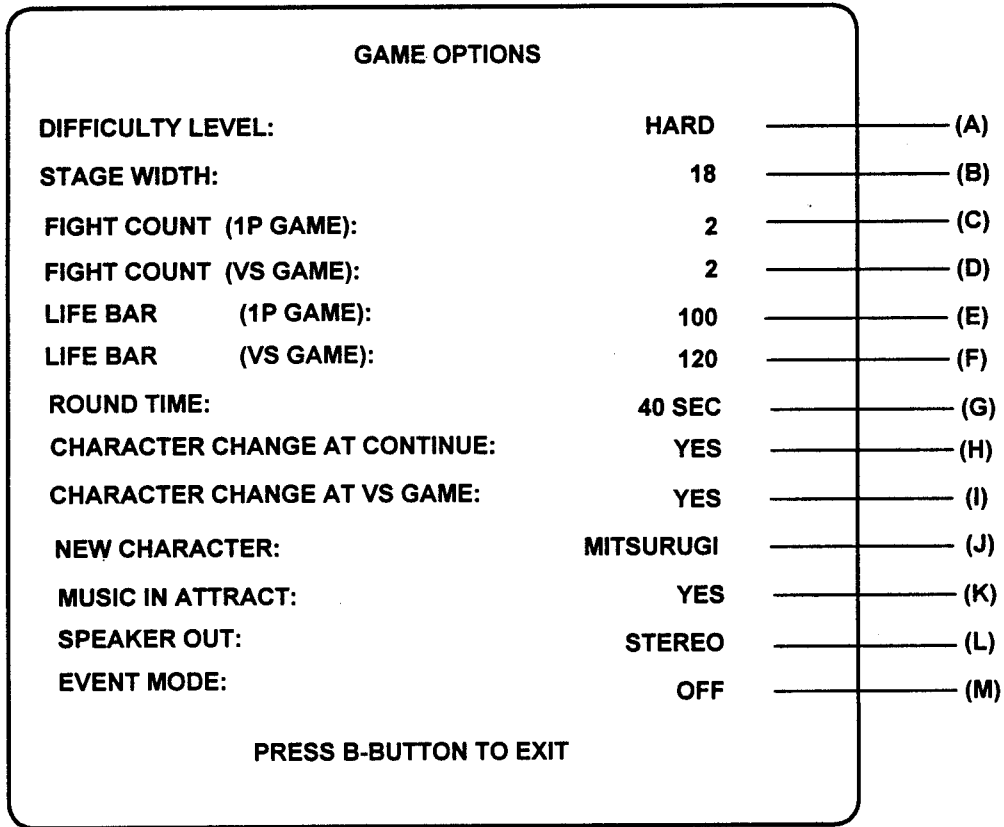

**GAME OPTION SCREEN**

- |     |                              |  |
|-----|------------------------------|--|
| (A) | Difficulty Level             | Easy, Medium, Hard, Extra Hard, Ultra Hard |
| (B) | Stage Width                  | 15, 17, 18, 20 m                           |
| (C) | Flight Count (1P Game)       | 1 thru 5                                   |
| (D) | Flight Count (VS Game)       | 1 thru 5                                   |
| (E) | Life Bar (1P Game)           | 90, 100, 110, 120, 130                     |
| (F) | Life Bar (VS Game)           | 90, 100, 110, 120, 130                     |
| (G) | Round Time                   | 30, 35, 40, 45, 50 sec                     |
| (H) | Character Change at Continue | Yes/No                                     |
| (I) | Character Change at VS Game  | Yes/No                                     |
| (J) | New Character                | Mitsurugi                                  |
| (K) | Music in Attract             | Yes/No                                     |
| (L) | Speaker Out                  | Stereo/Mono                                |
| (M) | Event Mode                   | Off/On                                     |

**4.3.4 A.D.S. Screens**

<b>A.D.S. MODE</b>			
ON TIME:		OH49M47S	
COIN 1 TOTAL 0			
COIN 2 TOTAL 0			
SERVICE TOTAL			
	<u>TOTAL TIME</u>	<u>COUNT</u>	<u>AVERAGE</u>
1P PLAY	OH00M00S	1	OH00M00S
1P PLAY	OH00M00S	0	OH00M00S
1P PLAY	OH00M00S	0	OH00M00S
ALL PLAY	OH00M00S	1	OH00M00S
ON TIME	OH00M00S		
PLAY RATIO	3.8%		
1P PLAY RATIO	100%	FREE PLAY	
VS PLAY RATIO	0%	0	
CLEAR:	PRESS P1	LEFT UP & P1 START	
NEXT:	PRESS P1	A-BUTTON	
EXIT:	PRESS P1	B-BUTTON	

A.D.S. Screen #1

<b>A.D.S. MODE</b>				
<b>CHARACTER DATA</b>				
	<u>RATE</u>	<u>TOTAL</u>	<u>1P</u>	<u>VS</u>
MITSURUGI	0%	0	0	0
SIEG	0%	0	0	0
VOLD	0%	0	0	0
SOPHITIA	0%	0	0	0
TAKI	0%	0	0	0
LEE	0%	0	0	0
NINA	0%	0	0	0
ROCK	0%	0	0	0
SOULEDGE	0%	0	0	0
HWANG	0%	0	0	0
CLEAR:	PRESS P1	LEFT UP & P1 START		
NEXT:	PRESS P1	A-BUTTON		
EXIT:	PRESS P1	B-BUTTON		

A.D.S. Screen #2

A.D.S. MODE CHARACTER DATA				
	<u>RATE</u>	<u>TOTAL</u>	<u>WIN</u>	<u>LOSE</u>
MITSURUGI	0%	0	0	0
SIEG	0%	0	0	0
VOLD	0%	0	0	0
SOPHITIA	0%	0	0	0
TAKI	0%	0	0	0
LEE	0%	0	0	0
NINA	0%	0	0	0
ROCK	0%	0	0	0
SOULEDGE	0%	0	0	0
HWANG	0%	0	0	0
CLEAR: PRESS P1 LEFT UP & P1 START				
NEXT: PRESS P1 A-BUTTON				
EXIT: PRESS P1 B-BUTTON				

A.D.S Screen #3



## 5.0 SOUND VOLUME ADJUSTMENTS

Two methods of volume adjustment are provided: a main adjustment on the System PCB, and, if wired in stereo, individual left/right control knobs located on the Service Panel. The volume may be set during bench testing by adjusting the PCB Volume potentiometer (located near the heat sink-mounted component). The Namco recommended setting is fully clockwise.

## 6.0 MONITOR ADJUSTMENTS

**IMPORTANT**

**Some monitors require use of an isolation transformer in the monitor power supply. Do not attempt to operate the SOUL EDGE PCB without this transformer or damage to the game PCB will result.**

## 7.0 PCB CONNECTOR TABLES

### 7.1 JAMMA EDGE CONNECTOR

(56 Pin 3.96 mm pitch)

Solder side	Terminal No.		Parts side
GND	A	1	GND
GND	B	2	GND
+5V	C	3	+5 V
+5 V	D	4	+5 V
	E	5	
+12 V	F	6	+12 V
Insertion error preventing	H	7	Insertion error preventing
Coin counter 2	J	8	Coin counter 1
	K	9	Coin lock out 1
Speaker (-)	L	10	Speaker(+)
Audio (GND)	M	11	Audio (+)
Video GREEN	N	12	Video RED
Video SYNC	P	13	Video BLUE
Service Switch	R	14	Video GND
	S	15	Test switch
Coin switch 2	T	16	Coin switch 1
2P start switch	U	17	1P start switch
2P lever UP	V	18	1P lever UP
2P lever DOWN	W	19	1P lever DOWN
2P lever LEFT	X	20	1P lever LEFT
2P lever RIGHT	Y	21	1P lever RIGHT
2P "A" button 1	Z	22	1P "A" button 1
2P "B" button 2	a	23	1P "B" button 2
2P "GUARD" button 3	b	24	1P "GUARD" button 3
	c	25	
	d	26	
GND	e	27	GND
GND	f	28	GND

+5V ± 5% 2.5A or more, +12V ±5% 2.0A or more

**Notes:**

- Do not connect leads to blank pins.
- The lockout solenoid and coin counter operate on +12 volts
- Connect the switches to N.O. terminals and the GND to the COM terminal
- The +5V 2.5 A and +12 V 2.0 A supplies must be at + or - 5%.

**7.2 EXTENDED EDGE CONNECTOR**  
(48 Pin 2.54 mm pitch)

Solder side	Terminal No.		Parts side
Speaker R (-)	A1	B1	Speaker R (+)
	A2	B2	
	A3	B3	
	A4	B4	
	A5	B5	Insertion error preventing key
	A6	B6	
	A7	B7	
2P Kick button	A8	B8	
	A9	B9	
	A10	B10	
	A11	B11	
	A12	B12	
	A13	B13	
	A14	B14	
	A15	B15	
	A16	B16	
	A17	B17	
	A18	B18	
	A19	B19	
1P Kick button	A20	B20	
	A21	B21	
	A22	B22	
	A23	B23	
	A24	B24	

**Notes:**

- Do not connect leads to blank pins.
- For Stereo and Mono setting select the speaker output in the game option screen in test mode.
- Monophonic cabinets output only left channel sound when the stereo sound setting is selected.

**Speaker connections**

- Connect the (L) speaker to the speaker output of 56 Pin JAMMA edge connector.
- Connect the Right speaker to the speaker output of the 48 Pin edge connector.

**APPENDIX A: ILLUSTRATIONS and PARTS LIST**

### SOUL EDGE KIT PARTS LIST

	Namco P/N	Description	Qty	U/M
1	SO03-04815-00	PCB ASSY, SYSTEM 11, SOUL EDGE, W/48 PIN CONNECTOR	1	ea
2	SO50-04940-00	HARNESS, JAMMA 56 PIN KIT	1	ea
3	SK47-00145-00	FCC FOIL SHIELD	1	ea
4	VG20-01370-00	PCB MOUNTING FOOT	4	ea
5	VG44-03213-00	LABEL, JAMMA, COMPONENT SIDE	1	ea
6	VG44-03213-01	LABEL, JAMMA, SOLDER SIDE	1	ea
7	VG46-02653-00	LABEL, FCC	1	ea
8	VG78-00198-00	FERRITE CLAMP	2	ea
9	VG78-00199-00	FERRITE HOUSING	1	ea
10	SO40-04633-01	DECAL, MARQUEE, STYRENE, KIT, 31 INCH	1	ea
11	SO40-04634-00	DECAL, SIDE PANEL, LEFT, WOMAN	1	ea
12	SO40-04634-01	DECAL, SIDE PANEL, RIGHT, MAN	1	ea
13	SO40-04635-01	DECAL, CONTROL PANEL, (UNCUT)	1	ea
14	SO40-04636-00	CARD, GAME INSTRUCTIONS (UNSCORED)	1	ea
15	SO40-04637-00	CARD, MOVE LIST (UNSCORED)	1	ea
16	SO40-04642-00	DECAL, HORIZONTAL ATTACK	2	ea
17	SO40-04643-00	DECAL, VERTICAL ATTACK	2	ea
18	SO40-04644-00	DECAL, GUARD	2	ea
19	SO40-04645-00	DECAL, KICK	2	ea
20	SO40-04646-00	DECAL, PLAYER 1	1	ea
21	SO40-04647-00	DECAL, PLAYER 2	1	ea
22	SO40-04711-00	DECAL, GAME NAME, "SOUL EDGE"	2	ea
23	TK95-03332-00	COVER, CONTROL PANEL, POLYCARBONATE, CLEAR	1	ea
24	VG80-04707-00	ASSY, BUTTONS AND JOYSTICKS, SOUL EDGE	1	ea
	VG80-00006-00	PUSH-BUTTON, W/HORZ., M-SW, WHT, LEGEND "1P"	1	ea
	VG80-00007-00	PUSH-BUTTON, W/HORZ., M-SW, WHT, LEGEND "2P"	1	ea
	VG80-03167-00	PUSH-BUTTON, W/HORZ., M-SW, YELLOW	8	ea
	VG80-03212-00	JOYSTICK, 4-WAY/8-WAY BLACK "SUPER"	2	ea
25	SO45-04853-00	MANUAL, KIT INSTALLATION, SOUL EDGE	1	ea

# SOUL EDGE Control Panel Assembly

SO10-04679-00

NO	PART NO	DESCRIPTION	QTY
1	S063-04678-00	Control Panel, Wood	1
2	SO10-04679-00	Control Panel, Metal w/studs	1
3	S040-04635-00	Decal, Control Panel Overlay	1
4	S095-04680-00	Cover, Control Panel, Plexiglass	1
5	VG20-04342-12	Screw, Btn.-Hd., Torx, Sht. Mtl., Tamperproof, Bk, Oxide	8
6	VG20-02864-05	Washer, Flat, #10, Steel, Zinc	8
7	VG20-02700-05	Nut, Kep, #10-24, Steel, Zinc	8
8	VG80-00006-00	Push Button, w/Horz. M-Switch, White, Legend: "1P"	1
9	SO40-04646-00	Decal, Player 1	1

NO	PART NO	DESCRIPTION	QTY
10	VG80-00007-00	Push Button, w/Horz. M-Switch, White, Legend: "2P"	1
11	SO40-04647-00	Decal, Player 2	1
12	VG80-03167-00	Push Button, w/Horz. M-Switch, Yellow	8
13	SO40-04645-00	Decal, Kick "K"	2
14	SO40-04643-00	Decal, "B"	2
15	SO40-04642-00	Decal, "A"	2
16	SO40-04644-00	Decal, Guard "G"	2
17	VG80-03212-00	Joystick, 4-Way/8-Way Black "Super"	2
18	VG20-02700-05	Nut, Kep, #10-24, Steel, Zinc	8

# SOUL EDGE Control Panel (Top View)

SO10-04679-00

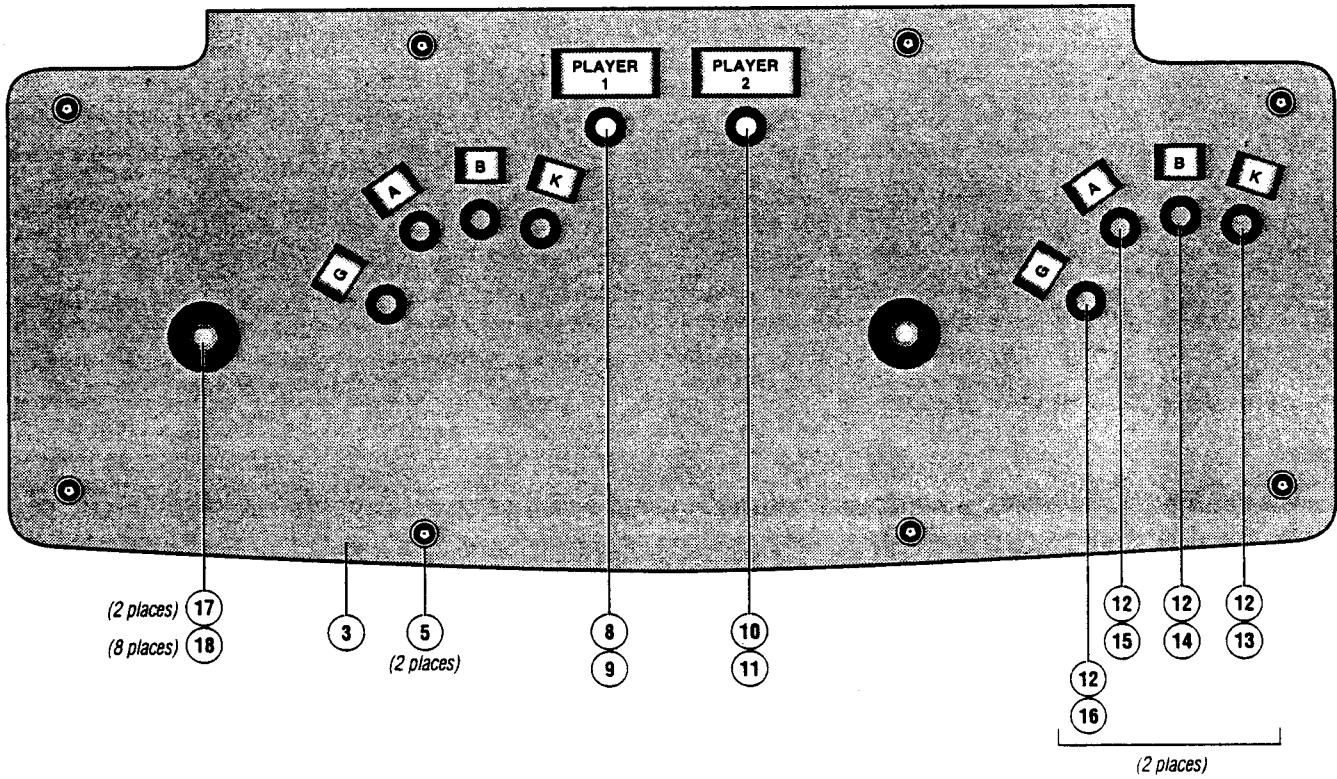

# SOUL EDGE Control Panel (Side View)

SO10-04679-00

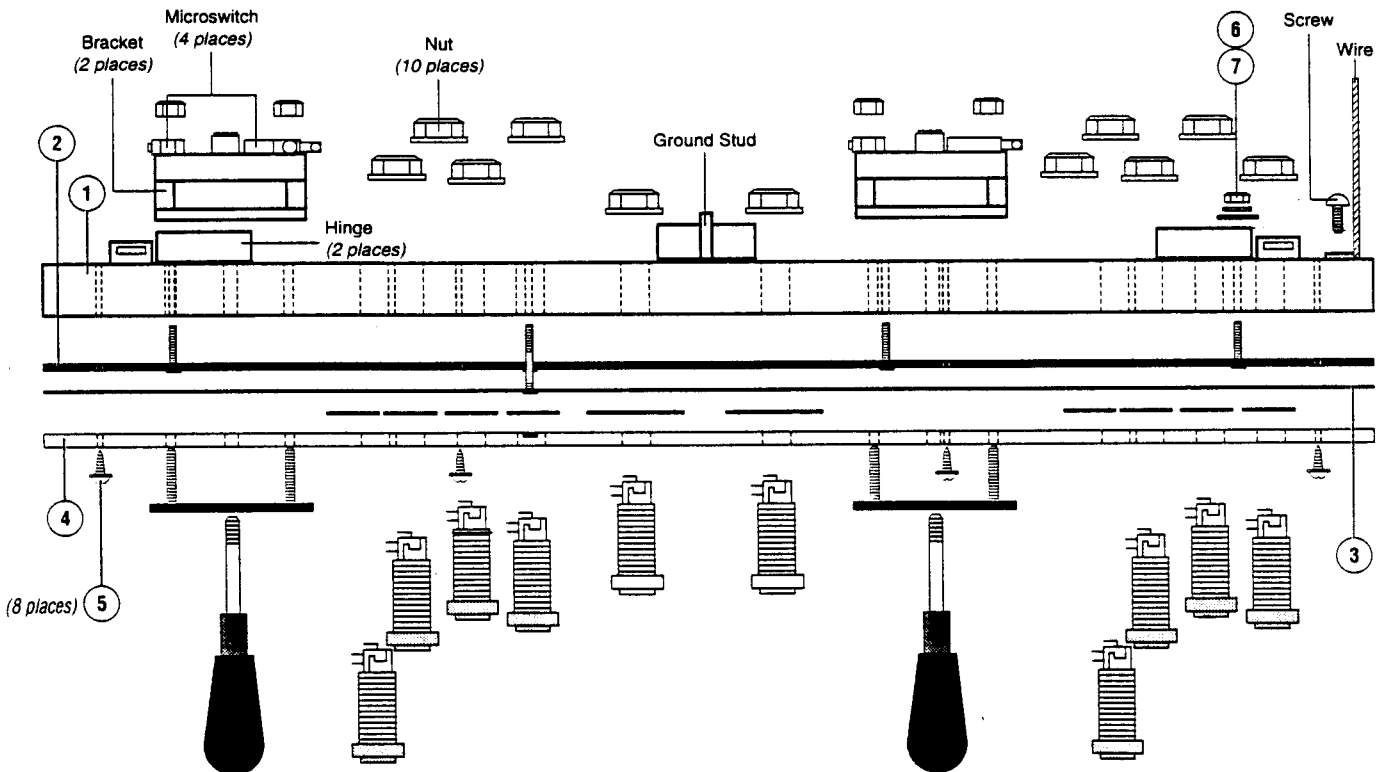

REVISION

LTR	ECO	DATE	DESCRIPTION	BY	APPR
1		2-12-96	INITIAL RELEASE	J.P.	

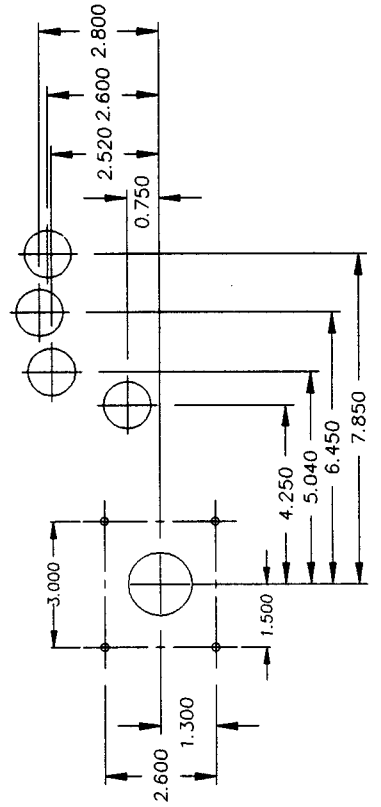
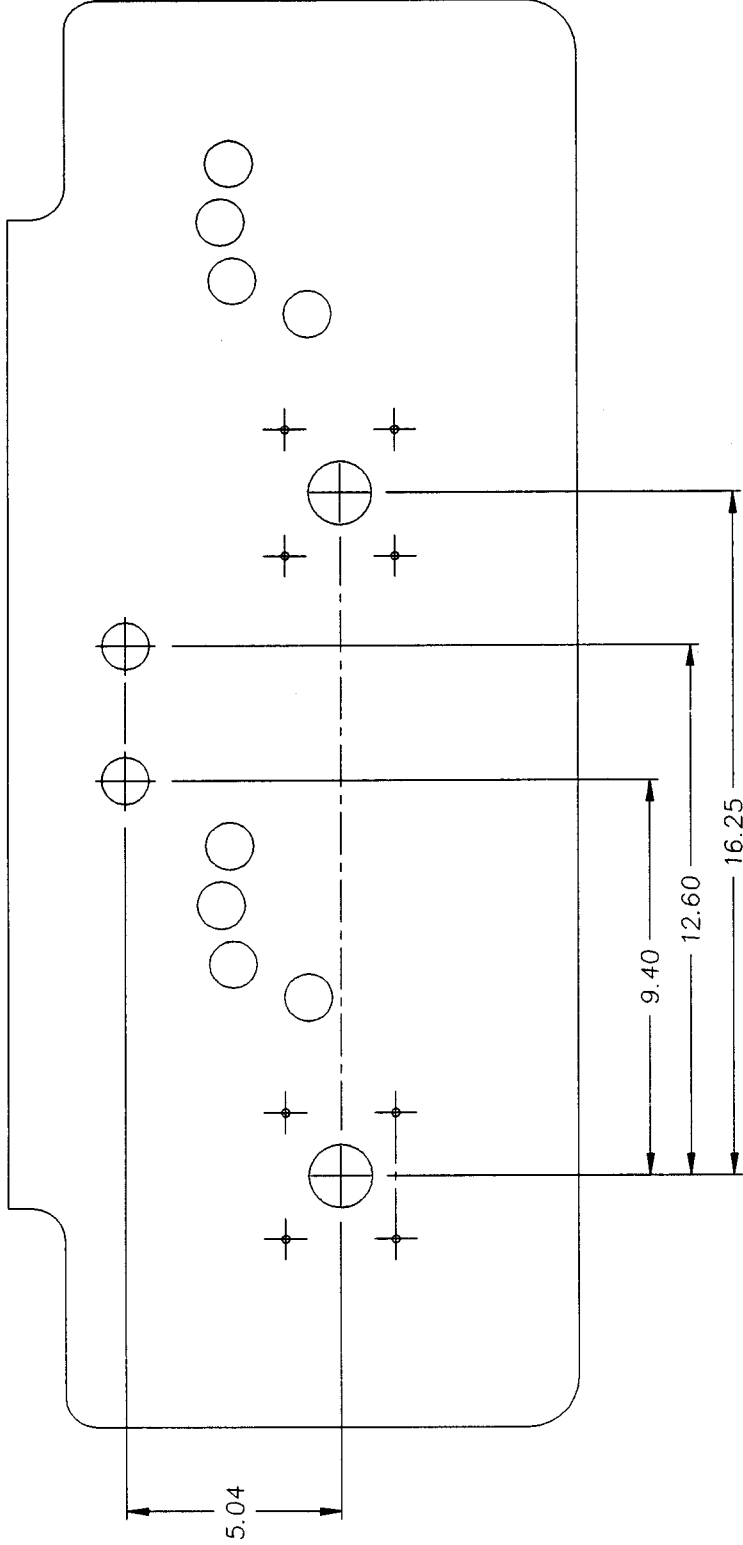

DETAIL, 2 PLACES

NOTES UNLESS SPECIFIED TOLERANCES	DRAWN	J. PINEDA	12-7-95
.XX +/- .03	DESIGN		
.XXX +/- .015	MATERIAL		
ANGULAR +/- 1°	FINISH		
DIMENSIONS APPLY AFTER FINISH	CHECKED AND APPROVED		
DO NOT SCALE	USED ON		
	SOUL EDGE		
TITLE		SOUL EDGE CONTROL PANEL HOLE LOCATION	
SIZE		B	
DWG NO.			
REV.		1	
SCALE	FULL	FILE NAME	HOLE2
		SHEET	1 OF 1

**nanco** 150 Charcot Avenue  
San Jose, California 95131



**APPENDIX B: WIRING DIAGRAM**

REV	DESCRIPTION	DATE	APPROVAL
A			

NOTES:  
 1. APPLY BRAGS FOR THICK LINES AND 22AWG FOR THIN LINES  
 2. (C) INDICATES RING TERMINAL  
 3. LABELS ARE APPLIED TO BOTH SIDES OF 56 PIN CONNECTOR  
 4. KEYS ARE APPLIED ON BOTH 56 AND 48 PIN CONNECTORS.

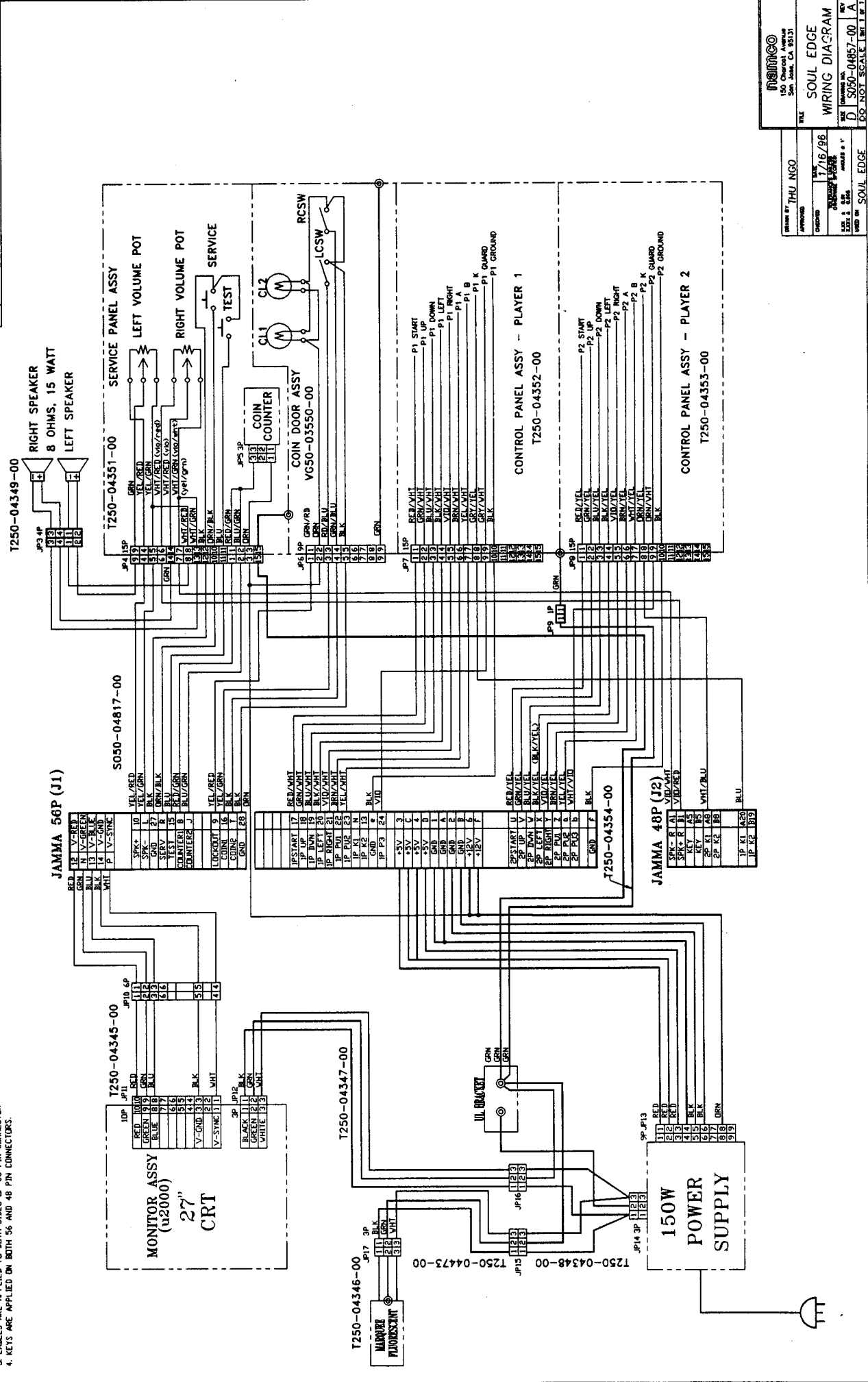

## WARRANTY

Seller warrants that its printed circuit boards and parts thereon are free from defects in materials and workmanship under normal use and service for a period of ninety (90) days from the date of shipment. Seller warrants that its video displays (in games supplied with video displays) are free from defects in material and workmanship under normal use and service for a period of thirty (30) days from the date of shipment. None of the Seller's other products or parts thereof are warranted. Seller's sole liability shall be, at its option, to repair, replace, or credit Buyer's account for such products which are returned to Seller during said warranty period, provided:

- a) Seller is promptly notified in writing upon discovery by Buyer that said products are defective.
- b) Such products are returned prepaid to Seller's plant, and
- c) Seller's examination of said products discloses to Seller's satisfaction that such alleged defects existed and were not caused by accident, misuse, neglect, alteration, improper repair, improper installation, or improper testing.

In no event shall Seller be liable for loss of profits, loss of use, incidental or consequential damages.

Except for any express warranty set forth in a written contract between Seller and Buyer which contract supersedes the terms herein, this warranty is in lieu of all other warranties expressed or implied, including the implied warranties of merchantability and fitness for a particular purpose, and all other obligations or liabilities on the Seller's part, and it neither assumes nor authorizes any other person to assume for the Seller any other liabilities in connection with the sale of products by Seller.

**Namco America Inc.** distributors are independent, being privately owned and operated. In their judgment they may sell parts or accessories other than **Namco America Inc.** parts or accessories. **Namco America Inc.** cannot be responsible for the quality, suitability or safety of any non-**Namco America Inc.** part or any modification including labor which is performed by such distributor.

## SERVICE

If you have questions regarding any **Namco America Inc.** product or require technical support:

Contact **Namco America Inc.** Customer Service at:

1 (800) 326-4263 or FAX (408) 232-3060

Hours: 8:00 am - 4:00 pm PDT

Parts and repair services for **Namco America Inc.** products are available through your distributor.

**NAMCO AMERICA INC.**

150 Charcot Ave.  
San Jose, CA 95131  
(408) 383-3900

**FAX: (408) 383-0128**

**Technical Assistance (USA)**

**(800) 326-4263**

**Fax: (408) 232-3060**

Reorder Number SO45-04853-00

REV. B