

SPACE COLOR CHASER

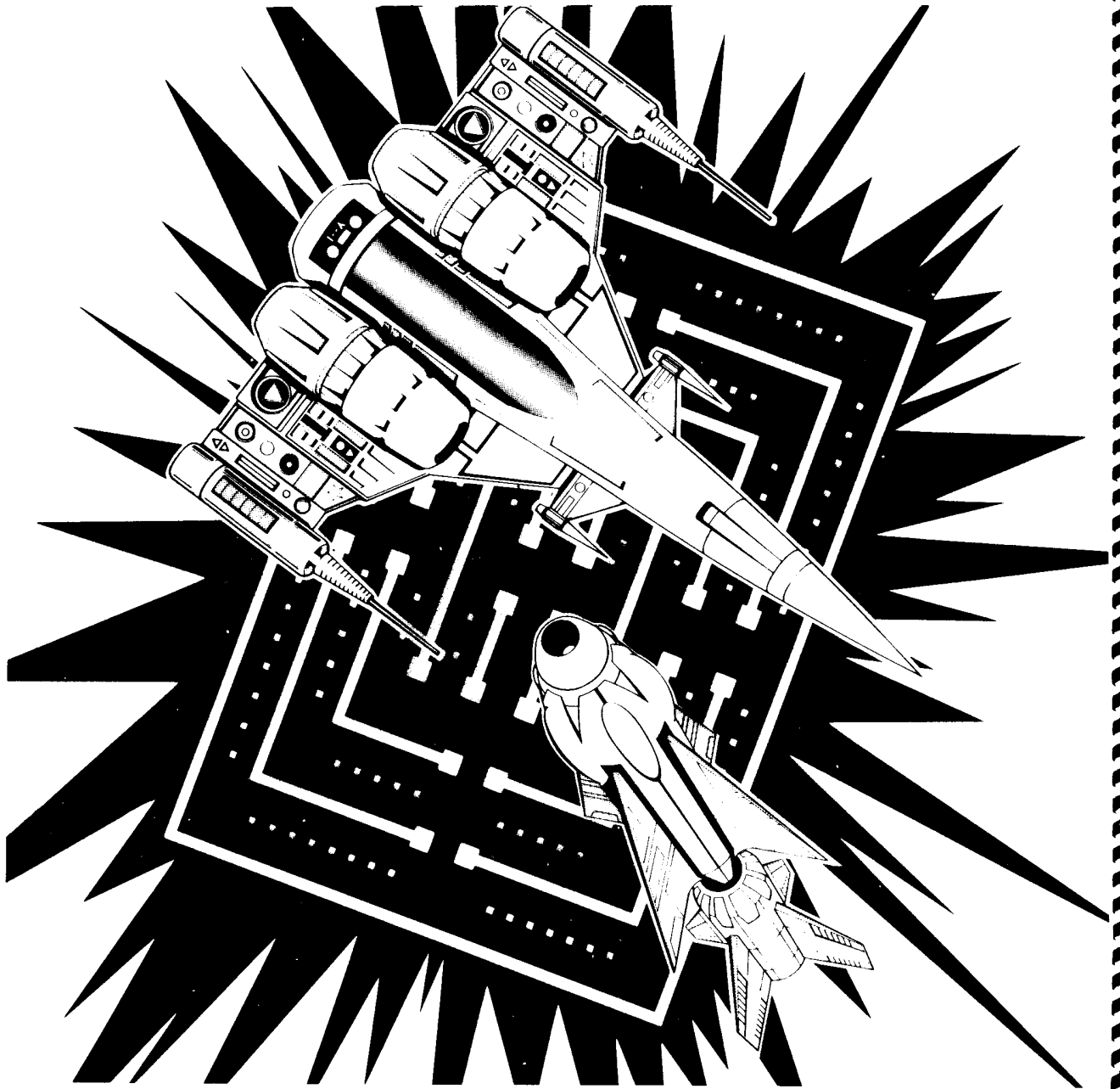



AND PARTS CATALOG



TAITO CORPORATION

5. Playing Instruction

- o One or two players can play.
- o Insert coin(s), and select one or two player game.
 - 1 coin - 1 play ... 3 Spaceships (Adjustable)
 - 2 coins - 2 plays(1 - player game)
 - 1 play (2 - player game)
- o Spaceship (yellow)  and chaser Missile  will appear on the screen.
- o Control the Spaceship by using the Control Lever and clear dots (■) without colliding into oncoming chaser missiles.
- o By pushing the Thrust Button, the Spaceship can be some distance ahead of the Chaser Missile, but the fuel and bonus points decrease.
- o In two player mode, the play alternates between the two.

Functional Description of Game:

- o Points for a dot increase by 10 points per frame (up to 90 points) every time all dots in a frame have been created. (Bonus points will be added.)
- o The bonus points are 4,000 points at the game atart, and will decrease by pushing the Thrust Button.
- o Green Zone will appear on the course for accelerating the Chaser Missiles.
- o The second Chaser Missile will appear when the score reaches 10,000 points,
- o Game ends when the lest Spaceship is distroyed by the Chaser Missile.
- o The high-scorer's name can be registered on the screen. Any waony wording can be cancelled by pushing the Name Reset Button, but the high score will not be cancelled.

Method:

- (1) The alphabets ("A"- "Z"), "RUB", and "END" will be displayed on the screen. By moving the control lever, move the red underline to the alphabet one by one so that the high-scorer's name can be spelled.
- (2) An alphabet on the red underline can be registered at a time on the screen by pushing the thrust button.

"RUB" ... If any wrong alphabet has been registered, move the red underline to the word "RUB", and push the thrust button so that the alphabet will be canceled.

"END" ... When finishing the high-scorer's name registration move the red underline to the word "END" and push the thrust button.

- (3) The high-scorer's name register can mode within one and half minutes. After one and half minutes passed, the registration will be automatically stopped.
(In total, ten alphabets can be registered.)

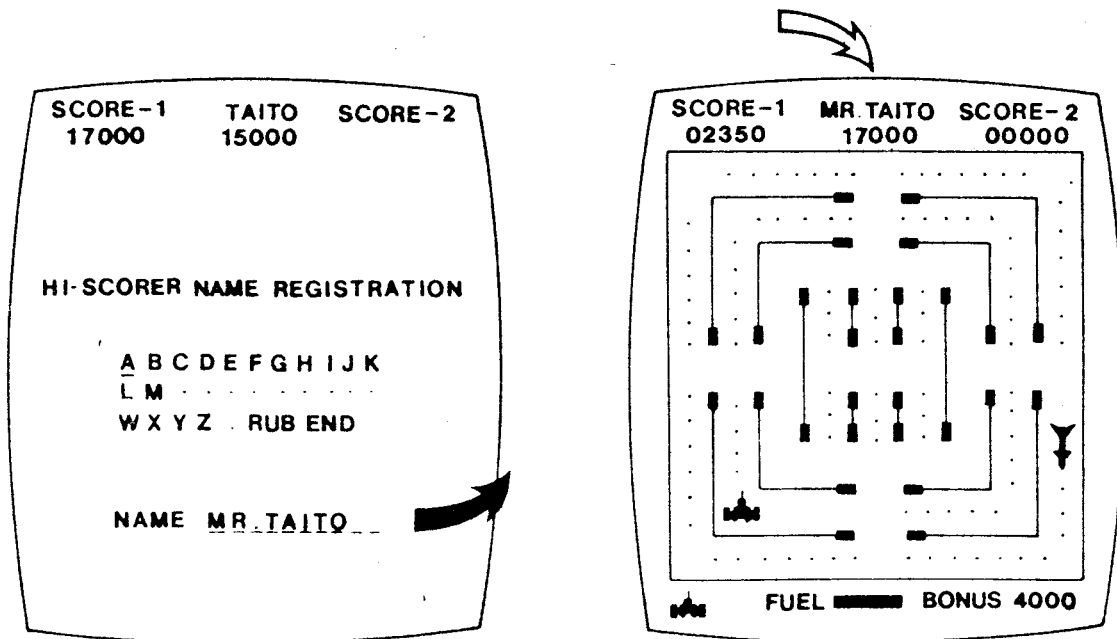

Fig.3

6. Adjustments on Switching Regulator PC Board

(See Fig. 4)

Caution: The line voltages should be set within the limit.
Failure to do so may result in destruction of the IC's.

o To check the output voltage, measure them on the G-connector or the T-connector.

(See the attaching cable Block Diagram NO. AAR00196.)

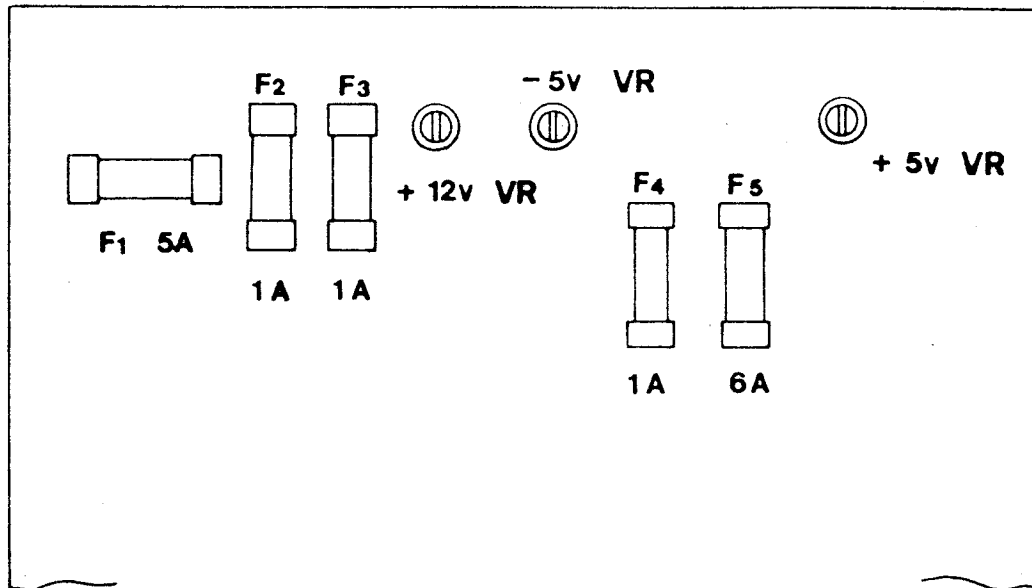

Fig. 4

- o +5V VR ... Pot for adjusting +5V DC line voltage
(Adjustment range: +4.5V to +5.5V DC)
Set approx. +5V.
- o -5V VR ... Pot for adjusting -5V DC line voltage
(adjustable range: -5.5V to -4.5V DC)
Set approx. -5V.

(When the +5V line has no load, this -5V
voltage is not present on the line.)
- o +12V VR ... Pot for adjusting +5V DC line voltage
(Adjustable range: +10.8V to +13.2V DC)
Set approx. +12V.

7. Adjustments on Game PC Board (See Fig. 5 and Table 1)

- o To decrease the sound, turn each pot (VR1 -VR4) to the direction shown below with arrowheads.

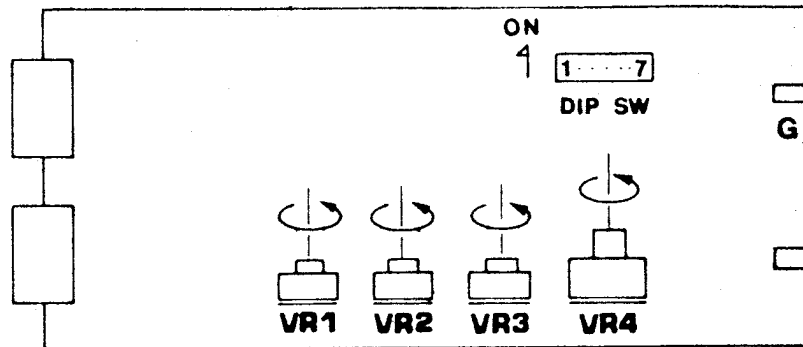

Fig,5

- VR1 ... Pot for adjusting the music sound
- VR2 ... Pot for adjusting the effect sound and the explosion sound
- VR3 ... Pot for adjusting the dot - hitting sound
- VR4 ... Pot for adjusting the total sound

Change-over of DIP Switches;

- o SW1,SW2 ..Switches for changing the number of spaceships

SW 1	ON	OFF	ON	OFF
SW 2	ON	ON	OFF	OFF
Number of Spaceships	3	4	5	6

Table.1

These switches have been preset at "ON" position at the factory. (3 spaceships at the game start)

- o SW3-SW6 ..Switches for adjusting solid-state modules
These switches are for factory adjustments, and all of them should be set at "ON" position.
- o SW7 Switch for rotating images on the screen
When the switch is set at "OFF" position, the images on the screen will be rotated
This switch should be set at "ON" position.

8. Adjustments on Color Video Monitor (See Fig. 6)

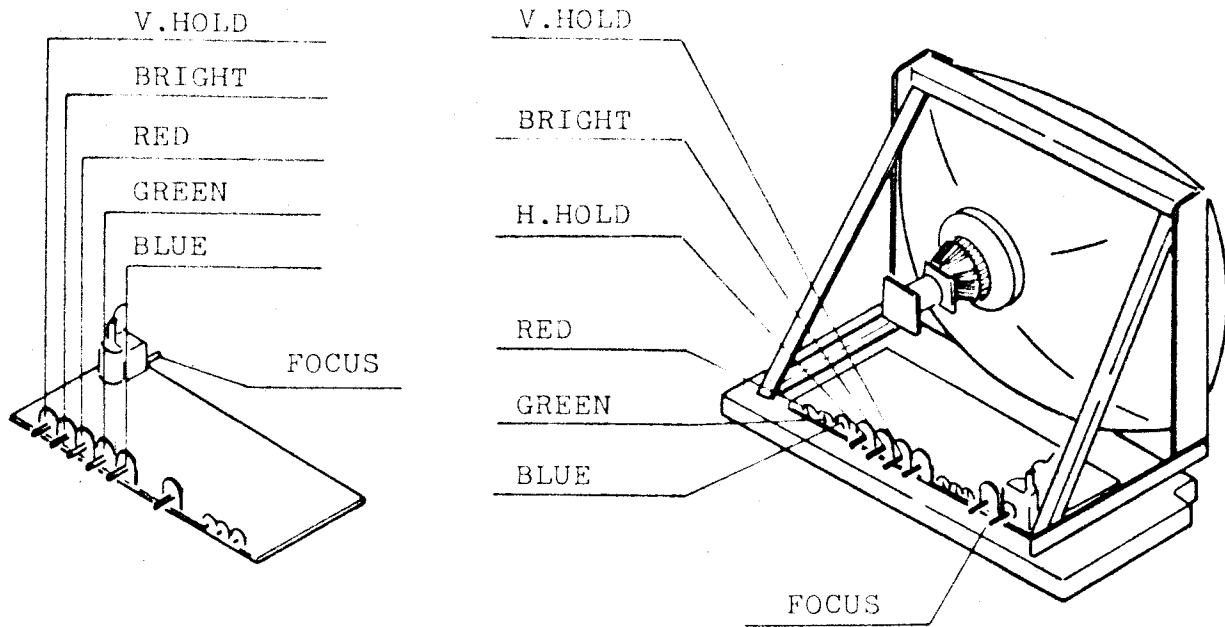

Fig. 6

The video monitor is properly adjusted before shipping, however, if necessary, readjust as follows:

Caution: Careful adjustments are required for the H.Hold and the V.Hold adjustments.

o Horizontal Hold

Adjust the H.HOLD control if the picture is warped or broken into diagonal lines.

o Vertical Hold

Adjust the V.HOLD control if the picture rolls vertically across the screen.

o Screen Brightness

Adjust the BRIGHT control to keep the screen clear.

o FOCUS ... Screen Focus Control

o RED, GREEN, and BLUE ... Color Controls

Note: (1) Color aberration may occur depending on the setting condition of the machine. In that case, use a degussing device. Keep magnet away from the screen, otherwise, it may result in color aberration.

(2) The color video monitor of Taito "SPACE CHASER" is for exclusive use, therefore, it can not be replaced with that of other models.

9. Adjustments of Supply Voltage (See Fig. 7)

If the voltage of the power supply is low, the picture on the screen sometimes gluckers. In that case, change the connection of the power transformer terminals in the cabinet. This adjustment is obtained by using the change-over switch.

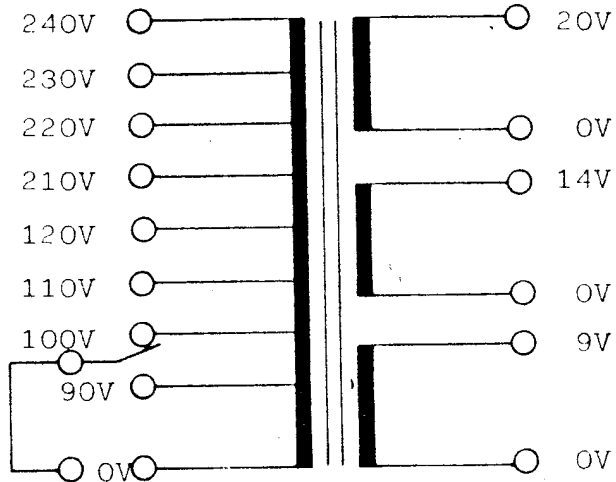

Fig. 7

10. Typical Picture During Play (See Fig.8)

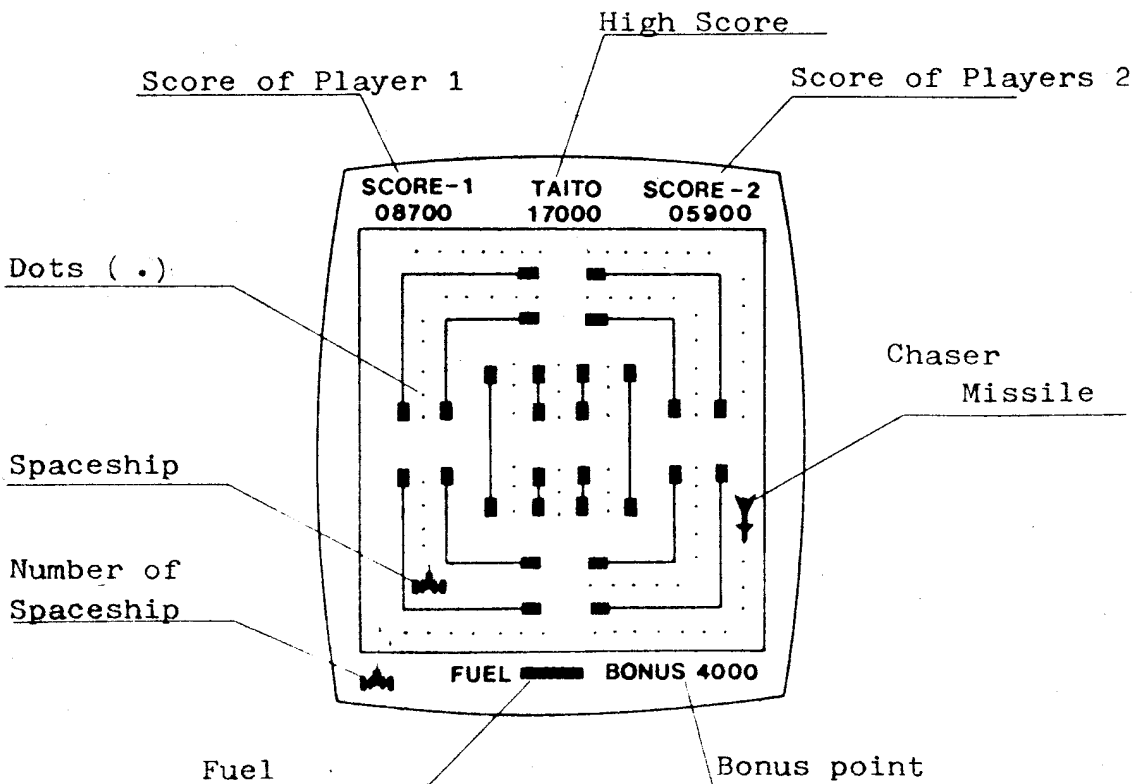
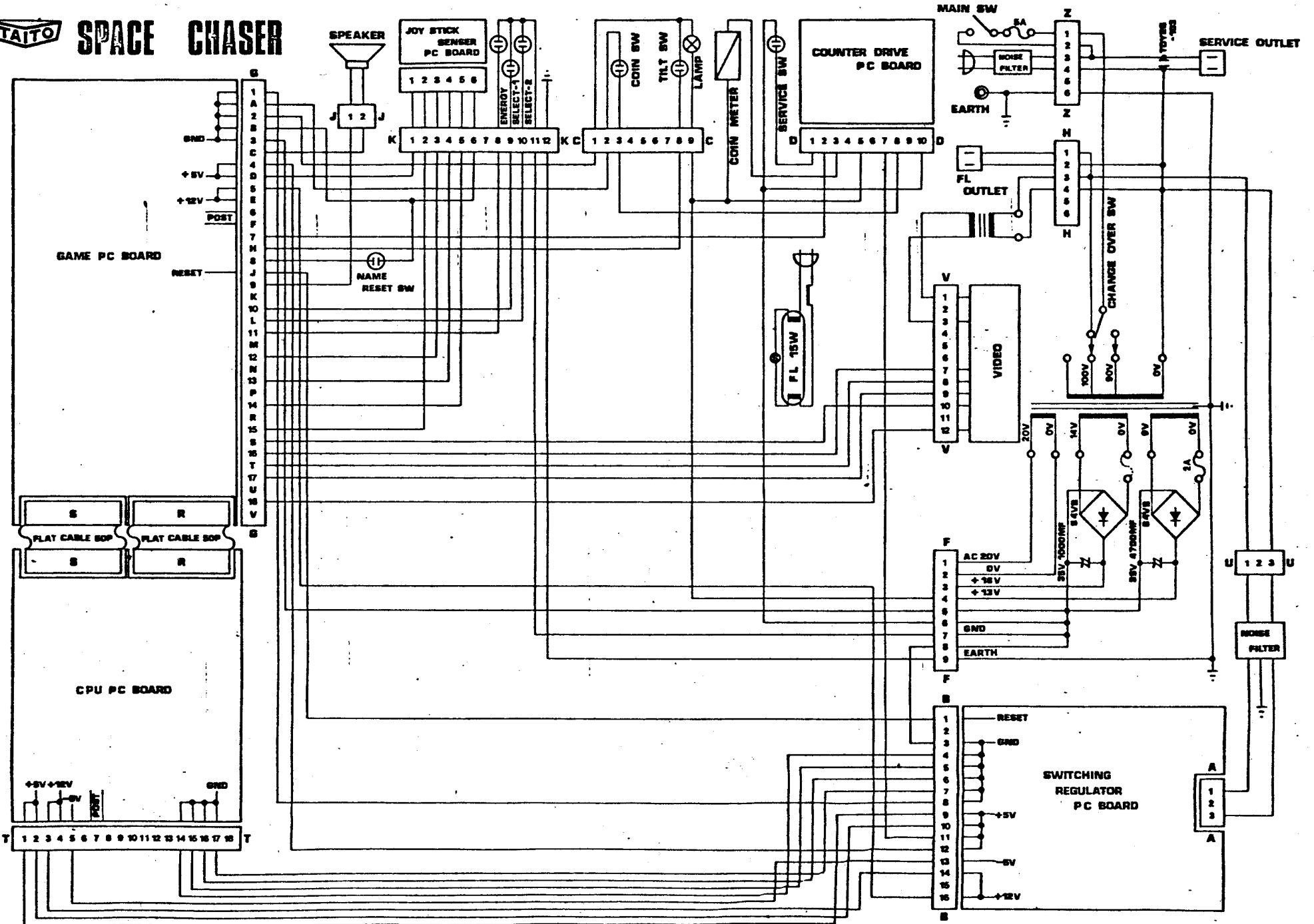
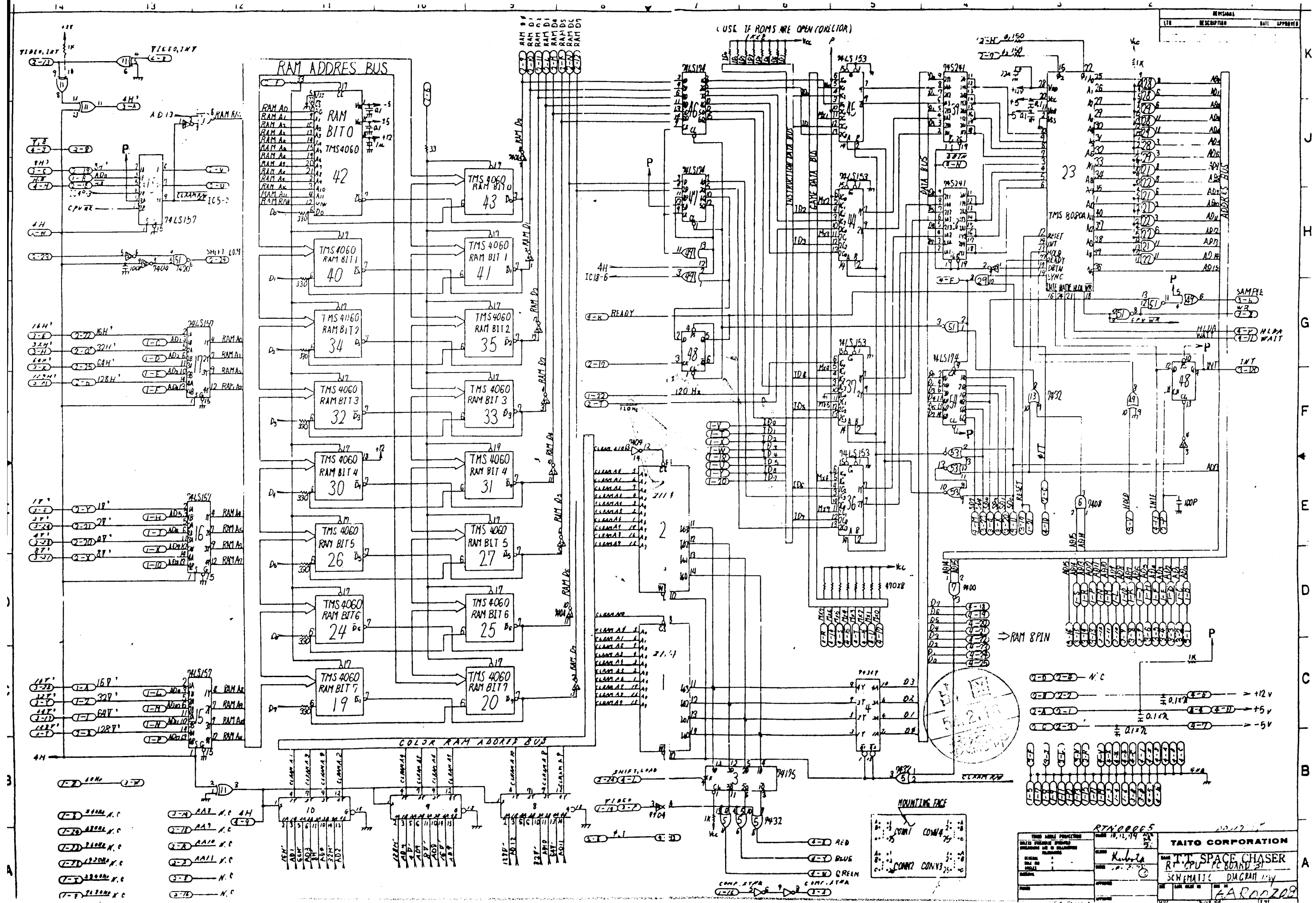

Fig. 8



SPACE CHASER





14

13

12

11

10

9

8

7

6

5

4

3

2

1

K
J
I
H
G
F
E
D
C
B
A

REV	DESCRIPTION	DATE	APPROVED
1			

COMP. TYPE	COMP. VALUE	COMP. TYPE	COMP. VALUE
1-1	100K	1-2	100K
1-3	100K	1-4	100K
1-5	100K	1-6	100K
1-7	100K	1-8	100K
1-9	100K	1-10	100K
1-11	100K	1-12	100K
1-13	100K	1-14	100K
1-15	100K	1-16	100K
1-17	100K	1-18	100K
1-19	100K	1-20	100K
1-21	100K	1-22	100K
1-23	100K	1-24	100K
1-25	100K	1-26	100K
1-27	100K	1-28	100K
1-29	100K	1-30	100K
1-31	100K	1-32	100K
1-33	100K	1-34	100K
1-35	100K	1-36	100K
1-37	100K	1-38	100K
1-39	100K	1-40	100K
1-41	100K	1-42	100K
1-43	100K	1-44	100K
1-45	100K	1-46	100K
1-47	100K	1-48	100K
1-49	100K	1-50	100K
1-51	100K	1-52	100K
1-53	100K	1-54	100K
1-55	100K	1-56	100K
1-57	100K	1-58	100K
1-59	100K	1-60	100K
1-61	100K	1-62	100K
1-63	100K	1-64	100K
1-65	100K	1-66	100K
1-67	100K	1-68	100K
1-69	100K	1-70	100K
1-71	100K	1-72	100K
1-73	100K	1-74	100K
1-75	100K	1-76	100K
1-77	100K	1-78	100K
1-79	100K	1-80	100K
1-81	100K	1-82	100K
1-83	100K	1-84	100K
1-85	100K	1-86	100K
1-87	100K	1-88	100K
1-89	100K	1-90	100K
1-91	100K	1-92	100K
1-93	100K	1-94	100K
1-95	100K	1-96	100K
1-97	100K	1-98	100K
1-99	100K	1-100	100K

TAITO CORPORATION
 RT-CPU PC BOARD #1
 SCHEMATIC DIAGRAM
 KURODA
 DATE: 11.14.75
 DRAWN BY: KURODA
 CHECKED BY: KURODA
 APPROVED BY: KURODA

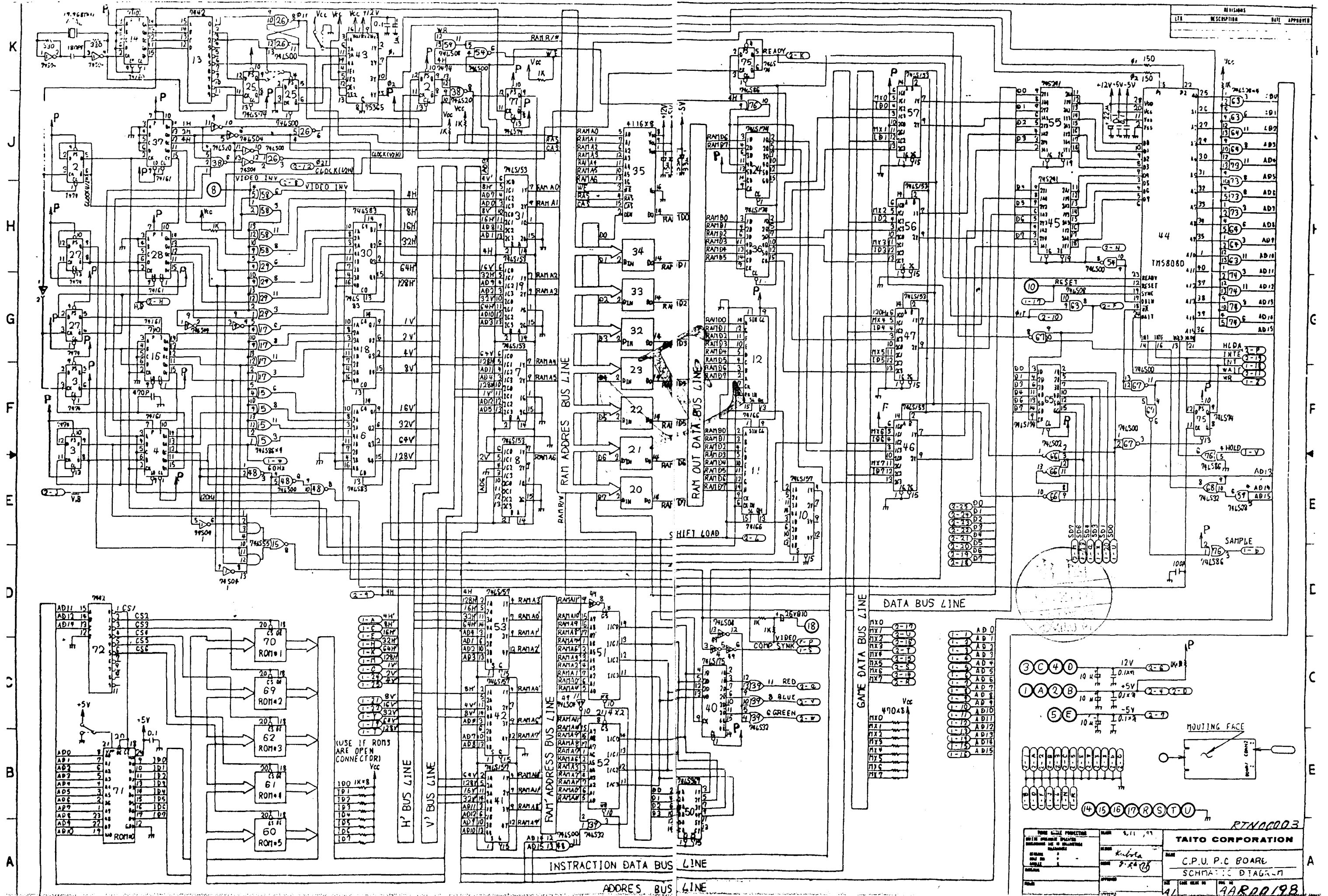

REV	DESCRIPTION	DATE	APPROVED

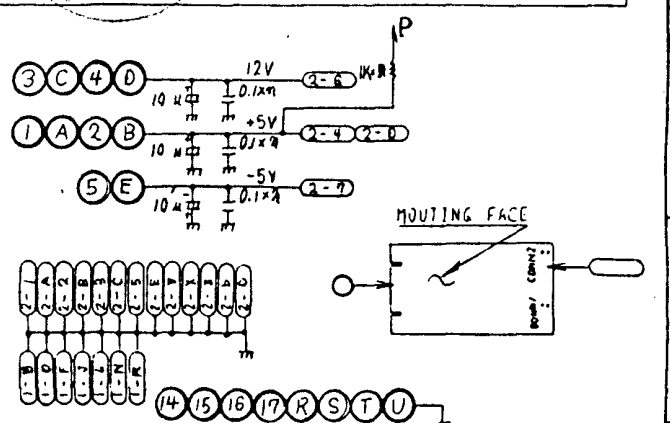

TAITO CORPORATION	
C.P.U. P.C. BOARD	
SCHEMATIC DIAGRAM	
DATE: 8.11.77	REV: 1
DESIGNER: KUBOTA	DATE: 8.24.77
DR: 41	REV: 1

REVISIONS			
LTN	DESCRIPTION	DATE	APPROVED

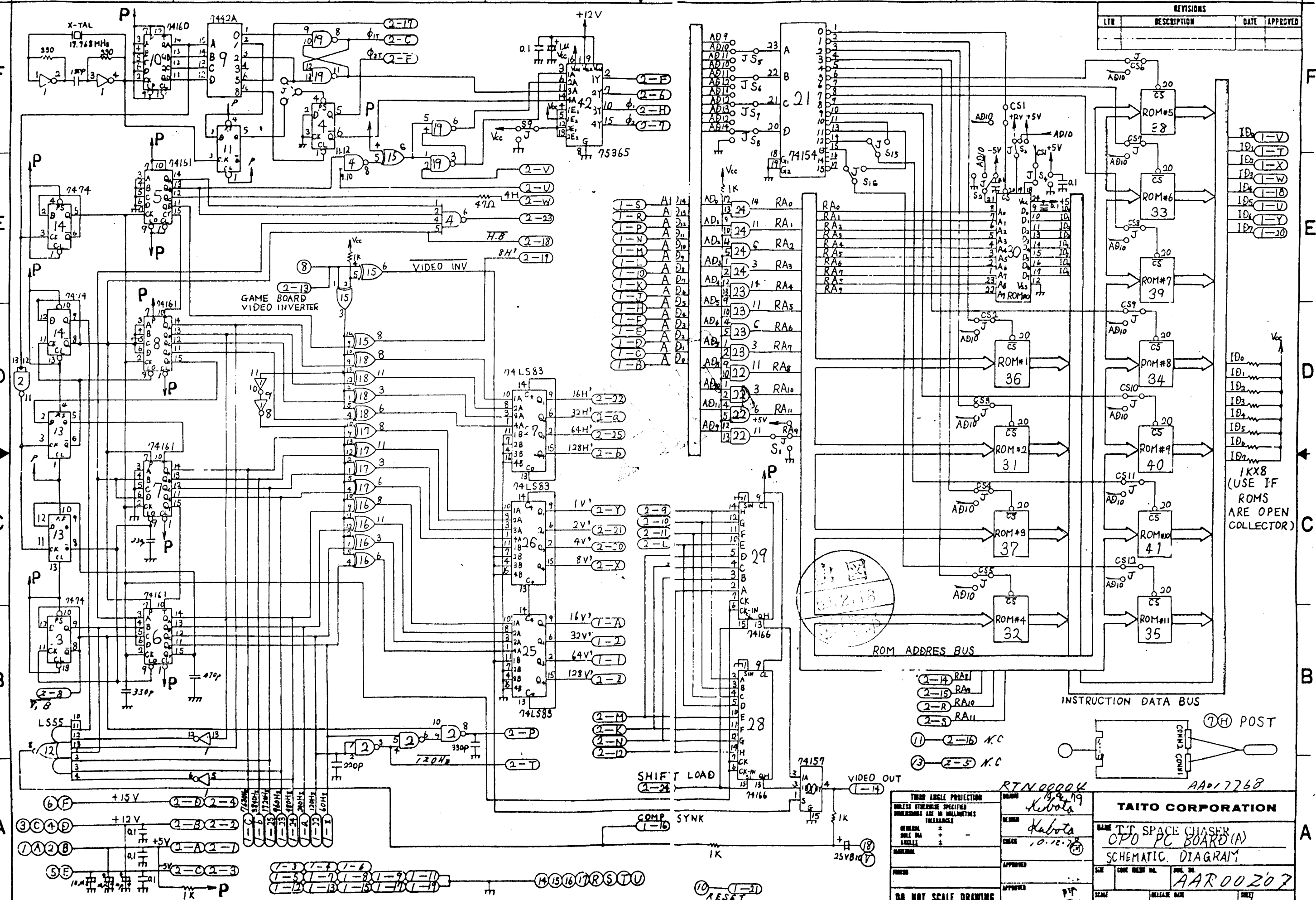

- (1-S) A1 1/4
- (1-R) A 2/10
- (1-P) A 2/11
- (1-N) A 2/11
- (1-M) A 2/11
- (1-L) A 2/11
- (1-K) A 2/11
- (1-J) A 2/11
- (1-H) A 2/11
- (1-E) A 2/11
- (1-D) A 2/11
- (1-C) A 2/11
- (1-B) A 2/11

- (2-9)
- (2-10)
- (2-11)
- (2-L)

- (1V) (2-Y)
- (2V) (2-21)
- (4V) (2-20)
- (8V) (2-X)

- (2-14) RA1
- (2-15) RA2
- (2-R) RA10
- (2-S) RA11

- (11) (2-16) K.C
- (13) (2-5) K.C

- (1-3) (1-4) (1-5)
- (1-6) (1-7) (1-8) (1-9) (1-10)
- (1-11) (1-12) (1-13) (1-14) (1-15)

THIRD ANGLE PROJECTION
 UNLESS OTHERWISE SPECIFIED
 DIMENSIONS ARE IN MILLIMETERS
 TOLERANCES

GENERAL ±
 HOLE DIA ±
 ANGLES ±

DATE: 10.12.78
 CHECK: [Signature]
 APPROVED: [Signature]
 P.S.P.

DO NOT SCALE DRAWING

RTN0000K
 AA017768

TAITO CORPORATION

NAME: TAITO SPACE CHASER
 CPO PC BOARD (A)
 SCHEMATIC DIAGRAM

SIZE: [] CORE SHEET NO.: [] FILE NO.: AAR00207
 SCALE: [] SHEET NO.: []

REVISIONS			
LTN	DESCRIPTION	DATE	APPROVED

F
E
D
C
B
A

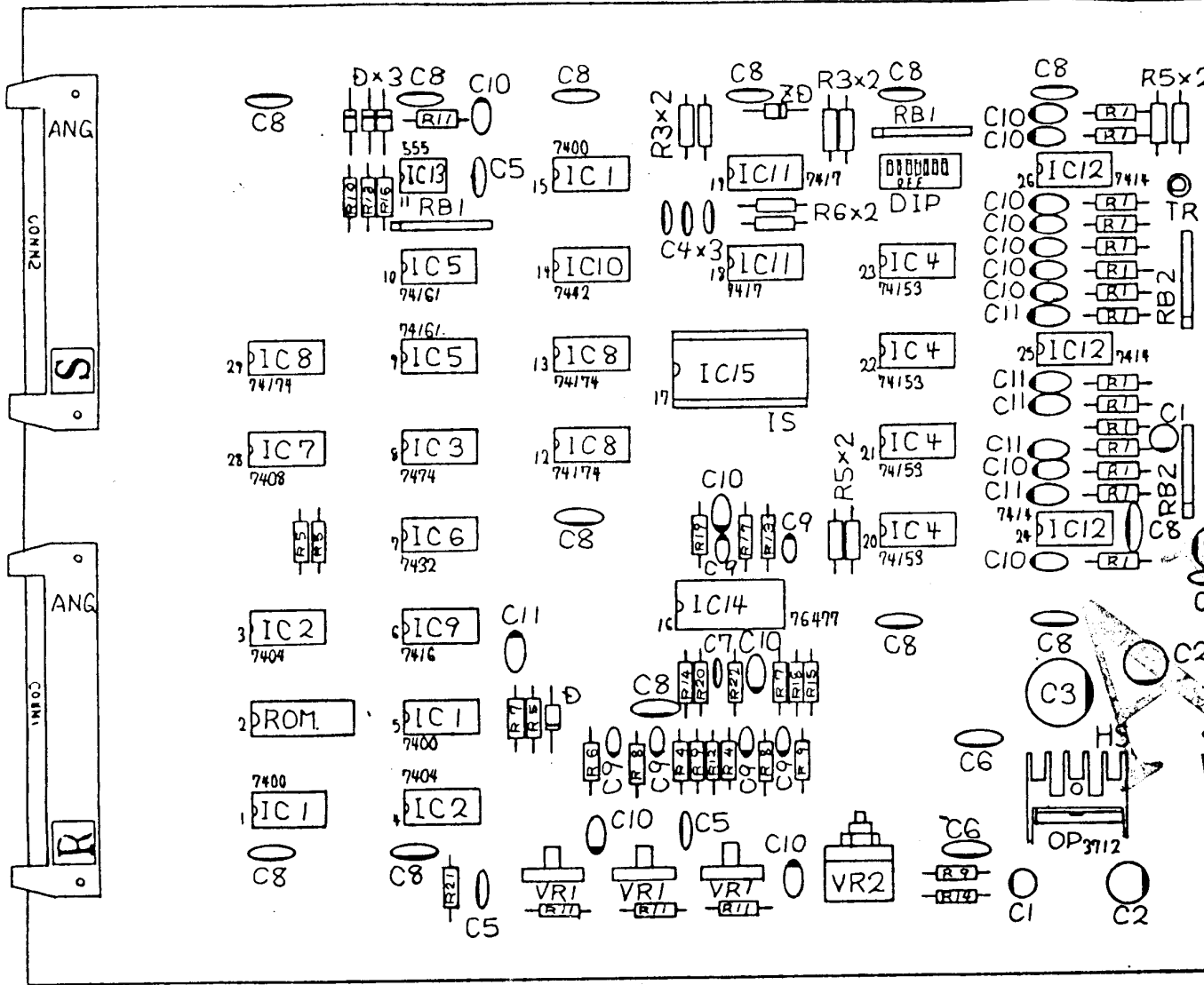

PRESS THE SERIAL NO.

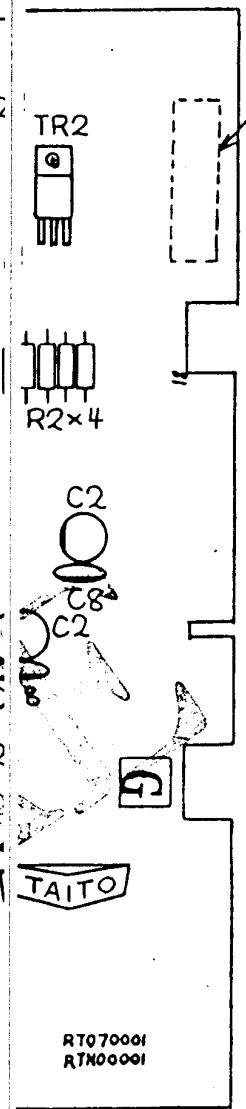

50	R 6	AAT 51772	RES., CARBON, 2KOHM 1/4W ±5%	3
49	R 5	51765	1K	7
48	R 4	51759	560	2
47	R 3	51751	270	4
46	R 2	51741	100	4
45	R 1	51737	RES., CARBON, 680HM 1/4W ±5%	15
44	C 11	41430	CAP., TANTALUM, SSG25-10F	6
43	C 10	41436	SSG35-1F	14
42	C 9	41431	TANTALUM, SSG35-OR1F	6
41	C 8	41672	CERAMIC, SC45F-1H-1042 50V	15
40	C 7	41394	CERAMIC, DT-205 470PF 50V	1
39	C 6	41244	FILM, TDY-1H-104	2
38	C 5	41238	TDY-1H-103	3
37	C 4	41232	FILM, TDY-1H-102	3
36	C 3	41040	ELECTROLYTIC, 25VB-1000	1
35	C 2	41036	25VB-100	4
34	C 1	AAT 41035	CAP., ELECTROLYTIC, 25VB-47	2
33	ROM	RT0 90006	P-ROM, RT06 (4x)	1
32	IC15	AAT 37001	CUSTOM I.C., MB14241	1
31	IC14	32141	TTL I.C., 76477	1
30	IC13	32019	NE555V	1
29	IC12	32054	7414	3
28	IC11	32049	7417	2
27	IC10	32039	7442	1
26	IC 9	32033	7416	1
25	IC 8	32029	74174	3
24	IC 7	32023	7408	1
23	IC 6	32021	7432	1
22	IC 5	32018	74161	2
21	IC 4	32017	74153	4
20	IC 3	32011	7474	1
19	IC 2	32003	7404	2
18	IC 1	AAT 32001	TTL I.C., 7400	3
17			PAN HD SCREW, M3x6	1
16	OP	AAT 31042	OP AMPLIFIER, MB3712	1
15	ZD	13028	ZENER DIODE, RD-9A	1
14	D	AAT 12025	DIODE, 1S1588	4
13			NUT, M3	1
12			PAN HD SCREW, M3x8	1
11	TR2	AAT 11030	TRANSISTOR, 2SC1061	1
10	TR1	AAT 11020	TRANSISTOR, 2SC372	1
9	IS	AAO 55787	I.C. SOCKET, 24PIN	1
8	ANG	55154	ANGLE PIN HEADER, PS-50PA	2
7	DIP	52560	DIP SWITCH, DSS-7	1
6	S	17662	CONNECTOR STICKER, S	1
5	R	17659	CONNECTOR STICKER, R	1
4	G	AAO 17632	CONNECTOR STICKER, G	1
3			PAN HD SCREW, M3x6	1
2	HS	AAO 14520	HEAT SINK	1
1		RT0 70001	RT-GAME P.C BOARD	1

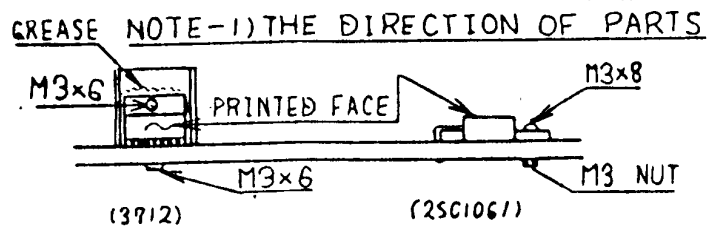
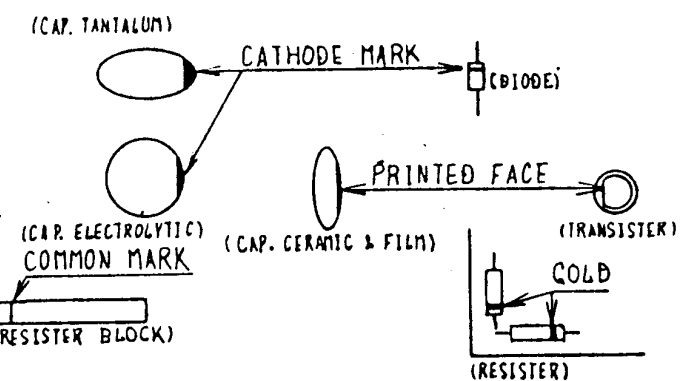

NOTE-2) HOW TO MOUNT PARTS

70	RB2	AAT 55039	RESISTOR BLOCK, 10KOHM 8elements	2
69	RB1	55036	RESISTOR BLOCK, 1KOHM 8elements	2
68	VR2	53047	VARIABLE RESISTOR, B-50K RV/6YP	1
67	VR1	53041	VARIABLE RESISTOR, B-50K	3
66	R22	51845	RES., CARBON, 2.2KOHM 1/4W ±5%	1
65	R21	51829	470K	1
64	R20	51825	330K	1
63	R19	51821	220K	1
62	R18	51820	200K	1
61	R17	51815	120K	1
60	R16	51811	82K	1
59	R15	51809	68K	1
58	R14	51805	47K	2
57	R13	51803	39K	2
56	R12	51801	33K	1
55	R11	51796	20K	4
54	R10	51793	15K	1
53	R 9	51789	10K	3
52	R 8	51785	6.8K	2
51	R 7	AAT 51782	RES., CARBON, 4.7KOHM 1/4W ±5%	2

PARTS LIST

TAITO CORPORATION
NAME: T.T. SPACE CHASER
RT-GAME P.C BOARD Assy

DATE: 8,23,79
DRAWN: Kudo
CHECK: S.
APPROVED: [Signature]

SCALE: A2
MATERIAL: RTN 00001

DO NOT SCALE DRAWING

REVISIONS			
LYR	DESCRIPTION	DATE	APPROVED
Δ	P-11-7 · 1POINT	10.9.99	Kobayashi
Δ	P-11-10 · 2POINT	10.9.99	Kobayashi
Δ	P-11-18 · 3POINT	11.5.99	Kobayashi

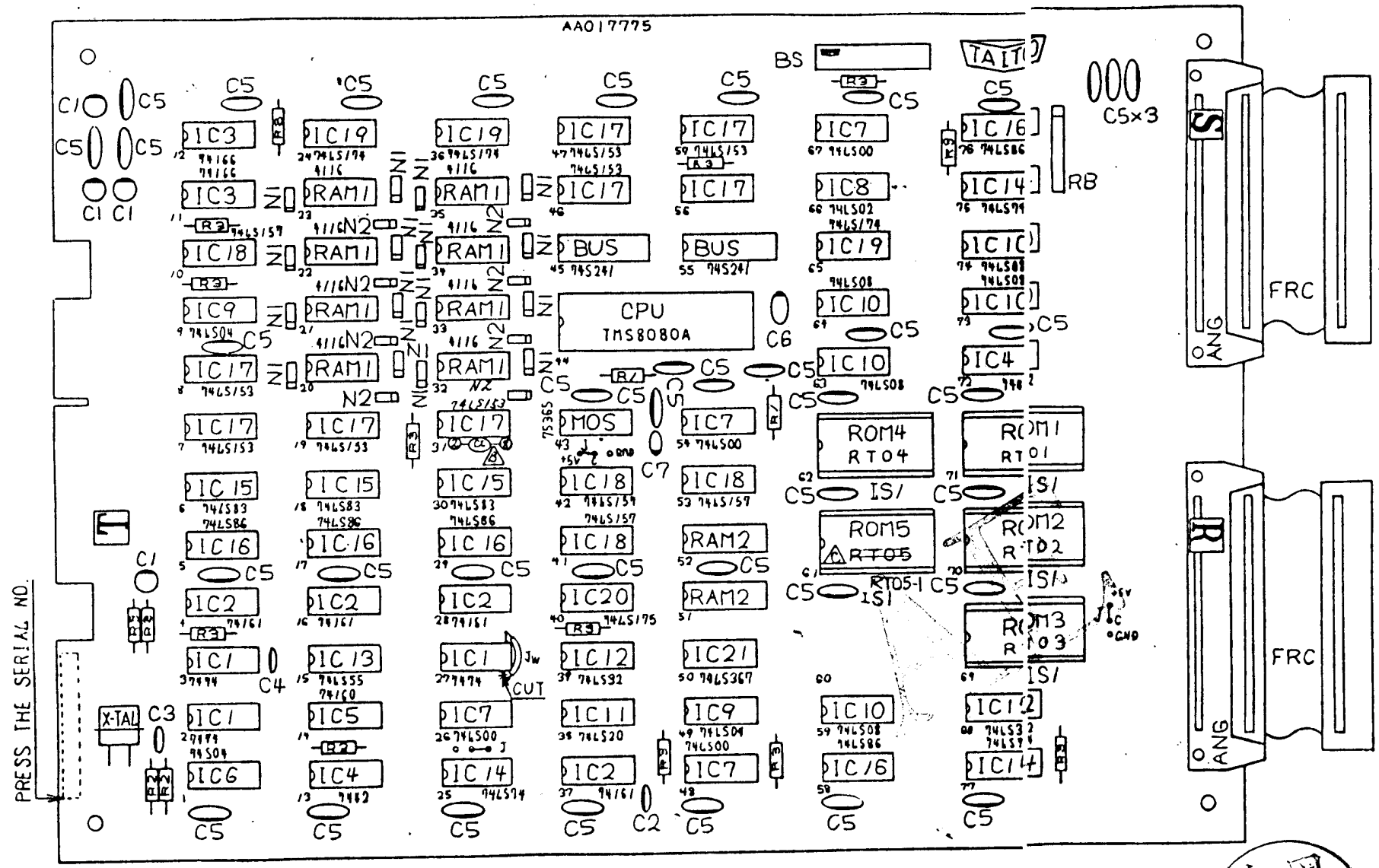

ITEM NO.	SYM	PART NO. (REVISION NO.)	NOMENCLATURE OR DESCRIPTION	QTY
50	RB	AAT 55041	RESISTER BLOCK 470ohm 8elements	1
49	R3	· 51765	RES. CARBON, 1Kohm ±5% 1/4W	15
48	R2	· 51753	· · · · · 330 · · · · ·	2
47	R1	· 51745	RES. CARBON, 150ohm ±5% 1/4W	2
46	C7	· 41425	CAP. TANTALUM, SSG25-1F	1
45	C6	· 41424	· TANTALUM, SSG16-22F	1
44	C5	· 41672	· CERAMIC, SC45FIH1042 50V 0.1uF	39
43	C4	· 41334	· · · · · DT-205 470PF 50V	1
42	C3	· 41324	· · · · · DT-203 180PF 50V	1
41	C2	· 41318	· CERAMIC, DT-201 100PF 50V	2-F
40	C1	AAT 41032	CAP. ELECTROLYTIC, 25VB-10	4
39	ROM5	RTO 90005	P-ROM, RTO5, 16K	0 F
38	ROM4	· 90004	· RTO4 · · · · ·	1
37	ROM3	· 90003	· RTO3 · · · · ·	1
36	ROM2	· 90002	· RTO2 · · · · ·	1
35	ROM1	RTO 90001	P-ROM, RTO1, 16K	1
34	MOS	AAT 35002	MOS DRIVER, SN75365	1
33	BUS	· 35001	BUS DRIVER, 74S241	2
32	CPU	· 34001	C.P.U., TMS8080A	1
31	IC21	· 33203	L.S. I.C., 74LS367	1
30	IC20	· 33128	· · · · · 74LS175	1
29	IC19	· 33127	· · · · · 74LS174	3
28	IC18	· 33112	· · · · · 74LS157	4
27	IC17	· 33108	· · · · · 74LS153	8
26	IC16	· 33062	· · · · · 74LS86	5
25	IC15	· 33059	· · · · · 74LS83	3
24	IC14	· 33051	· · · · · 74LS74	3
23	IC13	· 33043	· · · · · 74LS55	1
22	IC12	· 33027	· · · · · 74LS32	2
21	IC11	· 33019	· · · · · 74LS20	1
20	IC10	· 33009	· · · · · 74LS08	5
19	IC9	· 33005	· · · · · 74LS04	2
18	IC8	· 33003	· · · · · 74LS02	1
17	IC7	· 33001	L.S. I.C., 74LS00	4
16	RAM2	· 32156	STATIC RAM, 2114-4	2
15	RAM1	· 32153	DYNAMIC RAM, TMS4116-25	8
14	IC6	· 32003	TTL I.C., 74S04	1
13	IC5	· 32086	· · · · · 74160	1
12	IC4	· 32039	· · · · · 7442	2
11	IC3	· 32028	· · · · · 74166	2
10	IC2	· 32018	· · · · · 74161	4
9	IC1	AAT 32011	TTL I.C., 7474	3
8	X-TAL	AAO 69539	X-TAL, 19.968MHz	1
7	ISI	· 55787	I.C. SOCKET, 24PIN	5
6	ANG	· 55154	ANGLE PIN HEADER, PS-50PA	2
5	T	· 17665	CONNECTOR STICKER, T	1
4	S	· 17662	· · · · · S	1
3	R	AAO 17659	CONNECTOR STICKER, R	1
2	BS		P.C BOARD STICKER	1
1		AAO 17775	C.P.U P.C BOARD	1

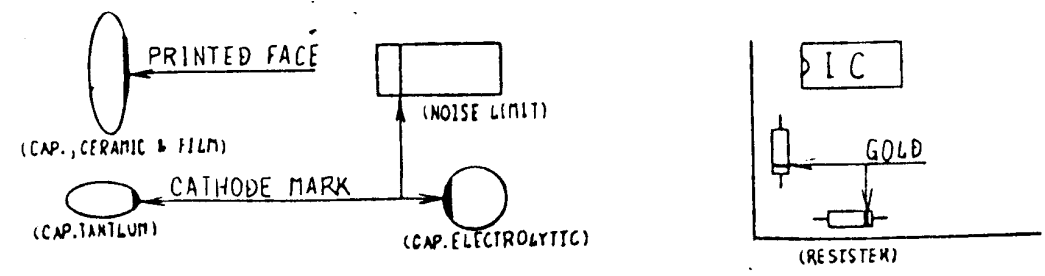

NOTE) THE DIRECTION OF PARTS

Δ 58	ROM5	RTO 90032	P-ROM	RTO 5-1	1
Δ 57		AAT 41334	CAP. CERAMIC, 470 PF (REPAIR PARTS)		1
56					
55	Jw		JUMPER WIRE	Y 100mm	
54	J		TINNED COPPER WIRE	φ200mm	
53	FRC	AAR 00215	F.R.C.-Harness Assy	50P	2
52	N2	AAT 61020	NOISE LIMIT, CS90E-1E-1R500-R58		8
51	N1	AAT 61019	NOISE LIMIT, CS90E-1A-3R300-R58		16
Part No.	SYM	PART NO. (REVISION NO.)	NOMENCLATURE OR DESCRIPTION		QTY

PARTS LIST			
THIRD ANGLE PROJECTION	DATE 7.31.99	TAITO CORPORATION	
UNLESS OTHERWISE SPECIFIED DIMENSIONS ARE IN MILLIMETERS	DESIGN Kishida	NAME T.T. SPACE CHASER	
TOLERANCES	CHECK 8/27/99	R.T. C.P.U. P.C BOARD	
GENERAL DIM. DIA. ANGLES	APPROVED	Assy	
MATERIAL	APPROVED	RTN00003	
FINISH	SCALE	CAD UNIT NO.	DWG. NO.
DO NOT SCALE DRAWING	SCALE	ISSUE DATE	SHEET

REVISIONS			
LTB	DESCRIPTION	DATE	APPROVED

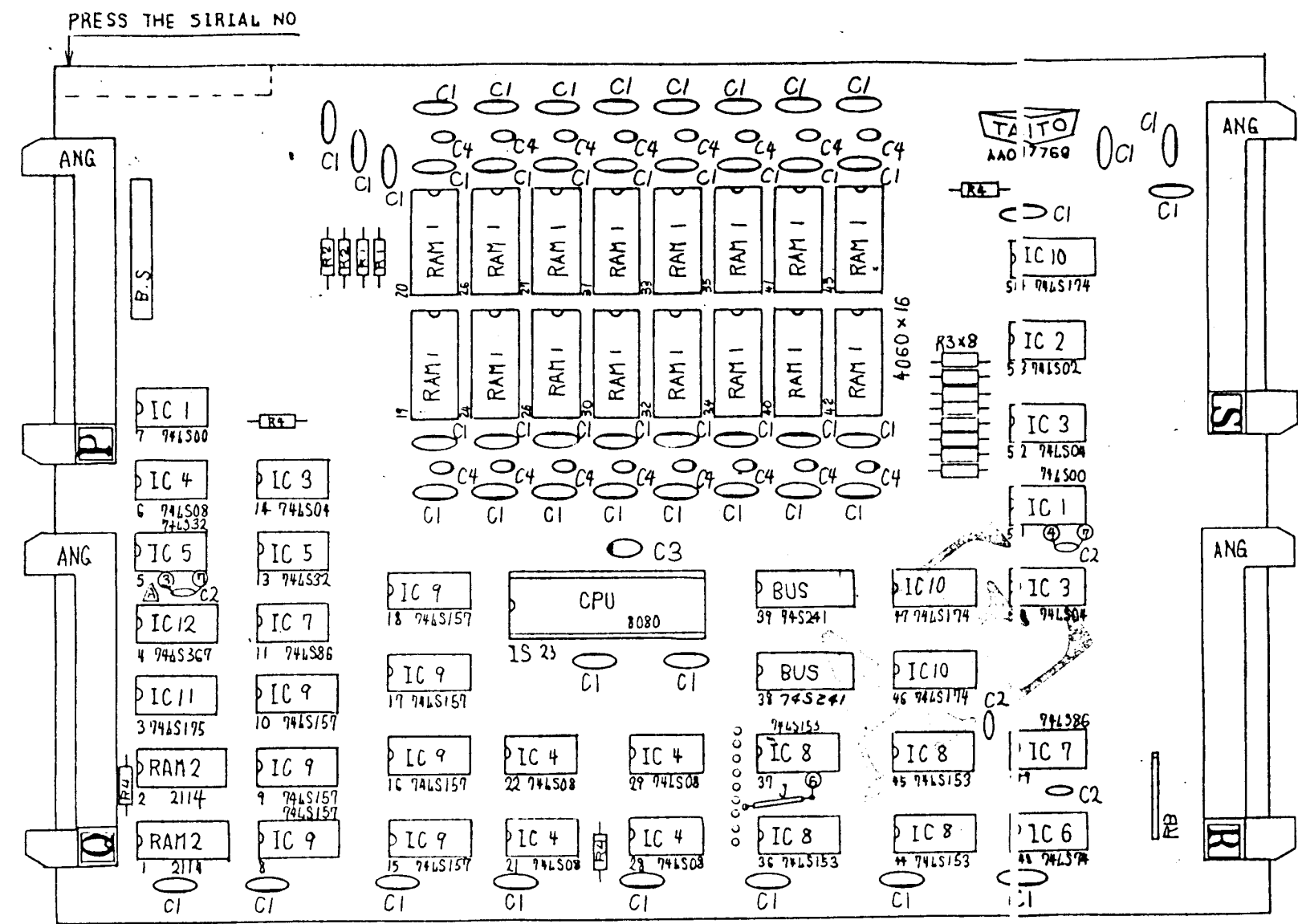

NOTE-1) PRINTED FACE

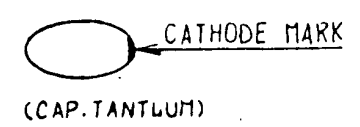

NOTE-2) CATHODE MARK

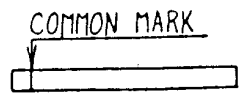

NOTE-3) RESISTOR BLOCK

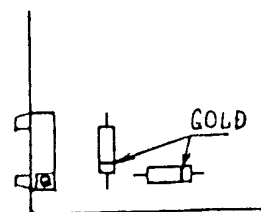

NOTE-4) RESISTOR CARBON

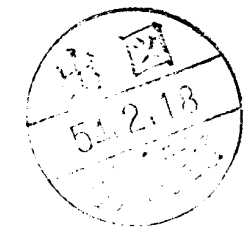

47				
46				
45				
44				
43				
42				
41				
40				
39				
38				
37				
36				
35				
34	J		JUMPER WIRE, Y 1φ 100mm	
33	RB	AAT 55041	RESISTOR BLOCK, 470ohm 8elements	1
32	R4	51765	RES. CARBON, 1Kohm 1/4W ±5%	4
31	R3	51753	330ohm	8
30	R2	51745	150ohm	2
29	R1	51729	RES. CARBON, 330ohm 1/4W ±5%	2
28	C4	41425	CAP. TANTLUM, SSG25-1F	16
27	C3	41424	TANTLUM, SSG16-22F	1
26	C2	41318	CERAMIC, DT-201 100PF 50V	34
25	C1	41244	CAP. FILM, TDY-1H-104	49
24	BUS	35001	BUS DRIVER, 74S241	2
23	CPU	34001	C.P.U, TMS8080	1
22	IC12	33203	LS I.C, 74LS367	1
21	IC11	33128	74LS175	1
20	IC10	33127	74LS174	3
19	IC9	33112	74LS157	7
18	IC8	33108	74LS153	4
17	IC7	33062	74LS86	2
16	IC6	33051	74LS74	1
15	IC5	33027	74LS32	2
14	IC4	33009	74LS08	5
13	IC3	33005	74LS04	3
12	IC2	33003	74LS02	1
11	IC1	33001	LS I.C, 74LS00	2
10	RAM2	32156	STATIC RAM, 2114N	2
9	RAM1	AAT 32091	DYNAMIC RAM, TMS4060NL(4K)	16
8	IS	AAO 55812	I.C SOCKET, 40PIN	1
7	ANG	55154	ANGLE PIN HEADER, PS-50PA	4
6	S	17662	CONNECTOR STICKER, S	1
5	R	17659		1
4	Q	17656		1
3	P	AAO 17653	CONNECTOR STICKER, P	1
2	BS	RTO 10020	P.C BOARD STICKER	1
1		AAO 17769	C.P.U P.C BOARD (B)	1

ITEM NO	SYM	PLT NO	IDENTIFYING NO	NOMENCLATURE OR DESCRIPTION	QTY
PARTS LIST					
THIRD ANGLE PROJECTION UNLESS OTHERWISE SPECIFIED DIMENSIONS ARE IN MILLIMETERS TOLERANCES		DATE 10.5.79		TAITO CORPORATION NAME T.T. SPACE CHASER R.T. C.P.U P.C BOARD (B) Assy	
DIMEN SCALE		CIRCUIT			
DRAWING		APPROVED		SCALE	
FINISH		APPROVED		DATE	
DO NOT SCALE DRAWING		SCALE		SHEET	

REVISIONS			
LTR	DESCRIPTION	DATE	APPROVED
A	3POINT - P-11-19	11/5/79	[Signature]

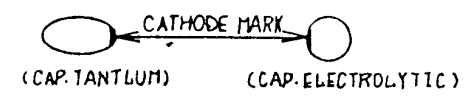
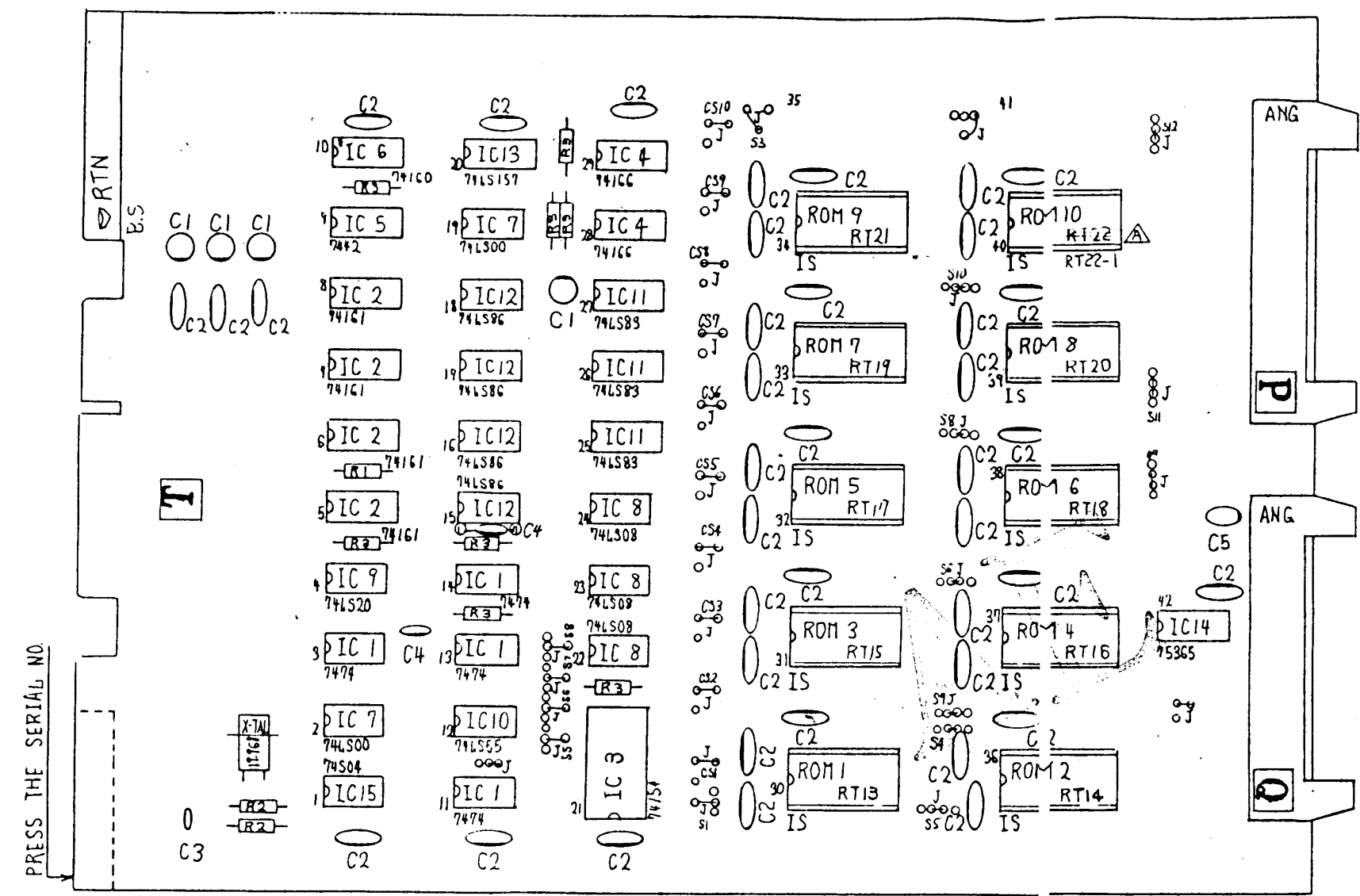

NOTE-1) CATHODE MARK

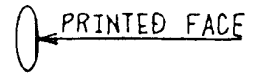

NOTE-2) CAP. CERAMIC & FILM

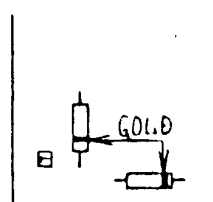

NOTE-3) RESISTER

47					
46					
45					
44					
43	ROM10	RT0 90031	P-ROM	RT22-1 (2708)	1
42	J		TINNED COPPER WIRE		200
41	R3	AAT 51765	RES. CARBON, 1K OHM, 1/4W ±5%		8
40	R2	51753	330		2
39	R1	51733	RES. CARBON, 47 OHM, 1/4W ±5%		1
38	C5	41436	CAP. TANTALUM, SSG35-1F		1
37	C4	41334	CERAMIC, DT205 470PF 50V		2
36	C3	41324	CERAMIC, DT203 180PF 50V		1
35	C2	41244	FILM, TBY-1H-10A		40
34	C1	AAT 41032	CAP. ELECTROLYTIC, 25V B-10		4
33	ROM10	RT0 90029	P-ROM	RT22 (2708)	10
32	ROM9	90028		RT21	1
31	ROM8	90027		RT20	1
30	ROM7	90026		RT19	1
29	ROM6	90025		RT18	1
28	ROM5	90024		RT17	1
27	ROM4	90023		RT16	1
26	ROM3	90022		RT15	1
25	ROM2	90021		RT14	1
24	ROM1	RT0 90020	P-ROM	RT13 (2708)	1
23	IC15	AAT 38003	S I.C.	74S04	1
22	IC14	35002	MOS DRIVER	75365	1
21	IC13	33112	LS I.C.	74LS157	1
20	IC12	33062		74LS86	4
19	IC11	33059		74LS83	3
18	IC10	33043		74LS55	1
17	IC9	33019		74LS20	1
16	IC8	33009		74LS08	3
15	IC7	33001	LS I.C.	74LS00	2
14	IC6	32086	TTL I.C.	74160	1
13	IC5	32039		7442	1
12	IC4	32028		74166	2
11	IC3	32027		74154	1
10	IC2	32018		74161	4
9	IC1	AAT 32011	TTL I.C.	7474	4
8	X-TAL	AAO 69539	X-TAL	19.968MHz	1
7	IS	55787	I.C. SOCKET	24P	10
6	ANG	55154	ANGLE PIN HEADER	PS-50PA	2
5	T	17665	CONNECTOR STICKER	T	1
4	Q	17656		Q	1
3	P	AAO 17653	CONNECTOR STICKER	P	1
2	BS	RT0 70019	P.C BOARD STICKER		1
1		AAO 17768	C.P.V P.C BOARD	A	1

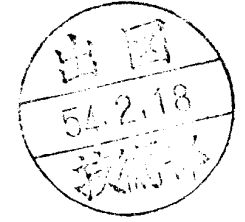

PARTS LIST			
VIEW NO.	SYM	PART OR IDENTIFYING NO.	NOMENCLATURE OR DESCRIPTION
<p>THIRD ANGLE PROJECTION UNLESS OTHERWISE SPECIFIED DIMENSIONS ARE IN MILLIMETERS TOLERANCES</p> <p>GENERAL HOLE DIA ANGLES</p> <p>MATERIAL</p> <p>FINISH</p> <p>APPROVED</p> <p>DO NOT SCALE DRAWING</p>			
<p>DATE: 10.5.79</p> <p>DESIGN: Kichota</p> <p>CHECK: 10.8.79</p>		<p>TAITO CORPORATION</p> <p>NAME: T.T. SPACE CHASER</p> <p>R.T CPU P.C BOARD (A) Assy</p> <p>APP. NO. AZ</p> <p>DATE: RTN00004</p>	

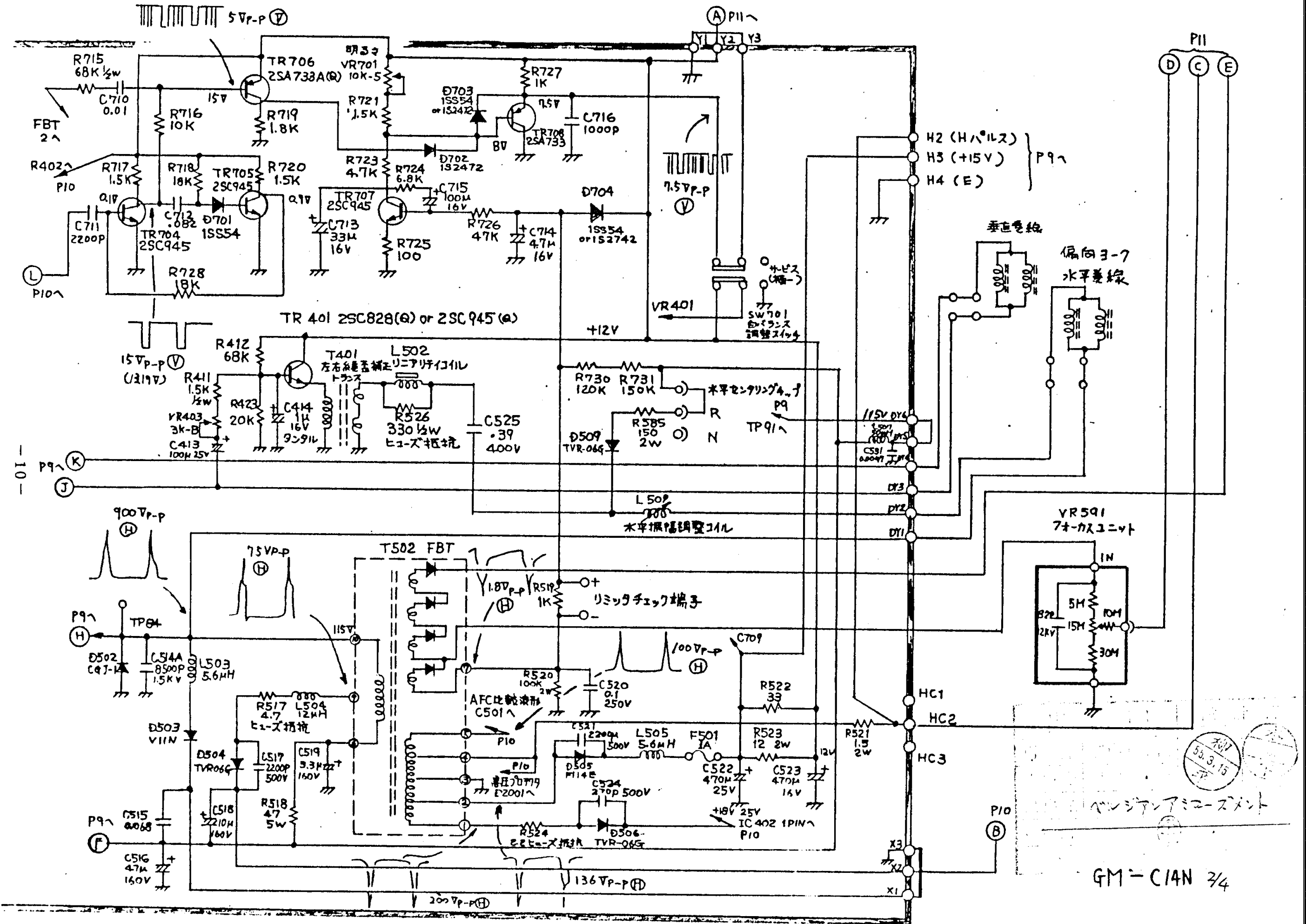

- 10 -

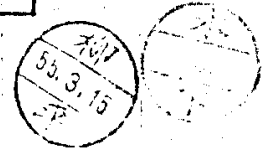

位置調整シート

GM-C14N 3/4

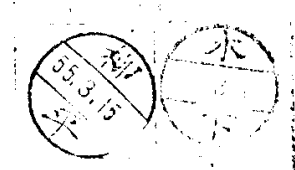
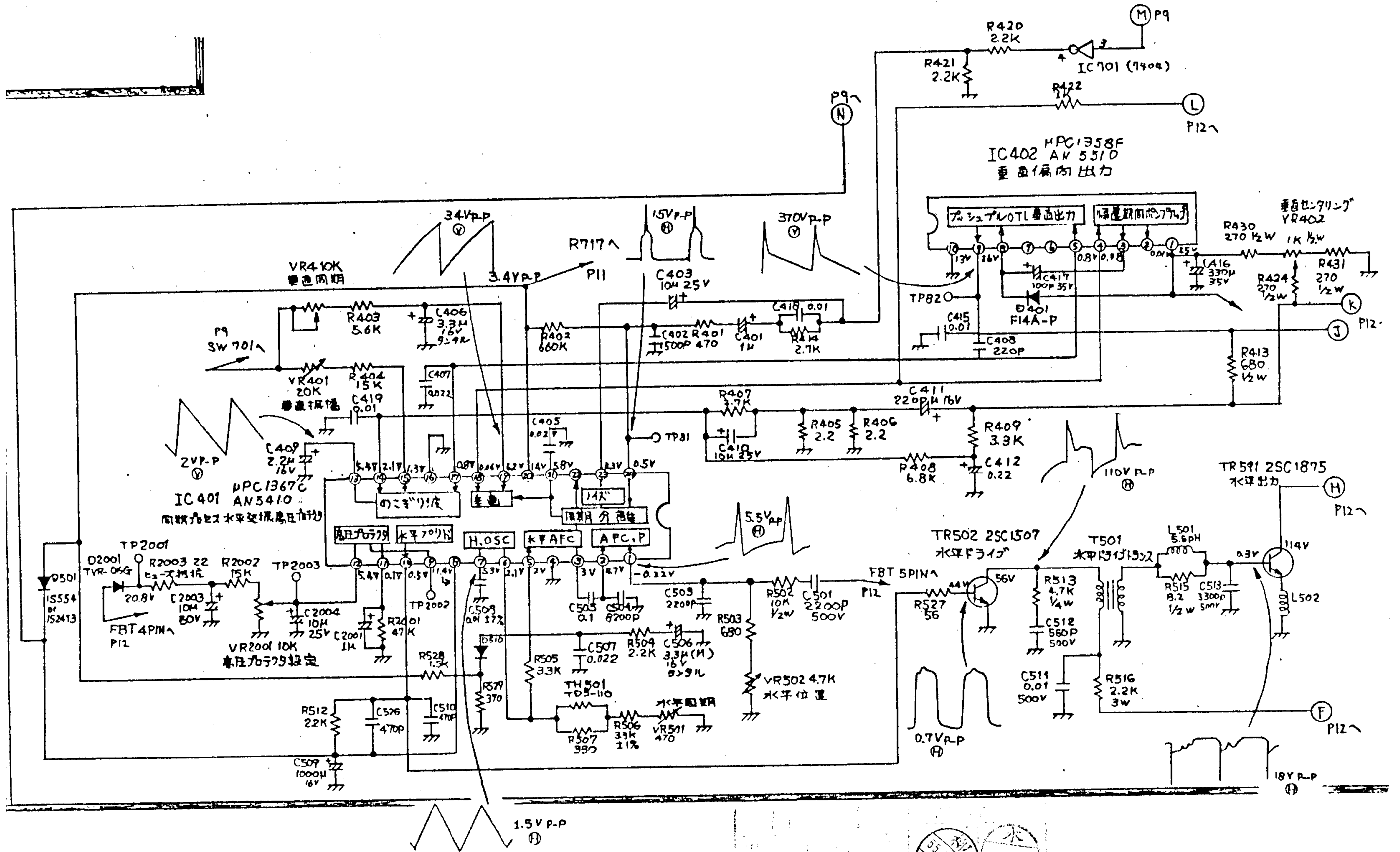

水平同期

GM-C14N 3/4

