



TM-338
1st printing

Operator's Manual

with Illustrated Parts Lists



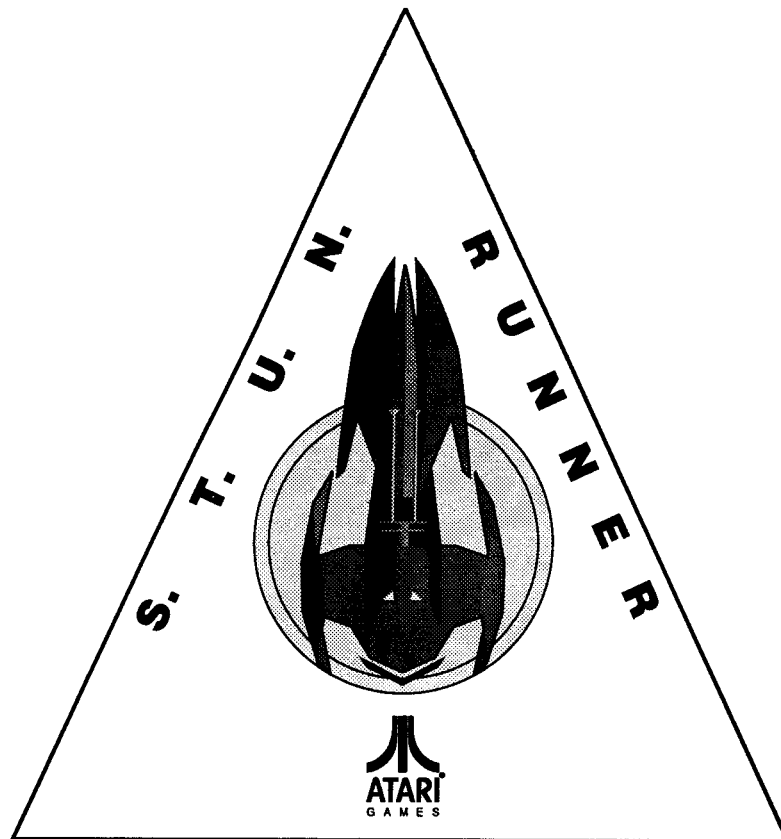

Operator's Manual

Copyright © 1989 by Atari Games Corporation. All rights reserved.

No part of this publication may be reproduced by any mechanical, photographic or electronic process, or in the form of a phonographic recording, nor may it be stored in a retrieval system, transmitted, or otherwise copied for public or private use, without permission from the publisher.

The game play, all graphic designs, this technical manual, its accompanying schematic diagrams, and the display manual are protected by the U.S. Copyright Act of 1976.

This Act provides for substantial penalties for violating federal copyright laws. Courts can impound infringing articles while legal action is pending. If infringers are convicted, courts can order destruction of the infringing articles.

In addition, the Act provides for payment of statutory damages of up to \$50,000 per infringing transaction in certain cases. Infringers may also have to pay costs and attorneys' fees and face an imprisonment of up to five years as well as fines of up to \$250,000 in the case of individuals and up to \$500,000 in the case of corporations.

Atari Games Corporation will aggressively enforce its copyrights against infringers. We will use all legal means to immediately halt any manufacture, distribution, or operation of a copy of video games made by us. Anyone who purchases such copies risks forfeiting such a game.

Published by:
Atari Games Corporation
675 Sycamore Drive
P.O. Box 361110
Milpitas, California 95035

Printed in the U.S.A **9/89**

Produced by the Atari Games Technical Publications Department.

Editing: Andrea Dencker
Illustration and Design: Mary Ohanessian Sumner

Notice Regarding Non-Atari® Parts

WARNING

Use of non-Atari parts or modifications of any Atari game circuitry may adversely affect the safety of your game, and may cause injury to you and your players.

You may void the game warranty (printed on the inside back cover of this manual) if you do any of the following:

- Substitute non-Atari parts in the game.
- Modify or alter any circuits in the game by using kits or parts *not* supplied by Atari Games Corporation.

NOTE

This equipment generates, uses, and can radiate radio frequency energy, and if not installed and used in accordance with the instruction manual, may cause interference to radio communications. It has been tested and found to comply with the limits for a Class A computing device pursuant to Subpart J of Part 15 of Federal Communications Commission (FCC) Rules, which are designed to provide reasonable protection against such interference when operated in a commercial environment. Operation of this equipment in a residential area or modification to this equipment is likely to cause interference, in which case the user, at his own expense, will be required to take whatever measures may be required to correct the interference. If you suspect interference from an Atari game at your location, check the following:

- All ground wires in the game are properly connected as shown in the game wiring diagram.
- The power cord is properly plugged into a grounded three-wire outlet.
- On games provided with an Electromagnetic Interference (EMI) ground cage, be sure that the game printed-circuit boards (PCBs) are properly installed on the EMI ground cage and that the end board is securely installed with **all** screws in place and tightened.

If you are still unable to solve the interference problem, please contact Customer Service at Atari Games Corporation. See the inside front cover of this manual for service in your area.

Contents

1 Set Up

How to Use This Manual	1-1
Inspecting the Game	1-2
Control and Switch Locations	1-2
Setting the Coin and Game Options.....	1-3
Game Systems	1-3
Maximizing Earnings	1-3
Game Play.....	1-3

2 Self-Test and Diagnostics

Entering and Exiting the Self-Test	2-2
Automated Self Test	2-2
Program ROM and RAM Test.....	2-3
Microprocessor and Board Tests.....	2-3
Test Menu Screens	2-3
Operator Screens	2-4
Coin Options.....	2-4
Game Options.....	2-5
Statistics	2-5
Histograms	2-7
Error Count	2-9
Control Inputs Screen	2-9
Monitor Test Patterns	2-9
Special Functions Screen	2-10
Main Board GSP Tests	2-10
Main Board ROM Checksums	2-11
Main Board ZRAM Test	2-11
ADSP Board Tests	2-11
Audio Board.....	2-12
LEDs on the Main PCB	2-12
DIP Switches	2-13

3 Maintenance and Troubleshooting

Maintaining and Inspecting	3-2
Coin Mechanism	3-2
Maintaining the Coin Mechanism	3-2
Interior Components	3-2
Cleaning the Interior Components	3-2
Video Display	3-3
Adjusting the Video Display	3-3
Removing the Video Display	3-3
Replacing the Video Display	3-4
Flight Control Maintenance	3-5
Routine Maintenance	3-5
Removing the Flight Control Assembly	3-5
Disassembling the Handle Assembly.....	3-5
Reassembling the Handle Assembly.....	3-6
Disassembling the Flight Control Assembly	3-7
Reassembling the Flight Control Assembly	3-7
Installing the Harness Assembly	3-10

4 Illustrated Parts Lists

See the List of Illustrations that follows.

Statistics Sheet

Illustrations

Figure 1-1	Control and Switch Locations	1-2	Figure 2-18	ROM Checksums Screen	2-11
Figure 2-1	Program ROM and RAM Test Screen..	2-3	Figure 2-19	ADSP Board Tests Screen.....	2-11
Figure 2-2	Microprocessor and Board Tests Screen.....	2-3	Figure 2-20	ADSP ROM Checksums Tests Screen	2-12
Figure 2-3	Instructions for Test Menu Screen	2-4	Figure 2-21	SA Audio Test Screen	2-12
Figure 2-4	Test Menu Screen	2-4	Figure 2-22	DIP Switch and LED Locations on the Main PCB	2-13
Figure 2-5	Coin Options Screen	2-4	Figure 3-1	Removing the Video Display	3-4
Figure 2-6	Game Options Screen	2-5	Figure 3-2	Flight Control Assembly	3-8
Figure 2-7	Statistics Screen.....	2-7	Figure 3-3	Flight Control Removal.....	3-10
Figure 2-8	First Histogram Screen	2-8	Figure 4-1	Cabinet-Mounted Assemblies.....	4-2
Figure 2-9	Second Histogram Screen	2-8	Figure 4-2	Flight Control Assembly	4-6
Figure 2-10	Third Histogram Screen.....	2-8	Figure 4-3	Coin Acceptors, Inc. Coin Door Assembly	4-9
Figure 2-11	Fourth Histogram Screen.....	2-8	Figure 4-4	Power Supply Assembly.....	4-11
Figure 2-12	Fifth Histogram Screen.....	2-8	Figure 4-5	S.T.U.N. Runner Multisync (Main) PCB Assembly.....	4-15
Figure 2-13	Sixth Histogram Screen	2-8	Figure 4-6	ADSP II PCB Assembly.....	4-19
Figure 2-14	Error Counts Screen.....	2-9	Figure 4-7	Stand-Alone Audio II PCB Assembly...	4-21
Figure 2-15	Control Inputs Screen	2-9			
Figure 2-16	Special Functions Screen.....	2-10			
Figure 2-17	GSP Tests Screen	2-10			

Tables

Table 1-1	Game Specifications	1-2	Table 2-6	LED Status	2-13
Table 2-1	Using the Self-Test Screens and Diagnostics	2-2	Table 2-7	Using the DIP Switches	2-14
Table 2-2	Coin Option Settings	2-5	Table 3-1	Maintenance and Inspection Items.....	3-2
Table 2-3	Game Option Settings	2-5	Table 3-2	Voltage Inputs and Test Points on the Game PCBs.....	3-2
Table 2-4	Summary of All Screens Appearing in the Self-Test	2-6	Table 3-3	Troubleshooting the Video Display.....	3-3
Table 2-5	When to Use the Special Function Items	2-11			

Safety Summary

The following safety precautions apply to all game operators and service personnel. Specific warnings and cautions will be found in this manual whenever they apply.

WARNING

Properly Ground the Game. Players may receive an electrical shock if this game is not properly grounded! To avoid electrical shock, do not plug in the game until it has been inspected and properly grounded. This game should only be plugged into a grounded three-wire outlet. If you have only a two-wire outlet, we recommend you hire a licensed electrician to install a three-wire grounded outlet. If the control panel is not properly grounded, players may receive an electrical shock! After servicing any part on the control panel, check that the grounding wire is firmly secured to the inside of the control panel. After you have checked this, lock up the game.

AC Power Connection. Before you plug in the game, be sure that the game's power supply can accept the AC line voltage in your location. The line voltage requirements are listed in the first chapter of this manual.

Disconnect Power During Repairs. To avoid electrical shock, disconnect the game from the AC power before removing or repairing any part of the game. If you remove or repair the video display, be very careful to avoid electrical shock. High voltages continue to exist even after power is disconnected in the display circuitry and the cathode-ray tube (CRT). Do not touch the internal parts of the display with your hands or with metal objects! Always discharge the high voltage from the CRT before servicing it. Do

this after you disconnect it from the power source.

First, attach one end of a large, well-insulated, 18-gauge jumper wire to ground. Then momentarily touch the free end of the grounded jumper wire to the CRT anode by sliding the wire under the anode cap. Wait two minutes and do this again.



Use Only Atari Parts. To maintain the safety of your Atari game, use only Atari parts when you repair it. Using non-Atari parts or modifying the game circuitry may be dangerous, and could injure you and your players.

Handle the CRT With Care. If you drop the CRT and it breaks, it may implode! Shattered glass from the implosion can fly six feet or more.

Use the Proper Fuses. To avoid electrical shock, use replacement fuses which are specified in the parts list for this game. Replacement fuses must match those replaced in fuse type, voltage rating, and current rating. In addition, the fuse cover must be in place during game operation.

CAUTION

Properly Attach All Connectors. Make sure that the connectors on each printed circuit board (PCB) are properly plugged in. The connectors are keyed to fit only one way. If they do not slip on easily, do not force them. If you reverse a connector, it may damage your game and void your warranty.

Ensure the Proper AC Line Frequency. Video games manufactured for operation on 60 Hz line power (used in the United States) must not be operated in countries with 50 Hz line power (used in Europe). If a 60 Hz machine operates on 50 Hz line power, the fluorescent line ballast transformer will overheat and cause a potential fire hazard. Check the product identification label on your machine for the line frequency required.

ABOUT NOTES, CAUTIONS, AND WARNINGS

In Atari publications, notes, cautions, and warnings have the following meaning:

NOTE — A highlighted piece of information.

CAUTION — Equipment and/or parts can be damaged or destroyed if instructions are not followed. You will void the warranty on Atari printed-circuit boards, parts thereon, and video displays if equipment or parts are damaged or destroyed due to failure of following instructions.

WARNING — Players and/or technicians can be killed or injured if instructions are not followed.

N O T E S

SET-UP

Chapter 1

How to Use This Manual

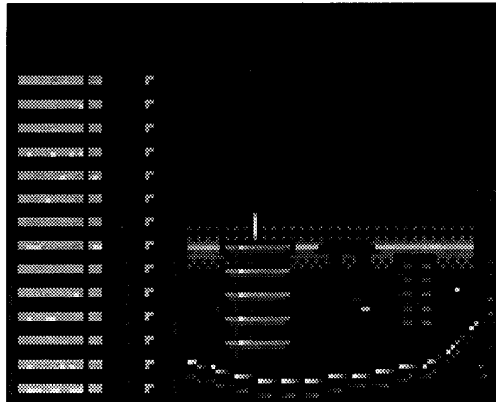

This manual is written for operators and service personnel. It provides information for setting up, playing, testing, and maintaining your S.T.U.N. (Spread Tunnel Underground Network) Runner™ game.

The manual is divided into the following chapters:

- Chapter 1 contains set-up and game playing information.
- Chapter 2 contains self-test procedures and additional diagnostic tests. The self-test is important in the S.T.U.N. Runner game. You can troubleshoot the PC

boards, main circuits, and controls using the many screens in the self-test. You

should regularly test the boards and controls with the self-test to keep your game in peak condition and at top earnings.

- Chapter 3 contains maintenance, repair, and troubleshooting information for your S.T.U.N. Runner game. Be sure to perform the preventive maintenance tasks to keep the game in good condition.
- Chapter 4 contains the illustrated parts lists.

Inspecting the Game

WARNING

To avoid electrically shocking yourself and damaging the game electronics, do not plug in the game until it has been inspected and set up for your line voltage.

This cabinet should be connected to a grounded three-wire outlet only. If you have only two-wire outlets, we recommend that you hire a licensed electrician to install grounded outlets. Players can receive an electrical shock if the cabinet is not properly grounded.

Inspect your S.T.U.N. Runner game carefully to ensure that the game is complete and was delivered to you in good condition.

Inspect the cabinet as follows:

1. Examine the exterior of the cabinet for dents, chips, or broken parts.
2. Open the service door. Unlock and open the coin doors. Inspect the interior of the cabinet as follows:
 - a. Check that all plug-in connectors on the cabinet harnesses are firmly plugged in. Do not force connectors together. The connectors are keyed so they fit only in the proper orientation. A reversed connector can damage a printed-circuit board (PCB). This will void your warranty.
 - b. Ensure that all plug-in integrated circuits on each PCB are firmly plugged into their sockets.
 - c. Inspect the power cord for any cuts or dents in the insulation.
 - d. Inspect the power supply. Make sure that the correct fuses are installed. Check that the harness is plugged in correctly and that the fuse block cover is mounted in place. Check that the green ground wires are connected.
 - e. Inspect other sub-assemblies, such as the video display, controls, printed-circuit boards (PCBs), and speakers. Make sure that they are mounted securely and that the ground wires are connected.

Control and Switch Locations

Most of the controls are located inside the seat, behind the coin door (see Figure 1-1). The only exception is the power on/off switch.

Power On/Off Switch

The power on/off switch is located at the center rear of the cabinet.

Table 1-1 Game Specifications

Characteristic	Specification
Power Consumption	160 W maximum
Line Fuse Rating	2 Amps
Line Voltage	102 to 132 VAC
Temperature	5° to 38° C (37° to 100° F)
Humidity	Not to exceed 95% relative
Width	25.5 in. (67.7 cm.)
Depth	67 in. (170 cm.)
Height	66.5 in. (169 cm.)
Weight	350 lbs. (159 kg.)

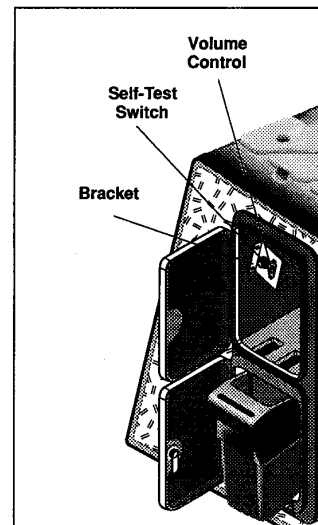

Figure 1-1 Control and Switch Locations

Volume Control

The volume control is located behind the upper coin door under the seat.

Self-Test Switch

The self-test switch is located behind the upper coin door under the seat. See Chapter 2 for a complete description of the self-test.

Coin Counter

The coin counter is located behind the lower coin door underneath the coin tray. The coin counter records the number of coins deposited.

Setting the Coin and Game Options

The S.T.U.N. Runner coin and game options are set in the self-test. Refer to Chapter 2 for the recommended settings and the procedure for setting the options.

Game Systems

The S.T.U.N. Runner game uses four PCBs to give a realistic look and feel to the driving. These PCBs are the multisync main PCB, the ADSP PCB, the audio PCB, and the video display board.

The multisync main PCB, which is the largest, holds the 68010 and the GSP microprocessor systems. The 68010 system contains program RAM and ROM. The GSP (Graphic Systems Processor) microprocessor system controls the video RAMs (VRAMs). The ADSP board is mounted with the multisync main PCB.

Maximizing Earnings

Operator options on this game have been kept very simple. You should thoroughly read Chapter 2, Self-Test for information on the Coin Options, Game Options, Histograms, and Statistics screens so that you can effectively use the available options. Use the Self-Test screens showing Statistics and Histograms to evaluate game data, and the Game Options screen to make adjustments. (Refer also to the Self-Test chapter for more information on setting options.)

The key to maximizing earnings is striking a midpoint on game times. Game times must be short enough so that player turnover is high. Conversely, game times must be long enough to give players a good value and

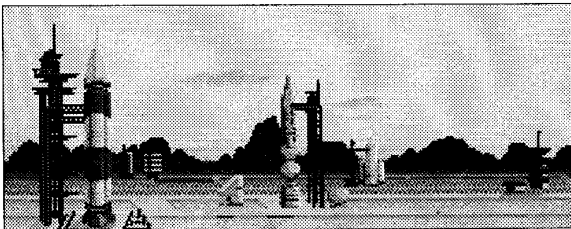

ensure repeat play. (Repeat play is crucial to longevity.) The S.T.U.N. Runner software gives the operator the flexibility to tune game difficulty and enough statistics to intelligently make adjustments.

If collections seem low or are dropping off, check player controls and coin mechanisms for proper operation.

If earnings seem low, the game is technically sound, and the average game time per credit is under 150 seconds, choose an easier difficulty level.

NOTE

The statistics show average time per coin. Depending on the Coin Option settings, the average time per game (or credit) can be computed from the Total Credits, Total Coins, and Average Time/Coin as follows:

*Avg Time per Credit = Avg Time per Coin
× Total Coins ÷ Total Credits.*

One of the game option settings ("Continue Advances to Next Level") can help you maximize earnings. In addition, you can change the price of continuations.

After changing game option settings, it is a good idea to reset the game statistics and the histograms. The game statistics can be cleared in the self-test on the second statistics screen by moving the left joystick and pressing any left player button. The histograms can be cleared by moving the left joystick and pressing any left player button while you are on the histogram screen.

Game Play

This section of the manual describes the theme of the S.T.U.N. Runner game and the game play features.

Introduction

Take a seat, grasp the controls, and enter the world of the S.T.U.N. (Spread Tunnel Underground Network) Runner. Players travel ahead in time to the 21st century and experience the thrill of racing in a futuristic form of competitive driving. At the control of state-of-the-art technology, players pilot a billion-dollar vehicle capable of attaining speeds of over 900 miles per hour!

Players control their vehicles with a return-to-center (RTC) flight controller. Control handles adjust shot elevation and include trigger buttons for firing. The start button is also used as a fire button for "shock waves."

Play Mode

S.T.U.N. Runner is a game of speed. The goal of this game is to travel as fast as possible and complete each race within the allotted time. Numerous enemies prevent the player from achieving this goal. Equipped with powerful lasers, all enemies can be gunned down with the exception of one.

The race through the S.T.U.N. Network is made up of many levels. Each level presents a unique challenge to the player. The player's ultimate goal is to guide the vehicle through the network of levels to reach the "Ultimate Challenge." In this never-ending race, players go

as far as their driving skills will take them. If the distance they travel qualifies as one of the top five, their name (18 letters) will be displayed along the road for future players to see (only if they reach this distance).

In S.T.U.N. Runner, there is no foot pedal to control speed. Faster speed is achieved by:

- Correctly driving on the fastest portion of the tunnel
- Staying off side rails (on flat sections)
- Avoiding collisions with enemy vehicles
- Running over “boosts” for hyperspeed
- Avoiding areas under construction

In a turn, the fastest portion of the tunnel is the outer wall. Like a luge or bobsled racer, players use the basic laws of physics to attain the fastest speed. Riding on the inner wall results in a slower speed and hinders a player's ability to reach a finish line. On flat sections, running into side rails creates a visual and audio chattering resulting in a loss of speed. The first race, a training race, called “Cake Walk,” is intended to teach players how to drive correctly.

Red flashing markers in tunnels and flats are called “boosts.” By running over these, the S.T.U.N. Runner gets a boost of hyperspeed. In addition to reaching the finish line faster, a S.T.U.N. Runner in boost is invincible. The vehicle can pass through all enemy vehicles unharmed and cannot be shot. In this mode the player's vehicle will appear transparent as though it is a skeleton.

The underground network has three different tunnel sections. They include wide tunnels, narrow tunnels, and tunnels under construction. Under construction sections contain portions that are unsurfaced. These areas do not provide full power to the vehicle, and slow down the S.T.U.N. Runner.

Open areas are called “flats” and are both narrow and wide. Being above the ground, the player is treated to many views of the earth's surface in the 21st century. On flats, players must avoid driving along the side rails. The friction caused will slow down the S.T.U.N. Runner vehicle.

A S.T.U.N. Runner vehicle has six shields for added protection. Colliding with an enemy results in the loss of one shield. At the end of each race, players are awarded bonus points for each shield remaining. A large bonus is awarded if all shields are intact.

In the tunnels and flats are ramps. These ramps will catapult S.T.U.N. Runners above the track for a brief distance. Ramp jumping is often a good method of crossing areas under construction and avoiding collisions with enemies.

When players do not reach the finish line of a race within the allotted time, the game would normally end. However, they can be allowed to advance to the next

level on a continuation. The game option setting *Continue Advances to Next Level* lets you choose whether players advance after 1 or 2 retries, or always, or never.

Special Weapon: In selected races, a “shock wave” is located along the way. If the player can pick up the shock wave, the weapon becomes available for use. Also, shock waves can be awarded on some levels if the player hits a predetermined number of stars *and* completes the level. This information is green in the map at the start of each level.

Players activate the shock wave by pressing the start button. This super weapon will destroy all enemies and hazards within view. It is a one-time weapon, but more than one can be stored. The number of shock waves stored is shown as blue and white icons on the screen below the level number display.

Bonus Stars: Additional points can be scored along the way by running over “stars.” In the first race, the training race called “Cake Walk,” the stars are red. Players should run over as many stars as possible. In the remainder of the game, all bonus stars are green.

Challenge Races: These are bonus races awarded to players for reaching various points in the game. Races 5, 10, and 15 are challenge races. Each presents a unique challenge to the player.

- Boost Challenge
- Star Challenge
- Kill Challenge

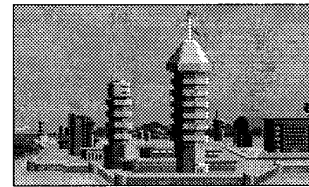

In each challenge race, players have one goal. Instructions are displayed

prior to the start of each race. The timer clock still operates, but a game will not end because the time expires. This is considered a free bonus for players. Each challenge level has its own high score table.

Ultimate Challenge: For those players skillful and patient enough, an “Ultimate Challenge” awaits them at the end. It is an endless race filled with enemies and unexpected surprises. The object is to travel as far as possible within the allotted time. Markers on the road display the names of the five best S.T.U.N. Runners. It is a unique method of identifying the best players of the game. These names are also presented on a separate high score table.

Special Contest Feature: Every S.T.U.N. Runner game in the U.S. has a special built-in contest feature. A player can win a free S.T.U.N. Runner T-shirt just for playing the game. All players have to do is reach the checkpoint in the last level, the *Ultimate Challenge*. For more contest details, see the game.

SELF-TEST & DIAGNOSTICS

Chapter 2

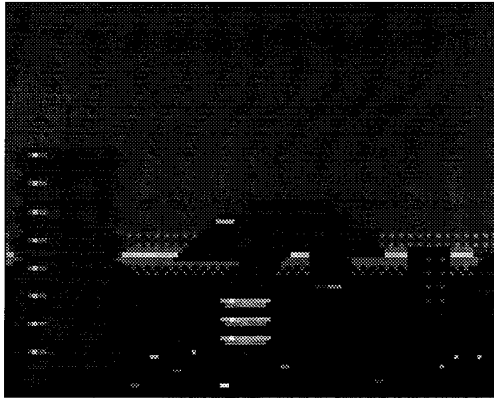

The S.T.U.N. Runner game is a complex machine. To keep it at peak efficiency and maximum earnings, you should regularly check the controls, RAMs, ROMs, PCBs, and microprocessor systems. You can check all of these when you switch on the self-test. Also in the self-test, you can check the video display and the statistics.

If you cannot use the self-test because the screen is dark, you can use a DIP switch on the main PCB to find the source of the problem. If you are having electronic problems, you can check the state of various signals with the LEDs on the main PCB.

You should regularly check the following screens and information. We recommend you check these when you first set up the game, each time you collect money, or when the game is not working correctly.

- Use the automated self-test, which begins automatically when you turn on the self-test to test the program RAMs and ROMs, the video RAMs, color RAMs, the ADSP PCB, and the sound PCB. The test

takes about five minutes to run.

- Check the *Control Inputs* screen, which you choose from the *Test Menu* screen. This shows the voltage input to the main PCB from the controller potentiometers, trigger switches, and the coin mechanisms. With this information you can easily check how the controls are working.
- Check the *Statistics* and *Histograms* screens which show the statistical information about how your game is played.

Table 2-1 shows what tests and screens to use at different times and for different problems.

Program ROM and RAM Test

When you enter self-test, the game tests the program ROM and RAM. The screen in Figure 2-1 shows the results of a program ROM and RAM test.

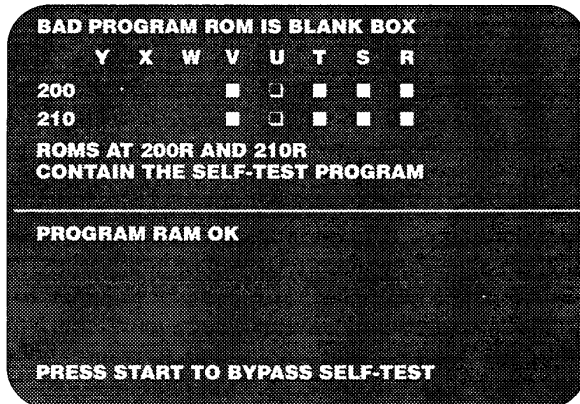

Figure 2-1 Program ROM and RAM Test Screen

The top of the screen shows the ROM test result. The numbers on the left and the letters at the top of the screen show the locations of the ROMs on the main PCB. If a white box appears, then the ROM at that location is good. If an empty box appears (as shown at 200U and 210U), then the ROM there is bad. If nothing appears, then nothing was tested there.

The RAMs are tested after the ROMs. If the RAMs have no errors, then you see the message *Program RAM OK*. If the test finds an error, then you see *Bad Program RAM At* with the bad RAM location listed.

This screen disappears after a few seconds and the self-test continues. However, the screen with the results of the complete self-test, shown in Figure 2-2, will show the message *Bad Program ROM* (or *Bad Program RAM*) if it found an error in the program ROMs or RAMs.

Microprocessor and Board Tests

After checking the program RAM and ROM, the automated self-test checks the game's microprocessor and PC boards. It tests the video RAM and color RAM in the GSP microprocessor system, the ADSP board, and the sound board. The test takes four to five minutes. You will see the screen in Figure 2-2 when it finishes.

If the system or board is good, *OK* follows the test name. If it is bad, the word *Bad* precedes the name of the board or system (except for the ADSP board test, which gives more information). If you have a bad sys-

tem or board, then choose *Special Functions* from the test menu, choose the appropriate system or board tests from the special functions menu, and read the description of the tests in this chapter.

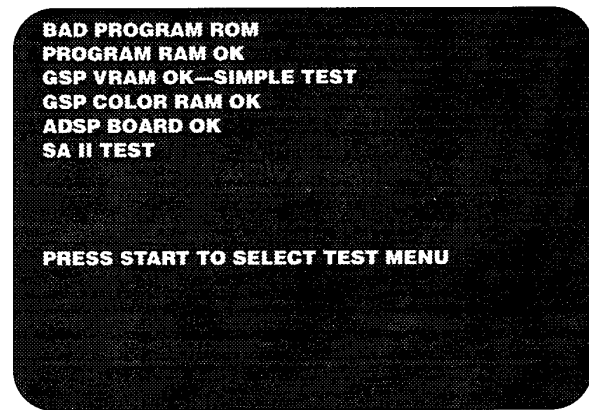

Figure 2-2 Microprocessor and Board Tests Screen

A brief description of each microprocessor and board test performed in the self-test is below.

PROGRAM ROM: Described above.

PROGRAM RAM: Described above.

GSP VRAM: Uses the Simple GSP VRAM Test. (Described in the section *Main Board GSP Tests*.)

GSP COLOR RAM: Uses the GSP Color RAM Test. (Described in the section *Main Board GSP Tests*.)

ADSP Board: Tests the ADSP board memory and the ADSP-2100. Most of the error messages are self-explanatory. (*Does Not Respond* generally indicates a missing board.)

SA II Test: Tests the program ROM and RAM on the sound PC board. If any are bad, the message *SA II Test Error* or *SA II Timeout Error* appears on the screen.

Test Menu Screens

After the microprocessor and board test is finished, or you bypass it, press *START* to see the test menu screens. Press *START* once to see the screen with the instructions for moving and choosing in the test menu, shown in Figure 2-3. Press *START* again to see the test menu.

To move down the menu, press the right trigger switch. To move up the menu, press the left trigger switch. You can choose the test menu item with the white letters by pressing *START*.

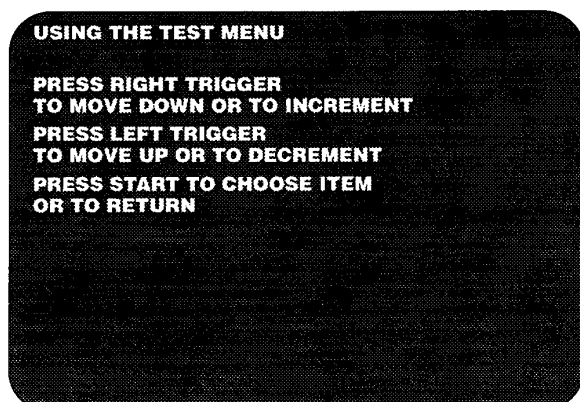

Figure 2-3 Instructions for Test Menu Screen

The test menu, shown in Figure 2-4, is the most important screen in the self-test. Use this screen to choose the other screens and tests in the self-test. If you choose any item on this test menu, a new screen on that subject appears. Table 2-4 lists all the screens that appear in the self-test.

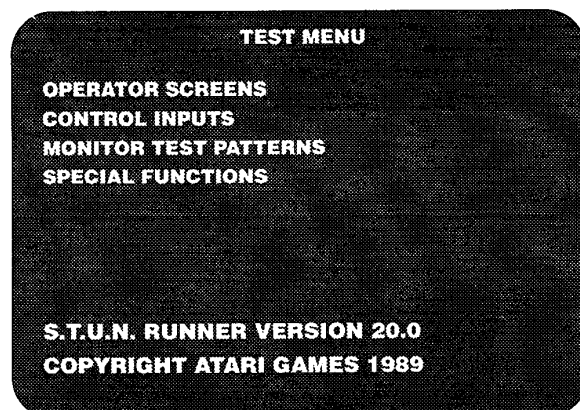

Figure 2-4 Test Menu Screen

Operator Screens

Choose the operator screens in the test menu by holding **START** while the words *Operator Screens* are in white. (For information about moving and choosing in the menu, see the section above.)

If you are in the operator screens and want to go to the attract mode, first press **START** to go through the remaining operator screens. When you return to the test menu, turn off the self-test switch.

Following are the screens in the operator screens sub-menu:

- Coin Options
- Game Options
- Game Statistics
- Game Histograms
- Error Count
- High Score Tables Reset Screen

Coin Options

The coin options appear in the first operator screen (see Figure 2-5). To move and choose in this screen, do the following:

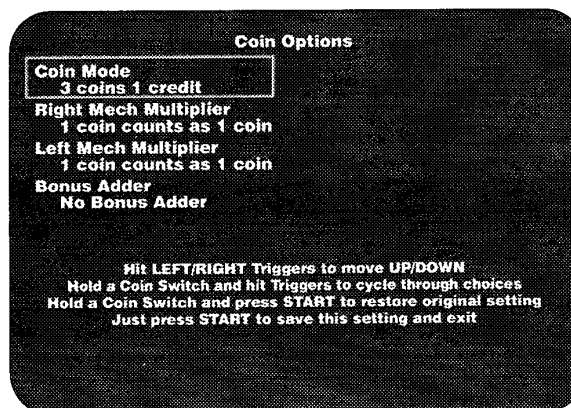

Figure 2-5 Coin Options Screen

- To move up or down the list, press the right or left triggers.
- To change a setting, press a trigger and either coin switch.
- To return to the setting originally on the screen, hold a coin switch and press **START** at the same time.
- To exit the screen, press the **START** button.

You can change an option when it is enclosed in a blue box. The default setting of each option is green. The other settings are blue when you select that option. The possible settings are shown in Table 2-2.

The coin options are explained below.

- *Coin Mode* is the number of coins required for one credit.
- *Right Mech Multiplier* is the number of coins each coin counts as in the right coin mechanism.
- *Left Mech Multiplier* is the number of coins each coin counts as in the left coin mechanism.
- *Bonus Adder* lets you choose bonus coins, no bonus, or free play.

Table 2-2 Coin Option Settings

Option	Available Settings
Coin Mode	1 coin/1 credit 2 coins/1 credit ♦ 3 coins/1 credit 4 coins/1 credit
Right Mech Multiplier	1 coin counts as 1 coin ♦ 1 coin counts as 4 coins 1 coin counts as 5 coins 1 coin counts as 6 coins
Left Mech Multiplier	1 coin counts as 1 coin ♦ 1 coin counts as 2 coins
Bonus Adder	No bonus adder ♦ 2 coins give 1 extra coin 4 coins give 1 extra coin 4 coins give 2 extra coins 5 coins give 1 extra coin 3 coins give 1 extra coin Free Play

♦ *Manufacturer's recommended settings*

Game Options

Use this screen to set the game difficulty and various other operator options explained below. The screen is shown in Figure 2-6, and a table of the options is shown in Table 2-3.

To move and choose in this screen, do the following:

- To move up or down the list, press the right or left trigger.
- To change a setting, hold down a coin switch and press either trigger.
- To return to the setting that was originally on the screen, press a coin switch and the START button at the same time.
- To exit the screen, press the START button.

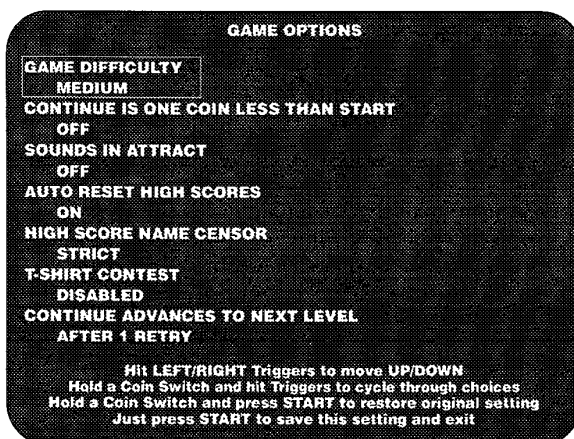

Figure 2-6 Game Options Screen

Table 2-3 Game Option Settings

Option	Available Settings	
Game Difficulty	Very Easy Easy Medium Easy Medium ♦	Medium Hard Hard Very Hard Nasty
Continue is One Coin Less Than Start (optional)	Off ♦	On
Sounds in Attract	Yes ♦	No
Auto Reset High Scores	Off	On ♦
High Score Name Censor	Strict	Easygoing ♦
T-Shirt Contest	Disabled	Enabled ♦
Continue Advances to Next Level	After 1 Retry ♦ After 2 Retries	Always Never

♦ *Manufacturer's recommended settings*

You can change an option when it is inside a blue box. The default setting of each option is green. The other settings are blue when the option is selected. (The other settings are white when the option is *not* selected.)

- *Game Difficulty* sets the game difficulty for the game. The settings are shown in Table 2-3.
- *Continue is One Coin Less Than Start* enables or disables the option that offers players an additional game for one coin. This option only appears if the coin mode option is set to 2, 3 or 4 coins/1 credit.
- *Sounds in Attract* enables or disables the game sounds during the attract mode demo sequence.
- *Auto Reset High Scores* enables or disables the automatic resetting of all high score tables. When enabled, if 2000 or more games have been played overall and 200 games have been played without *any* high score entry on any table, *all* high score tables are reset.
- *High Score Name Censor* controls a program to censor names entered on the high score table. The program deletes letters in possibly objectionable words in the high score table.
- *T-Shirt Contest* enables or disables the T-shirt contest option. You should always have this option disabled after the contest ends on April 1, 1990.
- *Continue Advances to Next Level*: When a player fails to complete a level (thus ending the game), he can be allowed to advance to the next level on a continuation.

Statistics

The statistics screen is shown in Figure 2-7. The statistics are collected from the last time the statistics screen was cleared. Write this information on the statistics

Table 2-4 Summary of All Screens Appearing in the Self-Test

Screen	Use
Automated Self-Test	
Program RAM and ROM	Tests the program RAM and ROM.
Automated Self-Test Results	Shows results of the program RAM and ROM, VRAM, color RAM, ADSP PCB, and sound PCB tests.
Test Menu Screens	
Instructions for Test Menu	Shows information about using the test menu.
Test Menu	Shows a list of available tests and information you can choose.
Operator Screens	
Coin Options	Sets the coin options.
Game Options	Sets the game options, controls the high score table and steering in the attract mode.
Statistics	Shows game statistics.
Histograms	Shows game histograms, and number of games by length of play (six total).
Error Count	Shows the error count from the PC boards. Used by the factory for debugging.
High Score Table	Shows main high score table and allows the manual resetting of <i>all</i> high score tables.
Control Inputs	
Check this screen <i>regularly</i> to make sure your controls are operating correctly.	
Monitor Test Patterns	
Use these screens to check the performance of your video display.	
Color Bars	Shows the video display colors.
Monitor Adjust	Used for the monitor setup.
Monitor Brightness	Shows the brightness adjustment.
Grey Scale	Shows the grey scale of the video display.
B/W Dots	Shows convergence and focus of the video display.
B/W Grid	Shows convergence and focus of the video display.
Diagonal Lines	Shows linearity of the video display.
Full Screen Grey	Shows the color purity of the video display.
Full Screen White	Shows the color purity of the video display.
Full Screen Red	Shows the color purity of the video display.
Full Screen Green	Shows the color purity of the video display.
Full Screen Blue	Shows the color purity of the video display.
Monitor High Voltage Test	Checks the regulation of the high voltage to the video display.
Scrolling Test	Checks the scrolling mechanism of the GSP microprocessor.
Special Functions	
Use this screen for tests of the controls, PCBs, and microprocessors.	
Main Board GSP Tests	Use this screen if you have a VRAM failure in the automated self-test.
VRAM Simple Test	Checks for bad VRAMs in the GSP microprocessor system.
VRAM Verify Test	Tests all the VRAM GSP memory.
VRAM Complete Test	Completely tests all VRAM.
Test VRAM for Display Errors	Tests for VRAM video display errors.
Color RAM	Tests the color RAM.
VRAM Shift Register Test	Checks the VRAM shift register.
Main Board ROM Checksums	Use this test if the program ROMs fail the automated self-test.
Main Board ZRAM Tests	Check the ZRAMs. Use this if all the controls are operating erratically or the statistics are not kept correctly.

Table 2-4 Summary of All Screens Appearing in the Self-Test, Continued

Screen	Use
ADSP Board Tests	
ADSP RAM .TESTED BY 68010.	Use this test if the ADSP board fails the automated self-test.
ADSP PROGRAM MEMORY TEST .2100.	The 2100 runs a standard, complete test on its own program memory.
ADSP DATA MEMORY TEST .2100.	The 2100 runs a standard, complete test on its own data memory.
2100 TEST	Tests the response of the 2100 integrated circuit on the ADSP PCB.
IRQ TEST	Tests if the ADSP system can generate IRQs.
ROM CHECKSUMS	Tests the graphics ROMs on the ADSP PCB.
ADSP SPECIAL FUNCTIONS	Performs hardware diagnosis and oscilloscope test loops for use by a repair technician.
Audio Board Tests	
Sound Board Self-Test	Use these tests if the SA II audio board fails the automated self-test.
Play Sounds	Tests the sound PCB and reports the results. Choose and hear game sounds.

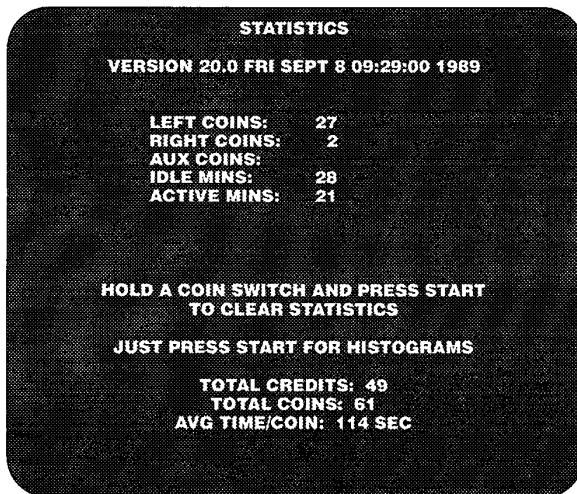
**Figure 2-7 Statistics Screen**

sheet in the back of this manual to help you maximize your profit.

To move to the next screen, just press **START**. To clear the statistics, hold a coin switch and press **START** at the same time.

The statistics that the game collects are explained below.

- *Left Coins* shows the number of coins counted in the left coin mechanism.

- *Right Coins* shows the number of coins counted in the right coin mechanism.
- *Aux Coins* is not used.
- *Idle Mins* shows the number of minutes the game has been idle.
- *Active Mins* shows the number of minutes the game has been played.
- *Total Credits* is calculated by multiplying the coins by the credit setting you chose in *Coin Mode*.

Histograms

Read the histogram screen frequently and record the numbers on the statistics sheet in the back of the manual. You should read and reset the screen frequently because if more than 256 games occur in any one time category, then the counts of all the time categories are divided by two, so the information remains proportionally accurate, but not numerically accurate.

If you read the screen infrequently, it is likely that you will not have a true numerical count of the number of sessions because of the way the histogram numbers are handled. The histograms screens appear in Figures 2-8 to 2-13.

To clear the histograms, hold a coin switch and press **START** at the same time. To move to the next screen, press **START**.

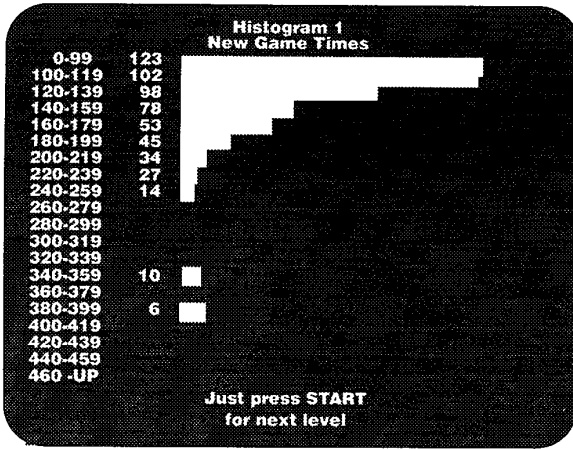

Figure 2-8 First Histogram Screen

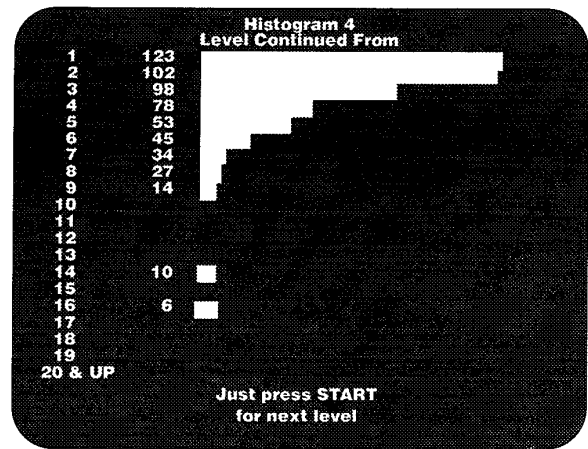

Figure 2-11 Fourth Histogram Screen

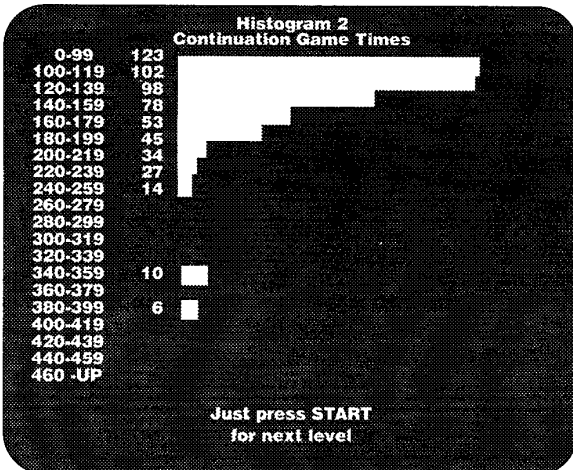

Figure 2-9 Second Histogram Screen

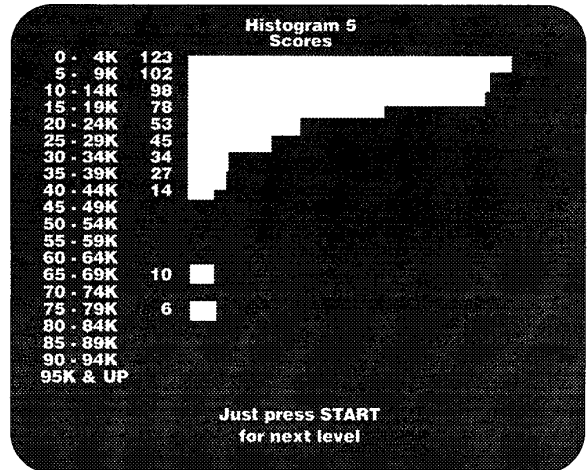

Figure 2-12 Fifth Histogram Screen

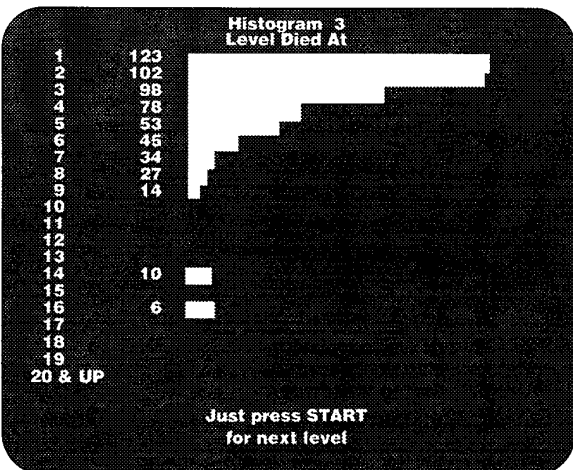

Figure 2-10 Third Histogram Screen

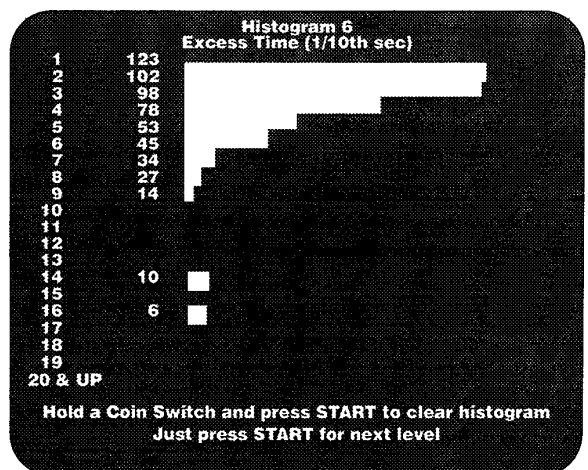

Figure 2-13 Sixth Histogram Screen

Error Count

This screen, shown in Figure 2-14, shows the error counts on the PC boards. If you call Atari Game Customer Service, the numbers on this screen may help Customer Service personnel troubleshoot your problem.

ERROR COUNTS	
WATCH DOG RESET	0
BUSS ERROR	0
ADDRESS ERROR	0
ILLEGAL INST ERROR	0
DIVIDE BY ZERO ERR	0
CHK INST ERROR	0
TRAP ERROR	0
PRIV VIOL ERROR	0
GSP HANDSHAKE ERROR	0
BAD POLY BUFF ERROR	0
MSP TIME OUT ERROR	0
ADSP TIME OUT ERROR	0
GSP TIME OUT ERROR	0
GENERIC ERROR	0
NMI ERROR	0
SPUR EXPTN ERROR	0
ILLEGAL ERROR CODE	0

Hold a Coin Switch and press START to clear error counts
Just press START for next menu

Figure 2-14 Error Counts Screen

Control Inputs Screen

Check this screen as part of your regular maintenance to be sure your controls are operating correctly. The *Control Inputs* screen is shown in Figure 2-15.

CONTROL INPUTS	
██████████	CONTROL LEFT/RIGHT 55
██████████	02
██████████	CONTROL UP/DOWN 80
██████████	02
██████████	02
██████████	02
██████████	02
██████████	02
LCOIN RCOIN LEFT TRIGGER RIGHT TRIGGER	

Figure 2-15 Control Inputs Screen

If you have a problem with a control, check Chapter 3 for troubleshooting and repair information about the control.

When the line is shortest, the input is 0 Volts. When it is longest, the input is 5 Volts. If the line length for the control does not change, you have a problem with the control. See Chapter 3.

Monitor Test Patterns

Use this item to see the thirteen screens for checking the video display, the color RAMs, the GSP, which controls the video RAMs (VRAMs), and the video output. To move through the screens, press the coin switches.

- *Color Bars* screen shows these colors from left to right: white, yellow, light blue, green, purple, red, blue, and grey. If the colors are incorrect, see your video display manual for adjustment procedures.
- *Monitor Adjust* is used to set up the monitor.
- *Monitor Brightness* checks the adjustment of the video display brightness.
- *Grey Scale* screen shows a white line on the left, and a grey scale showing black on the left.
- *B/W Dots* screen can be used to check convergence and focus.
- *B/W Grid* screen, shows a black background and a white grid pattern to check convergence. The grid lines should be straight within 3.0 mm. If you need to adjust the convergence, see the video display manual included with the game.
- *Diagonal Lines* screen can be used to check video display linearity.
- *Full Screen* colors test the color purity of the color RAMs and the display. The test displays a grey, white, red, green, and then blue screen. Each screen should be a rectangle of color, with no curving at the corners and no lines in the raster. If it is not, see your video display manual included with the game for adjustment procedures.
- *Monitor High Voltage Test* screens switch between a white screen and a grey screen. If the high voltage to the display is regulated properly, the sizes of the white and grey screens will differ by about 3/4 inch.
- *Scrolling Test* screen checks the scrolling mechanism in the GSP.

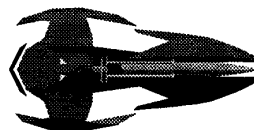

Special Functions Screens

Use the items on this screen, shown in Figure 2-16, if a system or board failed the program RAM and ROM test; if a board and microprocessor failed the automated self-test; if you have problems with the flight control or if the statistics are erratic. A short summary of when to use these items is provided in Table 2-5.

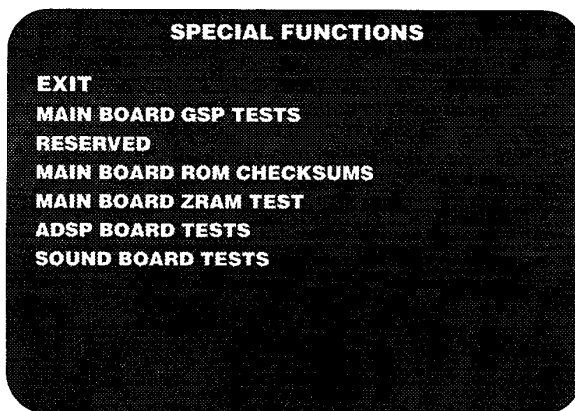

Figure 2-16 Special Functions Screen

The *Special Functions* items are explained below.

- *Exit* returns you to the test menu.
- *Main Board GSP Tests* should be used if you get the message *Bad GSP VRAM* or *Bad GSP Color RAM* in the automated self-test. This screen has six tests you can use.
- *Main Board ROM Checksums* should be used if you get the message *Bad Program ROM* in the automated self-test. This tests the program ROMs individually and shows the results on the screen.
- *Main Board ZRAM Test* should be used if your controls settings are changing or erratic. Also use these tests if you suspect the game is not keeping the statistics correctly.
- *ADSP Board Tests* should be used if you get any message other than *ADSP Board OK* for the ADSP board test in the automated self-test. This screen has five tests and an ADSP ROM checksum test. It also has a special functions menu for factory use only.
- *Sound Board Tests* should be used if you get the message *SAIL Test Error* in the automated self-test.

Main Board GSP Tests

If the automated self-test reports bad VRAMs, choose *Main Board GSP Tests* and the screen in Figure 2-17 appears.

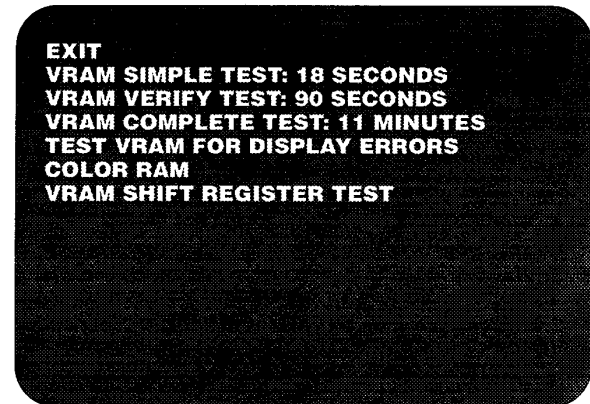

Figure 2-17 GSP Tests Screen

First run the VRAM simple test. It gives the location of the bad VRAMs. If the VRAMs pass this test, but you think the game has a bad VRAM, run the VRAM verify test.

- *VRAM Simple Test* is the same test that is run in the automated self-test. It is run by the 68010 through the GSP interface and detects open or shorted address or data lines or missing parts. The results are displayed on-screen with a picture showing the VRAM section of the main PC board. The good parts are shown in green and the bad parts are shown in red. If an entire section appears in red, the problem may be with a buffer associated with that section. The test takes about 15 seconds.
- *VRAM Verify Test* is a complete memory test run by the GSP. The results are reported on the screen as in the simple test. The test takes about 90 seconds to run.

Since the verify test is run by the GSP program in the VRAMs, a single bad VRAM can cause the GSP program to crash. When this happens, the 68010 microprocessor reports that all the VRAMs are bad, although probably only one VRAM is bad. You must run the VRAM complete test (described below) to find out which VRAM is bad.

If the VRAM verify test fails, but the VRAM simple test shows the VRAMs are good, you should run the VRAM complete test.

If the verify test runs and reports that the VRAMs are good, then the VRAMs should be good.

Table 2-5 When to Use the Special Function Items

Item	When to Use
Main Board GSP Tests	If you see the message <i>Bad GSP VRAM</i> or <i>Bad GSP Color RAM</i> in the automated self-test.
Main Board ROM Checksums	If you see the message <i>Bad Program ROM</i> in the automated self-test.
Main Board ZRAM Tests	If your control settings are changing even though you have used the <i>Set Controls</i> screen or if the statistics are not being kept correctly.
ADSP Board Tests	If you see any message other than <i>ADSP Board OK</i> for the ADSP PC board test in the automated self-test.
Sound Board Tests	If you see the message <i>SAll Test Error</i> in the automated self-test.

- *VRAM Complete Test* is a complete memory test run by the 68010 through the GSP interface. Because the 68010 runs the test, a single bad VRAM does not cause the test to report that all the VRAMs are bad (as it does the verify test).
Any VRAMs that are bad are shown on the screen at the end of the test. This test takes at least eleven minutes to run.
- *Test VRAM for Display Errors* checks for video display problems.
- *Color RAM* is the same test that is performed in the automated self-test. It tests the color RAM and reports the results.
- *VRAM Shift Register Test* checks the shift register part of the video RAMs.

Main Board ROM Checksums

This screen checks the main PC board program ROMs for errors. Use this test if you have a bad program ROM message in the automated self-test or you suspect program ROM failure. To exit this screen, press START.

When the checksum test is complete, the screen shows the list of ROM locations, the checksum, and what the checksum is expected to be (see Figure 2-18). Only the last two digits of the checksum are important.

Main Board ZRAM Test

This test checks the non-volatile RAM where the game statistics and control set-up values are kept. Check the ZRAMs if you think the statistics are incorrect.

If the game loses power or is reset while it is in this test, then the statistics will be lost. The statistics cannot be restored.

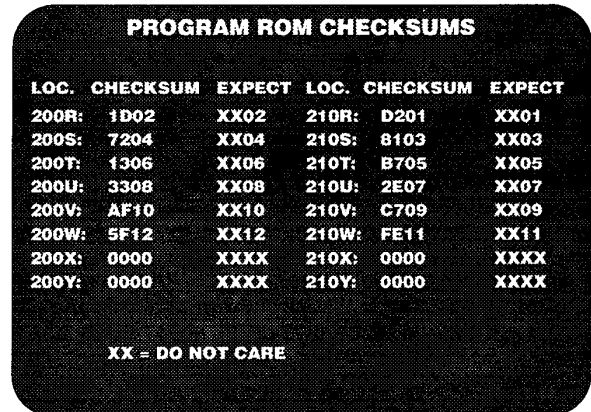

Figure 2-18 ROM Checksums Screen

ADSP Board Tests

Use this item if the ADSP PC board fails the microprocessor and board tests performed in the automated self-test.

When you select *ADSP Board Tests* from the test menu, the screen in Figure 2-19 appears. The items on the screen are explained below.

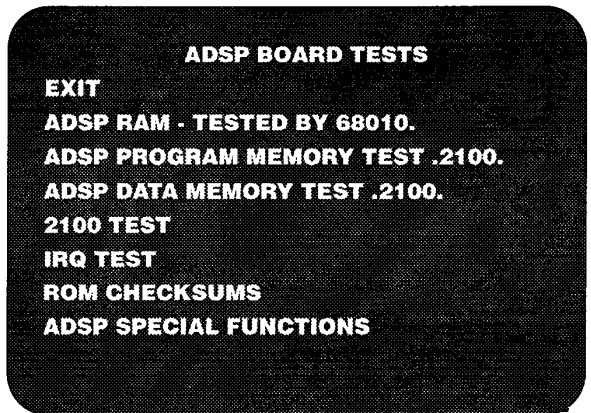

Figure 2-19 ADSP Board Tests Screen

- *Exit* returns to the test menu.
- *ADSP RAM Tested by 68010* tests the memory on the ADSP PC board. The 68010 on the main PCB tests the ADSP program memory, the ADSP data memory, and both ADSP output buffers. The memory tests are the standard, complete tests but are run at the 68010's bus speed, which is slower than that of the 2100.
- *ADSP Program Memory Test .2100.* is a standard, complete memory test run by the 2100 on its own program memory. Since the test program must reside in memory, a bad program RAM may prevent the test from running. However, because the program memory is divided into two banks, the test is divided into two parts.

The program to test the upper bank is run from the lower bank; the program to test the lower bank is run from the upper bank. Unfortunately, the 2100 always starts operating from a specific address in the lower bank. Therefore, the lower bank must be operating to the extent that it can execute a JUMP instruction to the upper bank.

These tests operate solely with program memory; they do not require that any data memory be operational.
- *ADSP Data Memory Test* is a standard, complete test run by the 2100. It operates solely with program memory and does not require that any data memory be functional.
- *2100 Test* checks the response of the 2100 integrated circuit on the ADSP PC board by copying data from one location to another using a 2100 program.
- *IRQ Test* checks if the ADSP can generate interrupts for the 68010.
- *ROM Checksums* tests the graphic ROMs on the ADSP PC board. When the checksum test is complete, a hexadecimal number follows each ROM as shown in Figure 2-20. The first two digits in each hexadecimal number can be any number, but the last two digits must be the ones shown in Figure 2-20. If the last two numbers are different, then the ROM is bad or it is not on the board.
- *ASDP Special Functions* performs hardware diagnosis for use by a repair technician.

Audio Board

Use these tests if the SA II Audio board failed the microprocessor and board tests in the automated self-test.

If the SA II Audio board failed the test, select this item from the test menu and a screen such as the one in Figure 2-21 appears. The tests are explained below.

ADSP ROM CHECKSUMS			
LOC.	CHKSUM	EXPECT	
ASDP 9K:	7F17	XX17	.2L.
ASDP 9/10K:	5518	XX18	.0L.
ASDP 10K:	8919	XX19	.1L.
ASDP 9H:	0E20	XX20	.2H.
ASDP 9/10H:	DF21	XX21	.0H.
ASDP 10H:	3022	XX22	.1H.

XX = DO NOT CARE

Figure 2-20 ADSP ROM Checksums Tests Screen

- *Exit* returns to the test menu.
- *SA Self-Test* checks the sound program ROM and RAM.
- *Play Sounds* takes you to the *Requesting Sound Screen*. Follow the instructions on the screen to hear the game sounds.

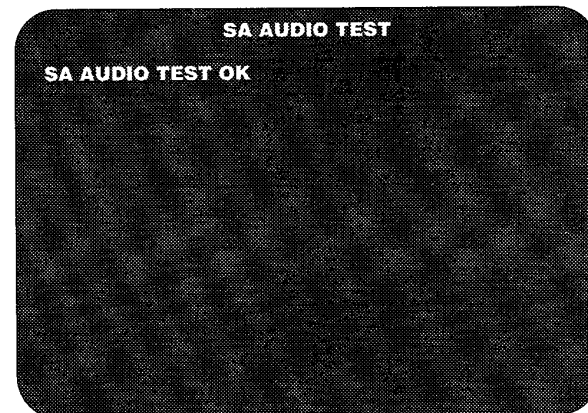

Figure 2-21 SA Audio Test Screen

LEDs on the Main PCB

The LEDs (light-emitting diodes) on the main PCB show you the status of signals on the main PCB. Using the LEDs, you can check signals from various circuits going to the 68010 processor. The state of the signals is shown by the LEDs which flash or stay lit.

Figure 2-22 shows the location of the LEDs on the main PCB. Table 2-6 shows the possible status of the LEDs, with an explanation of what they indicate.

Table 2-6 LED Status

LED	Indicates	Status
Run LED	State of 68010 HALT signal.	<i>On</i> when 68010 is running. <i>Off</i> when 68010 processor is not running. <i>Flashing at 2 Hz</i> if the 68010 cannot run. (The watch-dog and clock must be running.) (The Run LED is <i>on</i> in game mode.)
DTACK LED	State of 68010 DTACK (data acknowledge) signal.	<i>On</i> when the 68010 processor is running and the timing circuit is probably operating. <i>Flashes at 2 Hz</i> when the 68010 processor cannot run. (The watchdog and processor clock must be running.) (The DTACK LED is <i>on</i> in game mode.)
Clock LED	State of the 68010 processor clock signal.	<i>On</i> when the game board is on. <i>Off</i> if the processor clock signal is stuck high or low.
IRQS LED	State of all 68010 interrupts.	<i>On</i> in the game mode. <i>Off</i> in hardware diagnostic mode and the early part of self-test. <i>Off</i> if no interrupts are occurring or any interrupt signal is stuck low.

DIP Switches

If you try to enter the self-test, but nothing appears on the screen, use the DIP switch tests. Use the information from these diagnostic tests to help you find the problem.

Before you begin with these following tests, be sure that the problem is in the game hardware, not in the video display. If you have a completely dark screen, check the following:

- Do you have power to the video display?
- Are the video display's filaments lit?
- Do you have high voltage to the video display?

If the answer to any of these questions is no, then you have a problem in the video display. Check the video display service manual included with your game for the suggested procedure.

If you are sure that the problem is not with the video display, then try the DIP switch diagnostics shown in Table 2-7, at the end of this chapter. These tests isolate various ICs and systems for troubleshooting. The results of the tests are indicated by the main PC board LEDs or on the video display screen.

To set the DIP switches for the tests:

1. Put a jumper across the DIAGN test points, shown in Figure 2-22.
2. Select the diagnostic test you want to use with the DIP switch settings.
3. Turn on the self-test switch.

4. Put a jumper momentarily across the RESET test points, shown in Figure 2-22.

To change to another DIP switch test:

1. Change the DIP switch settings.
2. Put a jumper momentarily across the RESET test points.

To end the DIP switch testing:

1. Take the jumper off the DIAGN test points.
2. Put a jumper momentarily across the RESET test points.

The DIP switch settings are *on* in the top position when the main PCB board is in the game.

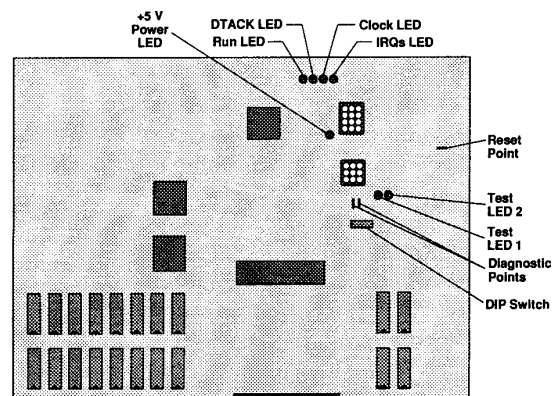

Figure 2-22 DIP Switch and LED Locations on the Main PCB

Table 2-7 Using the DIP Switches

Type of Test	Purpose and Results	DIP Switch Settings							
		1	2	3	4	5	6	7	8
Watchdog, Test Program ROMs, Test Menu RAMs, and LED Tests									
Uncleared Watchdog	Puts the 68010 in a loop. Does <i>not</i> clear the watchdog counter. The program RAM does not need to work. If the watchdog is working, the run LED, DTACK LED, and IRQs LED flash at 2 Hz and the clock LED is on.	X	X	0	0	0	0	0	0
Cleared Watchdog	Puts the 68010 in a loop. Clears the watchdog counter. The program RAM does not need to work. If the watchdog is working, the run LED, clock LED, DTACK LED and IRQs LED are on.	X	X	0	0	0	0	0	1
Test LEDs	Tests the test LEDs. The program RAM does not need to work. If the test LEDs are working, they flash at 2 Hz.	X	X	0	0	0	0	1	1
Test Program ROM 0	Tests ROM 0 H and 0 L, which hold the test program. (This test takes about 5 seconds.) LED 1 and LED 2 flash together if both ROMs are good. If ROM 0 L is bad, LED 1 does not flash. If ROM 0 H is bad, LED 2 does not flash.	X	X	0	0	0	1	1	1
Test Menu RAM 0	Tests RAM 0 H and 0 L, which run the test menu. (This test takes about 5 seconds.) LED 1 and LED 2 flash together if both RAMs are good. If RAM 0 L is bad, LED 1 does not flash. If RAM 0 H is bad, LED 2 does not flash.	X	X	0	0	1	1	1	1
GSP Tests									
GSP Communications	Tests if the 68010 can communicate with the GSP, which produces the video. If the GSP responds, the LEDs flash together. If the GSP does <i>not</i> respond, LED 1 and 2 flash alternately.	X	X	0	1	1	1	1	1
Red Screen	Produces a red screen from the color RAM, regardless of GSP VRAM input. Use this to check the red video outputs.	X	X	0	1	1	1	1	0
Green Screen	Produces a green screen from the color RAM, regardless of GSP VRAM input. Use this to check the green video outputs.	X	X	0	1	1	1	0	0
Blue Screen	Produces a blue screen from the color RAM, regardless of GSP VRAM input. Use this to check the blue video outputs.	X	X	0	1	1	0	0	0
GSP Memory Fill	Does a very slow GSP memory fill so you can test the pixel scanner.	X	X	0	1	0	0	0	0
GSP VRAM Verify	Performs the GSP VRAM verify test. (This test is also in the self-test.)	X	X	1	0	0	0	0	0
ROM and RAM Tests									
ROM Test Loop	The results are displayed on the screen.	X	X	1	0	0	0	0	1
RAM Test Loop	The results are displayed on the screen.	X	X	1	0	0	0	1	1
Bus Error Test									
BERR	The DTACK timer times out and generates a bus error (BERR) signal. The results are displayed on the screen. <i>The DUART must be unplugged to perform this test.</i>	X	X	1	1	1	1	0	0
<i>1=On; 0=Off; X=Doesn't Matter.</i>									

MAINTENANCE & TROUBLESHOOTING

Chapter 3



This chapter includes maintenance, repair, and troubleshooting information for your S.T.U.N. Runner game.

In the game, the hardware and software are closely related. If you are having problems with a mechanical assembly, always keep in mind that your electrical connections may not be good or you may have an electronic problem. To determine what kind of problem you have, always use the self-test screens as recommended for each part.

The first part of the chapter includes a schedule for

game maintenance and inspection, a table with general troubleshooting information, and a table of the voltage levels and

test points on the PCBs. The rest of the chapter is arranged in alphabetical order by the name of the part or control. Under each part are maintenance procedures, troubleshooting tables and flowcharts, and repair procedures for the part.

If a part is mentioned, but not illustrated, refer to Chapter 4, *Illustrated Parts Lists*, for information.

Table 3-1 Maintenance and Inspection Items

Part	When to Check	What to Check and Maintain
All Controls	Every month	Use the <i>Control Inputs</i> screen to check the inputs from the controls to the main PCB.
Coin Mechanism	Every 6 months	Clean.
Interior Components	Every 3 months	Clean.

Table 3-2 Voltage Inputs and Test Points on the Game PCBs

PCB	Voltage	Test Points	Source and Purpose
Main	+5±0.1 VDC	+5V2	+5 V Switching Power Supply
ADSP	+5 VDC	+5V1 or +5V2	Regulated and supplied from the Main PCB through the interface cable.

Maintaining and Inspecting

Preventive maintenance includes inspecting, cleaning, lubricating, and tightening hardware. Perform the preventive maintenance regularly so you can keep the game in top condition, avoid problems, and maximize your earnings. Preventive maintenance tasks and intervals are shown in Table 3-1.

For the best performance from your S.T.U.N. Runner game, maintain your game according to the times shown in Table 3-1. Instructions for performing these tasks is explained in the section about that control in this chapter. You may want to perform these tasks more often if the game is heavily used.

Table 3-2 shows the correct voltage levels to various PC boards and the test points for those voltage levels. Low voltages to PC boards may cause problems with the controls, with the video display, or in game play.

Coin Mechanism

The coin mechanism should be cleaned every three months.

Maintaining the Coin Mechanism

1. Turn off the power to the game. Open the upper coin door.
2. Open the gate on the door covering the magnet. Use the blade of a screwdriver to scrape away any metal filings collected on the magnet.
3. For a thorough cleaning, wash the coin mechanism in hot soapy water. Use a toothbrush to remove any stubborn build-up of residue in the coin path.
4. Dry the coin mechanism with compressed air.
5. If you do not want to use water, brush the loose dust off with a soft brush and scrub the residue in the coin path with a toothbrush. Blow all the loose dust and dirt out with compressed air.

NOTE

Never lubricate the coin mechanism with oil or grease.

Interior Components

All the components in the interior of the game should be cleaned every three months. This includes the PCBs, the power supply and the video display.

Cleaning the Interior Components

Perform the following procedure to clean the components inside the cabinet.

1. Open the rear service and top service doors.

WARNING

Turn off the AC power, but do not unplug the power cord before cleaning inside the cabinet. The power cord provides a ground path for static voltage that can be present on the cleaning tools.

2. Use a vacuum cleaner with a soft long-bristled brush attachment or use a soft-bristled paint brush to remove loose dirt and dust from the inside of the cabinet. Be sure to clean the power supply, PCB assemblies, and video display thoroughly.

CAUTION

Be extremely careful when cleaning the electrical components inside the cabinet. Do not touch the electrical components with any solid object other than the soft bristles of the vacuum attachment or paint brush.

Video Display

If you have problems with the video display, check Table 3-3, *Troubleshooting the Video Display*, before you remove the display.

Adjusting the Video Display

To make adjustments to the video display, open the service door on the cabinet.

Removing the Video Display

Perform the following procedure to remove the video display. (See Figure 3-1.)

1. Turn the game power off and wait two minutes. Leave the power cord plugged in.
2. While you wait, unlock the top service door on the top of the cabinet.
3. Remove the six screws that attach the shield frame and remove the frame, shield, and bezel.

WARNING
High Voltage

The video display contains lethal high voltages. To avoid injury, do not service this display until you observe all precautions necessary for working on high-voltage equipment.

X-Radiation

The video display is designed to minimize X-radiation. However, to avoid possible exposure to soft X-radiation, never modify the high-voltage circuitry.

Implosion Hazard

The cathode-ray tube may implode if struck or dropped. The shattered glass from the tube may cause injury up to six feet away. Use care when handling the display.

4. Remove the four nuts and washers that service the monitor.
5. Discharge the high voltage from the cathode-ray tube (CRT). The display assembly contains a circuit for discharging the high voltage to ground when power is removed. However, to make certain, always discharge the display as follows:
 - a. Attach one end of a solid 18-gauge wire to a well-insulated screwdriver or wooden handle.
 - b. Attach the other end of the wire to an earth ground.
 - c. Quickly touch the blade end of the screwdriver to the CRT anode by sliding it under the anode cap.
 - d. Wait two minutes and repeat part c.
6. Disconnect the harness connectors from the video display.
7. Pull the video display assembly out of the cabinet. Be extremely careful.

WARNING

When you take the video display out of the cabinet, do not drop it! The display is heavy. Be careful!

Wear gloves to protect your hands from the sheet-metal edges.



Table 3-3 Troubleshooting the Video Display

Problem	Solution
Any problem.	Determine if the problem is with the display or the game hardware by performing the self-test. If you cannot perform the self-test, use the DIP switch diagnostics to narrow down the source of the problem.
Convergence, purity, or color problems.	Check the voltage level to the video display PCB. Check the video display settings with the <i>Monitor Test</i> screens in the self-test.

Replacing the Video Display

Perform the following procedure to replace the video display in the cabinet. (See Figure 3-1.)

1. Carefully lift the video display into the cabinet.
2. Install the nuts that hold the video display assembly.
3. Connect the power and signal harnesses to the video display.

NOTE

When you replace the cathode-ray tube and yoke together, adjust the brightness, size, and centering as described in the video display service manual.

Check the purity and convergence according to the service manual instructions, but adjust both only if required.

4. Install the video display shield and bezel. Replace the display frame.
5. Lock the top service door on the cabinet.

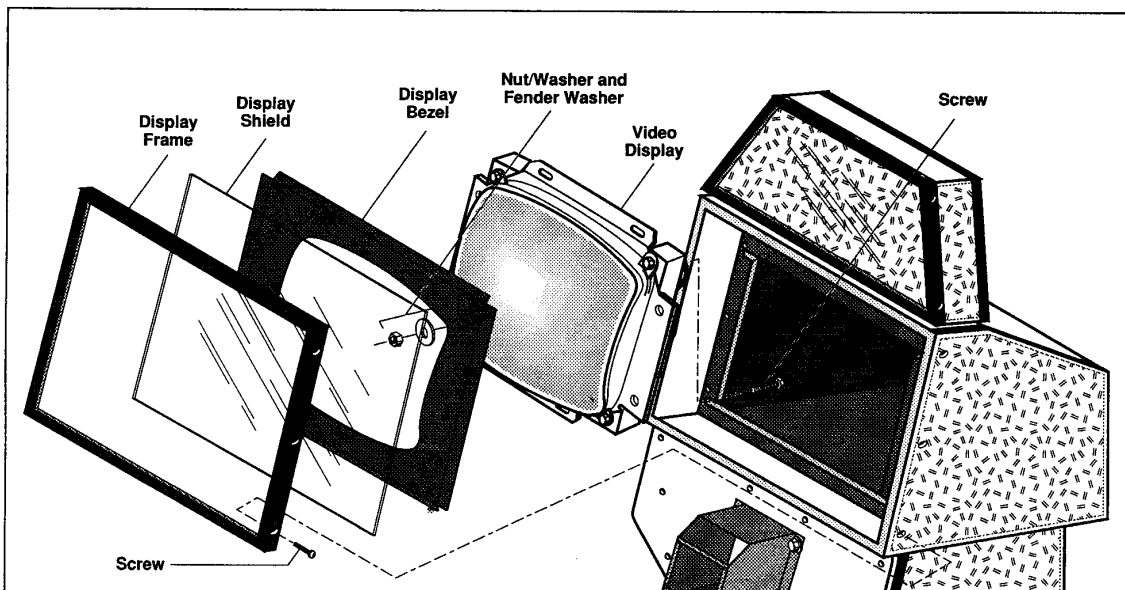

Figure 3-1 Removing the Video Display

Flight Control Maintenance

Routine preventive maintenance of the flight control involves lubricating the moving parts and checking the mounting screws and nuts for proper tightness approximately every four months. The flight control consists of a handle assembly and a flight control assembly. The handle assembly controls the vertical motion, and the flight control assembly controls the horizontal motion of the display. Routine maintenance can be performed without removing the flight control assembly from the game.

Refer to Figures 3-2 and 3-3 for the locations of the parts mentioned in the following procedures.

Routine Maintenance

Routine preventive maintenance on the flight control involves lubricating the moving parts and checking the mounting screws and nuts for proper tightness approximately every four months.

Lubrication. Lubricate the flight control assembly periodically, as follows (see Figures 3-2 and 3-3):

NOTE

The handle assembly cover is attached with tamper-proof socket screws. A special 1/8-inch hex-key tool is supplied with each game (Atari part no. 178126-004).

1. Use the special 1/8-inch hex-key tool to remove the screws from the handle assembly cover.
2. Lift off the handle assembly cover and lubricate the following parts inside the flight controls (refer to Figures 3-2 and 3-3 for the position of the lubrication points):
 - Apply two drops of light machine oil lubricant (Atari part no. 107013-001) to the insides of the four shaft bearings.
 - Apply a small amount of WD-40 or a light machine oil to the potentiometer shafts as needed to prevent squeaking.

Screw and Nut Tightness. Use the appropriate hex-head and combination wrenches to check the hex-head cap screws and mounting nuts for tightness. Refer to Figures 3-2 and 3-3 for an illustration of the cap screw and mounting nut locations.

Removing the Flight Control Assembly

NOTE

Certain corrective maintenance procedures can be done with the flight control attached to the cabinet. However, for convenience and to avoid damaging the cabinet, we recommend that you remove the flight control from the cabinet before performing any maintenance.

Perform the following procedure to remove the flight control assembly from the control panel:

1. Use a 5/32-inch hex key to remove the four flat-head screws that mount the flight control to the cabinet.
2. Carefully guide the flight control through the hole in the control panel.

Disassembling the Handle Assembly

Perform the following procedure to disassemble the handle assembly.

NOTE

Removing the handle assembly from the flight control assembly is not necessary to perform the procedure below. However, if you wish to do so, refer to Disassembling the Flight Control Assembly in this chapter for how to separate the two assemblies.

1. Use the special 1/8-inch hex-key tool to remove the four tamper-proof cap screws from the handle assembly cover.
2. Remove the handles and handle adapters.
3. Gently pull the harness wires out of the hollow shaft.
4. Use a 9/64-inch hex driver to remove the cap screw and washer that hold the spring handle pin to the handle assembly shaft.
5. Slide the spring-handle pin out of the shaft.
6. Use a 7/64-inch hex driver to loosen the cap screw that holds the large (60-tooth) spur gear to the shaft.
7. Slide the large (60-tooth) spur gear down the shaft to expose the shaft retainer on the right side.

WARNING

Shield your face and eyes when prying out the retainers because they can fly loose at a high velocity. Cover the retainers with a rag or any material that will trap the retainer.

8. Use a right-angle slotted screwdriver, or equivalent, to pry the retainer from the shaft.
 9. Repeat steps 7 and 8 to remove the retainer on the opposite side.
 10. Gently slide the shaft from the housing. Be careful not to lose the torsion springs.
 11. Use a 7/64-inch hex driver to loosen the cap screw that holds the small (14-tooth) spur gear to the potentiometer shaft.
 12. Use a 1/2-inch combination wrench to remove the nut and washer that hold the potentiometer to the mounting bracket.
 13. Slide the potentiometer from the bracket. Be careful not to lose the small spur gear, nut, and washer.
 14. Use a 5/32-inch hex-head wrench and 3/8-inch combination wrench to remove the two bumpers from the frame.
 15. Reassemble the handle assembly as described in the following procedure.
- ## Reassembling the Handle Assembly
- Perform the following steps to reassemble the handle assembly (see Figure 3-2):
1. Use a 5/32-inch hex-driver and 3/8-inch combination wrench to install the two bumpers on the frame.
 2. Insert the large (60-tooth) spur gear with the collar facing away from the bearing. Hold the gear in line with the bearing hole. (The gear fits through the slot on the right front of the frame.)
 3. Slide the shaft through the right-hand bearing and the spur gear. Do not insert the shaft past the outside edge of the spur-gear collar.
 4. Apply a heavy film of Nyogel 779 lubricant (Atari part no. 178027-001) to the inside of the springs.
 5. Hook the straight end of the first torsion spring through the hole closest to the right side of the frame.
 6. Hold the first torsion spring in line with the shaft so that the looped end of the spring is facing away from the spur gear.
 7. Slide the shaft just through the first torsion spring.
 8. Hook the straight end of the second torsion spring in line with the shaft so that the looped end of the spring is facing the first torsion spring.
 9. Hold the second torsion spring in line with the shaft so that the looped end of the spring is facing the first torsion spring.
 10. Slide the shaft through the second torsion spring and the left-hand bearing.
 11. Position the shaft so that the retainer grooves are just inside the bearings.
 12. Install the two retainers in the shaft grooves.
 13. Turn the shaft so that the two large holes and the smaller centered hole are facing upward.
 14. Locate the hole in the spring-handle pin. Insert the end of the spring-handle pin that is closest to the hole through the slot in the frame and through the hole in the shaft. Make sure that both torsion spring looped ends are wrapped over the spring-handle pin.
 15. Position the spring-handle pin so that the hole in the pin is aligned with the hole in the shaft.
 16. Use a 9/64-inch hex driver to tighten the cap screw and washer that secure the pin to the shaft.
 17. Align the cap screw in the spur-gear collar with the threaded hole in the shaft, and use a 7/64-inch hex driver to tighten the cap screw.
 18. Insert the potentiometer shaft through the hole in the mounting bracket. Place the washer, nut, and small (14-tooth) spur gear (with the collar facing inward) onto the shaft before fully inserting the shaft through the bracket.
 19. Align the potentiometer so that the tab key is inserted into the keying slot.
 20. Use a 1/2-inch combination wrench to slightly tighten the nut on the potentiometer shaft.
 21. Turn the potentiometer shaft so that the flat side faces the center wire terminal.
 22. Align the cap screw on the small (14-tooth) spur gear with the flat side of the shaft. Use a 7/64-inch hex driver to tighten the cap screw.
 23. Slide the potentiometer forward so that the teeth on the two spur gears are tightly meshed; then pull the potentiometer and small (14-tooth) spur gear away from the large spur gear by about 1/64-inch.
 24. Use a 1/2-inch combination wrench to tighten the potentiometer to the mounting bracket.
 25. Perform the procedure for installing the harness assembly provided later in this chapter.
 26. Install the handle adapters. Do not install the handle covers until the harness is installed and the proper wires are soldered to the trigger switch.
 27. Check the vertical potentiometer alignment.

28. Install the handle assembly cover and use the special 1/8-inch hex tool to tighten the four tamper-proof socket screws that secure the cover to the handle assembly.

Disassembling the Flight Control Assembly

Perform the following steps to disassemble the flight control assembly (see Figure 3-3):

1. Unsolder the three harness wires from the vertical potentiometer, handle and trigger microswitch.
2. Use a 5/32-inch hex driver (or ball-end driver) to remove the three cap screws that hold the flight control assembly shaft to the handle assembly frame.
3. Gently pull the two assemblies apart. Make sure the harness wires are free to slide out of the handle assembly shaft.
4. Use a 5/16-inch wrench to remove the anchor nut on the end of the anchor pin. (The anchor nut faces the open end of the frame.)
5. Slide the anchor pin out of the shaft.
6. Grasp the large (60-tooth) spur gear and slide the shaft from the frame. The bearing spacer, torsion springs, and large flat washer will fall free.
7. Use a 7/64-inch hex driver to remove the cap screw holding the large spur gear to the flight control shaft and a 5/64-inch hex driver to remove the set screw that holds the small spur gear to the potentiometer shaft.
8. Use a 1/2-inch combination wrench to remove the nut and washer that hold the potentiometer to the shaft.
9. Unsolder the three harness wires from the potentiometer terminals.

WARNING

Shield your face and eyes when prying out the retainer because it can fly loose at a high speed. Cover the retainer with a rag or any material that will trap the retainer.

10. Use a slotted screwdriver, or equivalent, to remove the retainer from the shaft.
11. Use a 5/32-inch hex driver and 3/8-inch combination wrench to remove the two bumpers from the frame.
12. Reassemble the flight control assembly as described in the following procedure.

Reassembling the Flight Control Assembly

Perform the following procedure to reassemble the flight control assembly (see Figure 3-3):

1. Use a 5/32-inch hex driver and 3/8-inch combination wrench to install the two bumpers onto the frame.
2. Snap the retainer into its groove in the shaft and slide the large flat washer down the long end of the shaft and against the retainer.
3. Apply a heavy film of Nyogel 779 lubricant (Atari part no. 178027-001) to the inside of the springs.
4. Hook the straight end of the first torsion spring through the hole closest to the rear of the frame. Slide the shaft through the outside bearing and the first torsion spring.
5. Hook the second torsion spring through the hole on the opposite side and closest to the front of the frame. Slide the shaft through the second spring and the opposite bearing.
6. Turn the shaft so that the threaded hole at the retainer end of the shaft faces up toward the open side of the frame. The hole through the center of the shaft will then be perpendicular to the open side of the frame.
7. Use a 5/16-inch combination wrench to install the anchor pin and nut through the hole in the center of the shaft. Make sure the torsion spring looped ends are wrapped under the anchor pin and nut.
8. Slide the large (60-tooth) spur gear onto the shaft with the collar facing outward.
9. Align the cap screw in the spur gear collar with the threaded hole in the shaft and use a 7/64-inch hex driver to tighten the cap screw.
10. Insert the potentiometer shaft through the hole in the frame and align the potentiometer so that the tab key is inserted into the keying slot.
11. Install the washer and nut on the potentiometer shaft but do not tighten.
12. Turn the potentiometer shaft so that the flat side faces the center wire terminal.
13. Align the cap screw on the small (28-tooth) spur gear with the flat side of the shaft and slide the small spur gear (with the collar facing inward) onto the potentiometer shaft.
14. Position the spur gear so that its teeth mesh with those on the large spur gear and use a 5/64-inch hex driver to tighten the set screw.
15. Slide the potentiometer forward so that the teeth on the two spur gears are tightly meshed; then slide the potentiometer and small spur gear away from the large spur gear by about 1/64-inch.

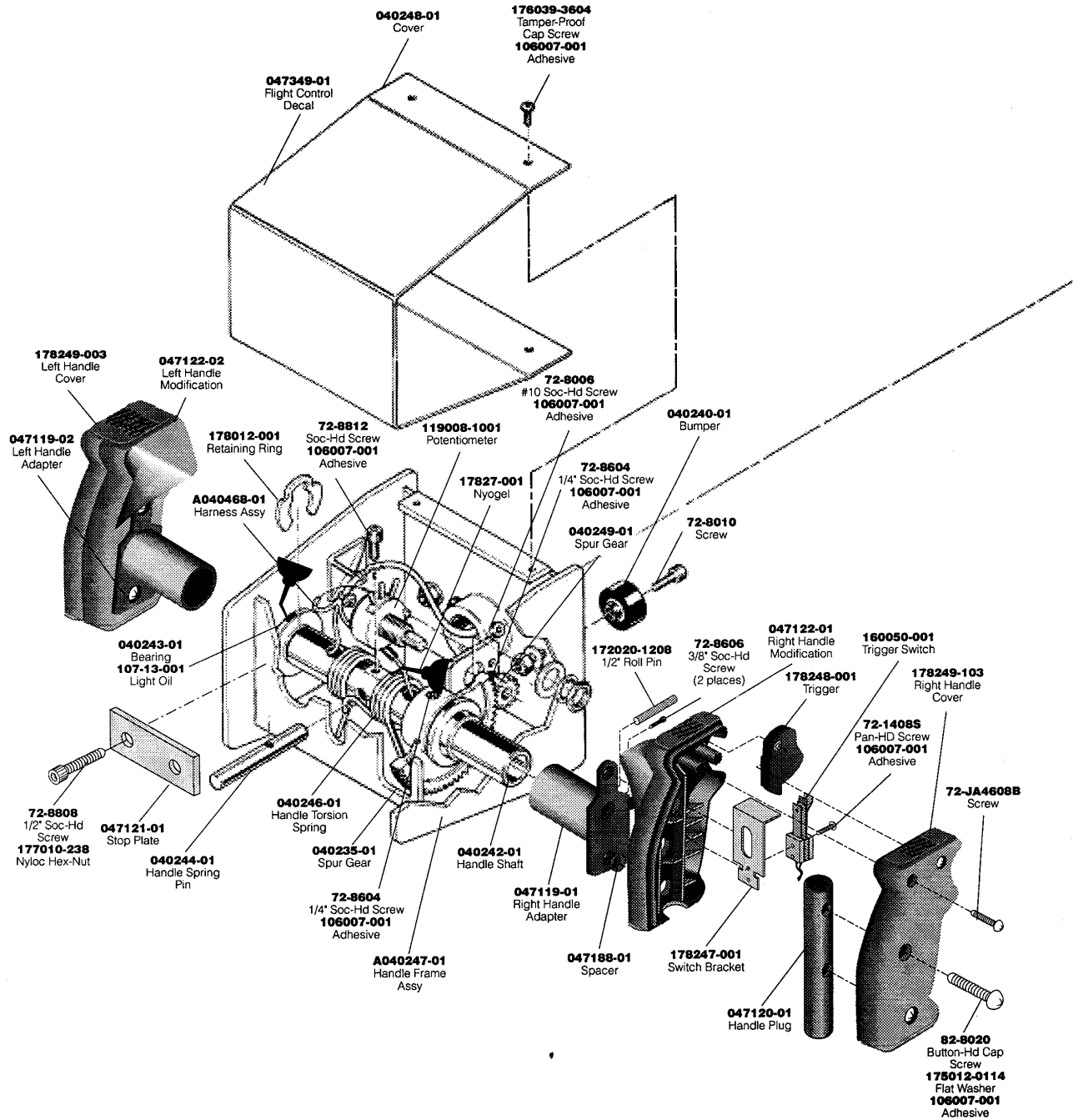

Figure 3-2 Flight Control Assembly

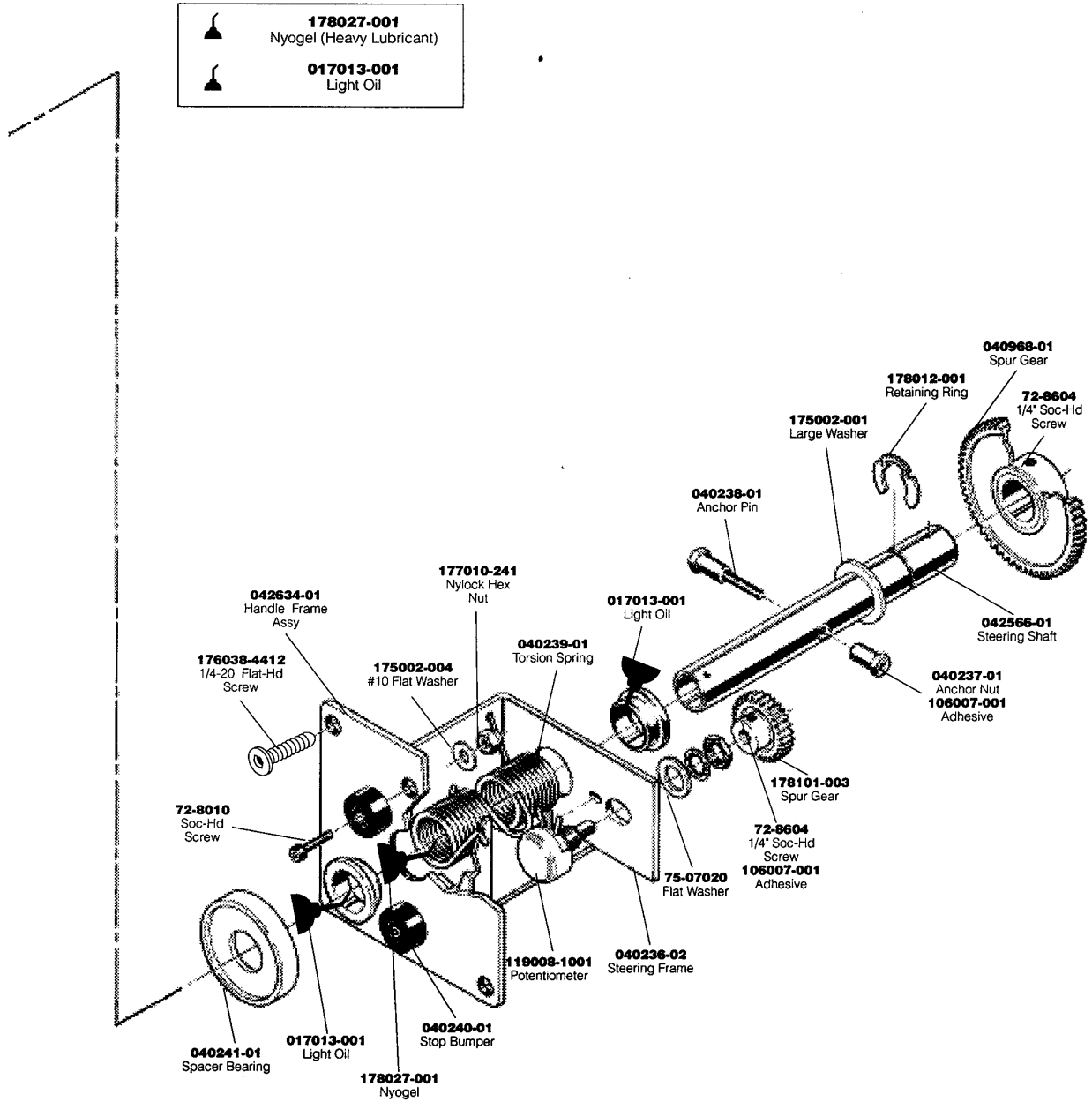

Figure 3-2 Flight Control Assembly, Continued

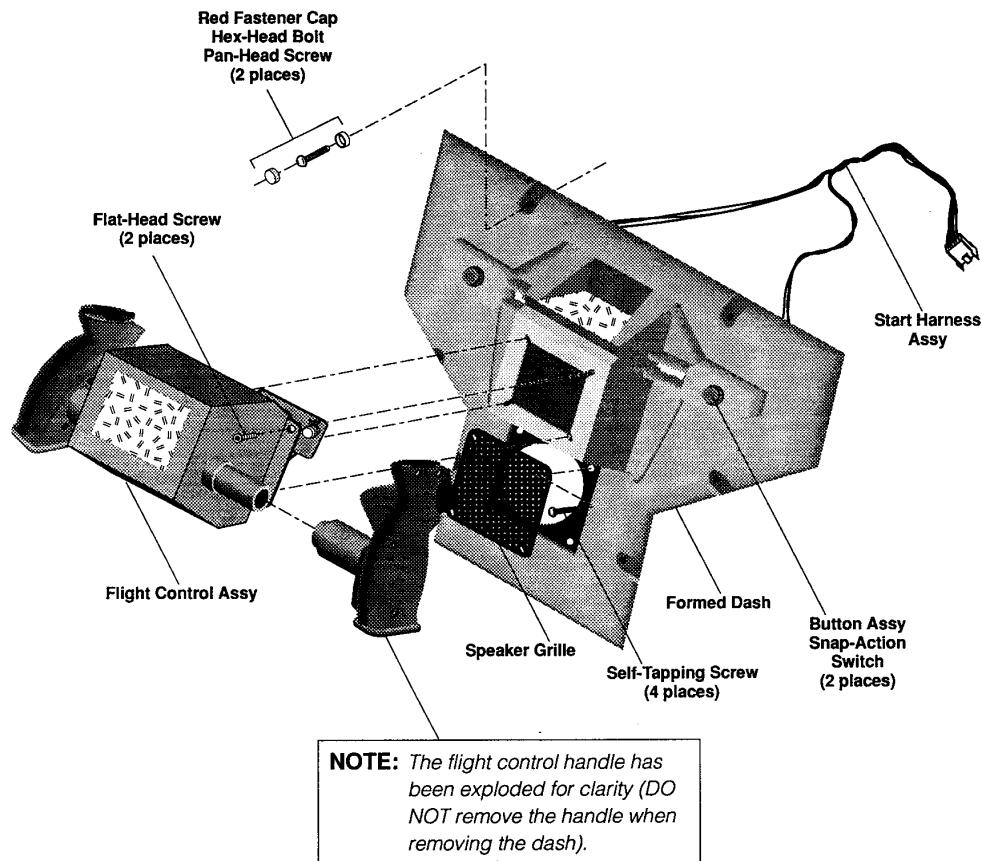

Figure 3-3 Flight Control Removal

16. Use a 1/2-inch combination wrench to tighten the potentiometer to the frame.
17. Slide the bearing spacer over the shaft at the end opposite the spur gears.
18. If necessary, lubricate the flight control assembly as previously described.

NOTE

The remaining steps describe the procedure for attaching the flight control assembly to the handle assembly.

19. Insert the flight control assembly shaft into the collar on the handle assembly frame.
20. Align the three holes in the flight control assembly shaft with the three holes in the handle assembly collar.
21. Use a 5/32-inch hex driver (or ball-end driver) to tighten the three cap screws.

22. Install the harness assembly as described in the following procedure.
23. Check the horizontal potentiometer alignment.

Installing the Harness Assembly

Perform the following procedure to install the harness assembly into the flight control (see Figures 3-2 and 3-3):

1. Guide the harness wires into the spur gear end of the hollow flight control assembly shaft.
2. Route and solder the wires to the potentiometers and switches. Note that the wire bundle that goes to the right handle is identified with a labeled sleeve (R).
3. Install the wire ties and the ground clip.

ILLUSTRATED PARTS LISTS

Chapter 4



This chapter provides information you need to order parts for your game. Common hardware parts, such as screws, nuts, washers, and so on usually are not listed in the parts lists.

The parts lists (except for the PCB parts lists) are arranged alphanumerically by Atari part number. All A-prefix numbers, which are assemblies, come first. Next are part numbers with six numbers followed by a hyphen (000598- through 201000-). Ending the list are part numbers with a two-number designation followed by a hyphen (00- through 99-).

by part number.

When you order parts, give the part number, part name, the number of this manual, and the serial number of your game. With this information, we can fill your order rapidly and correctly. We hope this will create less downtime and more profit from your games.

Atari Games Customer Service phone numbers are listed on the inside front cover of this manual.

The PCB parts lists are arranged in alphabetical order by component. Within each section the parts are arranged numerically

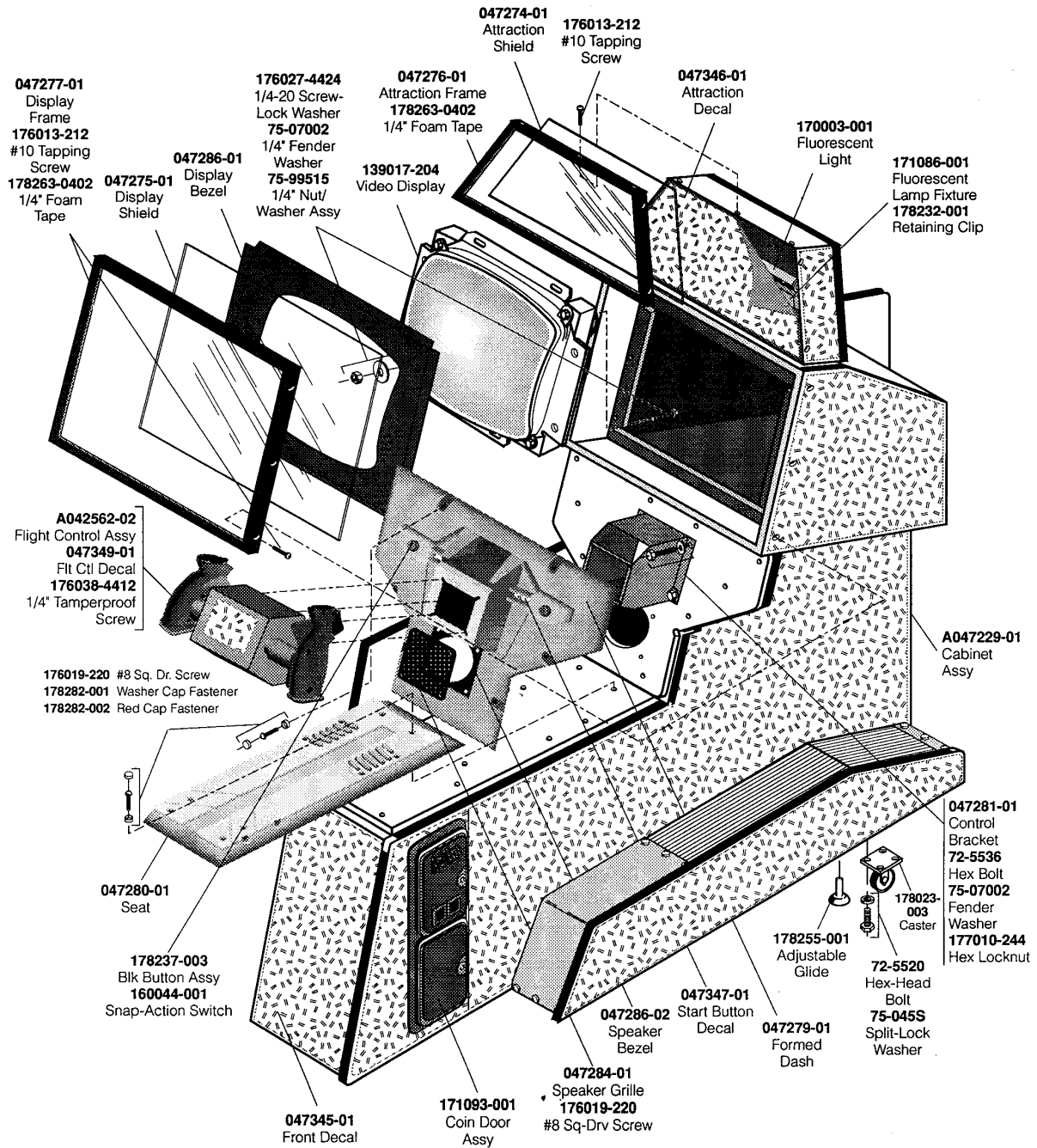
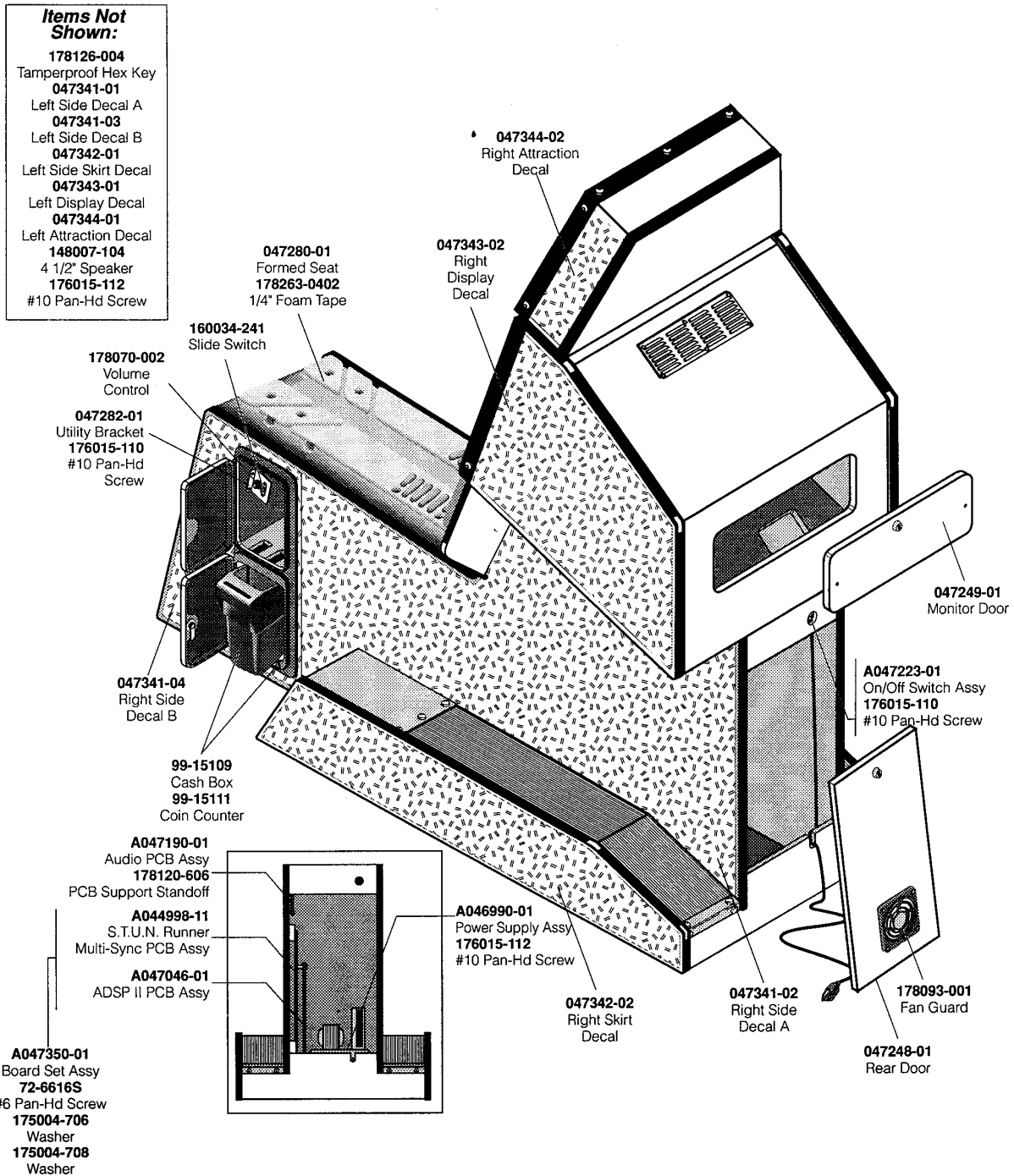

Figure 4-1 Cabinet-Mounted Assemblies, Front View
A046565-01 D

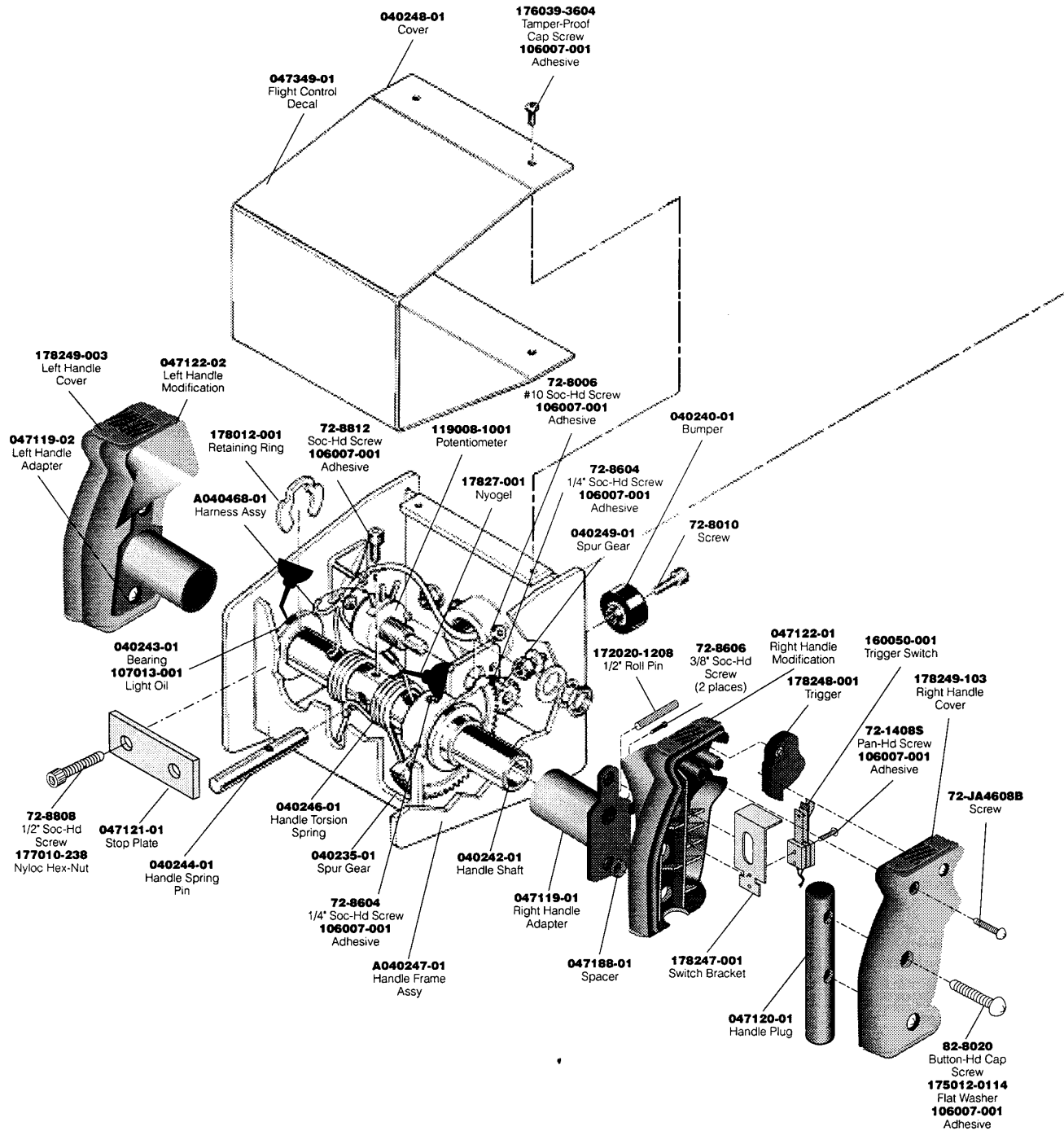

**Figure 4-1 Cabinet-Mounted Assemblies, Rear View
A046565-01 D**

Cabinet-Mounted Assemblies Parts List

Part No.	Description	Part No.	Description
A042562-02	Flight Control Assembly	139017-204	19-Inch Color Raster, Standard Resolution Video Display
A046349-01	Program Plug Assembly	148007-104	4 1/2-Inch-Diameter 8 Ω, 10-Watt Speaker
A046990-01	Power Supply Assembly	160044-001	Gold Snap-Action Switch
A047190-01	Audio PCB Assembly	170003-001	15-Watt, 18-Inch Fluorescent Light
A047222-01	Component Bracket Assembly	171086-001	18-Inch Fluorescent Lamp Fixture
A047223-01	Assembly On/Off Switch	171093-001	25¢/25¢ Coin Door Assembly
A047229-01	Cabinet Assembly	175004-706	Fiber Washer
A047322-01	Main Harness Assembly	175004-708	Fiber Washer
A047323-01	Seat Harness Assembly	176013-212	#10 x 3/4-Inch Tapping Screw
A047324-01	+5-Volt Harness Assembly	176015-110	#10 x 5/8-Inch Pan-Head Self-Tapping Screw
A047325-01	Video Harness Assembly	176015-112	#10 x 3/4-Inch Pan-Head Self-Tapping Screw
A047326-01	Component/Audio Harness Assembly	176019-220	#8 x 1 1/4-Inch Screw
A047327-01	Start Harness Assembly	176020-220	#8 x 1 1/4-Inch Black Screw
A047328-01	Speaker Harness Assembly	176027-4424	1/4-20 x 1.50-Inch Zinc Lock Hex Washer Screw
A047330-01	AC Harness Assembly	176038-4412	1/4-20 x 3/4-Inch Tamper-Proof Flat-Head Screw
A047350-01	S.T.U.N. Runner Board Set Assembly	177010-244	1/4-20 Polymer Hex Locknut
046989-01	Power Supply Wiring Diagram	178032-002	#10 Screw-Down Wire and Cable Tie
047248-01	Door	178120-606	PCB Support Standoff
047249-01	Monitor Door	178126-004	1/8-Inch Tamper-Proof Hex Key Driver
047274-01	Attraction Shield	178232-001	Fluorescent Lamp Retaining Clip
047275-01	Display Shield	178237-003	Black Nylon Button Assembly
047276-01	Attraction Frame	178263-0402	1/4 x 1/8-Inch Foam Tape
047277-01	Display Frame	178282-001	Cap Washer Fastener
047279-01	Formed Dash	178282-002	5/8-Inch Red Fastener Cap
047280-01	Formed Seat	72-5536	1/4-20 x 2 1/4-Inch Hex Head Bolt
047281-01	Control Bracket	72-6616S	#6 x 1-Inch Pan-Head Deep Thread Screw
047284-01	Speaker Grille	75-07002	1/4-Inch Fender Washer
047285-01	Light Fixture Panel	75-99515	1/4-20 Nut/Washer Assembly
047286-01	Display Bezel		
047286-02	Speaker Bezel		
047321-01	Main Wiring Diagram		
047333-01	Installation Harness		
047346-01	Attraction Decal		
047347-01	Start Button Decal		
047347-02	Atari Logo Decal		
047349-01	Flight Control Decal		
			<i>These are the technical documents for the S.T.U.N. Runner game:</i>
		SP-338	S.T.U.N. Runner Schematic Package
		ST-338	S.T.U.N. Runner Self-Test Label
		TM-296	Wells-Gardner 19-Inch Standard-Resolution Color Video Display Service Manual
		TM-338	S.T.U.N. Runner Operator's Manual





**Figure 4-2 Flight Control Assembly
A042562-02 B**

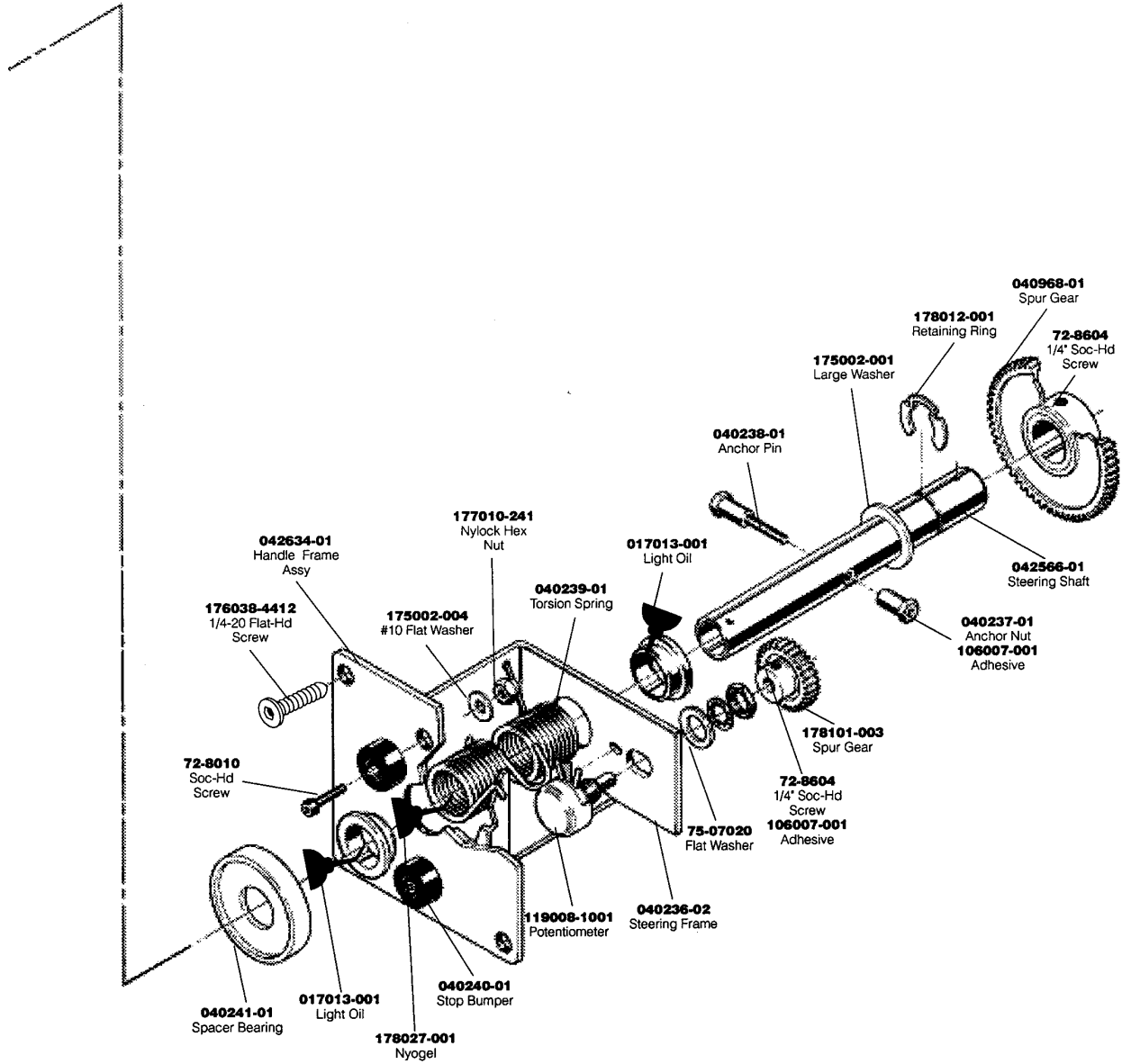
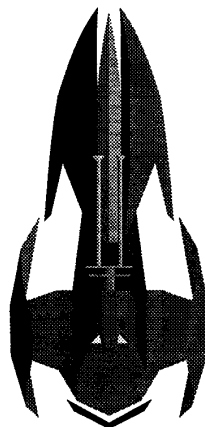
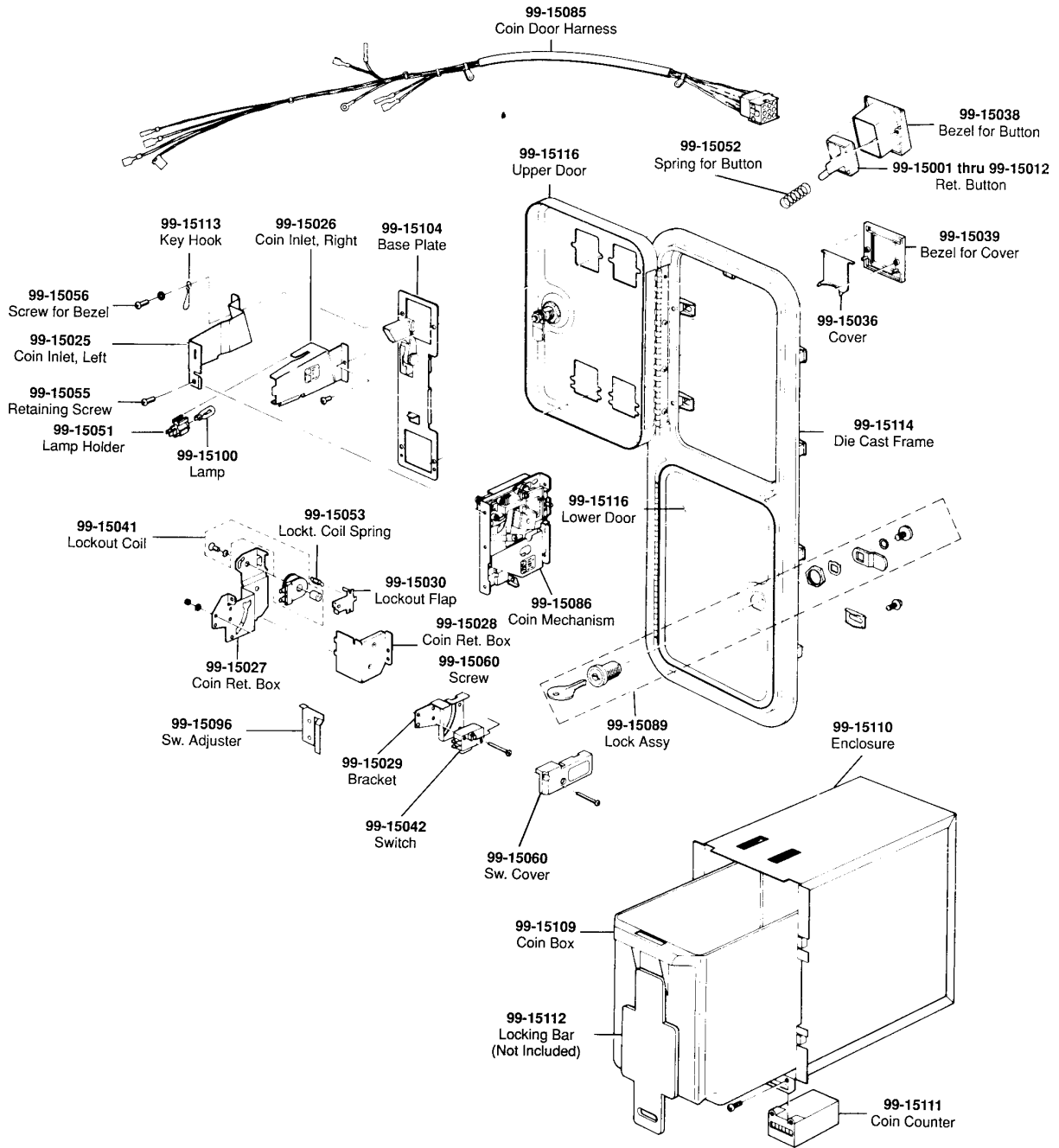

Figure 4-2 Flight Control Assembly, Continued
A042562-02 B

Flight Control Assembly Parts List

Part No.	Description	Part No.	Description
A040468-01	Flight Control Harness Assembly	042634-01	Handle Frame
72-1408S	#4-40 x 1/2-Inch Pan-Head Machine Screw	047119-01	Right Handle Adapter
72-8006	#10-32 x 3/8-Inch Socket-Head Cap Screw		
72-8010	#10-32 x 5/8-Inch Socket-Head Cap Screw	047119-02	Left Handle Adapter
		047120-01	Handle Plug
72-8604	#6-32 x 1/4-Inch Socket-Head Cap Screw	047121-01	Stop Plate
72-8606	#6-32 x 3/8-Inch Socket-Head Cap Screw	047122-01	Right Handle Modification
72-8808	#8-32 x 1/2-Inch Socket-Head Cap Screw		
72-8812	#8-32 x 3/4-Inch Socket-Head Cap Screw	047122-02	Left Handle Modification
		047188-01	Spacer
72-JA4608B	#6-19 Black Screw	106007-001	Penetrating Adhesive
75-07020	Flat Washer	107013-001	Light Oil Lubricant
78-1701	Lubricant		
82-8020	#10-32 x 1 1/4-Inch Button-Head Cap Screw	119008-1001	5 K Ω Potentiometer
		160050-001	Trigger Switch
040235-01	60-Tooth Spur Gear with Hub	172020-1208	3/16-Inch Diameter x 1/2-Inch Spring Roll Pin
040236-02	Steering Frame	175002-001	Large Washer for .750-Inch-Diameter Shaft
040237-01	Anchor Nut		
040238-01	Anchor Pin	175002-004	#10 Flat Washer
		175012-0114	Flat Washer
040239-01	Steering Torsion Spring	176039-3604	#6-32 x 1/4-Inch Tamper-Proof Button-Head Socket Screw
040240-01	Stop Bumper	177010-238	#8-32 Nyloc Hex Nut
040241-01	Spacer Bearing		
040242-01	Handle Shaft	177010-241	#10-32 Nyloc Hex Nut
		178012-001	Retaining Ring for .750-Inch-Diameter Shaft
040244-01	Handle Spring Pin	178027-001	Nyogel (Heavy Lubricant)
040246-01	Handle Torsion Spring	178065-100	4-Inch Wire and Cable Tie
040248-01	Cover		
040249-01	14-Tooth Spur Gear with Hub	178068-001	3/4-Inch Cable Tie Mount
		178247-001	Switch Bracket
040968-01	28-Tooth Spur Gear with Hub	178248-001	Trigger
042566-01	Steering Shaft		

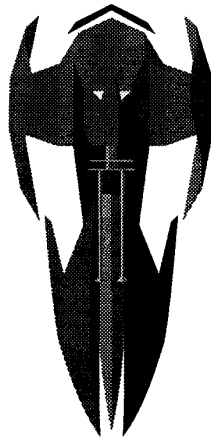

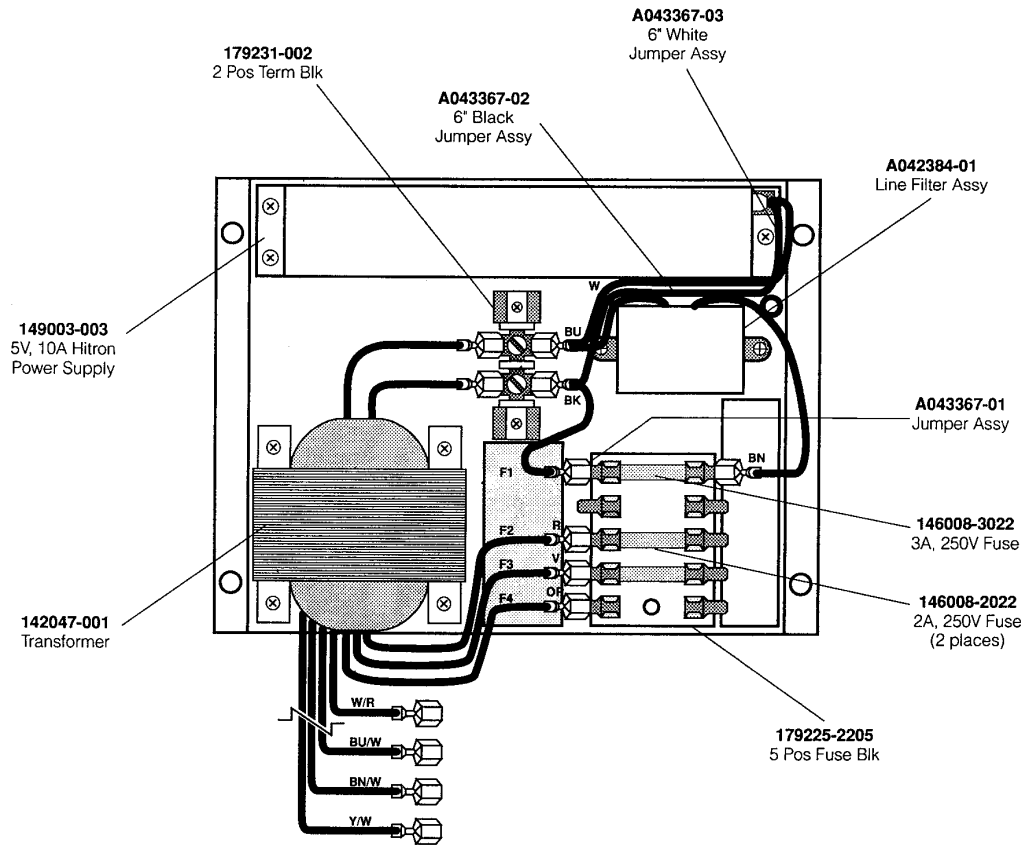

**Figure 4-3 Coin Acceptors, Inc. Coin Door Assembly
171027-001 A**

Coin Acceptors, Inc. Coin Door Assembly Parts List

Part No.	Description	Part No.	Description
160057-001	Coin Switch	99-10081	Key Holder
70-11-47	Miniature Bayonet Lamp	99-10096	Fastener
72-9406S	#4-40 x 3/8-Inch Truss-Head Screw	99-10104	Bar Retainer
72-HA1404C	#4-40 x 1/4-Inch Pan-Head Screw	99-10105	Bar
72-JA1405B	#4-40 x .31-Inch Pan-Head Screw	99-10115	Spring
75-1412S	#4-40 x 3/4-Inch Pan-Head Screw	99-10116	Plastic Coin Return Lever
75-994S	#4-40 Locknut	99-10117	Steel Coin Return Door
99-10008	Retainer	99-10139	Coin Door
99-10042	Coin Switch Assembly for Belgian 5 Fr and U.S. 25¢	99-10140	Coin Door Inner-Panel Assembly
99-10043	Coin Switch Assembly for German 1 DM, Japanese 100 Yen, Swiss 1 Fr	99-10141	Die-Cast Coin Return Cover
99-10044	Coin Switch Assembly for German 2 DM, Italian 100 L, U.S. \$1.00	99-10143	Coin Door Frame
99-10045	Coin Switch Assembly for Australian \$.20, German 5 DM, British 10 P	99-10144	Channel Clip
99-10068	Coin Return Chute	99-10147	Harness
99-10075	Switch Wire (included in coin switch assembly 99-10043)	99-10148	Lock Assembly
99-10076	Switch Wire (included in coin switch assembly 99-10042)	99-10149	Service Door
99-10077	Switch Wire (included in coin switch assembly 99-10044)	99-10150	Switch Cover
99-10078	Switch Wire (included in coin switch assembly 99-10045)	99-10151	Left Coin Inlet
99-10080	Lamp Socket	99-10152	Right Coin Inlet
		99-10153	Coin Return Box
		99-10154	Bracket Assembly
		99-10160	1-Inch Wide Die-Cast Coin Inlet Housing
		99-10161	25¢ Amber Side-Entry Coin Button Assembly
		99-15066	Screw for Clamp
		171006-035	Metal Coin Mechanism for U.S. 25¢





**Figure 4-4 Power Supply Assembly
A046990-01 B**

Power Supply Assembly Parts List

Part No.	Description	Part No.	Description
A042384-01	Line Filter Assembly	146008-2022	2 Amp, 250v Slow Blow Fuse
A043367-01	Jumper Assembly	146008-3022	3 Amp, 250v Slow Blow Fuse
A043367-02	6-Inch Black Jumper Assembly	149003-003	5-Volt , 10-Amp Hitron Switching Power Supply (See Below)
A043367-03	6-Inch White Jumper Assembly	178065-101	5.5-Inch Wire and Cable Tie
72-HA606S	#6-32 x 3/8-Inch Screw	179225-2205	5-Position Fuse Block
72-HA4806S	#8-32 x 3/8-Inch Screw	179231-002	2-Position Terminal Block
046924-01	Base Chassis Power Supply		
142047-001	Transformer		

Hitron 5 Volt, 10 Amp Power Supply Subassembly Parts List

Part No.	Description	Part No.	Description
Transistors			
99-211002	Transistor, NPN, 2SC1413A	99-211024	Resistor, Carbon Film, 470 Ohm, 5%, 1/4W
99-211003	Transistor, NPN, PE8050B	99-211025	Resistor, Carbon Film, 47 Ohm, 5%, 1/4W
99-211004	Transistor, PNP, PE8550B	99-211026	Resistor, Carbon Film, 330 Ohm, 5%, 1/4W
99-211062	Transistor, 2SD725	99-211027	Resistor, Carbon Film, 5.6 Ohm, 5%, 1/4W
99-211063	Transistor, PE8550B	99-211028	Resistor, Carbon Film, 8.2 Ohm, 5%, 1/4W
		99-211029	Resistor, Carbon Film, 10 Ohm, 5%, 1/4W
Diodes			
99-211005	Diode, Schottky, S10SC4M	99-211030	Resistor, Carbon Film, 39 Ohm, 5%, 1/4W
99-211006	Diode, Fast Recovery, 30DF1	99-211031	Resistor, Carbon Film, 56 Ohm, 5%, 1/4W
99-211007	Diode, Zener, 1N752A	99-211032	Resistor, Carbon Film, 1K Ohm, 5%, 1/4W
99-211008	Diode, Rectifier, 1N4006	99-211033	Resistor, Metal Film, 2K Ohm, 2%, 1/4W
99-211009	Diode, Fast Recovery, RPG10B	99-211034	Resistor, Carbon Film, 180K Ohm, 5%, 1W
99-211010	Diode, Fast Recovery, RPG10K	99-211035	Resistor, Carbon Film, 2K Ohm, 5%, 1/4W
99-211011	Diode, Fast Recovery, RPG15B	99-211065	Resistor, Wire Wound, 27 Ohm, 5%, 2W
99-211012	Diode, Switching, 1N4148	99-211066	Resistor, Carbon Film, 6.8 Ohm, 5%, 1/2W
99-211064	Diode, S15SC4M	99-211067	Resistor, Carbon Film, 12 Ohm, 5%, 1/4W
99-211076	Diode, 31DQ04	99-211068	Resistor, Carbon Film, 2.4 Ohm, 5%, 1/2W
99-211013	Rectifier, Silicon Controlled, S2800	99-211077	Resistor, 470 Ohm, 1/2W, 5%
		99-211078	Resistor, 120K Ohm, 1W, 5%
Resistors		Capacitors	
99-211014	Potentiometer, Trimming, 3K Ohm	99-211036	Capacitor, Metal Film, 0.047 μ F, 250V
99-211015	Resistor, Wire Wound, 50 Ohm, 5%, 2W	99-211037	Capacitor, Metal Film, 0.22 μ F, 100V
99-211016	Resistor, Wire Wound, 150 Ohm, 5%, 2W	99-211038	Capacitor, Metal Film, 0.1 μ F, 400V
99-211017	Resistor, Wire Wound, 33 Ohm, 5%, 2W	99-211039	Capacitor, Metal Film, 0.022 μ F, 100V
99-211018	Resistor, Wire Wound, 0.47 Ohm, 5%, 2W	99-211040	Capacitor, Ceramic, 1800 PF, 2KV, Z5V
99-211019	Resistor, Wire Wound, 120 Ohm, 5%, 2W	99-211041	Capacitor, Ceramic, 0.01 μ F, 1KV, Z5U
99-211020	Thermistor, 0.5 Ohm, 5%, 5W	99-211042	Capacitor, Ceramic, 0.001 μ F, 2KV
99-211021	Resistor, 2.2K Ohm, 2%, 1/4W	99-211043	Capacitor, Ceramic, 470 PF, 1KV, Z5P
99-211022	Resistor, Carbon Film, 330 Ohm, 5%, 1/2W	99-211044	Capacitor, Electrolytic, 470 μ F, 25V
99-211023	Resistor, Carbon Film, 270 Ohm, 5%, 1/2W		

**Hitron 5 Volt, 10 Amp Power Supply Subassembly
Parts List**

Part No.	Description	Part No.	Description
99-211045	Capacitor, Electrolytic, 220 μ F, 25V	99-211086	Inductor, 0.75 MH
99-211046	Capacitor, Electrolytic, 100 μ F, 200V	99-211087	Inductor, 2.2 μ H
99-211047	Capacitor, Electrolytic, 1000 μ F, 25V	99-211088	Inductor, 60 MH
		Transformers	
99-211048	Capacitor, Electrolytic, 2200 μ F, 16V	99-211075	Transformer, Power
99-211049	Capacitor, Ceramic, 4700 μ F, 400V	99-211083	Transformer, Power
99-211069	Capacitor, Electrolytic, 2200 μ F, 16V	99-211089	Transformer, 4.75 MH
99-211070	Capacitor, Electrolytic, 220 μ F, 25V	99-211092	Transformer
99-211079	Capacitor, DE7100F22M	99-211055	Transformer
99-211080	Capacitor, 1000 μ F, 35V		
		Miscellaneous	
99-211081	Capacitor, 470 μ F, 25V	99-211001	Regulator, UA431AWC
99-211082	Capacitor, 220 μ F, 16V	99-211056	Fuse, 2A, 250V
99-211090	Capacitor, Ceramic, 1000 PF, 2KV	99-211057	Terminal Block, 8-CKT
99-211091	Capacitor, Electrolytic, 2200 μ F, 10V	99-211058	Fuse, 2A, 250V, Semko
Inductors			
99-211050	Inductor, 7 μ H	99-211059	Heat Sink
99-211051	Inductor, 7 μ H, 35MM	99-211060	Fuse Holder, 6.35MM
99-211052	Inductor, 15 MH	99-211061	Heatsink, 1.5MM
99-211053	Inductor, 1.5 MH	99-211072	Fuse Holder, 5.2X20
99-211054	Inductor, 2.2 μ H	99-211073	Fuse, 2A, 125V
99-211071	Inductor, 9.8 μ H	99-211074	Terminal Block, 9-CKT
99-211084	Inductor, 8 μ H		
99-211085	Inductor, 9.8 μ H		

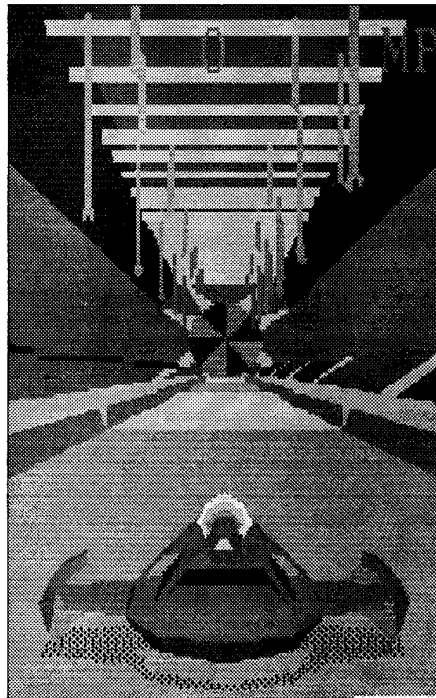

N

O

T

E

S

S.T.U.N. Runner Multisync PCB Assembly Parts List

Designator	Description	Part No.	Designator	Description	Part No.
	Integrated Circuits				
20P	Integrated Circuit, 74ALS574	137548-001	135K	Integrated Circuit, 74AS32	137487-001
20S, 20U, 20W	Integrated Circuit, 74AS823	137513-001	135M	Integrated Circuit, 74LS74	137023-001
30B	Integrated Circuit, 74LS374	137144-001	135P	Integrated Circuit, 74AS573	137547-001
30P	Integrated Circuit, 74LS245	137134-001	135U	Integrated Circuit, 74AS00	137480-001
			135W	Integrated Circuit, 74AS573	137547-001
30S, 30U, 30W	Integrated Circuit, 2149, 45 nsec	137199-002	135Y	Integrated Circuit, 74LS259	137137-001
30Y	Integrated Circuit, 74LS245	137134-001	140C	Integrated Circuit, 74LS244	137038-001
40H	Integrated Circuit, 74LS123	137268-001	140H	Integrated Circuit, 74LS393	137146-001
40S, 40U, 40W	Integrated Circuit, 2149, 45 nsec	137199-002	140K	Integrated Circuit, 74F11	137583-001
40Y	Integrated Circuit, 74LS245	137134-001	140M	Integrated Circuit, 74ALS74	137156-001
45B	Integrated Circuit, ADC0809	137243-001	140P	Integrated Circuit, 74LS244	137038-001
50H	Integrated Circuit, 74LS123	137268-001	140U	Integrated Circuit, 74AS08	137484-001
50S, 50U, 50W	Integrated Circuit, 74ALS574	137548-001	150C	Integrated Circuit, 74LS245	137134-001
50Y	Integrated Circuit, 74AS573	137547-001	150E	Integrated Circuit, 74LS244	137038-001
60B	Integrated Circuit, 74LS244	137038-001	150H	Integrated Circuit, 74LS74	137023-001
60P,60S,60U,60W	Integrated Circuit, VRAM, 64K x 4, 150 nsec (Acceptable substitute is 64K x 4, 120 nsec VRAM Integrated Circuit, part no. 137553-001)	137553-002	150K	Integrated Circuit, 74LS20	137060-001
60Y	Integrated Circuit, 74AS138	137522-001	150S-GSP	Integrated Circuit, 34010-50	137538-002
65C	Integrated Circuit, 74LS259	137137-001	150U	Integrated Circuit, 74AS573	137547-001
70P, 70S, 70U, 70W	Integrated Circuit, VRAM, 64K x 4, 150 nsec (Acceptable substitute is 64K x 4 120 nsec VRAM Integrated Circuit, part no. 137553-001)	137553-002	150W	Integrated Circuit, 74F04	137437-001
70Y	Integrated Circuit, 74AS08	137484-001	150Y	Integrated Circuit, 74F161	137343-001
75C	Integrated Circuit, 74LS259	137137-001	160C	Integrated Circuit, 74LS244	137038-001
75H	Integrated Circuit, 74LS14	137056-001	160E	Integrated Circuit, 74ALS161	137470-001
80M	Integrated Circuit, 74ALS138	137517-001	160H	Integrated Circuit, 74ALS32	137464-001
85P,85S,85U,85W	Integrated Circuit, VRAM, 64K x 4, 150 nsec (Acceptable substitute is 64K x 4, 120 nsec VRAM Integrated Circuit, part no. 137553-001)	137553-002	160K	Integrated Circuit, 74ALS138	137517-001
90M	Integrated Circuit, 74ALS08	137460-001	160M	Integrated Circuit, 74F04	137437-001
95P,95S,95U,95W	Integrated Circuit, VRAM, 64K x 4, 150 nsec Note: Acceptable substitute is 64K x 4, 120 nsec VRAM Integrated Circuit, part no. 137553-001	137553-002	160U	Integrated Circuit, 74AS32	137487-001
100M	Integrated Circuit, 74ALS161	137470-001	160W	Integrated Circuit, 74LS74	137023-001
110C	Integrated Circuit, 7406	137052-001	170C	Integrated Circuit, 74LS245	137134-001
110K	Integrated Circuit, 74ALS138	137517-001	170E	Integrated Circuit, 74LS244	137038-001
120H	Integrated Circuit, 74F74	137436-001	170H	Integrated Circuit, 74LS148	137417-001
120K	Integrated Circuit, 74LS393	137146-001	170K	Integrated Circuit, 74ALS161	137470-001
120M	Integrated Circuit, 74ALS574	137548-001	175R	Integrated Circuit, 74LS245	137134-001
120P	Integrated Circuit, 74AS573	137547-001	175T	Integrated Circuit, 74AS08	137484-001
120S-PSP	Integrated Circuit, 34012-50	137559-001	175W	Integrated Circuit, SCOM	137526-001
120U	Integrated Circuit, 74F244	137502-001	180C	Integrated Circuit, 74ALS138	137517-001
120W, 120Y	Integrated Circuit, 74AS573	137547-001	180E	Integrated Circuit, 74ALS139	137467-001
135C, 135H	Integrated Circuit, 74F74	137436-001	190C	Integrated Circuit, 74LS393	137146-001
			190E	Integrated Circuit, 74AS00	137480-001
			190K	Integrated Circuit, 68010	137414-002
			190N	Integrated Circuit, 74LS245	137134-001
			200C, 200D	Integrated Circuit, RAM, 8K x 8, 150 nsec	137535-006
			200E	Integrated Circuit, 48Z02-15, RAM	137442-150
			200F	Integrated Circuit, 74LS245	137134-001
			200H, 200J	Integrated Circuit, 74LS244	137038-001
			200K	Integrated Circuit, SLAPSTIC	137412-117

S.T.U.N. Runner Multisync PCB Assembly, Continued Parts List

Designator	Description	Part No.	Designator	Description	Part No.
200L	Integrated Circuit, 74ALS32	137464-001	C274	Capacitor, 47 pF, 100 V, Ceramic	122016-470
200M	Integrated Circuit, 74ALS138	137517-001	C323-C326	Capacitor, 10 pF, 100 V, Ceramic	122016-100
200N, 200P	Integrated Circuit, 74LS245	137134-001	C332, C333, C343	Capacitor, .1 μ F, 50 V, Ceramic	122002-104
200R	Integrated Circuit, EPROM	136070-2102	C344-C347	Capacitor, 100 pF, 100 V, Ceramic	122016-101
200S	Integrated Circuit, EPROM	136070-2104	C359, C360	Capacitor, .001 μ F, 50 V, \pm 10%	122015-102
200T	Integrated Circuit, EPROM	136070-2106	Diodes		
200U	Integrated Circuit, EPROM	136070-2108	CR1, CR2, CR6, CR9-CR12	Diode, MV5053, Light-Emitting	131027-002
200V	Integrated Circuit, EPROM	136070-2110		Diode, 1N4002	131048-002
200W	Integrated Circuit, EPROM	136070-2112	CR13	Diode, MV5053, Light-Emitting	131027-002
200Y	Integrated Circuit, EPROM	136070-1116	CR14	Diode, 1N4002	131048-002
210C, 210D	Integrated Circuit, RAM, 8K x 8, 150 nsec	137535-006	CR18, CR23	Diode, 1N4002	131048-002
210E	Integrated Circuit, 48Z02-15, RAM	137442-150	Transistors		
210F	Integrated Circuit, 74LS245	137134-001	Q1, Q2	Transistor, 2N6044	133042-001
210H, 210J, 210K	Integrated Circuit, 74LS244	137038-001	Q5	Transistor, 2N3904	133041-001
210L, 210M	Integrated Circuit, 74LS245	137134-001	Q6	Transistor, 2N3906	133040-001
210N	Integrated Circuit, 74LS244	137038-001	Q7	Transistor, 2N3904	133041-001
210P	Integrated Circuit, 74LS245	137134-001	Q8	Transistor, 2N3906	133040-001
210R	Integrated Circuit, EPROM	136070-2101	Q9	Transistor, 2N3904	133041-001
210S	Integrated Circuit, EPROM	136070-2103	Q10	Transistor, 2N3906	133040-001
210T	Integrated Circuit, EPROM	136070-2105	Q11	Transistor, 2N3904	133041-001
210U	Integrated Circuit, EPROM	136070-2107	Resistors		
210V	Integrated Circuit, EPROM	136070-2109	R1-R10	Resistor, 100 Ohm, \pm 5%, 1/4 W	110000-101
210W	Integrated Circuit, EPROM	136070-2111	R29-R45	Resistor, 1 K Ohm, \pm 5%, 1/4 W	110000-102
210Y	Integrated Circuit, EPROM	136070-1115	R46-R48	Resistor, 470 Ohm, \pm 5%, 1/4 W	110000-471
Capacitors			R49, R50-R54	Resistor, 4.7 K Ohm, \pm 5%, 1/4 W	110000-472
C1	Capacitor, 100 μ F, 35 V, Electrolytic	124000-107	R55	Resistor, 100 Ohm, \pm 5%, 1/4 W	110000-101
C2	Capacitor, .01 μ F, 50 V, Ceramic	122002-103	R57-R60	Resistor, 1 K Ohm, \pm 5%, 1/4 W	110000-102
C3-C14,	Capacitor, .1 μ F, 50 V, Ceramic	122002-104	R61	Resistor, 4.7 K Ohm, \pm 5%, 1/4 W	110000-472
C16, C19-C21, C24-C43, C44-C47	Capacitor, .001 μ F, 50 V, \pm 10%	122015-102	R62, R63	Resistor, 220 Ohm, \pm 5%, 1/4 W	110000-221
C65-C78, C86, C87, C94-C106, C116, C117, C123, C124, C131-C137	Capacitor, .1 μ F, 50 V, Ceramic	122002-104	R68	Resistor, 1 K Ohm, \pm 5%, 1/4 W	110000-102
C138, C139	Capacitor, 1000 pF, 100 V, Ceramic	122016-102	R70-R73	Resistor, 220 Ohm, \pm 5%, 1/4 W	110000-221
C140, C141	Capacitor, .1 μ F, 50 V, Ceramic	122002-104	R74, R75	Resistor, 10 K Ohm, \pm 5%, 1/4 W	110000-103
C142	Capacitor, .22 μ F, 50 V, Ceramic	122015-224	R76	Resistor, 220 Ohm, \pm 5%, 1/4 W	110000-221
C143, C144	Capacitor, .1 μ F, 50 V, Ceramic	122002-104	R77, R78	Resistor, 4.7 K Ohm, \pm 5%, 1/4 W	110000-472
C145	Capacitor, 10 μ F, 35 V, Electrolytic	124000-106	R79	Resistor, 47 K Ohm, \pm 5%, 1/4 W	110000-473
C146, C155, C158-C185, C187-C189, C193-C202, C204-C227	Capacitor, .1 μ F, 50 V, Ceramic	122002-104	R80, R81	Resistor, 1 K Ohm, \pm 5%, 1/4 W	110000-102
C228	Capacitor, .001 μ F, 50 V, \pm 10%	122015-102	R82, R83	Resistor, 470 Ohm, \pm 5%, 1/4 W	110000-471
C229	Capacitor, 47 pF, 100 V, Ceramic	122016-470	R84-R88	Resistor, 10 K Ohm, \pm 5%, 1/4 W	110000-103
C230-C238, C243-C249	Capacitor, .1 μ F, 50 V, Ceramic	122002-104	R89-R96	Resistor, 33 Ohm, \pm 5%, 1/4 W	110000-330
C250	Capacitor, 47 pF, 100 V, Ceramic	122016-470	R97	Resistor, 3.3 K Ohm, \pm 5%, 1/4 W	110000-332
C251-C259, C264-C273	Capacitor, .1 μ F, 50 V, Ceramic	122002-104	R98-R101	Resistor, 100 Ohm, \pm 5%, 1/4 W	110000-101
			R102-R107	Resistor, 33 Ohm, \pm 5%, 1/4 W	110000-330
			R108	Resistor, 3.3 K Ohm, \pm 5%, 1/4 W	110000-332
			R109-R111	Resistor, 100 Ohm, \pm 5%, 1/4 W	110000-101
			R112	Resistor, 3.3 K Ohm, \pm 5%, 1/4 W	110000-332
			R113-R115	Resistor, 100 Ohm, \pm 5%, 1/4 W	110000-101
			R116-R123	Resistor, 33 Ohm, \pm 5%, 1/4 W	110000-330

S.T.U.N. Runner Multisync PCB Assembly, Continued Parts List

Designator	Description	Part No.	Designator	Description	Part No.
R125-R131	Resistor, 1 K Ohm, ±5%, 1/4 W	110000-102	J4-J6	Connector, 11 Circuit, Header, .100 Ctr	179118-011
R132	Resistor, 4.7 K Ohm, ±5%, 1/4 W	110000-472	J7	Connector, Header, 60 Circuit, .1 Ctr	179021-060
R134	Resistor, 1 K Ohm, ±5%, 1/4 W	110000-102	J8-J10	Connector, 11 Circuit, Header, .100 Ctr	179118-011
R155	Resistor, 0 Ohm, ±5%, 1/4 W	110005-001	SPEED	Connector, 6 Ckt, Hdr, .100 Ctr	179177-006
R164-R167	Resistor, 470 Ohm, ±5%, 1/4 W	110000-471	VCLK.	Connector, 6 Ckt, Hdr, .100 Ctr	179177-006
			Sockets		
R168-R171	Resistor, 10 K Ohm, ±5%, 1/4 W	110000-103	120S-PSP, 150S-GSP	Socket, 68 Pin	179237-068
R177, R178	Resistor, 100 Ohm, ±5%, 1/4 W	110000-101	190K	Socket, 64 Pin, .900"	179256-064
R194	Resistor, 10 K Ohm, ±5%, 1/4 W	110000-103	200E	Socket, 24 Pin, .600"	179257-024
RN1, RN2	Resistor Network, 470 x 9 Ohm, ±5%, 1/8 W, SIP (10-Pin)	118010-471	200K	Socket, 20 Pin, .300"	179259-020
RN3-RN5	Resistor Network, R2R Ladder	118015-001	200R, 200S, 200T, 200U, 200V, 200W, 200X, 200Y	Socket, 28 Pin, .600"	179257-028
RN6	Resistor Network, 4.7K x 9 Ohm, ±5%, 1/8 W, SIP (10-Pin)	118010-472	210E	Socket, 24 Pin, .600"	179257-024
Connectors			210R, 210S, 210T, 210U, 210V, 210W, 210X, 210Y	Socket, 28 Pin, .600"	179257-028
BCLK, SPEED, VCLK	Connector, Rcpt, 2 Ckt Note: Place receptable for SPEED on "A" "B", BCLK on "QB", and VCLK on "QB/2."	179178-002	Crystal		
BCLK.	Connector, 4 Ckt, Hdr, .100 Ctr	179177-004	XOSC2	Crystal, 48 MHz, Oscillator Module	144008-003
SCOM	Connector, 11 Circuit, Header, .100 Ctr	179118-011	Oscillator		
J1	Connector, 12 Circuit, Header .250 Ctr	179069-012	XOSC4	Oscillator, 40 MHz	144008-004
			XOSCI	Oscillator, 32 MHz	144008-002
			Miscellaneous		
			SW1	Switch, 8-Position DIP Test Point	160031-008 179051-001

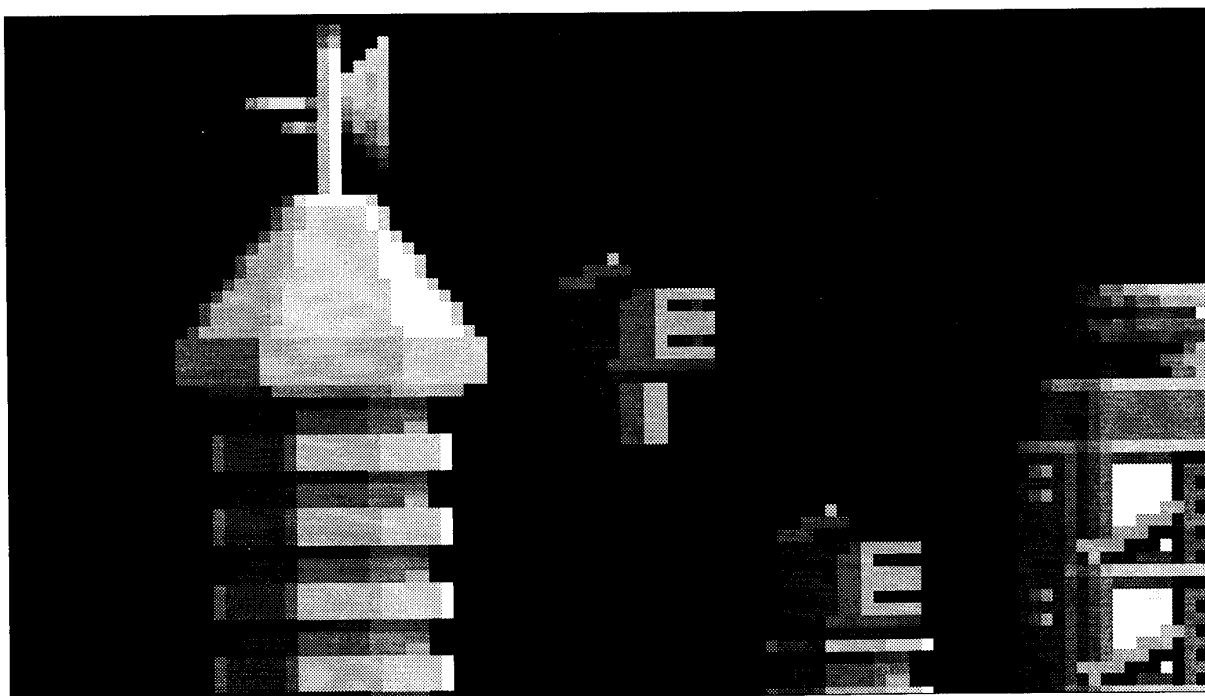

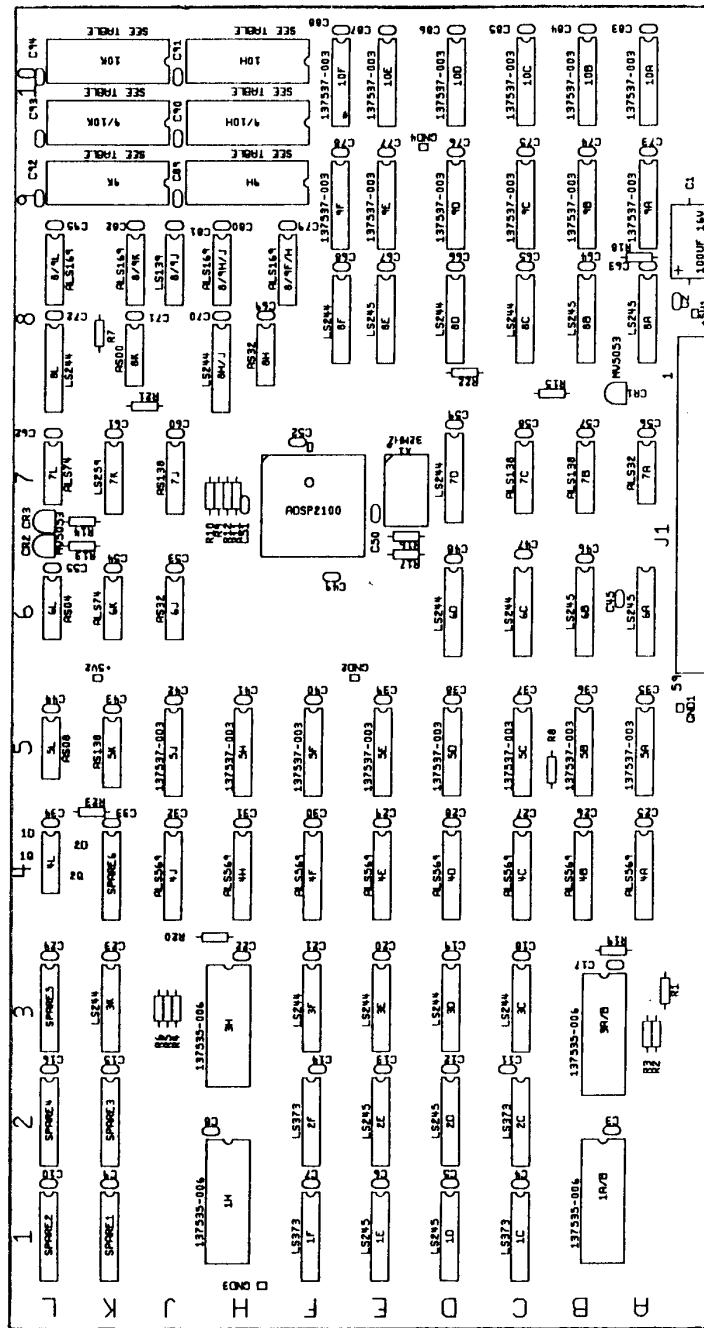
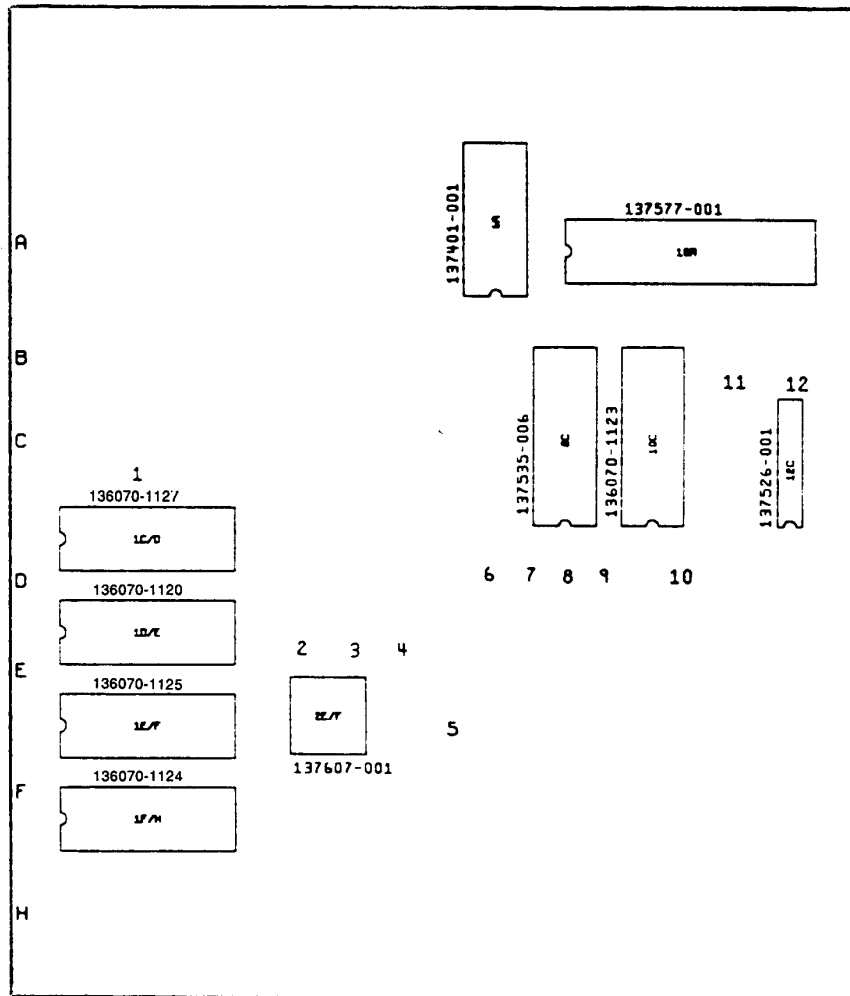

Figure 4-6 ADSP II PCB Assembly
A047046-02 C

ADSP II PCB Assembly Parts List

Designator	Description	Part No.	Designator	Description	Part No.
Integrated Circuits					
ADSP2100	Integrated Circuit, ADSP-2100, 16-Bit DSP, PQFP	137629-001	7K	Integrated Circuit, 74LS259	137137-001
1A/B	Integrated Circuit, RAM, 8K x 8, 150 nsec	137535-006	7L	Integrated Circuit, 74ALS74	137156-001
1C	Integrated Circuit, 74LS373	137143-001	8/9F/H, 8/9H/J	Integrated Circuit, 74ALS169	137471-001
1D, 1E	Integrated Circuit, 74LS245	137134-001	8/9J	Integrated Circuit, 74LS139	137097-001
1F	Integrated Circuit, 74LS373	137143-001	8/9K, 8/9L	Integrated Circuit, 74ALS169	137471-001
1H	Integrated Circuit, RAM, 8K x 8, 150 nsec	137535-006	8A, 8B	Integrated Circuit, 74LS245	137134-001
2C	Integrated Circuit, 74LS373	137143-001	8C, 8D	Integrated Circuit, 74LS244	137038-001
2D, 2E	Integrated Circuit, 74LS245	137134-001	8E	Integrated Circuit, 74LS245	137134-001
2F	Integrated Circuit, 74LS373	137143-001	8F	Integrated Circuit, 74LS244	137038-001
3A/B	Integrated Circuit, RAM, 8K x 8, 150 nsec	137535-006	8H	Integrated Circuit, 74AS32	137487-001
3C, 3D, 3E, 3F	Integrated Circuit, 74LS244	137038-001	8H/J	Integrated Circuit, 74LS244	137038-001
3H	Integrated Circuit, RAM, 8K x 8, 150 nsec	137535-006	8K	Integrated Circuit, 74AS00	137480-001
3K	Integrated Circuit, 74LS244	137038-001	8L	Integrated Circuit, 74LS244	137038-001
4A, 4B, 4C, 4D, 4E, 4F, 4H, 4J	Integrated Circuit, 74ALS569	137476-001	9H	Integrated Circuit, EPROM	136070-2120
5A, 5B, 5C, 5D, 5E, 5F, 5H, 5J	Integrated Circuit, SRAM, 4K X 4, 45 ns	137537-003	9K	Integrated Circuit, EPROM	136070-2117
5K	Integrated Circuit, 74AS138	137522-001	9/10H	Integrated Circuit, OTP, 27C512-250	136070-2121
5L	Integrated Circuit, 74AS08	137484-001	9/10K	Integrated Circuit, OTP, 27C512-250	136070-2118
6A, 6B	Integrated Circuit, 74LS245	137134-001	9A, 9B, 9C, 9D, 9E, 9F, 10A, 10B, 10C, 10D, 10E, 10F	Integrated Circuit, SRAM, 4K x 4, 45 ns	137537-003
6C, 6D	Integrated Circuit, 74LS244	137038-001	10H	Integrated Circuit, OTP, 27C512-250	136070-2122
6J	Integrated Circuit, 74AS32	137487-001	10K	Integrated Circuit, OTP, 27C512-250	136070-2119
6K	Integrated Circuit, 74ALS74	137156-001	Capacitors		
6L	Integrated Circuit, 74AS04	137433-001	C1	Capacitor, 100 μ F, 16 V, Electrolytic	124008-107
7A	Integrated Circuit, 74ALS32	137464-001	C2-C95	Capacitor, .1 μ F, 50 V, Ceramic	122002-104
7B, 7C	Integrated Circuit, 74ALS138	137517-001	Diode		
7D	Integrated Circuit, 74LS244	137038-001	CR1-CR3	Diode, MV5053, Light-Emitting	131027-002
7J	Integrated Circuit, 74AS138	137522-001	Resistors		
			R1-R12	Resistor, 10 K Ohm, \pm 5%, 1/4 W	110000-103
			R13, R14	Resistor, 150 Ohm, \pm 5%, 1/4 W	110000-151
			R15	Resistor, 220 Ohm, \pm 5%, 1/4 W	110000-221
			R16-R18	Resistor, 10 K Ohm, \pm 5%, 1/4 W	110000-103
			R19-R23, R48, R49	Resistor, 1 K Ohm, \pm 5%, 1/4 W	110000-102





**Figure 4-7 Stand-Alone Audio II PCB Assembly
A047190-01 B**

Stand-Alone Audio II PCB Assembly Parts List

Designator	Description	Part No.	Designator	Description	Part No.
Integrated Circuits					
1A/B	Integrated Circuit, TDA2030	137301-001	C24-C36	Capacitor, .1 μ F, 50 V, Ceramic	122002-104
1C/D	Integrated Circuit, OTP, 300 ns	136070-2127	C37	Capacitor, .22 μ F, 50 V, Ceramic	122017-224
1D/E	Integrated Circuit, OTP, 300 ns	136070-2126	C38	Capacitor, .0068 μ F, 50 V, Ceramic	122015-682
1E/F	Integrated Circuit, OTP, 300 ns	136070-2125	C39	Capacitor, .22 μ F, 50 V, Ceramic	122017-224
1F/H	Integrated Circuit, OTP, 300 ns	136070-2124	C40, C41	Capacitor, 10 μ F, 25 V, Electrolytic	124009-106
2A	Integrated Circuit, TL084CN	137579-001	C42-C45	Capacitor, .1 μ F, 50 V, Ceramic	122002-104
2E/F	Integrated Circuit, MSM6295 (Surface-Mount)	137607-001	C46	Capacitor, 10 μ F, 25 V, Electrolytic	124009-106
2F/H	Integrated Circuit, 74LS74	137023-001	C47-C49	Capacitor, .1 μ F, 50 V, Ceramic	122002-104
3B/C, 3C/D	Integrated Circuit, TL084CN	137579-001	C50	Capacitor, 100 pF, 100 V, Ceramic	122016-101
3F/H	Integrated Circuit, 74LS86	137079-001	C51	Capacitor, .1 μ F, 50 V, Ceramic	122002-104
4A	Integrated Circuit, YM3012	137402-001	C52-C55	Capacitor, 100 pF, 100 V, Ceramic	122016-101
5E	Integrated Circuit, 74LS174	137122-001	C56-C66	Capacitor, .1 μ F, 50 V, Ceramic	122002-104
5F	Integrated Circuit, 74LS74	137023-001	C67	Capacitor, 39 pF, 100 V, Ceramic	122016-390
5H	Integrated Circuit, 74LS393	137146-001	C68	Capacitor, .1 μ F, 50 V, Ceramic	122002-104
6A	Integrated Circuit, YM2151	137401-001	Diodes		
6B	Integrated Circuit, 4066B	137580-001	CR1, CR2	Diode, MV5053, Light-Emitting	131027-002
7E	Integrated Circuit, 74LS138	137177-001	CR3	Diode, 1N754 A, Zener	131002-001
7F	Integrated Circuit, 74LS14	137056-001	CR4, CR5	Diode, 1N4001	131048-001
7H	Integrated Circuit, 74LS393	137146-001	CR6-CR9	Diode, 1N5401	131051-002
8C	Integrated Circuit, RAM, 8K x 8, 150 nsec	137535-006	CR10	Diode, MV5053, Light-Emitting	131027-002
9E	Integrated Circuit, 74LS273	137040-001	CR11, CR12	Diode, 1N4001	131048-001
10A	Integrated Circuit, 6502 A	137577-001	Heat Sink		
10C	Integrated Circuit, EPROM, 300 nsec	136070-2123	HS1	Heat Sink	178190-032
10E	Integrated Circuit, 74LS240	137251-001	Inductor		
11C	Integrated Circuit, PAL16L8	136056-2101	L1	Inductor, 100 μ H	141002-001
12C	Integrated Circuit, SCOM	137526-001	Transistors		
Capacitors					
C1	Capacitor, .22 μ F, 50 V, Ceramic	122017-224	Q1, Q2	Transistor, 2N3904	133041-001
C2	Capacitor, 22 μ F, 35 V, Electrolytic	124000-226	Q3-Q5	Transistor, 2N5306	133033-001
C3, C4	Capacitor, .1 μ F, 50 V, Ceramic	122002-104	Q6	Transistor, 2N3904	133041-001
C5	Capacitor, .22 μ F, 50 V, Ceramic	122017-224	Resistors		
C6	Capacitor, 3300 μ F, 25 V, Electrolytic, Radial	123003-338	R1	Resistor, 1 Ohm, \pm 5%, 1/8 W	110027-010
C7-C10	Capacitor, .1 μ F, 50 V, Ceramic	122002-104	R2, R3	Resistor, 1 K Ohm, \pm 5%, 1/8 W	110027-102
C11	Capacitor, 10 μ F, 25 V, Electrolytic	124009-106	R4	Resistor, 180 Ohm, \pm 5%, 1/2 W	110001-181
C12-C14	Capacitor, .1 μ F, 50 V, Ceramic	122002-104	R5	Resistor, 22 K Ohm, \pm 5%, 1/8 W	110027-223
C15	Capacitor, 3300 μ F, 25 V, Electrolytic, Radial	123003-338	R6	Resistor, 10 K Ohm, \pm 5%, 1/8 W	110027-103
C16	Capacitor, .001 μ F, 50 V, Ceramic	122002-102	R7	Resistor, 1 K Ohm, \pm 5%, 1/8 W	110027-102
C17	Capacitor, 3300 pF, 50 V	122015-332	R8	Resistor, 10 Ohm, \pm 5%, 1/4 W	110000-100
C18	Capacitor, .0022 μ F, 100 V, Plastic	121022-222	R9	Resistor, 20 K Ohm, \pm 5%, 1/8 W	110027-203
C19	Capacitor, .0068 μ F, 50 V, Ceramic	122015-682	R10, R11	Resistor, 12 K Ohm, \pm 5%, 1/8 W	110027-123
C20	Capacitor, .001 μ F, 50 V, Ceramic	122002-102	R12	Resistor, 6.8 K Ohm, \pm 5%, 1/8 W	110027-682
C22	Capacitor, .015 μ F, 100 V, \pm 5%, Poly, Radial	126009-153	R13	Resistor, 20 K Ohm, \pm 5%, 1/8 W	110027-203
			R14	Resistor, 10 K Ohm, \pm 5%, 1/8 W	110027-103
			R15	Resistor, 6.8 K Ohm, \pm 5%, 1/8 W	110027-682
			R16	Resistor, 16 K Ohm, \pm 5%, 1/8 W	110027-163
			R18	Resistor, 560 Ohm, \pm 5%, 1/8 W	110027-561

Stand-Alone Audio II PCB Assembly, Continued Parts List

Designator	Description	Part No.	Designator	Description	Part No.
R19	Resistor, 470 Ohm, $\pm 5\%$, 1/8 W	110027-471	R59	Resistor, 240 Ohm, $\pm 5\%$, 1/8 W	110027-241
R20, R21	Resistor, 100 K Ohm, $\pm 5\%$, 1/8 W	110027-104	R60	Resistor, 100 K Ohm, $\pm 5\%$, 1/8 W	110027-104
R22	Resistor, 15 K Ohm, $\pm 5\%$, 1/8 W	110027-153	R61	Resistor, 470 Ohm, $\pm 5\%$, 1/8 W	110027-471
R23	Resistor, 7.5 K Ohm, $\pm 5\%$, 1/8 W	110027-752	R62	Resistor, 0 Ohm, $\pm 5\%$, 1/4 W	110005-001
R24	Resistor, 15 K Ohm, $\pm 5\%$, 1/8 W	110027-153	R63	Resistor, 220 Ohm, $\pm 5\%$, 1/8 W	110027-221
R25	Resistor, 30 K Ohm, $\pm 5\%$, 1/8 W	110027-303	R64, R65	Resistor, 150 K Ohm, $\pm 5\%$, 1/8 W	110027-154
R26	Resistor, 10 K Ohm, $\pm 5\%$, 1/8 W	110027-103	Connectors		
R27	Resistor, 47 K Ohm, $\pm 5\%$, 1/8 W	110027-473	ACDC	Connector, 12 Ckt, Header, .156 Ctr, Key 11	179213-012
R28	Resistor, 33 K Ohm, $\pm 5\%$, 1/8 W	110027-333	COIN	Connector, 11-Ckt, Header, .100 Ctr	179118-011
R29	Resistor, 1 K Ohm, $\pm 5\%$, 1/8 W	110027-102	SCOM	Connector, 11 Ckt, Header, .100 Ctr	179118-011
R30	Resistor, 2 K Ohm, $\pm 5\%$, 1/8 W	110027-202	SPKR	Connector, 2 Ckt, Header, .156 Ctr	179213-002
R31	Resistor, 150 K Ohm, $\pm 5\%$, 1/8 W	110027-154	Miscellaneous		
R32	Resistor, 10 K Ohm, $\pm 5\%$, 1/8 W	110027-103		Socket, 20 Pin, .300"	179259-020
R33	Resistor, 68 K Ohm, $\pm 5\%$, 1/8 W	110027-683		Socket, 24 Pin, .600"	179257-024
R34	Resistor, 10 Ohm, $\pm 5\%$, 1/4 W	110000-100		Socket, 28 Pin, .600"	179257-028
R35, R36	Resistor, 7.5 K Ohm, $\pm 5\%$, 1/8 W	110027-752		Socket, 40 Pin, .600"	179257-040
R37	Resistor, 15 K Ohm, $\pm 5\%$, 1/8 W	110027-153	(1A/B)	Nut/Washer Assy, #6-32	75-99516
R38	Resistor, 30 K Ohm, $\pm 5\%$, 1/8 W	110027-303	(1A/B)	Screw, Pan Hd, Cross-Recessed, #6-32 x 3/8" Long	72-1606S
R39, R40	Resistor, 10 K Ohm, $\pm 5\%$, 1/8 W	110027-103	AGND1, ++1005V1, GND1, GND2, CC1+, CC1-, CC2+, CC2-	Test Point	179051-001
R41	Resistor, 1 K Ohm, $\pm 5\%$, 1/8 W	110027-102	SW1	Switch, Slide, SPDT	160040-001
R42	Resistor, 470 Ohm, $\pm 5\%$, 1/8 W	110027-471	VR1	Potentiometer, 10 K Ohm, Horiz	119022-103
R43	Resistor, 1 K Ohm, $\pm 5\%$, 1/8 W	110027-102	X1	Crystal, 3.579 MHz	144007-001
R44	Resistor, 470 Ohm, $\pm 5\%$, 1/8 W	110027-471	(1A/B)	Thermal Compound	78-16001
R45	Resistor, 1 K Ohm, $\pm 5\%$, 1/8 W	110027-102			
R46, R47	Resistor, 10 K Ohm, $\pm 5\%$, 1/8 W	110027-103			
R48-R58	Resistor, 1 K Ohm, $\pm 5\%$, 1/8 W	110027-102			

