

UFO ROBO

DANGER

TM

SERVICE INSTRUCTION



USER INFORMATION
F.C.C. REGULATION COMPLIANCE

This equipment generates, uses, and can radiate radio frequency energy and if not installed and used in accordance with the instruction manual, may cause interference to radio communications.

It has been tested and found to comply with the limits for a CLASS "A" computing device pursuant to subpart J of part 15 of F.C.C. rules, which are designed to provide reasonable protection against such interference when operated in a commercial environment.

F.C.C. requires that the STICKER that comes with the KIT must be on the back of your machine or elsewhere visible when inspected.

SERVICE INFORMATION

NICHIBUTSU will repair and exchange parts or replace P.C.Board in the event of manufacturing defect for ninety day warranty period after original purchase with Nichibutsu.

Mail-in service can be obtained during the warranty period by sending the product postage prepaid, to the nearest distributor or NICHIBUTSU USA CORP. (California).

A purchase receipt or other proof of of date of original purchase will be required before warranty performance is rendered.

It is important that the enclosed registration card to be filled out entirely and sent in for your protection in case of product failure . SEND IN THE CARD TODAY!

HOW TO PLAY

- * Control the LEADER With 8 way joystick .
- * Use FIRE button to destroy all flying enemies and ground fortresses .
- * As FLYING CAPSULES appear , destroy them and as each new COMPONENT is freed - dock with it !
- * Each component increases the combined firepower or special powers of entire ship . LEADER is the main ship and equipped with double forward cannons.
- * Use TRANSFORM button after each component is added for greater fire power . Components will be transformed into a flight formation and shoots beams in multiples .
- * Only after all three components are docked , player will become UFO ROBO DANGAR and can retrieve awesome desolation gun . UFO HANGARS will now appear , destroy hangars and dock with UFO for super fire power formation.
- * The number of times that you can transform into formation is indicated by F at the bottom center of the screen .

POWER SUPPLY

This P.C.Board requires power supply of
* + 5 V 5 A (+ 2%) for game logics
* +12 V 1 A (+ 10%) for audio IC only

It is very important that exactly + 5 V to be attained and checked at the edge connector pin # 10 (positive) and pin # 15 (negative) with a voltmeter .

Note :

In case of any malfunction , such as self-test problems or sound problems appears , first check + 5 V at the edge connector with logic board PLUGGED IN .

COIN COUNTER

DANGAR logic board is designed to use with 5 V or 6 V type counter , absolutely NO 12 V or 24 V type counter should be used .

Some uprights have a 12 V counter connected directly to coin switch which will destroy the IC at location 6E & 7E , so please check the connection of the counter very carefully before power is turned on .

* If 12 V counter is used :

1. Don't connect counter directly to COIN SW (pin # H)
2. Connect counter to COUNTER 1 (pin # V)
3. Disconnect diode D1 & D2 on logic board
4. Connect a diode parallel with counter as figured below

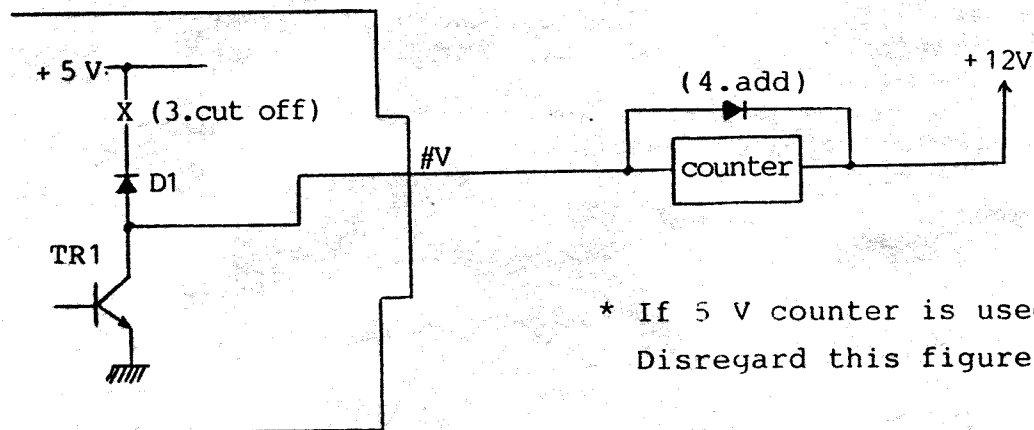

* If 5 V counter is used :
Disregard this figure .

TILT SWITCH

It is your option to have a TILT SWITCH in the machine. TEST lead (pin # U) could be connected to a TILT SWITCH as figured at right.

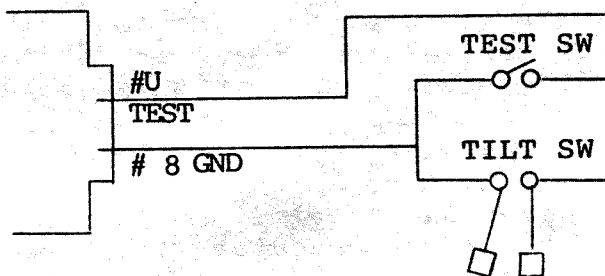

Nichibutsu

* DANGAR *

WIRING CONNECTOR

SOLDER SIDE			PARTS SIDE		
A	p1-UP	w/brown	1	p1 - DOWN	w/red
B	p1 - LEFT	w/orange	2	p1 - RIGHT	w/yel
C	p1- SHOOT	w/green	3	p1 - TRANSFORM	w/blu
D	p2 - UP		4	p2 - DOWN	
E	p2 - LEFT		5	p2 - RIGHT	
F	p2 - SHOOT		6	p2 - TRANSFORM	
H	COIN 1	w/purple	7	COIN 2	
J	GND		8	GND	black
K	GND	black	9	GND	
L	+ 5 V	red	10	+ 5 V	red
M	+ 12 V	yellow	11		
N			12	+ 12 V	
P	+ 5 V	red	13	+ 5 V	
R	GND	black	14	GND	
S	GND	black	15	GND	
T	1 player	brown	16	2 players	violet
U	TEST/Tilt	orange	17	SERVICE	w/blk
V	COUNTER 1	w/gray	18	COUNTER 2	
W	SP (+)	w/blue	19	SP (-)	gray
X			20	RED	
Y	GREEN		21	BLUE	
Z	GND	black	22	SYNC	white

Note : pin # 4-6 should be NO CONNECTION in upright

KIT CONTENTS :

- | | |
|-------------------------------------|------|
| 1. NICHIBUTSU PRINTED CIRCUIT BOARD | 1 pc |
| 2. FCC STICKER | 1 |
| 3. MARQUEE | 1 |
| 4. PLEXI GLASS | 2 |
| 5. WIRING HARNESS | 1 |
| 6. 8-WAY JOYSTICK | 1 |
| 7. BUTTON / SWITCH ASSEMBLY | 4 |
| 8. CONTROL PANEL OVERLAY | 1 |
| 9. SERVICE INSTRUCTION | 1 |

Nichibutsu

* DANGAR *

DIP SWITCH ADJUSTMENTS

SWITCH 1

		1	2	3	4	5	6	7	8
Number of player	3	OFF	OFF						
	4	ON	OFF						
	5	OFF	ON						
	6	ON	ON						
Bonus	20K & every 60K			OFF	OFF				
	20K & every 90K			OFF	ON				
	50K & every 60K			ON	OFF				
	50K & every 90K			ON	ON				
Demo Sound	WITH					OFF			
	WITHOUT					ON			
Type	TABLE						OFF		
	UPRIGHT						ON		

* : Recommended Setting

SWITCH 2

		1	2	3	4	5	6	7	8
COIN	: 1 Coin 1 Credit	OFF	OFF						
	: 1 " 2 "	ON	OFF						
	1 : 2 " 1 "	OFF	ON						
	: FREE PLAY	ON	ON						
Coin	: 1 Coin 1 Credit			OFF	OFF				
	: 1 " 2 "			ON	OFF				
	2 : 2 " 1 "			OFF	ON				
	: 2 " 3 "			ON	ON				
Difficulty	EASY					OFF			
	HARD					ON			
Screen Inversion							ON		
Continue	NONE						OFF	OFF	
	3 Times						ON	OFF	
	5 Times						OFF	ON	
	99 Times						ON	ON	

TEST MODE

Connect TEST lead from edge connector (pin # U) to a toggle switch .
When TEST SW ON , the screen will display as shown .

***** ADJUSTMENTS *****
Game adjustments are made with DIP SWITCH bank 1 and bank 2 on the CPU board. It is recommended to increase BONUS level each step after several weeks on the same location.

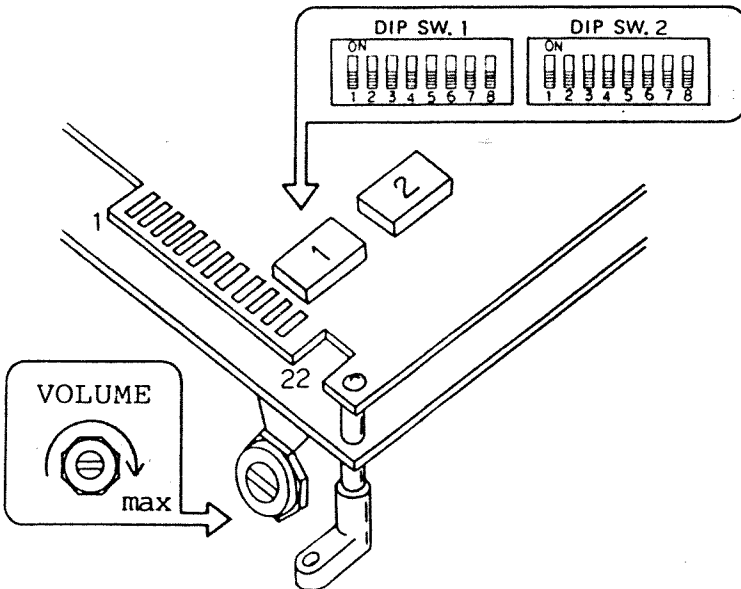
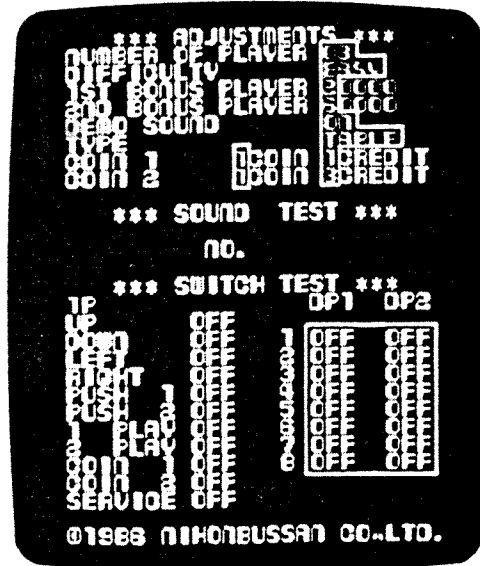

***** SOUND TEST *****
Move joystick UP & DOWN , listen for the music, adjust the volume located below edge connector.

***** SWITCH TEST *****
Shows all the functions of joystick , buttons and DIP SWITCHES.
Any CLOSED SWITCH will be indicated in RED as ON on the screen.

PUSH 1 is SHOOT button
PUSH 2 is TRANSFORM button

CONTROL PANEL

1. Remove control panel buttons and joysticks . Clean and sand old vinyl or remove old vinyl and clean with thinner.
2. Drill the holes as needed and file the new holes smooth .
3. Peel off the backing paper from our new overlay and expose the adhesive. Heating of the overlay adhesive and/or your control panel recommended in this procedure. Carefully place the overlay on top of your control panel . Try not to leave any bubbles under the overlay.
4. Use a razor knife to cut holes for buttons & joysticks . To avoid cutting a wrong hole , mark it before cut .
5. STICKERS of FIRE and TRANSFORM :
 - a. could be stuck on control panel , then put a plexi glass on top .
 - b. could be stuck under the monitor glass at bottom to be corresponding to the buttons .
6. Stick the PLAY INSTRUCTION CARD under your monitor glass .

Important note :

DANGAR will not work properly with some wide-gap leafswitch joystick .

A new joystick - made by CONTROL MARKETING - is included in this Kit for faster response desirable for the game. To avoid dull control which only frustrates players, replace your joystick with included joystick when converting to DANGAR .

MARQUEE HEADER

A lexan marquee with adhesive on the back and a clear plexi glass are provided. You can either:

1. Expose the adhesive and place it on the plexi glass so the lexan part will be on outside .
2. Put Super Glue on 4 corners of lexan and place it facedown on plexi so the lexan part will be inside . Peel off the back paper if you want to light up the DANGAR Marquee .

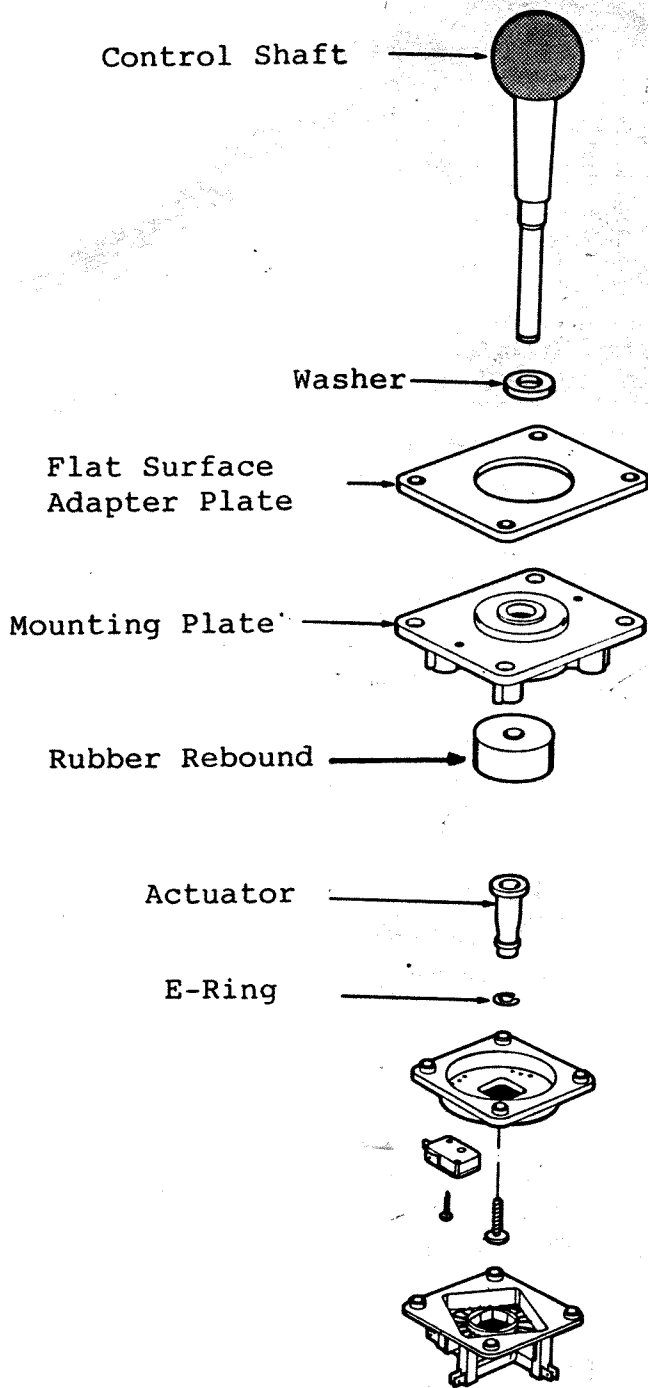

CONTROL
MARKETING Joystick # 50-4508

- To remove control shaft :
1. First remove E-Ring .
 2. Then pull control shaft out of Mounting Plate .

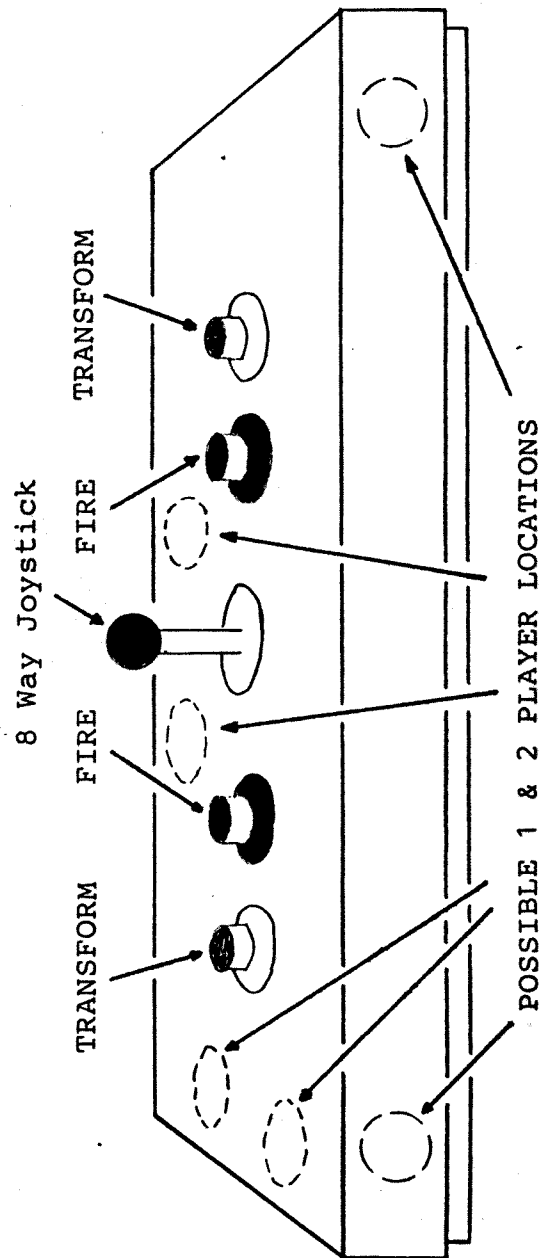

MONITOR

The P.C.Board in this kit can be used with :
 - Any VERTICALLY mounted Raster Scan Monitor .
 - Negative Composite SYNC (synchronization) .

Wires of the new harness to the monitor are color coded to indicate as:
 RED , BLUE , GREEN video signals to the monitor .
 BLACK is used for GROUND (0 V)
 WHITE is for NEGATIVE SYNC .

Attach the wires from the P.C.Board to the monitor's main circuit board as shown below .

*for WELLS-GARDNER MONITOR
 &
 *for ELECTROHOME MONITOR

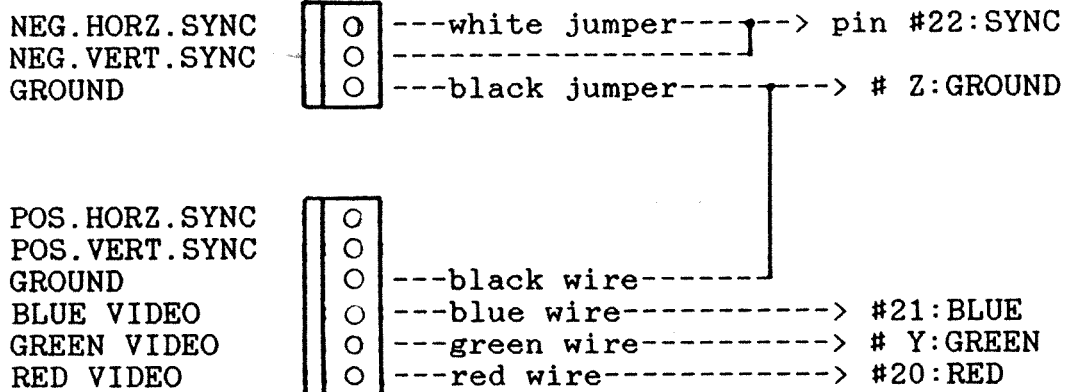

TROUBLE SHOOTING

1. NO SOUND & NO PICTURE
 - * Check +5 Volts at pin #10 (plus) and pin #15 (minus) with a voltmeter.
 - * Check voltage supply for monitor AC 100 or 120 Volts.
 - * Put Credit and push 1 PLAYER, start the game and check if you get sound or not.
2. WITH GAME MUSIC but NO PICTURE
 - * The problem could be your MONITOR.
 - * Check 5 wires : RED,BLUE,GREEN,SYNC and monitor GND.
 - * Check AC voltage supply for monitor.
 - * Replace monitor if necessary.
3. WITH PICTURE but NO SOUND
 - * Check two wires lead to SPEAKER (pin #19 and #U).
 - * Make sure both SP(+) and SP(-) are isolated from GND.
 - * Check +12 Volts at pin #12.
4. GARBAGE SCREEN DISPLAYED
 - * Adjust POWER SUPPLY to have just +5 Volts at pin #10.
 - * Check if any E-PROM chips are loose from the socket.
5. PICTURE SCROLL
 - * Recheck connections of SYNC and GND between MONITOR and edge CONNECTOR.
 - * Change SYNC polarity on your monitor POSITIVE to NEGATIVE.
6. PICTURE UP-SIDE-DOWN
 - * Switch #6 of BANK 2 will inverse the screen .

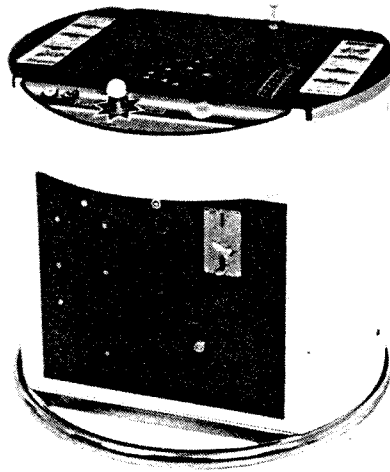

Nichibutsu

日本物産株式会社

本 社 大阪市北区天神橋1丁目12番9号 ☎(06)353-5211(代) 〒530
ファミコン インフォメーション FAX.(06)356-1531
☎(06)351-3841
HEAD OFFICE 12-9, 1-chome, Tenjinbashi, Kita-ku, Osaka Japan TELE X 523-6891 NCBCOL J
東京事務所 東京都中央区日本橋蛸留町1丁目5番12号 ヤシマ日本橋ビル ☎(03)664-5271(代) 〒103
FAX.(03)661-1326
(株)ニチブツ札幌 札幌市豊平区中の島1条7丁目1-1 京王もなみマンション ☎(011)824-2571(代) 〒062
FAX.(011)824-2584
(株)ニチブツ九州 福岡市博多区博多駅南4-4-17 新常盤ビル1F ☎(092)472-7221(代) 〒812
FAX.(092)472-7222
Nichibutsu U.S.A. Corp. 15737 S. Garfield Ave. Unit 18, Paramount, Calif. 90723, U.S.A. ☎(213)408-0515 FAX.(213)408-0208

Nichibutsu U.S.A. Corp.
15737 Garfield Ave.
Unit #18
Paramount, CA 90723

SERVICE : (213) 408-0518