

Find-It-In-Front: Dr. Pinball Section

The inside cover & the front pages
DR. ① thru DR. ⑩ covers the basics...

Find the answers to your questions here...
If you still need help, give us a call!



THIS PINBALL GAME IS
TOPS
TOURNAMENT PINBALL
SYSTEM READY!

Order the optional TOPS™ Kit
Kit Sp. P/N: 502-5011-00

DR. DR. DR.

NO YES END PREV QUIT

The Portals™ Service Menu,
Section 3, is your Technical Friend...



© MMIII New Line Productions, Inc. All Rights Reserved. The Lord of the Rings, The Fellowship of the Ring, The Two Towers & The Return of the King and the names of the characters, items, events and places therein are trademarks of The Saul Zaentz Company d / b / a Tolkien Enterprises under license to New Line Productions, Inc., an AOL Time Warner Company.

Joe Blackwell
DIRECTOR,
Parts Sales &
Technical Support

Susan White
Parts
Sales
MANAGER

Patty Schraps
Parts
Stockroom
MANAGER

Your Parts Sales & Technical Support Team

Chas Siddiqi
Technical
Support
ENGINEER

Patrick Powers
Technical
Support
ENGINEER

J. Alfer
Technical Support
Documentation
ADMINISTRATOR

Please call us at 1-800-542-5377 or
1-800-KICKERS for Technical Support.

Visit us at our Web Site www.SternPinball.com.

Stern® Pinball, Inc.
All Rights Reserved. Printed in the U.S.A.
December 2003

SPI Part Number
780-5080-00

For Proper Operation of Pinball Game,
four (4) Pinballs must be installed!



Diverter Gate Adjustment Procedure

This adjustment procedure is important. Unlike adjusting your flipper bats, adjusting the gate is done opposite. With the **Power Turned OFF** and the **Playfield raised**, at rest against the **Backbox**, perform the following:

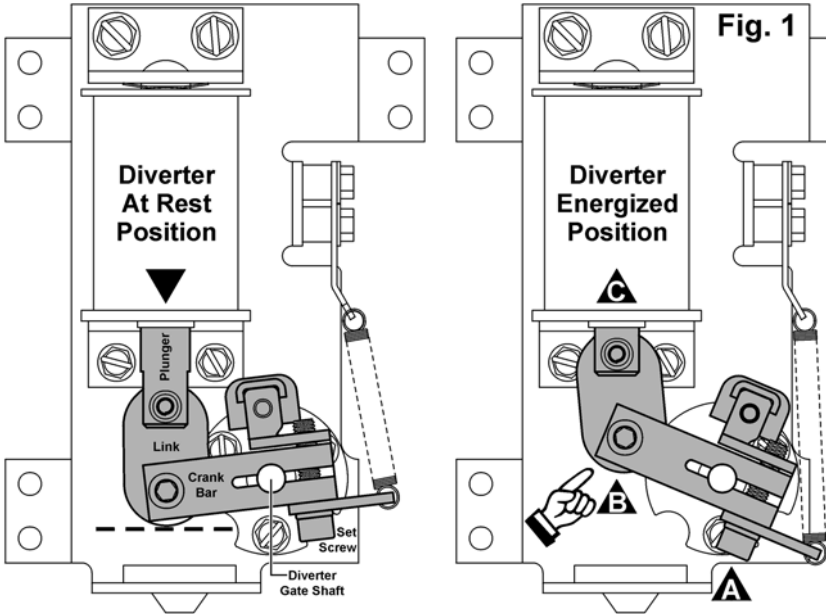

Step 1: Under the Playfield, using a 5/32" Allen Wrench, loosen the Set-Screw on the Crank Bar just enough so that the Diverter Paddle can move with a gentle amount of force. **Ref. Fig. 1-A.**

Step 2: Above the Playfield, position the Diverter Paddle to the Right Side Flat Rail so they touch (opening the gate to the Left Orthanc Tower). **Ref. Fig. 2.** With your finger, hold the gate in this position until Step 3 is performed.

Step 3: Under the Playfield, push the Diverter Coil Plunger into the Coil Sleeve. **Reference Fig. 1-B.** With your finger, continue holding in the plunger and release the Diverter Gate (Fig. 2) to perform Step 4. If the Gate moves, refer to Step 1 and retighten just enough to hold in position (Fig. 2).

Step 4: Tighten the Set-Screw on the Crank Bar. **Reference Fig. 1-A.**

Step 5: Check above the playfield to ensure the Diverter Paddle Gate in the "Rest Position" is as close to the Left Flat Rail as possible without touching it. **Reference Fig. 3.**

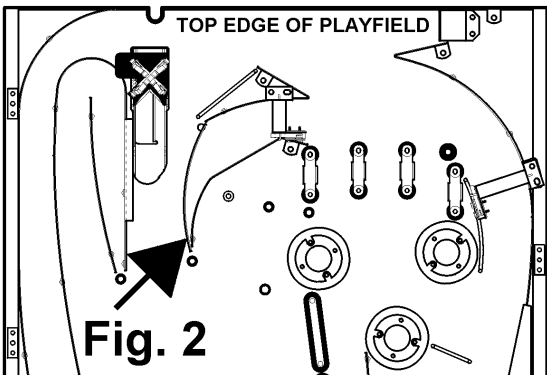

For parts, see the **Blue Pages**, Sec. 4, Chp. 2, Drawings ..., Page 80.

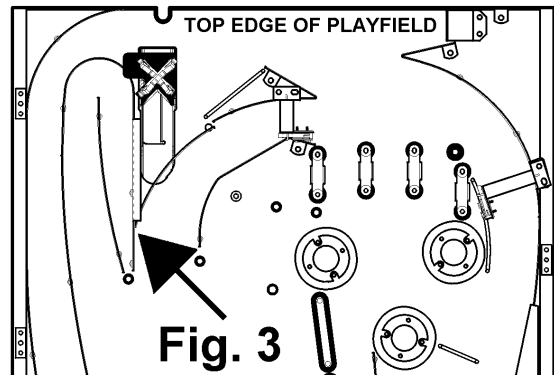

Look over the **TOURNAMENT MENU** in **Portals™!**
Read over Section 3, Chapter 7, Pages **53-57**.



An **Optional Tournament Kit** is required for this **ToPS™ Ready Pinball Game**.
You can now easily set-up, start and end Tournaments for cash, tokens, tickets or points!



New to our Pinball Games?

Don't forget to go over **Section 3, Chapter 1, Portals™ Service Menu Introduction**. If using **Diagnostics...very useful!** Got confused? Comments? Questions? Call Technical Support at 800-542-5377 or 708-345-7700 (Option 1).

Backbox PCB Fuses, ROMs, Bridges, Relays, P/F & Cabinet Fuses, Cab. Switches

CAUTION: For continued protection against risk of fire, replace only with same type of fuse having the same electrical rating!

QUICK REFERENCE FUSE CHART

Backbox Fuses

LOC: DISPLAY POWER SUPPLY (P.S.) BOARD

F1 3/4A 250v S.B. 90v DC High Voltage Display

LOC: I / O POWER DRIVER BOARD

F6 7A 250v S.B. 50v DC Primary High Power Coils/Flippers

F7 5A 250v S.B. 20v DC Low Power Coils

F8 5A 250v S.B. 12v DC Logic Power

F9 5A 250v S.B. 12v DC Logic Power

F20 4A 250v S.B. 50v DC Magnet ◀◀◀ THIS GAME ONLY

F21 3A 250v S.B. 50v DC Coils

F22 8A 250v S.B. 18v DC Controlled Lamps

F23 4A 250v S.B. 5v DC Logic

F24 5A 250v S.B. 6.3v AC G.I. Lamps (BRN-WHT to WHT-BRN)

F25 5A 250v S.B. 6.3v AC G.I. Lamps (YEL to WHT-YEL)

F26 5A 250v S.B. 6.3v AC G.I. Lamps (GRN to WHT-GRN)

F27 5A 250v S.B. 6.3v AC G.I. Lamps (VIO to WHT-VIO)

F28 3A 250v S.B. 24v AC Not Used / Spare

Cabinet Fuses

LOC: SERVICE (AC) OUTLET BOX (Cabinet Bottom)

n/a 8A 250v S.B. 115v AC Main Fuse Line (Domestic or USA)

n/a 5A 250v S.B. 220v AC Main Fuse Line (International)

Playfield (P/F) Fuses

LOC: UNDER PLAYFIELD (near Flippers)

n/a 3A 250v S.B. 50v DC Right Flipper (BLU-YEL↔RED-YEL)

n/a 3A 250v S.B. 50v DC Left Flipper (GRY-YEL↔RED-YEL)

n/a 3A 250v S.B. 50v DC Loop Diverter (GRY-YEL↔YEL-VIO)

For locations & more information on fuses, see Sec. 5, Chapter 2.

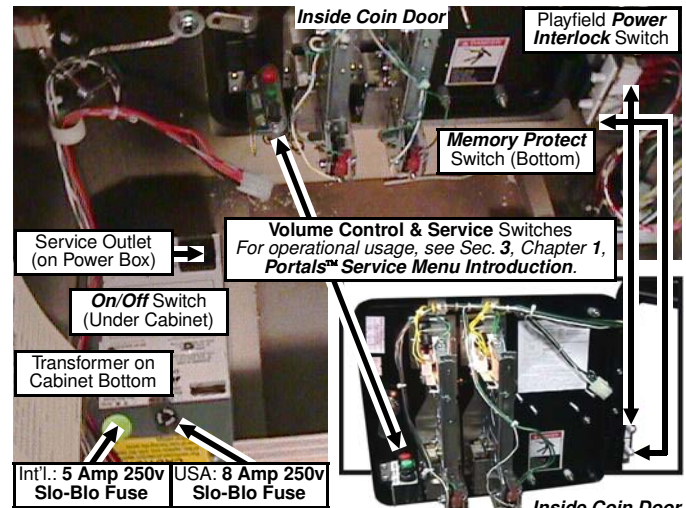

ROM TYPE on BD	LOCATION	SIZE	PART NUMBER
CPU Sound	U7	512K	965-0401-80
CPU Game	U210	1 MB	965-0402-80
CPU Voice ROM 1	U17	8 MB	965-0403-80
CPU Voice ROM 2	U21	8 MB	965-0404-80
CPU Voice ROM 3	U36	8 MB	965-0405-80
CPU Voice ROM 4	U37	8 MB	965-0406-80
DISPLAY Controller	U5	4 MB	965-0407-80

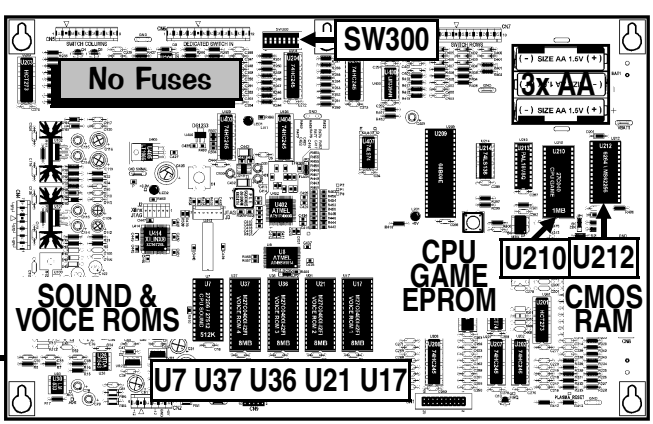

For Schematics and/or Component Parts on PC Boards shown on this page, review Section 5, Chapter 4, Printed Circuit Boards (The Yellow Pages).

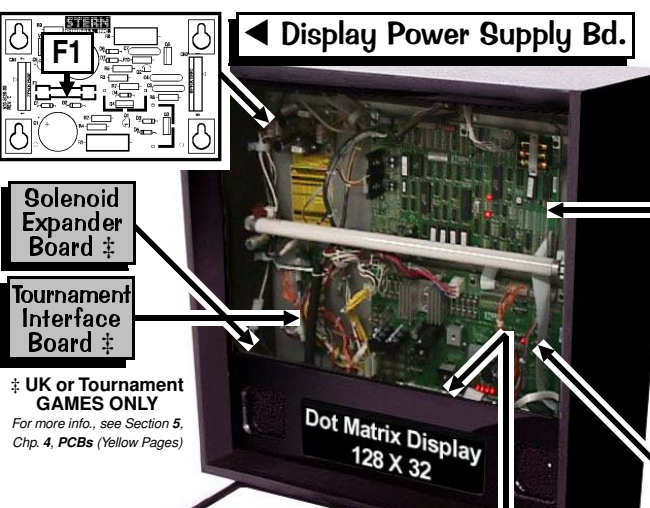

Display Controller Bd.

The Display Controller has the Display EPROM (Location: U5 / ROM 0). This board is located behind the 128 X 32 Dot Matrix Display Board.

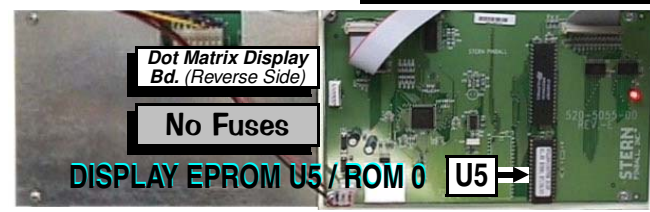

I/O Power Driver Board

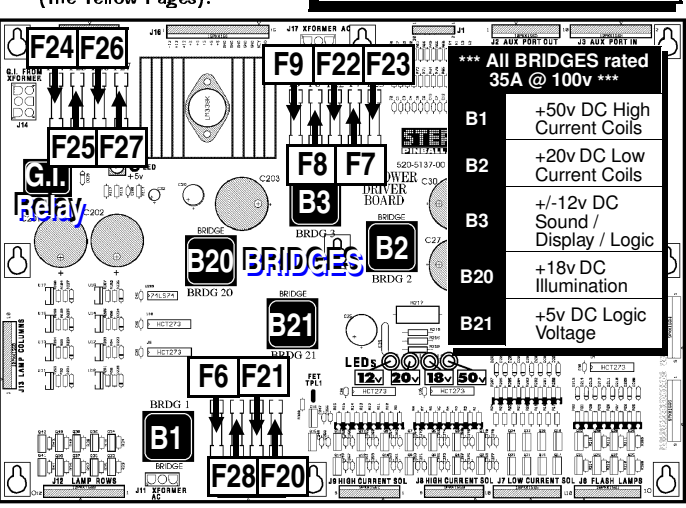

Find-It-In-Front:
Dr. Pinball

THE LORD OF THE RINGS

////// FIND-IT-IN-FRONT: Dr. Pinball Section Explained ////

The key technical data from various parts of the manual were extracted and combined into the "Find- It-In-Front: Dr. Pinball Section." This section (pages DR. ① - ⑩) will assist the technician in locating important technical information needed to troubleshoot the Pinball Machine. **Dr. Pinball** is also available in a Flow Chart Help Format in the Game Display. To access, enter the **Portals™ Service Menu**.

////// How It Works ////

First, the operator / technician must enter the **Service Menu Mode** (for a complete description of the **Portals™ Service Menu and ICONS Read! Section 3, Chapter 1**). To get into the **Service Menu Mode**, power-up the game (if not already) and open the **Coin Door**. On the **Coin Door** is the **Portals™ Service Switch Set** (Red, Green & Black Buttons).

Step 1: Push down the **Black "BEGIN TEST" Button**. Looking at the Video Display you will momentarily see the introductory screen followed by the **MAIN MENU**.

Step 2: Move through the Menus by pushing the **Red "LEFT"** or **Green "RIGHT"** Buttons.



Step 3: Select or activate the *Icons* by pushing the **Black "ENTER" Button**.

While in the **Portals™ Service Menu**, the **Start Button** can be used in lieu of the **Black Button**; the **Left & Right Flipper Buttons** can be used in lieu of the **Red & Green Buttons**. However, in *Switch or Active Switch Tests* **only** the **Red & Green Buttons** can be used.



In our **Portals™ Service Menu**, selecting the "DR." *Icon* will bring the operator/technician into **DR. PINBALL** (Flow Chart Menus), the "on-screen" diagnostic aide. This is a feature that will allow you to utilize the power of the micro-processor assisting in troubleshooting a problem with the machine in a **Flow Chart** format (follow the questions & answer by using the *Mini-Icons* in the display).



After entering **Portals™**, the **MAIN MENU** now appears with the "DIAG" *Icon* (GO TO DIAGNOSTICS MENU) flashing; press the **Black "ENTER" Button** to activate this **ICON**. The **DIAGNOSTICS MENU** now appears with the "SW" *Icon* (GO TO SWITCH MENU) flashing; use the **Red "LEFT"** or **Green "RIGHT"** Buttons, until the "DR." *Icon* (DR. PINBALL) is flashing:



Press the **Black "ENTER" Button** to activate this **ICON**. The **DR. PINBALL MENU** (Flow Chart Menus) now appears with the **COIL "DR." Icon** flashing. Three (3) *Icons*, **Coil "DR."**, **Switch "DR."** and **Lamp "DR."** are available for selection. Selecting a particular *Icon* will give you a choice of which specific **Coil** (any and all coil assemblies such as *Flippers, VUKs, Magnets, etc.*), **Switch** or **Lamp Circuit** needs to be diagnosed. After selection, **Dr. Pinball** will now display a question or a procedure to follow such as "Does the lamp turn on?" or "Check bridge rectifier BR-20, if short replace." When **Dr. Pinball** displays a question or requests a procedure, **Dr. Pinball** will expect a response such as "NO" or "YES". You the operator/technician must respond by using the **Red** or **Green Buttons** to "SELECT" a *Mini-Icon* and the **Black Button** to "ACTIVATE or ENTER" your selection.



For *Mini-Icons* explanations & details, see the end of **Section 3, Chapter 2, GO TO DIAGNOSTICS MENU, Dr. Pinball**.

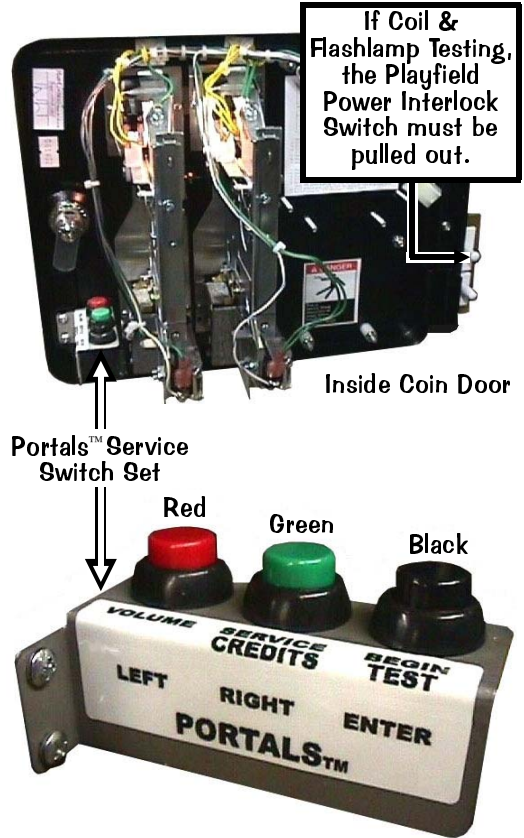

DIAGNOSTIC AIDS

OPEN THE DOOR

If this **display flashes**, the game is indicating that **CMOS RAM** memory (*CPU Loc. U212*) has been corrupted. This is caused by either failure in memory (*e.g. batteries are dead and/or faulty RAM*) or upon installation of updated version of game code. Opening the **Coin Door** will initiate a **Factory Restore (Reset)**, by opening the **Memory Protect Switch**. Check battery voltage at **VBATT Test Point** on the **CPU/Sound Bd.** (*more details in Section 5, Chapter 4, PCBs*).

OPERATOR ALERT! #2 AUTO LAUNCH COIL MALFUNCTION

This **display** is shown momentarily during **Game Mode** or **Power-Up** to alert the operator of a coil malfunction (*coil doesn't energize or coil fires a multiple number of times*). **OPERATOR ALERT!** works by monitoring any **switch activated coil** that has the potential to trap a ball when disabled (*e.g. in the Auto Launch, Scoop, Eject, etc.*). This alert can also appear if a switch associated with a coil (*e.g. #16 Shooter Lane & #2 Auto Launch*) is stuck closed (*caused by a switch jam or stuck ball*); the **CPU/Sound Board** will activate the coil approximately ten times and if the switch remains closed, the game will report this switch in **Technician Alerts** & will indicate the *following display warning*:

PLEASE CHECK TECH REPORT PORTALS->DIAG->TECH

If this **Tech Report Alert flashes** (*along with an audible sound*), the game has detected faulty switches and/or missing pinballs. Select the "TECH" *Icon* for information (*review Technician Alerts, Pages 24-25*). For this **Alert display** to appear, *Standard Adj. 49, must be changed to POWERUP, COIN DOOR or POWERUP AND COIN DOOR, the default is NEVER* (*review Section 3, Chp. 4, GO TO ADJUSTMENTS MENU, Standard Adjustments, Page 44*).

CPU DIP SWITCH SETTINGS

Location of Dip Switch [SW300] is on the CPU/Sound Board (Right of CN6, Top Middle)

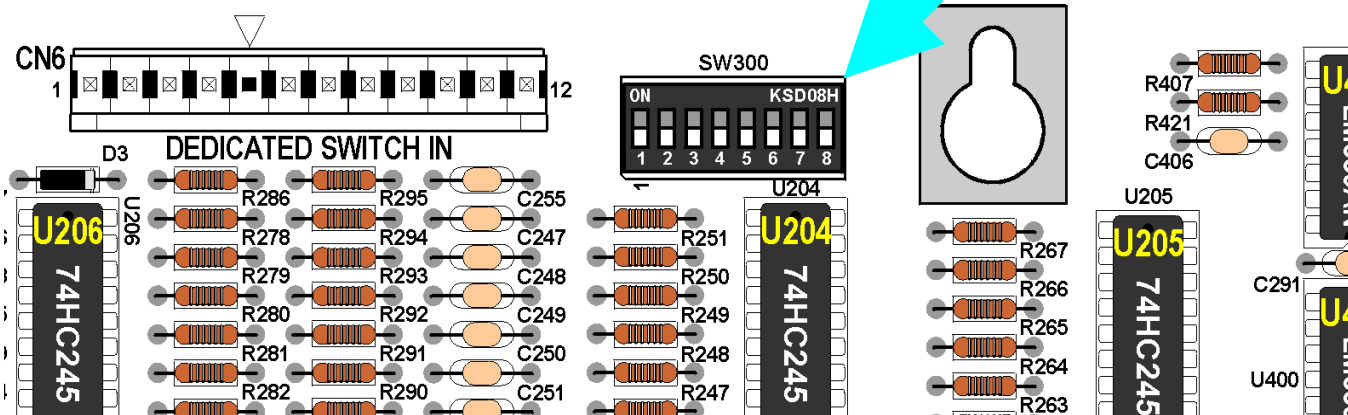

CPU COUNTRY SETTING:		Pos.	1	2	3	4	5	6	7	8
USA	ON		▲	▲	▲	▲	▲	▲	▲	▲
	OFF	▼	▼	▼	▼	▼	▼	▼	▼	▼
Austria	ON	▲	▲	▲	▲	▲	▲	▲	▲	▲
	OFF	▼	▼	▼	▼	▼	▼	▼	▼	▼
Australia	ON	▲	▲	▲	▲	▲	▲	▲	▲	▲
	OFF	▼	▼	▼	▼	▼	▼	▼	▼	▼
Belgium	ON	▲	▲	▲	▲	▲	▲	▲	▲	▲
	OFF	▼	▼	▼	▼	▼	▼	▼	▼	▼
Canada	ON	▲	▲	▲	▲	▲	▲	▲	▲	▲
	OFF	▼	▼	▼	▼	▼	▼	▼	▼	▼
Denmark	ON	▲	▲	▲	▲	▲	▲	▲	▲	▲
	OFF	▼	▼	▼	▼	▼	▼	▼	▼	▼
Finland	ON	▲	▲	▲	▲	▲	▲	▲	▲	▲
	OFF	▼	▼	▼	▼	▼	▼	▼	▼	▼
France	ON	▲	▲	▲	▲	▲	▲	▲	▲	▲
	OFF	▼	▼	▼	▼	▼	▼	▼	▼	▼
Germany	ON	▲	▲	▲	▲	▲	▲	▲	▲	▲
	OFF	▼	▼	▼	▼	▼	▼	▼	▼	▼
Greece	ON	▲	▲	▲	▲	▲	▲	▲	▲	▲
	OFF	▼	▼	▼	▼	▼	▼	▼	▼	▼
Italy	ON	▲	▲	▲	▲	▲	▲	▲	▲	▲
	OFF	▼	▼	▼	▼	▼	▼	▼	▼	▼
Netherlands	ON	▲	▲	▲	▲	▲	▲	▲	▲	▲
	OFF	▼	▼	▼	▼	▼	▼	▼	▼	▼
New Zealand	ON	▲	▲	▲	▲	▲	▲	▲	▲	▲
	OFF	▼	▼	▼	▼	▼	▼	▼	▼	▼
Norway	ON	▲	▲	▲	▲	▲	▲	▲	▲	▲
	OFF	▼	▼	▼	▼	▼	▼	▼	▼	▼
Portugal	ON	▲	▲	▲	▲	▲	▲	▲	▲	▲
	OFF	▼	▼	▼	▼	▼	▼	▼	▼	▼
Spain	ON	▲	▲	▲	▲	▲	▲	▲	▲	▲
	OFF	▼	▼	▼	▼	▼	▼	▼	▼	▼
Sweden	ON	▲	▲	▲	▲	▲	▲	▲	▲	▲
	OFF	▼	▼	▼	▼	▼	▼	▼	▼	▼
Switzerland	ON	▲	▲	▲	▲	▲	▲	▲	▲	▲
	OFF	▼	▼	▼	▼	▼	▼	▼	▼	▼
UK	ON	▲	▲	▲	▲	▲	▲	▲	▲	▲
	OFF	▼	▼	▼	▼	▼	▼	▼	▼	▼



Find-It-In-Front:
Dr. Pinball

THE LORD OF THE RINGS



In SWITCH MENU also select:

ACTIVE and DEDICATED SWITCH TESTS

SWITCH MATRIX GRID, DEDICATED SWITCHES & LOCATIONS

Column (Drive)	1: Q1	2: Q2	3: Q3	4: Q4	5: Q5	6: Q6	7: Q7	8: Q8	GROUND	GROUND
Row (Return)	GRN-BRN CN5-P1	GRN-RED CN5-P3	GRN-ORG CN5-P4	GRN-YEL CN5-P5	GRN-BLK CN5-P6	GRN-BLU CN5-P7	GRN-VIO CN5-P8	GRN-GRY CN5-P9	IC U206 INPUTS	BLK CN6-P1, -P11
1: U400	1 Cabinet Side WHT-BRN CN7-P9 LT BUTTON (UK ONLY) Sw. Part Number: 180-5160-00	9 Below P/F LEFT VUK Sw. Part Number: 180-5116-01	17 Above P/F SWORD LOCK HIGH Sw. Part Number: 180-5119-02	25 Above P/F RIGHT RAMP ENTER Sw. Part Number: 180-5010-01	33 Mini-P/F MINI PF U.L. Sw. Part Number: 180-5057-00	41 Below P/F TOP VUK See Sw. 41 Note	49 Below P/F LEFT BUMPER Sw. Part Number: 180-5015-03	57 Below P/F LEFT OUTLANE Sw. Part Number: 500-6227-02	1: U206 GRY-BRN CN6-P2 Sw. Part Number: 180-5160-00	DS-1 on Cabinet Side #1 LEFT FLIPPER BUTTON
2: U400	2 Coin Door 4TH COIN SLOT Sw. Part Number: 180-5204-00	10 Below P/F STANDUP Sw. Part Number: 515-6027-08	18 Above P/F SWORD LOCK MID Sw. Part Number: 180-5119-02	26 NOT USED	34 Mini-P/F MINI PF U.R. Sw. Part Number: 180-5057-00	42 Above P/F INNER LOOP Sw. Part Number: 180-5190-28	50 Below P/F RIGHT BUMPER Sw. Part Number: 180-5015-03	58 Below P/F LEFT RETURN LANE Sw. Part Number: 500-6227-02	2: U206 GRY-RED CN6-P3 Sw. Part Number: 180-5149-00 on Flipper	DS-2 Below Playfield #2 LEFT FLIPPER E.O.S (End-of-Stroke)
3: U400	3 Coin Door 6TH COIN SLOT Sw. Part Number: Future Use	11 Below P/F 4-BALL TROUGH #1 (LEFT) Sw. Part Number: 180-5119-02	19 Above P/F SWORD LOCK LOW Sw. Part Number: 180-5119-02	27 NOT USED	35 Mini-P/F MINI PF L.L. Sw. Part Number: 180-5057-00	43 Below P/F LEFT TOP LANE Sw. Part Number: 500-6227-02	51 Below P/F BOTTOM BUMPER Sw. Part Number: 180-5015-03	59 Below P/F LEFT SLINGSHOT (x2) Sw. Part Number: 180-5054-00	3: U206 GRY-ORG CN6-P4 Sw. Part Number: 180-5160-00	DS-3 on Cabinet Side #3 RIGHT FLIPPER BUTTON
4: U400	4 Coin Door RIGHT COIN SLOT Sw. Part Number: 180-5204-00	12 Below P/F 4-BALL TROUGH #2 Sw. Part Number: 180-5119-02	20 Below P/F RIGHT ORBIT LOW Sw. Part Number: 500-6227-02	28 Above P/F BALROG HIT Sw. Part Number: 180-5119-00	36 Mini-P/F MINI PF L.R. Sw. Part Number: 180-5057-00	44 Below P/F MIDDLE TOP LANE Sw. Part Number: 500-6227-02	52 Above P/F SPINNER Sw. Part Number: 180-5190-28	60 Below P/F RIGHT OUTLANE Sw. Part Number: 500-6227-02	4: U206 GRY-YEL CN6-P6 Sw. Part Number: 180-5149-00 on Flipper	DS-4 Below Playfield #4 RIGHT FLIPPER E.O.S (End-of-Stroke)
5: U401	5 Coin Door CENTER COIN SLOT / DBA Sw. Part Number: 180-5204-00	13 Below P/F 4-BALL TROUGH #3 Sw. Part Number: 180-5119-02	21 Above P/F RIGHT ORBIT HI Sw. Part Number: 180-5190-28	29 Below P/F PALANTIR Sw. Part Number: 515-5162-08	37 Below P/F LEFT ORBIT LOW Sw. Part Number: 500-6227-02	45 Below P/F RIGHT TOP LANE Sw. Part Number: 500-6227-02	53 Below P/F SPOT RING Sw. Part Number: 515-5162-08	61 Below P/F RIGHT RETURN LANE Sw. Part Number: 500-6227-02	5: U206 GRY-GRN CN6-P7 Sw. Part Number: 180-5160-00	DS-5 NOT USED
6: U401	6 Coin Door LEFT COIN SLOT Sw. Part Number: 180-5204-00	14 Below P/F 4-BALL TROUGH VUK OPTO See Sw. 14 Note	22 Above P/F RIGHT RAMP EXIT Sw. Part Number: 180-5197-00	30 Below P/F RIGHT VUK Sw. Part Number: 180-5116-01	38 Below P/F LEFT ORBIT HI Sw. Part Number: 500-6227-02	46 Below P/F TOP SAUCER Sw. Part Number: 180-5186-00	54 In Cabinet START BUTTON Sw. Part Number: 180-5174-00	62 Below P/F RIGHT SLINGSHOT (x2) Sw. Part Number: 180-5054-00	6: U206 GRY-BLU CN6-P8 Sw. Part Number: 180-5192-02	DS-6 on Coin Door #6 VOLUME (RED BUTTON) (In Test: LEFT)
7: U401	7 Coin Door 5TH COIN SLOT Sw. Part Number: Future Use	15 Below P/F 4-BALL STACKING OPTO See Sw. 15 Note	23 Above P/F RIGHT RAMP TARGET Sw. Part Number: 515-5027-08	31 Below P/F BALROG OPEN Sw. Part Number: 180-5119-02	39 Below P/F LEFT RAMP ENTER Sw. Part Number: 500-6227-02	47 Back Panel RING MADE See Sw. 47 Note	55 In Cabinet TOURNAMENT START Sw. Part Number: 180-5174-00	63 NOT USED	7: U206 GRY-VIO CN6-P9 Sw. Part Number: 180-5192-04	DS-7 on Coin Door #7 SERV. CRED. (GREEN BUTTON) (In Test: RIGHT)
8: U401	8 Cabinet Side RT BUTTON (UK ONLY) Sw. Part Number: 180-5160-00	16 Below P/F SHOOTER LANE Sw. Part Number: 180-5157-00	24 Above P/F RIGHT RAMP MADE Sw. Part Number: 180-5198-00	32 Below P/F BALROG CLOSED Sw. Part Number: 180-5119-02	40 Above P/F LEFT RAMP MADE Sw. Part Number: 180-5010-01	48 Back Panel BACK TROUGH Sw. Part Number: 180-5057-00	56 In Cabinet PLUMB BOB TILT See Sw. 56 Note	64 NOT USED	8: U206 GRY-BLK CN6-P10 Sw. Part Number: 180-5192-00	DS-8 on Coin Door #8 BEGIN TEST (BLACK BUTTON) (In Test: ENTER)

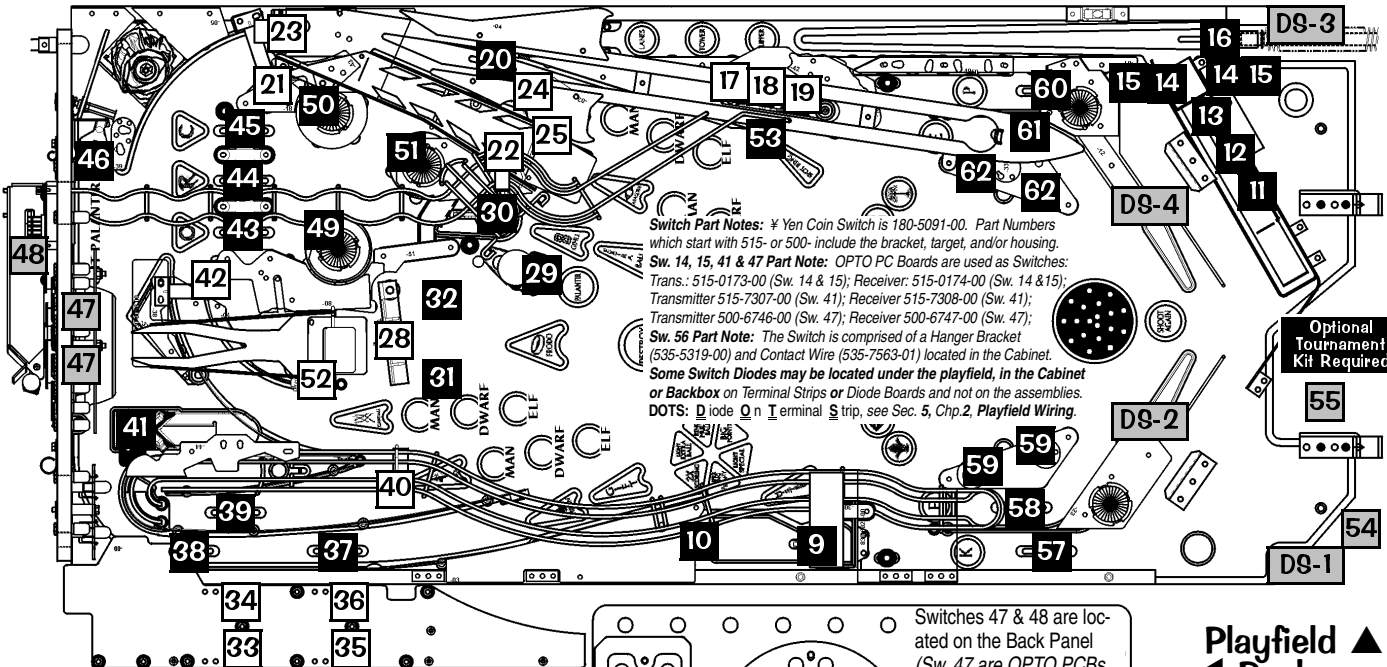

Mini-Upper Playfield ▲ shown moved off the Main Playfield for clarity.

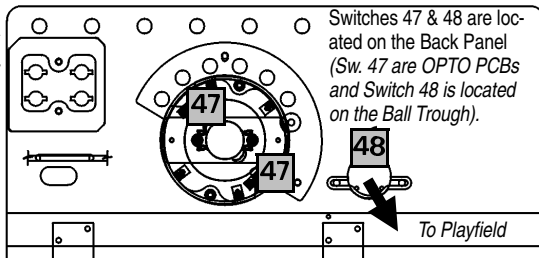

Playfield ▲
Backpanel ◀

- ◻ = Switches above P/F.
- ◼ = Switches below P/F.
- ◻◼ = Switches not on P/F.





In LAMP MENU also select:
TEST ALL LAMPS, ROW & COLUMN LAMP TESTS

LAMP MATRIX GRID & LOCATIONS

Column (18v)	1: U17	2: U16	3: U15	4: U14	5: U13	6: U12	7: U11	8: U10
Row (Ground)	YEL-BRN J13-P9	YEL-RED J13-P8	YEL-ORG J13-P7	YEL-BLK J13-P6	YEL-GRN J13-P5	YEL-BLU J13-P4	YEL-VIO J13-P3	YEL-GRY J13-P1
1: Q33	1 #555 Bulb (K) EEP	2 #555 Bulb K (E) EP	3 #555 Bulb KE (E) P	4 #555 Bulb KEE (P)	5 #555 Bulb THE FELLOWSHIP OF THE RING	6 #555 Bulb THE TWO TOWERS	7 #555 Bulb THE RETURN OF THE KING	8 #555 Bulb SHOOT AGAIN
2: Q34	9 #555 Bulb PIPPIN	10 #555 Bulb MERRY	11 #555 Bulb SAM	12 #555 Bulb ARAGORN	13 #555 Bulb FRODO	14 #555 Bulb GANDALF	15 #555 Bulb LEGOLES	16 #555 Bulb GIMLI
3: Q35	17 #555 Bulb BOROMIR	18 #555 Bulb MYSTERY	19 #555 Bulb FRODO ARROW	20 #44 Bulb DESTROY RING	21 #555 Bulb MODE START	22 #555 Bulb PALANTIR	23 #44 Bulb PALANTIR GLOBE	24 #555 Bulb SPOT RING
4: Q36	25 #555 Bulb PIPPIN ARROW	26 #555 Bulb GIFT OF THE ELVES	27 #555 Bulb LIGHT EXTRA BALL	28 #555 Bulb RING MULTIBALL	29 #555 Bulb BIG POINTS	30 #555 Bulb LIGHT SPECIAL	31 #555 Bulb SUPER RING FRENZY	32 #555 Bulb 2X SCORING
5: Q37	33 #555 Bulb LEGOLES ARROW	34 #555 Bulb L RAMP MAN RING	35 #555 Bulb L RAMP DWARF RING	36 #555 Bulb L RAMP ELF RING	37 #555 Bulb GANDALF ARROW	38 #555 Bulb C LOOP MAN RING	39 #555 Bulb C LOOP DWARF RING	40 #555 Bulb C LOOP ELF RING
6: Q38	41 #555 Bulb GIMLI ARROW	42 #555 Bulb EXTRA BALL	43 #555 Bulb GOLLUM MULTIBALL	44 #555 Bulb SPECIAL	45 #555 Bulb MERRY ARROW	46 #555 Bulb R ORBIT MAN RING	47 #555 Bulb R ORBIT DWARF RING	48 #555 Bulb R ORBIT ELF RING
7: Q39	49 #555 Bulb ARAGORN ARROW	50 #555 Bulb R RAMP MAN RING	51 #555 Bulb R RAMP DWARF RING	52 #555 Bulb R RAMP ELF RING	53 #555 Bulb LOCK	54 #555 Bulb LANES	55 #555 Bulb TOWER	56 #555 Bulb FLIPPER
8: Q40	57 #555 Bulb (O) RC	58 #555 Bulb O (R) C	59 #555 Bulb OR (C)	60 #555 Grn. Bulb POTD U.L.	61 #555 Grn. Bulb POTD U.R.	62 #555 Grn. Bulb POTD L.L.	63 #555 Grn. Bulb POTD L.R.	64 #44 Bulb SHOOTER LANE #1 BOT
9: Q41	65 #44 Bulb SHOOTER LANE #2	66 #44 Bulb SHOOTER LANE #3	67 #44 Bulb SHOOTER LANE #4	68 #44 Bulb SHOOTER LANE #5	69 #44 Bulb SHOOTER LANE #6	70 #44 Bulb SHOOTER LANE #7	71 #44 Bulb SHOOTER LANE #8	72 #44 Bulb SHOOTER LANE #9 TOP
10: Q42	73 #44 Bulb ESCAPE THE RINGWRAITHS	74 #44 Bulb GANDALF VS SARUMAN	75 #44 Bulb WARG ATTACK	76 #44 Bulb WAR OF THE ENTS	77 #44 Bulb BATTLE WITH SHELOB	78 #44 Bulb DESTROY THE WITCH-KING	79 #555 Bulb TOURNAMENT BUTTON	80 #555 Bulb START BUTTON

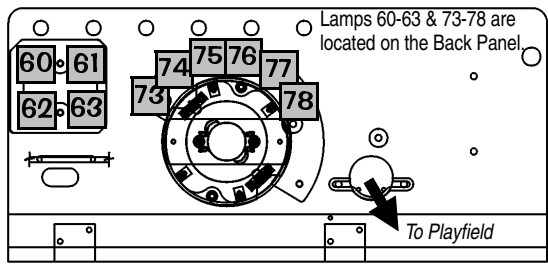
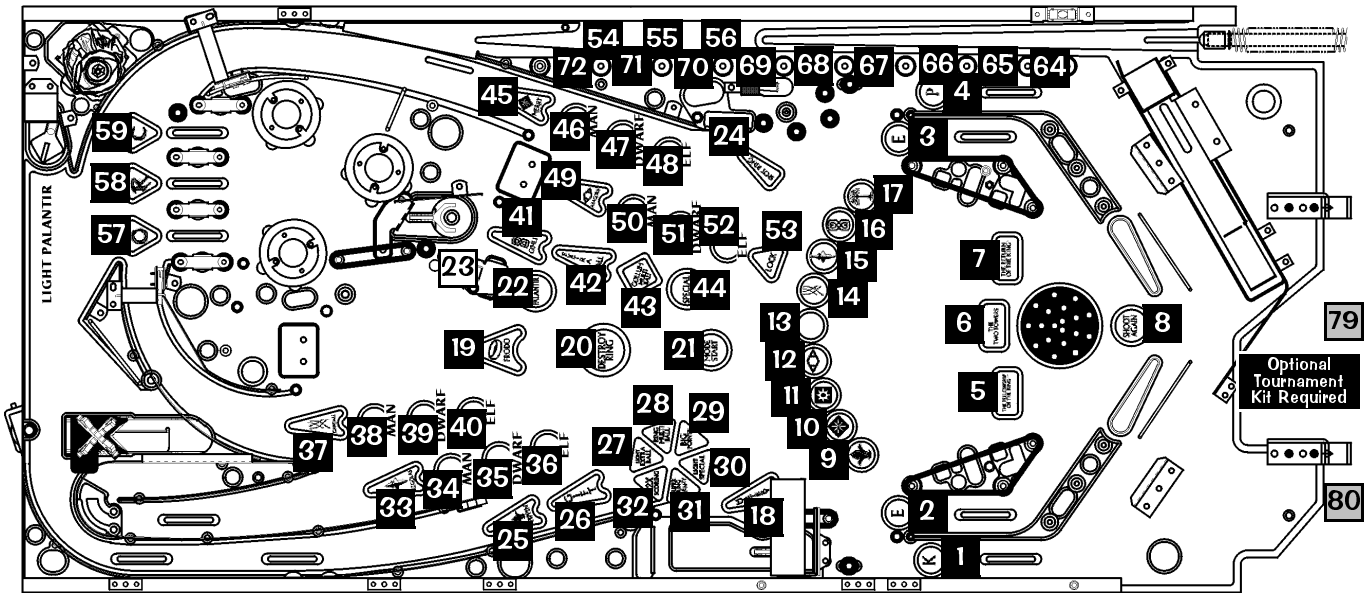

Playfield ▲
Backpanel ◀

- = Lamps above Playfield.
- = Lamps below Playfield.
- = Lamps not on Playfield.

Lamp Part Notes: #555 Bulb Clear = 165-5002-00. #555 Bulb Green = 165-5054-04. #44 Bulb Clear = 165-5000-44. See Section 4, Chapter 1, **Parts Identification & Location**, Pages 72-74 for more details on bulbs and corresponding sockets.
Some Lamp Diodes may be located under the playfield, in the Cabinet or Backbox on Terminal Strips and not on or with the Lamp Socket.
DOTS: D iode Q n I terminal Strip, see Sec. 5, Chapter 2, **Playfield Wiring**.



In COIL MENU
also select:

CYCLING
COIL
TEST

COILS DETAILED CHART TABLE

High Current Coils Group 1		Drive Transistor	Driver Output Board	Power Line Color	Power Line Connection	Power Voltage	Drive Transistor Control Line Color	D.T. Control Line Connect	Coil GA-Turn or Bulb Type
#1	TROUGH UP-KICKER	Q1	▲ I/O Power Driver ▼	YEL-VIO	J10-P4/5	50v DC	BRN-BLK	J8-P1	26-1200 ♂ 090-5044-00T
#2	AUTO LAUNCH	Q2		YEL-VIO	J10-P4/5	50v DC	BRN-RED	J8-P3	24-940 ♂ 090-5036-00T
#3	LEFT VUK	Q3		YEL-VIO	J10-P4/5	50v DC	BRN-ORG	J8-P4	26-1200 ♂ 090-5044-00B
#4	TOP VUK	Q4		YEL-VIO	J10-P4/5	50v DC	BRN-YEL	J8-P5	26-1200 ♂ 090-5044-00B
#5	RIGHT VUK	Q5		YEL-VIO	J10-P4/5	50v DC	BRN-GRN	J8-P6	26-1200 ♂ 090-5044-00B
#6	RING MAGNET	Q6		VIO-YEL	J10-P3	50v DC	BRN-BLU	J8-P7	20½-480 ♂ 090-5064-02
#7	RIGHT TOWER	Q7		YEL-VIO	J10-P4/5	50v DC	BRN-VIO	J8-P8	23-800 090-5001-NL
#8	LOOP DIVERTER	Q8		GRY-YEL-3A Fuse-YEL-VIO	J10-P1/2	50v DC	BRN-GRY	J8-P9	22-1080 ♂ 090-5032-00T

Diode On Terminal Strip (if noted)

High Current Coils Group 2		Drive Transistor	Driver Output Board	Power Line Color	Power Line Connection	Power Voltage	Drive Transistor Control Line Color	D.T. Control Line Connect	Coil GA-Turn or Bulb Type
#9	LEFT BUMPER	Q9	▲ I/O Power Driver ▼	YEL-VIO	J10-P4/5	50v DC	BLU-BRN	J9-P1	26-1200 ♂ 090-5044-00T
#10	RIGHT BUMPER	Q10		YEL-VIO	J10-P4/5	50v DC	BLU-RED	J9-P2	26-1200 ♂ 090-5044-00T
#11	BOTTOM BUMPER	Q11		YEL-VIO	J10-P4/5	50v DC	BLU-ORG	J9-P4	26-1200 ♂ 090-5044-00T
#12	NOT USED	Q12					BLU-YEL	J9-P5	
#13	ORBIT PIN	Q13		BRN	J7-P1	20v DC	BLU-GRN	J9-P6	26-1200 ♂ 090-5044-00B
#14	FLASH: HELMS DEEP RT	Q14		ORG	J6-P10	50v DC	BLU-BLK	J9-P7	#906 Bulb 165-5004-00
#15	LEFT FLIPPER (50v RED/YEL)	Q15		GRY-YEL-3A Fuse-RED-YEL	J10-P1/2	50v DC	ORG-GRY	J9-P8	22-900 ♂ 090-5020-20T
#16	RIGHT FLIPPER (50v RED/YEL)	Q16		BLU-YEL-3A Fuse-RED-YEL	J10-P1/2	50v DC	ORG-VIO	J9-P9	22-900 ♂ 090-5020-20T

Low Current Coils Group 1		Drive Transistor	Driver Output Board	Power Line Color	Power Line Connection	Power Voltage	Drive Transistor Control Line Color	D.T. Control Line Connect	Coil GA-Turn or Bulb Type
#17	LEFT SLINGSHOT	Q17	▲ I/O Power Driver ▼	BRN	J7-P1	20v DC	VIO-BRN	J7-P2	23-800 ♂ 090-5001-00T
#18	RIGHT SLINGSHOT	Q18		BRN	J7-P1	20v DC	VIO-RED	J7-P3	23-800 ♂ 090-5001-00T
#19	TOP SAUCER	Q19		BRN	J7-P1	20v DC	VIO-ORG	J7-P4	26-1200 ♂ 090-5044-00B
#20	BALROG MOTOR RELAY	Q20		BRN	J7-P1	20v DC	VIO-YEL	J7-P6	DC Relay 520-5066-00
#21	SWORD LOCK RELEASE	Q21		BRN	J7-P1	20v DC	VIO-GRN	J7-P7	27-1500 ♂ 090-5004-00T
#22	BALROG MOTOR	Q22		BRN	J7-P1	20v DC	VIO-BLU	J7-P8	Motor 041-5088-01
#23	FLASH: HELMS DEEP LT	Q23		ORG	J6-P10	20v DC	VIO-BLK	J7-P9	#906 Bulb 165-5004-00
#24	OPTIONAL COIL	Q24		RED	J16-P7	5v DC	VIO-GRY	J7-P10	Opt. 5v

Low Current Coils Group 2		Drive Transistor	Driver Output Board	Power Line Color	Power Line Connection	Power Voltage	Drive Transistor Control Line Color	D.T. Control Line Connect	Coil GA-Turn or Bulb Type
#25	FLASH: POPS X3	Q25	▲ I/O Power Driver ▼	ORG	J6-P10	20v DC	BLK-BRN	J6-P1	#906 Bulb 165-5004-00
#26	FLASH: RING	Q26		ORG	J6-P10	20v DC	BLK-RED	J6-P2	#906 Bulb 165-5004-00
#27	FLASH: BACK PANEL	Q27		ORG	J6-P10	20v DC	BLK-ORG	J6-P3	#906 Bulb 165-5004-00
#28	NOT USED	Q28					BLK-YEL	J6-P4	
#29	FLASH: RINGWRAITH	Q29		ORG	J6-P10	20v DC	BLK-GRN	J6-P5	#906 Red 165-5004-02
#30	FLASH: SWORD	Q30		ORG	J6-P10	20v DC	BLK-BLU	J6-P6	#906 Bulb 165-5004-00
#31	FLASH: DESTROY THE RING	Q31		ORG	J6-P10	20v DC	BLK-VIO	J6-P7	#89 Bulb 165-5000-89
#32	FLASH: BALROG	Q32		ORG	J6-P10	20v DC	BLK-GRY	J6-P8	#89 Bulb 165-5000-89

Note: In Test Flash Lamps Menu ("Flash" Icon), Flashers tested are all Flash Lamps located between Q1-Q32 (This Game: Q14, Q23 & Q25-Q27, Q29-Q32)

Auxiliary (UK ONLY)		Drive Transistor	Driver Output Board	Power Line Color	Power Line Connection	Power Voltage	Drive Transistor Control Line Color	D.T. Control Line Connect	Coil GA-Turn
AUX 1: LEFT UP/DOWN POST		Q1	UK 3X Trans. Driver Board	BRN	J7-P1	20v DC	WHT	J2-P3	26-1200 ♂ 090-5044-00T
AUX 2: CENTER UP/DOWN POST		Q2		BRN	J7-P1	20v DC	RED	J2-P4	23-1100 ♂ 090-5030-00T
AUX 3: RIGHT UP/DOWN POST		Q3		BRN	J7-P1	20v DC	ORG	J2-P7	26-1200 ♂ 090-5044-00T

♂ Coil Note: ♂ Either -00B or -00T can be used for coil replacements. B/T listed is preferable for easier diode access & may differ on game.



COIL & FLASH LAMP LOCATIONS

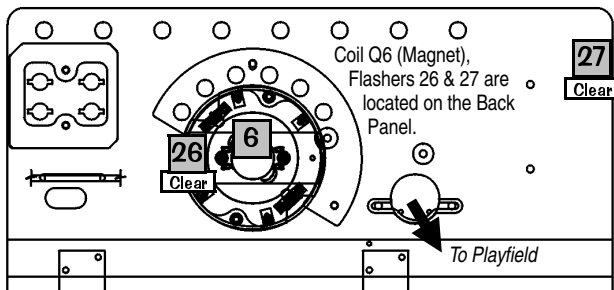

◀ Backpanel

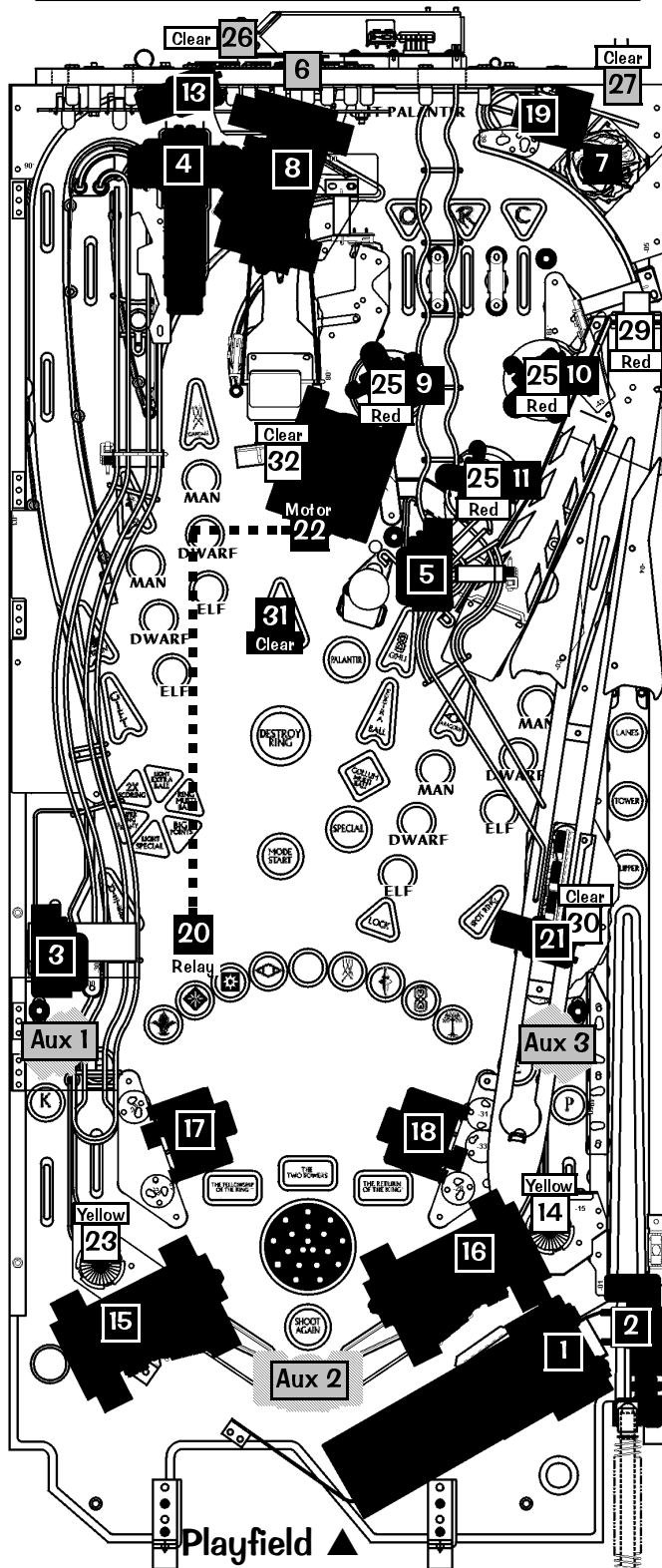

Typical Switch Wiring & Schematic

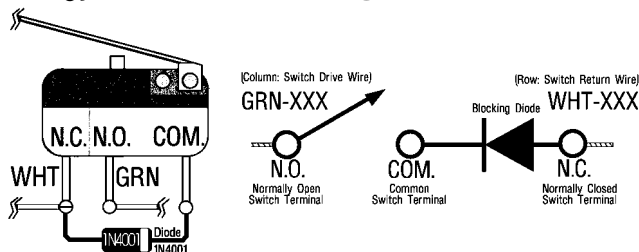

Dedicated Switch Schematic

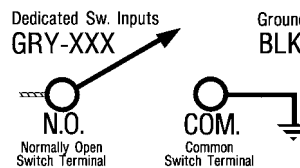

Typical Lamp Wiring & Schematic

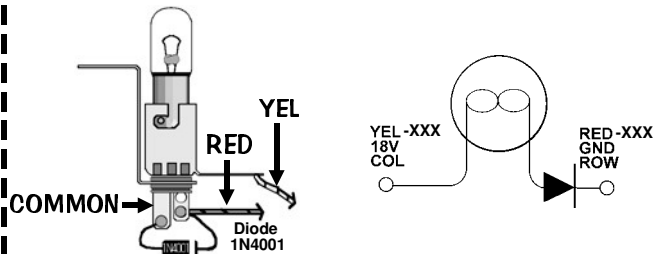

Typical Coil Wiring

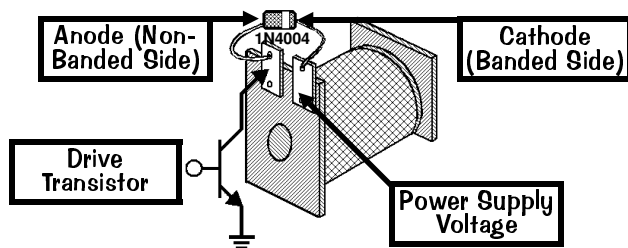

- = Coils / Flash Lamps above Playfield.
- = Coils / Flash Lamps below Playfield.
- = Coils / Flash Lamps not on Playfield.
- Color** = Color of Mini-Mars of Flash Lamp Bulb.

Some Coil or Flash Lamp Diodes may be located under the playfield, in the Cabinet or Backbox on Terminal Strips or Diode Boards and not on the assemblies. DOTS: Diode On Terminal Strip See Section 5, Chapter 2, Playfield Wiring.

Coil Q24 is Optional. If either a Coin Meter, Token Dispenser or Knocker (all optional equipment) is required, call Technical Support for more information, 1-800-542-5377 or 1-708-345-7700.

Domestic Pinball & Redemption Distributors Map

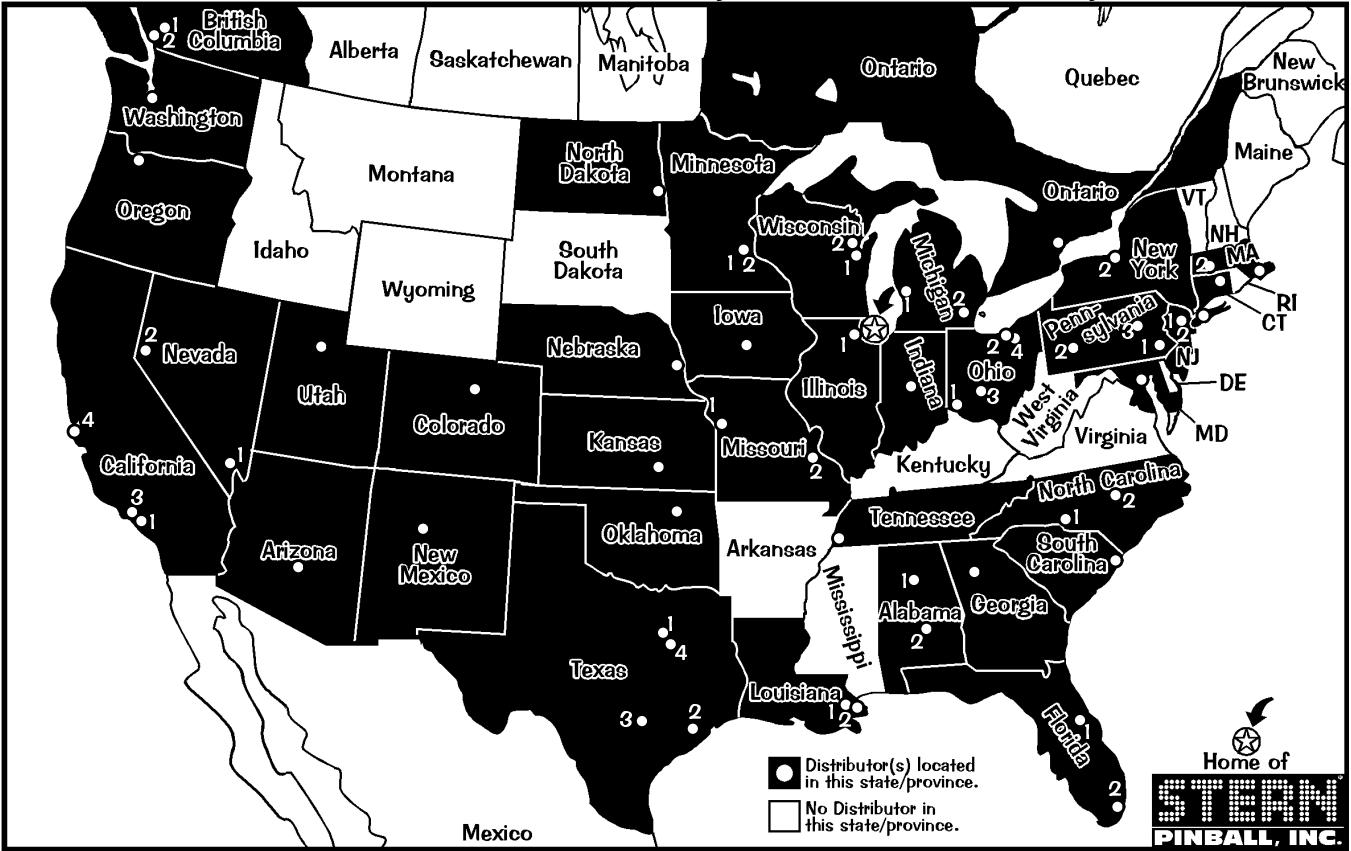

International Distributors Map

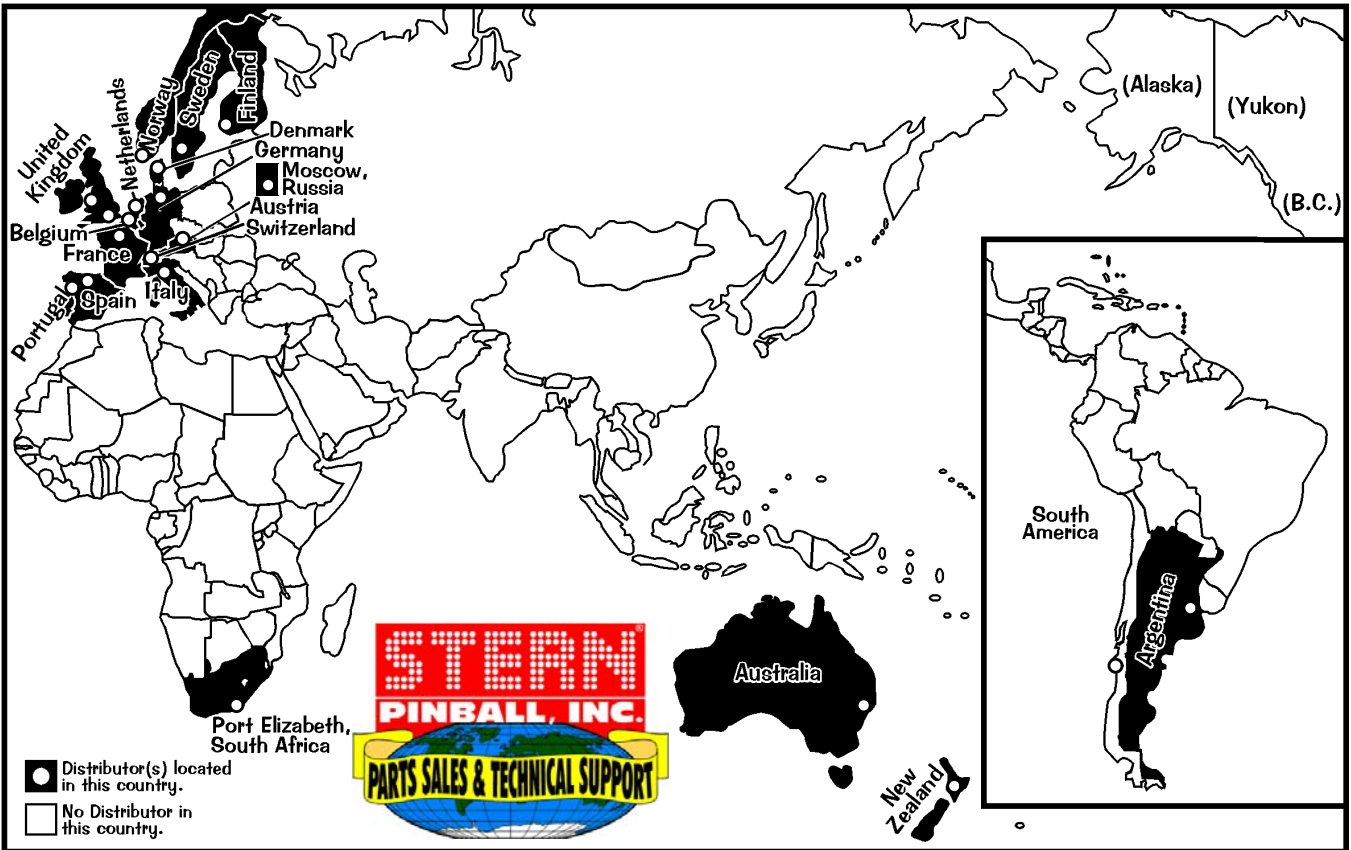

For *Parts & Service*, call your nearest Distributor. View the above maps & the directories on the next page to locate your closest Distributor in your state, province, or country. Distributors and phone numbers are subject to change. Call **Stern® Pinball, Inc. (Parts Sales & Technical Support)** with any questions or if your Distributor cannot help you: 1-800-542-5377 (in USA or Canada) or 1-708-786-5466. Visit us at www.SternPinball.com for current Distributor Information & other pinball needs.



Domestic Pinball & Redemption Distributors Directory

<p>ALABAMA</p> <p>Birmingham Vending Birmingham (1) 1-205-324-7526</p> <p>Franco Distributing Montgomery (2) 1-334-834-3455</p> <p>ARIZONA</p> <p>Betsom West Phoenix 1-480-380-8857</p> <p>Mountain Coin Phoenix 1-602-269-7596</p> <p>CALIFORNIA</p> <p>Betsom West Buena Park (1) 1-714-228-7500</p> <p>So. San Francisco (2) 1-650-952-4220</p> <p>C.A. Robinson Los Angeles (3) 1-323-735-3001</p> <p>San Francisco (4) 1-650-871-4280</p> <p>COLORADO</p> <p>Mountain Coin Denver 1-303-427-2133</p> <p>CONNECTICUT</p> <p>TDM Distributing Williamantic 1-860-423-1403</p> <p>FLORIDA</p> <p>Birmingham Vending Orlando (1) 1-407-425-1505</p> <p>Brady Distributing Miami [Miramar] (2) 1-954-874-1100</p> <p>Orlando (1) 1-407-872-1666</p> <p>GEORGIA</p> <p>Greater Southern Dist. Smyrna 1-770-803-3040</p> <p>ILLINOIS</p> <p>American Vending Elk Grove Village 1-847-439-9400</p> <p>Atlas Dist. International Elk Grove Village 1-847-952-7500</p> <p>World Wide Distributing Elk Grove Village 847-434-0400</p>	<p>IOWA</p> <p>Greater America Dist. Johnston 1-515-278-4455</p> <p>Moss Distributing Des Moines 1-515-266-6422</p> <p>INDIANA</p> <p>Atlas Dist. International Indianapolis 1-317-786-6892</p> <p>Shaffer Distributing Indianapolis 1-317-899-2530</p> <p>KANSAS</p> <p>United Dist., Inc. Wichita 1-316-263-6181</p> <p>LOUISIANA</p> <p>AMA Distributors, Inc. Metairie (1) 1-504-835-3232</p> <p>Parts & Service Only: New Orleans Novelty New Orleans (2) 1-504-888-3500</p> <p>MARYLAND</p> <p>Betsom Enterprises Baltimore 1-410-646-4100</p> <p>Parts & Service Only: Weiner Distributing Baltimore 1-410-525-2600</p> <p>MASSACHUSETTS</p> <p>Betsom Ent. (NECO) Norwood (1) 1-781-769-9760</p> <p>Gekay Sales E. Longmeadow (2) 1-413-525-2700</p> <p>MICHIGAN</p> <p>Atlas Dist. International Wyoming (1) 1-616-241-1472</p> <p>Cleveland Coin Machine Livonia (2) 1-734-432-1040</p> <p>MINNESOTA</p> <p>Lieberman Music Minneapolis (1) 1-952-887-5299</p> <p>Moss Distributing Richfield (2) 1-612-798-8030</p>	<p>MISSOURI</p> <p>Greater America Dist. Kansas City (1) 1-816-531-4300</p> <p>Moss Distributing Kansas City (1) 1-816-231-6600</p> <p>Shaffer Distributing St. Louis (2) 1-314-645-3393</p> <p>NEBRASKA</p> <p>Central Dist. Omaha 1-402-493-5600</p> <p>Greater America Dist. Omaha 1-402-553-2812</p> <p>NEVADA</p> <p>Mountain Coin Las Vegas (1) 1-702-798-0900</p> <p>Reno Game Sales Reno (2) 1-775-829-2080</p> <p>NEW JERSEY</p> <p>Betsom Enterprises Carlstadt (1) 1-201-438-1300</p> <p>Jack Guarneri Service Co., Inc. (Pinballsales.com) Lakewood (2) 1-732-364-9900</p> <p>NEW MEXICO</p> <p>Mountain Coin Albuquerque 1-505-345-7706</p> <p>NEW YORK</p> <p>Betsom Enterprises New Hyde Park (2) 1-516-354-4647</p> <p>Syracuse (3) 1-315-437-2400</p> <p>Parts & Service Only: Bay Coin Richmond Hill (1) 1-718-291-5757</p> <p>NORTH CAROLINA</p> <p>Brady Distributing Charlotte (1) 1-704-357-6284</p> <p>Operators Distributing Archdale (2) 1-336-884-5714</p>	<p>NORTH DAKOTA</p> <p>M.H. Associates, Inc. Fargo 1-701-282-7877</p> <p>OHIO</p> <p>Atlas Dist. International Cincinnati (1) 1-513-851-4100</p> <p>Cleveland Coin Cleveland (2) 1-216-692-0960</p> <p>Shaffer Distributing Columbus (3) 1-614-421-6800</p> <p>Macedonia (4) 1-330-467-4850</p> <p>OKLAHOMA</p> <p>Galaxy Distributing Tulsa 1-918-835-1166</p> <p>OREGON</p> <p>Betsom West Portland 1-503-772-4567</p> <p>Mountain Coin Portland 1-503-234-5491</p> <p>Specialty Coin Products Portland 1-503-786-9200</p> <p>Toll-Free 1-800-987-4946</p> <p>PENNSYLVANIA</p> <p>Betsom Enterprises King Of Prussia (1) 1-610-265-1155</p> <p>Pittsburgh (2) 1-412-331-8703</p> <p>Cleveland Coin Machine Pittsburgh (2) 1-412-920-1300</p> <p>Roth Novelty (Superior) Wilkes-Barre (3) 1-570-824-9994</p> <p>SOUTH CAROLINA</p> <p>Parts & Service Only: Green Coin Myrtle Beach 1-843-626-1900</p>	<p>TENNESSEE</p> <p>Brady Distributing Memphis 1-901-345-7811</p> <p>Parts & Service Only: Green G.A.M.E.S. Memphis 1-901-353-1000</p> <p>TEXAS</p> <p>Amusement Distributors San Antonio (3) 1-210-225-3844</p> <p>Betsom Texas Dallas (1) 1-214-638-4900</p> <p>Commercial Music Dallas (1) 1-214-741-6381</p> <p>Discount Arcade Games Crowley (1) 1-817-297-0440</p> <p>H.A. Franz, & Co. Houston (2) 1-713-523-7366</p> <p>San Antonio (3) 1-210-226-6322</p> <p>Master Sales Corsicana (4) 1-903-874-4740</p> <p>UTAH</p> <p>Mountain Coin Salt Lake City 1-801-262-5494</p> <p>Struve Distributing Salt Lake City 1-801-328-1636</p> <p>WASHINGTON</p> <p>Mountain Coin Seattle 1-206-682-5700</p> <p>WISCONSIN</p> <p>Pioneer Sales & Svc. Green Bay (1) 1-920-336-5800</p> <p>Menomonee Falls (2) 1-262-781-1420</p> <p>Lieberman/Viking Vend. Menomonee Falls (2) 1-262-703-4168</p>	<p>CANADA</p> <p>ONTARIO</p> <p>Starburst Coin Mach. Toronto 1-416-251-2122</p> <p>BRITISH COLUMBIA</p> <p>Parts & Service Only: Can. Coin Machine Burnaby (1) 1-604-420-4008</p> <p>Parts & Service Only: Pacific Vending Vancouver (2) 1-604-324-2164</p>
--	--	---	---	---	--

Note: For states and Canadian Provinces which do not have Distributors, call the neighboring state or province with the city closest to you (indicated with a white dot). States or Provinces with more than 1 city containing a distributor are numbered. View the map on the previous page.

Note: Distributors are subject to change. Visit us at www.SternPinball.com for current Distributor Information.

International Distributors Directory

<p>ARGENTINA</p> <p>South Company Mar Del Plata [54] 2234-95-5532</p> <p>AUSTRALIA</p> <p>Amusement Mach. Dist. Matraville [61] 2931-6-6000</p> <p>AUSTRIA</p> <p>Parts & Service Only: R. Rupp Leibnitz [43] 3452-8-6105</p> <p>Parts & Service Only: TAB Ansfelden [43] 7229-7-8040</p> <p>BELGIUM</p> <p>NAMUSCO Brussels [32] 2414-4596</p>	<p>Belgium Continued</p> <p>Parts & Service Only: Splin S.A. Liege [32] 4362-7677</p> <p>DENMARK</p> <p>JK Automater A/S Thisted [45] 9792-0925</p> <p>ENGLAND see UNITED KINGDOM</p> <p>FINLAND</p> <p>Pelika Ray-Oy Espoo [35] 5894-370-2925</p> <p>FRANCE</p> <p>Avranches Automatic Ducey [33] 2338-9-6162</p> <p>SFA Paris [33] 1532-6-8080</p>	<p>GERMANY</p> <p>ADP Gauselmann Espelkamp [49] 5741-27-3384</p> <p>Bergmann Int'l Gaming Rellingen [49] 4101-3-0240</p> <p>Witten [49] 2302-28-2540</p> <p>MEXIM Espelkamp [49] 5772-4-9422</p> <p>HOLLAND see THE NETHERLANDS</p> <p>ITALY (RSM)</p> <p>Tecnoplay S.A. San Marino [39] 5499-0-1508</p> <p>THE NETHERLANDS</p> <p>JVH Gaming Products Tilburg [31] 1359-5-3200</p>	<p>NEW ZEALAND</p> <p>Coin Cascade Ltd. Christchurch [64] 3338-1411</p> <p>Parts & Service Only: Amco Machine Supplies Auckland [64] 9846-7606</p> <p>NORWAY</p> <p>Vendomatic Oslo [47] 2291-8383</p> <p>PORTUGAL</p> <p>Jacinto & Martins, S.A. Belas [35] 1214-32-5624 or [35] 1214-32-5638</p> <p>RUSSIA</p> <p>O.D.A. Game Machines Moscow [095] 219-2949 or [095] 219-8917</p>	<p>SOUTH AFRICA</p> <p>K & W Amusements Port Elizabeth [27] 4148-4-3344 or [27] 4148-4-2940</p> <p>SPAIN</p> <p>Comercial Cocomatic Coslada (Madrid) [34] 9167-1-6980</p> <p>Parts & Service Only: Sente, S.A. Madrid [34] 9154-1-7112</p> <p>SWEDEN</p> <p>Bjuvia Fritid AB Bjuv [46] 4238-6900</p> <p>SWITZERLAND</p> <p>Novomat, A.G. Harkingon [41] 6238-8-8961</p>	<p>UNITED KINGDOM</p> <p>Electrocoin London, England [44] 2089-65-2055</p> <p>Parts & Service Only: Electrocoin AfterSales Cardiff, S. Glamorgan [44] 2920-45-0345</p>
---	---	--	--	---	---

Note: From inside the US, use prefix 011-.



Find-It-In-Front:
Dr. Pinball

THE LORD OF THE RINGS

POWER REQUIREMENTS



This game **must be connected to a properly grounded outlet to reduce shock hazard** & insure proper game operation. See *Sec. 5, Schematics & Troubleshooting, Chp. 3, Cabinet Wiring (Transformer Power Wiring)*, for transformer connections required for **Normal, High, and Low Line** conditions.



Normal Line:		110v AC - 125v AC @ 60Hz	
Domestic use an 8AMP 250v Slo-Blo Fuse.	AVG OPERATION	CURRENT: 2.8AMP WATTAGE: 329w	MAX OPERATION CURRENT: 8AMP WATTAGE: 940w
	High Line: 218v AC - 240v AC @ 50Hz		
Export use 2x 5AMP 250v Slo-Blo Fuses. (*England & Hong Kong use an 8AMP 250v S/B Fuse.)	AVG OPERATION	CURRENT: 1.8AMP WATTAGE: 412w	MAX OPERATION CURRENT: 5AMP 8AMP* WATTAGE: 1145w 1832w*
	Low Line: 95v AC - 108v AC @ 50Hz / 60Hz		
Export Japan Only use an 8AMP 250v Slo-Blo Fuse.	AVG OPERATION	CURRENT: 2.6AMP WATTAGE: 264w	MAX OPERATION CURRENT: 8AMP WATTAGE: 812w

England & Hong Kong use an 8A Fuse.

TRANSPORTATION

BEFORE TRANSPORTING



To reduce the possibility of damage, observe **ALL** precautions whenever transporting the game.

Read & follow Section 1, Chapter 1, Pinball Game Set-Up Procedures, and How to Secure the Backbox for Transporting. Remove the legs and secure the game within the transporting vehicle.

SAVE AND RETAIN ALL PRINTED INFORMATION INSIDE THE CABINET !

Shipping Box Dimensions

Height 56" Width 31"
Depth 31"
Approx. Unboxed Weight: 270lbs. (+/- 10)
Boxed Weight:

CAUTION

At least 2 people are required to move and maneuver this game. Use proper moving equipment & extreme care while handling!

GAME DIMENSIONS

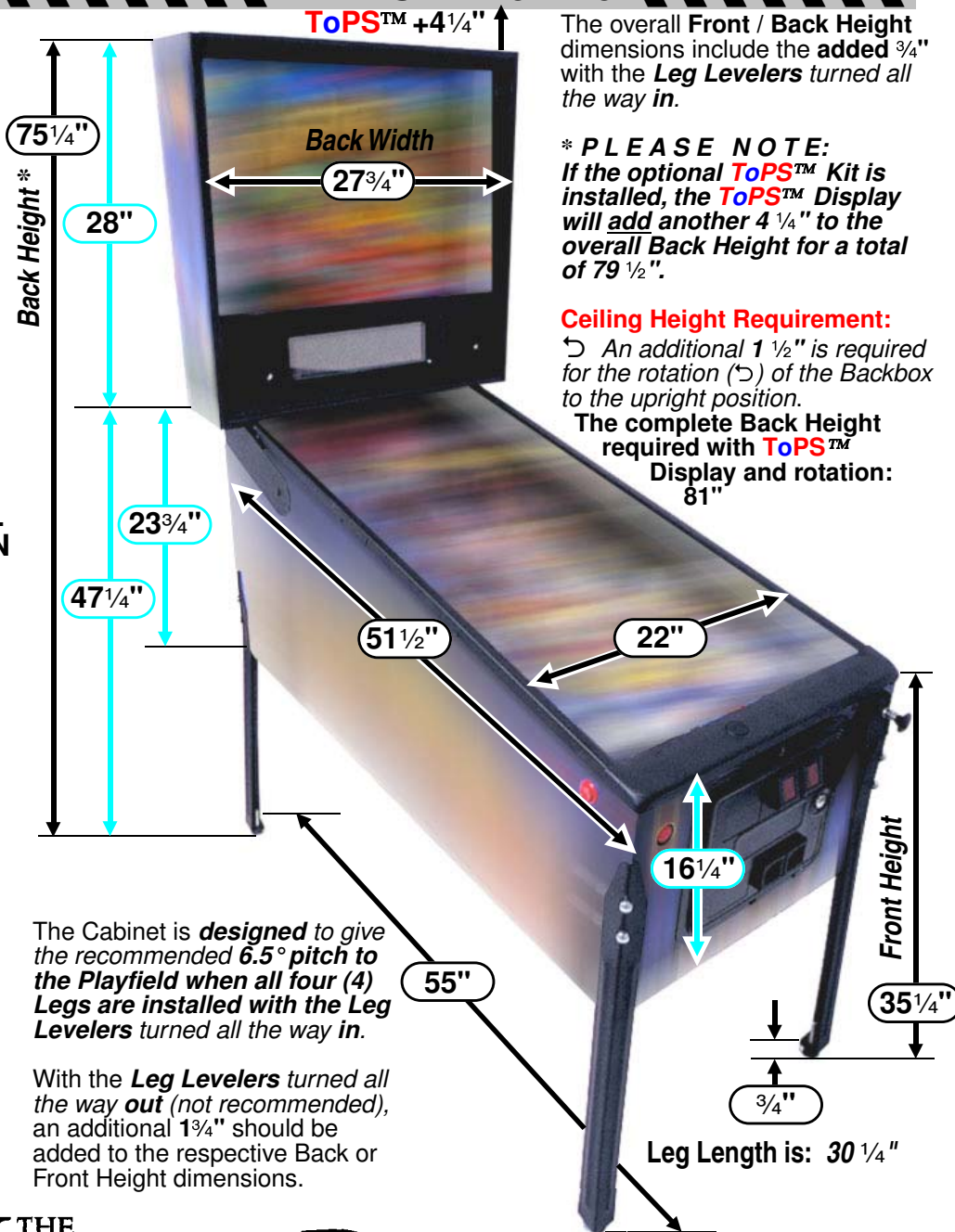

The overall **Front / Back Height** dimensions include the **added 3/4"** with the **Leg Levelers** turned all the way **in**.

*** PLEASE NOTE:** If the optional **ToPS™** Kit is installed, the **ToPS™** Display will add another **4 1/4"** to the overall **Back Height** for a total of **79 1/2"**.

Ceiling Height Requirement:
 ↪ An additional **1 1/2"** is required for the rotation (↷) of the **Backbox** to the upright position.
The complete Back Height required with ToPS™ Display and rotation:
81"

The Cabinet is **designed** to give the recommended **6.5° pitch to the Playfield** when all four (4) **Legs** are installed with the **Leg Levelers** turned all the way **in**.

With the **Leg Levelers** turned all the way **out** (not recommended), an additional **1 1/4"** should be added to the respective **Back** or **Front Height** dimensions.

THE LORD OF THE RINGS





The **The Lord of the Rings™** Pinball Game Service Manual General Table of Contents

See Sections 3 & 5, Table Of Contents, for details of that Section and it's Chapters.

For Proper Operation of Pinball Game, four (4) Pinballs must be installed!.....Inside Front

- ▶ Backbox PCB Fuses, ROMs, Bridges, Relays Playfield/Cabinet Fuses, Cab. Switches . DR. ①
- ▶ Find-It-In-Front: Dr. Pinball Section Explained ▶ How It Works DR. ②
- ▶ Diagnostic Aids ▶ CPU DIP Switch Setting DR. ③
- ▶ Switch Matrix Grid, Dedicated Switches & Locations DR. ④
- ▶ Lamp Matrix Grid & Locations DR. ⑤
- ▶ Coils Detailed Chart Table DR. ⑥
- ▶ Coil & Flash Lamp Locations DR. ⑦
- ▶ Domestic Pinball & Redemption and International Distributors Maps..... DR. ⑧
- ▶ Domestic Pinball & Redemption and International Distributors Directories DR. ⑨
- ▶ Power Requirements ▶ Transportation ▶ Game Dimensions DR. ⑩

Game Manual General Table of Contentsi-ii

SECTION 11-4

- Chapter 1, After Set-Up..... 1**
 - ▷ Pinball Game Set-Up Procedures.....1
 - ▷ Pinball Game Set-Up Future Reference.....2-3
 - ▷ How to Secure the Backbox... ▷ Leg Leveler Adjustment ▷ Easy Access... - 3 Positions..... 4

SECTION 25-6

- Chapter 1, Game Operation & Features 5**
 - ▷ Start of Game Features (Starting a Normal Game, ... Team Play, ... Tournament Play with ToPS™)
 - ▷ During Game Features (Feature Mode & Combination Shots, Multiball, Replay Feature)
 - ▷ End of Game Features (Game Endings, Match Features, Entering Initials/Name) 5
 - ▷ Auto Percentaging ▷ Instruction Card 6

SECTION 37-57

- ▷ Portals™ Service Menu System Table of Contents (detailed outline of this section)..... 7
- ▷ Portals™ Service Switch Set Access & Use (Function 1, ...; Function 2, ...; Function 3, ...) 8
- Chapter 1, Portals™ Service Menu Introduction..... 9**
 - ▷ How to Use This Section..... 9
 - ▷ Portals™ Service Menu Icon Tree10-11
 - ▷ Portals™ Service Menu Example ▶ Exiting the Portals™ Service Menu12-14
- Chapter 2, Go To Diagnostics Menu 15-31**
- Chapter 3, Go To Audits Menu 32-37**
- Chapter 4, Go To Adjustments Menu..... 38-46**
- Chapter 5, Go To Installs Menu 47-50**
- Chapter 6, Go To Reset Menu..... 51-52**
- Chapter 7, Go To Tournament Menu 53-57**

SECTION 4 58-74

- Chapter 1, Parts Identification & Location (The Pink Pages) 59**
 - Overview..... 59
 - The Lord of the Rings™ Backbox Assembly 60**
 - Speaker Panel Assy. for the Backbox & Associated Parts: 61
 - Cabinet - General Parts & Switches62-63
 - Playfield - General Parts, Metal Rails/Ball Guides & Switches (Above)64-65
 - Playfield - General Parts & Switches (Below)66
 - Playfield - Plastics (Screened & Clear) & Decals 67
 - Playfield - Rubber Parts Black (Rings Actual Size)..... 68

Section 4, Chapter 1, Parts Identification & Location (The Pink Pages) Continued on the Next Page



Playfield - Metal Posts (Screws) and Nuts (Actual Size)	69
Playfield - Hex Spacers (Actual Size).....	70
Playfield - Posts & Spacers (Actual Size).....	71
Playfield - Small Bayonet Type Bulbs & Sockets (Actual Size)	72
Playfield - Large Bayonet Type Bulb and Sockets (Actual Size)	73
Playfield - Wedge Base Bulbs and Sockets (Actual Size).....	74
Chapter 2, Drawings for Major Assemblies & Ramps (The Blue Pages)	75-98
▷ Overview	75
Ball Shooter (Plunger) Assembly, 500-6146-00-07..... (Top)	76
Autoplunger Arm Weld Assembly, 500-6091-00 with ...Coil Assembly, 500-6092-02	(Bot) 76
4-Ball Trough Assembly, 500-6318-24 and Associated Parts:.....	77
Flipper (Left) Assembly, 500-6543-11 and Associated Parts:	78
Flipper (Right) Assembly, 500-6543-01 and Associated Parts:.....	79
Diverter (3-Legged Flipper, Left) Assembly, 500-6543-32-80 and Associated Part:.....	80
Diverter Assembly & Diverter Gate Adjustment Procedure.....	81
Ball Deflector Assembly, 500-6657-03.....	82
Bumper Top Assy., 515-6459-08 (Qty. 3)..... (Top)	83
Bumper Bottom Assy., 515-6459-04 (Qty. 3)	(Mid) 83
Bumper Switch Assy., 515-6459-03 (Qty. 3) and Associated Parts:.....	(Bot) 83
Slingshot Assemblies, 500-5849-00 (Qty. 2).....	(Top) 84
VUK (Vertical Up-Kicker, Left Style) Assembly, 500-6696-00	(Bot) 84
Exit Scoop, 535-9287-00 and Associated Parts:	(Top) 85
VUK (Vertical Up-Kicker, Right Style) Assembly, 500-6696-01.....	(Bot) 85
Balrog (Motor & Gate) Individual Parts Only,.....	86-87
Orthanc Tower, Up-Kicker and Ball Trough (Up-Kicker Tray) Individual Parts Only,	88
Barad-dûr Tilting Tower Individual Parts Only,.....	89
The Lord of the Rings Playfield Figurines (Characters) Overview	90
Down Post (Sword Ball Lock) Assembly, 500-6752-00	(Top) 91
30° Eject (Saucer) Assembly, 500-6511-11 and Associated Part:.....	(Bot) 91
Upper Mini-Playfield, Left & Center Wire Ramps, Individual Parts Only,.....	92
Center, Right, Sword and Shooter Lane Ramps, Individual Parts Only,.....	93
Back Panel (Front & Back Views), Individual Parts Only,.....	94-95
Magnetic Ring Assembly, Individual Parts Only,.....	96
Back Panel Trough Assembly, Individual Parts Only,	97
▷ UK ONLY OPTIONAL: Ball Deflector Assemblies, 500-5788-02 (Qty. 2).....	(Top) 98
▷ UK ONLY OPTIONAL: Up/Down Post Assembly, 500-6293-00	(Bot) 98
SECTION 5	99-150
▷ Schematics & Troubleshooting Table of Contents (detailed outline of this section).....	99
▷ Coils Detailed Chart Table	100
Chapter 1, Backbox Wiring (The Yellow Pages)	101-102
Chapter 2, Playfield Wiring (The Yellow Pages)	103-106
Chapter 3, Cabinet Wiring (The Yellow Pages)	107-108
Chapter 4, Printed Circuit Boards (PCBs) (The Yellow Pages).....	109-150
APPENDIXES A-J	A1-J1
▷ Appendixes A-J Table of Contents (outline of this section).....	after 150
▷ Appendixes A-J	A1-J1
Plastic Part Color Chart.....	(Bottom) H1 + (Top) I1
Glossary of Terms	Last Page
Limited Warranty, Cautions, Warnings & Notices.....	Last Page
▶ Switch Matrix Grid & Dedicated Switches ▶ Lamp Matrix Grid.....	Inside Back



After Set-Up

Pinball Game Set-Up Procedures

...after reading the Pinball Game Set-Up Instruction Sheet (SPI Part N^o 755-5310-00) included with your New Pinball Game, continue with the below procedures:

With the Back Glass Removed:

1. Check all connectors in the Backbox for loose wire terminations. Reseat any loose wire by pushing in on the terminal. Push on all connectors plugged into the CPU/Sound Board, I/O Power Driver Board, and the Display Power Bd. to check that they are properly seated. Ensure Fluorescent Light Tube is seated correctly. Check that all fuses are seated properly. Close and lock the Backbox and secure its' keys back inside the Coin Door.

With the Playfield Glass Removed:

2. Make sure the proper amount of pinballs were installed (Amount of balls are always specified on decal attached to the lock down assembly and at the top of the inside cover).

3. Remove all shipping tie downs, shipping blocks, packing foam, shipping instruction pages, etc. (if any) from the game. **READ ALL PRINTED INFORMATION!** Shipping instructions, labels and/or decals describe warnings, cautions, and/or important information specific to the game. **SAVE ALL PRINTED INFORMATION.**

4. Raise the playfield and support it, by lifting the Prop Rod (located on the left, inside the cabinet). The end of the Prop Rod should be placed into the hole under playfield. See the illustration "Easy Access Service System - 3 Positions" on Page 4.

5. Visually inspect all cabinet cables and connector terminations; ensure no wires or cables are pinched and that cable harnesses are not pulled tight.

6. Lower the playfield and ensure game is level side-to-side by adjusting Leg Levelers, if required. See the illustration "Leg Leveler Adjustment" on Page 4. Start with the Leg Levelers turned all the way in (1.25" from floor to bottom of leg), depending on the condition of the floor, adjust the Leg Levelers as required until the game pitch is 6.5°, determined by the Bubble Level.

USE THE BUBBLE LEVEL ON THE WOOD RAIL (LOWER RIGHT) TO DETERMINE IF LEVEL IS ACHIEVED. BUBBLE SHOULD APPEAR BETWEEN THE 2 BLACK LINES. SEE PAGE 4 FOR AN ILLUSTRATION.

The playfield incline affects difficulty of play. Use the recommended incline; Game difficulty is best varied using game adjustments.

With the Coin Door Open:

7. If desired, perform any self tests at this time (see Section 3, Chapter 1, Portals™ Service Menu Introduction, and Chapter 2, GO TO DIAGNOSTICS MENU, for instructions on how to enter "Begin Play Test" and "Game Name Test" Menus to test components on the game).

8. If desired, adjust Game Pricing, Standard and/or Custom (see Section 3, Chapter 4, GO TO ADJUSTMENTS MENU and Section 3, Chapter 5, GO TO INSTALLS MENU to adjust Game Difficulty, 3- or 5-Ball Play, Home or Tournament Settings, Novelty, Add-A-Ball, etc.).

Per CE: "The appliance has to be placed in a horizontal position." This appliance is not to be cleaned by a Water Jet.



After Set-Up

PINBALL GAME SET-UP

CAUTION: At least 2 people are required to move and maneuver game. Use proper moving equipment & extreme care while handling. Pinball game is 200lbs (+/- 10). Refer to Game Manual for further Game Set-Up Procedures (Sec. 1, Chap. 1) and other important information!

TOOLS REQUIRED: 5/8" Socket Wrench & Utility Knife

NOTE: KEYS are tied to the Shooter Rod* (if equipped) or tied to the Playfield Glass if equipped with Auto Plunger Buttons. Remove the other set is used to unlock the Back Glass to gain access to the White Star Board System.

REMOVE THE PINBALL GAME MANUAL (stapled to side of the left end of the cabinet). Review Section 1, Chapter 1, which describes how to lift the playfield to access the Plumb Bob Assembly. The manual gives you all the important information you need to prepare for final setup and other important information (such as Parts, Diagnostics, Schematics and more...).

ALWAYS STORE THE MANUAL & INFORMATION SHEETS INSIDE THE CABINET WHEN NOT USING.

SPI Part N^o 755-5310-00

Pinball Game Set-Up Future Reference

Open up the Printable Version in both 8-1/2 X 11 & 11 X 17.

Sec. 1: After Set-Up

CAUTION: At least 2 people are required to move and maneuver game.

Use proper moving equipment & extreme care while handling. Pinball game is 260lbs (+/- 10).

Refer to Game Manual for further Game Set-Up Procedures (Sec. 1, Chp. 1) and other important information!

TOOLS REQUIRED: 5/8" Socket Wrench & Utility Knife



1. Before opening box, lay the box flat on its side with "TRUCK THIS SIDE ONLY" facing the floor.



2. Slide game out using the **Black Nylon Strapping** as a handle.

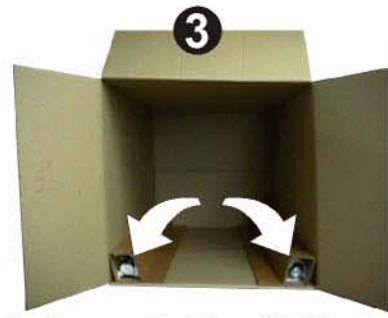

3. Remove the **Four (4) Identical Legs with Levelers** from the carton and set aside. (**SAVE!** all packing materials and information sheets related to this pinball until Set-Up is complete.)

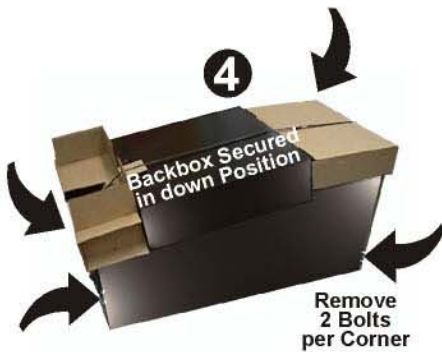

4. At this point **DO NOT CUT STRAPPING** (You want to keep the Backbox secured in the down position). Loosen and remove the 8 Leg Bolts (use 5/8" Socket Wrench) and set aside.



5. Lift game into an **UPRIGHT POSITION** (Coin Door Facing Up).

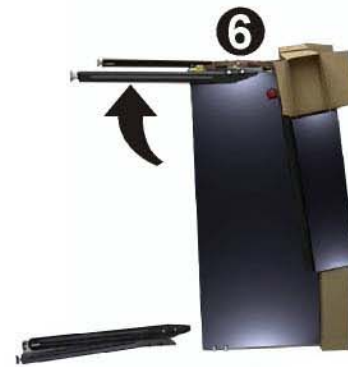

6. Install **FRONT LEGS** using the bolts removed from **Step 4**. Secure tightly. **Take care not to scratch the Black Finish on any of the Legs.**



7. Carefully set the game down on the **FRONT LEGS**. Care should be taken...Game is heavy, two (2) people are recommended for this and the following step.



8. Using supports or two (2) people, prop the rear of the cabinet up and install **REAR LEGS**. Secure tightly.



9. Cut **BLACK NYLON STRAPPING**. **CAUTION:** Strapping will **SNAP**, protect your eyes! Use extreme care when using a utility knife or scissors.



Pinball Game Set-Up Future Reference Continued

Sec. 1: After Set-Up

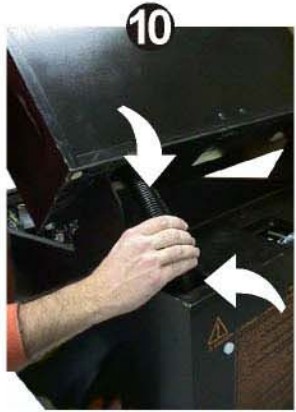

10. Lift the Backbox into the **UPRIGHT POSITION** (Ensure the cables do not get pinched).



11. After the **BACKBOX** is in the **UPRIGHT POSITION**, locate the **5/16" HEX KEY**. While inserted, rotate **KEY** with a **3/4 turn** until latched & locked.



12. The next step you will remove the **PLAYFIELD GLASS & BACK GLASS** to access the inside of the cabinet & Backbox.

NOTE: KEYS are tied to the **Shooter Rod*** (if equipped) or taped to the **Playfield Glass** (if equipped with **Auto Plunger Button**). Remove keys. One (1) set of keys opens the **Coin Door**, the other set is used to unlock the **Back Glass** to gain access to the **White Star Board System**.



13. Open the **Coin Door** and pull the **YELLOW HANDLE** to the **LEFT** and at the same time pull up on the **FRONT TOP MOLDING** and remove. The **GLASS** can now be pulled out towards you and removed. **TAKE CARE** while moving; set glass on a safe surface.



14. Through the open **Coin Door**, remove the **RETAINING RING** at the rear of the **CASH BOX** and open. Remove the **PINBALLS & the PLUMB BOB** from the **SPARE PARTS BAG**. (Save the other spare parts in cabinet). Install the **PINBALLS** by placing them on the playfield so they can roll into the **Outhole Ball Trough**.

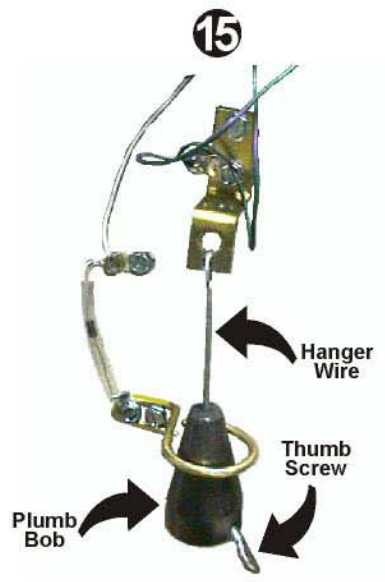

15. Install the **PLUMB BOB** on the **Hanger Wire** & tighten the **Thumb Screw**. Loosening the **Thumb Screw** & lowering or raising the **PLUMB BOB** makes the **Games Tilt Function** more or less sensitive.

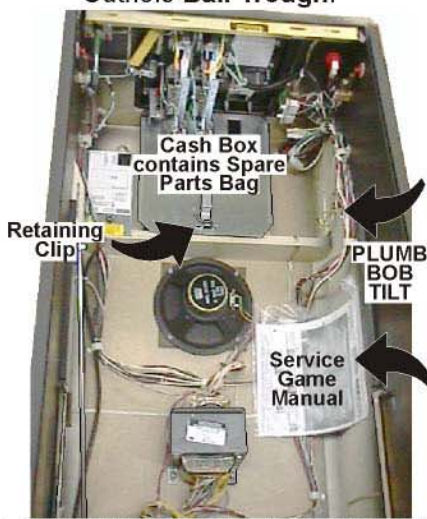

Remove the **PINBALL GAME MANUAL** (stapled to side of the left wall of the cabinet). Review **Section 1, Chapter 1**, which describes how to lift the playfield to access the **Plumb Bob Tilt Assembly**. The manual gives you all the important information you need to prepare for final set-up and other important information (such as Parts, Diagnostics, Schematics and more...).

ALWAYS STORE THE MANUAL & INFORMATION SHEETS INSIDE THE CABINET WHEN NOT USING.

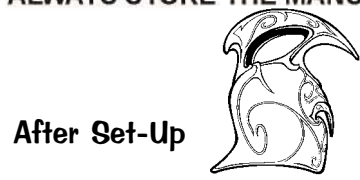

How to Secure the Backbox for Transporting

Sec. 1: After Set-Up

For more Backbox details & part numbers, see Section 4, Chapter 1, **Backbox Assembly**, Pages 60-61.

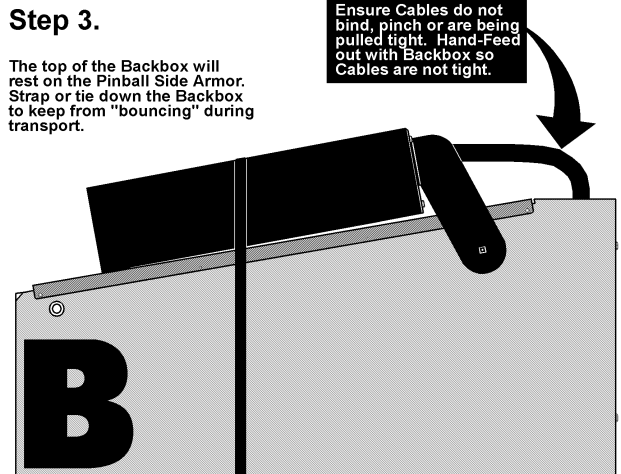
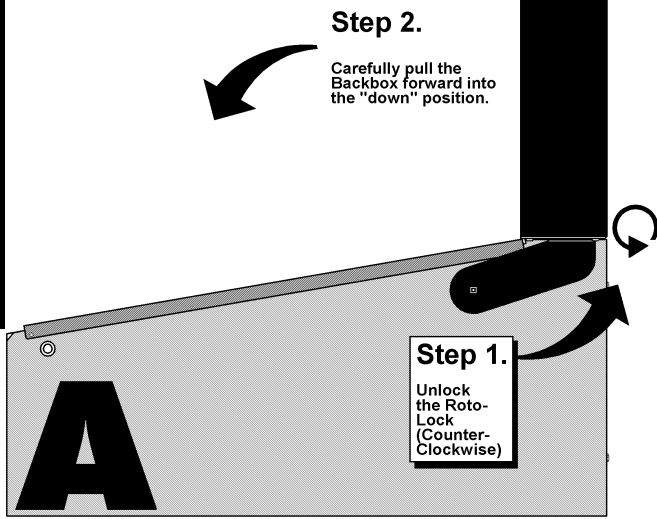

Leg Leveler Adjustment

Attach the four (4) Leg Assemblies to cabinet corners with the eight (8) leg bolts provided .

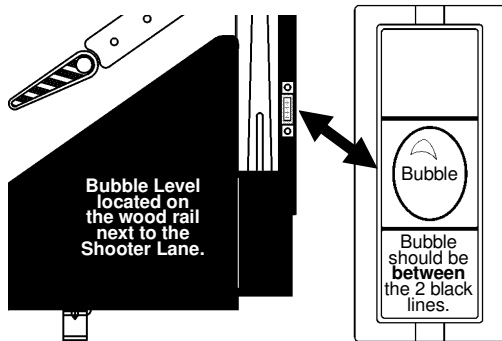

Start adjustment with the leg levelers *turned all the way in*.

View the *bubble* in the level provided on the right side wood rail.

Adjust the front or rear levelers as necessary to cause the bubble to float between the two (2) black lines.

Use a pinball to roll down the center of the playfield for side-to-side leveling.

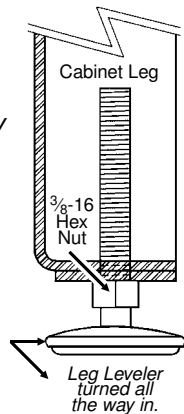

YOUR PLAYFIELD PITCH IS NOW AT 6.5° AS REQUIRED FOR PROPER GAME PLAY!

Note: For custom adjustment greater than >6.5° can be achieved by turning out the rear leg leveler(s), however, it is not recommended.

Easy Access Service System - 3 Positions

With the front molding & glass removed, carefully lift the playfield (*take care when using the Bottom Arch to hoist*).

Positions 1 & 2

When lifted high enough, the **Playfield Support Slide Brackets** (Fig. 1A) can be seen & can clear the cabinet front. At this time, pull the playfield toward the front of the cabinet, checking that the mechanical components clear the cabinet front, then rest the playfield on the **Playfield Support Slide Brackets** at the front channel of cabinet (Fig. 1C); Or, the **Prop Rod** (located on the right inside of cabinet) can be used by positioning the **Prop Rod** end into the receiving playfield hole (Fig. 1B).

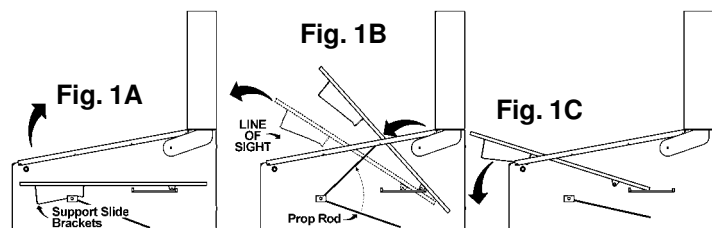

Position 3

With the playfield at rest, hold the sides & pull toward the front of the cabinet (approx. 6" to 8"), until resistance is felt from **Edge Slide Brackets** stopping against the **Slide & Pivot Support Brackets** located on either side of the cabinet (Fig. 2A). At this time, swivel the playfield toward the Backbox, then rest on the top edge (Fig. 2B & 2C).

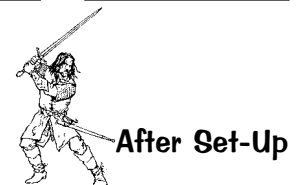
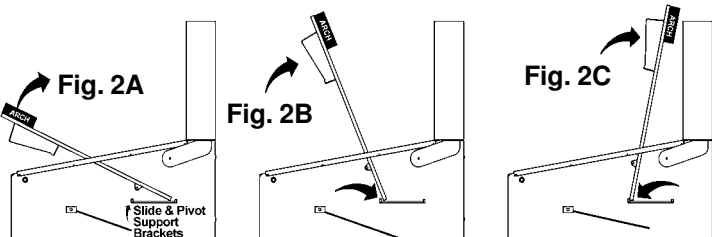

Game Operation & Features

Start of Game Features

Starting a Normal Game

Insert coin(s). The game generates a sound for the first coin & for each subsequent coin with the display indicating the number of credits posted. Press the **Start Button** and a start-up sound is produced, and the posted credits are reduced by one. Subsequent players can be added (**up to 4 can play!**) by pressing the **Start Button** before the end of ball 1 (*with sufficient credit in the game*).

The display now indicates the player or # of players selected from the total depressions of the **Start Button**. The display indicates the ball in play, and a ball is served to the *Shooter Lane*. An introduction is shown followed by Skill Shot Graphics and/or instructions. Pressing the **Start Button** after ball 1 of any player will start a new game (*if credits are available*), **but only** if the **Start Button** is depressed for 2-3 seconds. This delay is to avoid accidental "re-starts" of a game. **Note:** *Any partial credit remaining during game play after the end of ball 1, or power down, will be eliminated.*

Starting Team Play (Doubles!)

This option is adjustable with **Standard Adj. 50, Team Scores** (Default = **NO**). If **Standard Adj. 50, Team Scores** is changed to **YES**, then Team Play will be made available. **Team Play only works in a 4-Player Game**. The totals for Players 1/ 3 (Team 1) & Players 2 / 4 (Team 2) are then displayed individually **as well as** the combined score for **BOTH TEAMS**.

Starting Tournament Play with

This Pinball Game is **ToPS™ (Tournament Pinball System) Ready**. **Optional Tournament equipment & hardware (sold separately) is required**. Review **Section 3, Chp. 7, GO TO TOURNAMENT MENU**, for more info!

Unlike a "Normal Game", the Tournament Game is started by depressing the **Tournament Start Button** (*located on the Front Molding, if installed*). If adequate credit(s) are posted **and a Tournament is started** via **Portals™** (*select the "TOUR" Icon in the Main Menu*), the **Tournament Start Button** will flash. *Any adjustments or installs changed will not be in affect. Starting a Tournament Game defaults to preprogrammed Tournament Rules (e.g. No Extra Balls, Specials or Bonus Credits are awarded); however, starting a Normal Game after a Tournament Game will then revert back to any unique adjustments or installs performed previously.* **During and End of Game Features** operate in the same manner (*differences in adjustment defaults are present*).



Game Operation
& Features

During Game Features

Feature Mode & Combination Shots

Features are lit on the playfield and started by completing *certain shots (e.g. completion of Target Banks, Orbit(s), Ramp(s) and/or any combination of the shots)*.

Multiball

Multiball is started after completion of certain features (*amount of balls used depends on game rules*).

Replay Feature

Replay awards are given as the player exceeds a High Score Level during game play. This can be adjusted with **Standard Adj. 3, Replay Award** (Default = **CREDIT**). Players exceeding the High Score Levels can receive: **CREDIT**, **EXTRA BALL**, or **SPECIAL**. Adjust to **NONE** if a replay award is not desired.

End of Game Features

Game Endings

When all player(s) have played all balls (including any Extra Balls), the game ends. If power is interrupted during the course of a game, it will end that game (**see Starting a Normal Game**). Closure of the Plumb Bob Tilt Switch according to the number of tilts set, **Standard Adj. 15, Tilt Warnings** (Default = **01**) or prolonged closure, will end the current Ball-In-Play. Closure of the Slam Tilt Switch on the Coin Door ends the current game(s).

Match Feature

At the end of each ball, earned bonuses are collected. At the end of the last ball of a game (including any extra balls, if applicable), earned bonuses are collected, then the system produces a random 2-digit number (a multiple of 10; 00 to 90). Matching the last 2 digits of the player's score with this number awards a credit. In **Std. Adj. 13, Match Percentage** (Default = **8%**) can be changed from 0-10%. Changing the percentage to **0% displays** the "Match Animation" at the end of the game, however, will never match nor award anything. Changing this adjustment to **OFF** will **not display** the "Match Animation" nor award anything.

Entering Initials/Name

If player achieved a new *High Score* in a game or achieved a *Special Feature (if given)* the player may enter 3 Initials. In **Std. Adj. 29, High Score Initials** (Default = **3 Initials**) can also be changed to **10-Letter Name**. Use the **Flipper Buttons** to choose a letter or character as seen on the Dot Display. Hitting the **Start Button** locks in the letter or character and proceeds to the next letter. The game then proceeds into the **Game-Over Mode** and then to the **Attract Mode**.

Note: **Standard Adj. 31, Custom Message** (Default = **ON**) can be displayed during the *Attract Mode*; enter letters in the same fashion.

For more details on Adjustments, see Sec. 3, Chp. 4.

Continued Next Page.

Auto Percentaging

This game is equipped with Auto Percentaging, **Standard Adj. 01, Replay Type** (Default = **AUTO**, adjustable). The *Replay Percent* is automatically adjusted, **Standard Adj. 02, Replay Percentage**, or you can set a *Fixed Replay Score*. Four levels may be selected. Adjustments allow awarding of a "CREDIT" (or your setting) as each level is exceeded. This can be adjusted with, **Standard Adj. 03, Replay Award** (Default = **CREDIT**). With the **Autopercentage Feature**, if the actual replay percentage is higher or lower than that desired, the game will automatically adjust for the new recommended percentage score(s). You may choose to make a different "score-to-beat" adjustment; this is done by utilizing **Standard Adj. 04, Replay Levels**. *For more details with Adjustments, see Section 3, Chapter 4, GO TO ADJUSTMENTS MENU; also, see Section 3, Chapter 5, GO TO INSTALLS MENU for further customization of your Pinball Game.*

Sec. 2: Game Op.

Instruction Card

Below is a **COPY** of the Game Instruction Card (SPI N°: 755-5180-00 USA) which is included with every game. If your card is lost or damaged, simply **COPY** this page and *cut out* the Instruction Card as a *temporary replacement* until a *new card* is ordered.

(Hint: **COPY & CUT** along the dotted line and fold in the center to keep the "COPY" sturdy.)

COPY & CUT



For more detailed game rules, visit our website @ www.SternPinball.com and click on the "The Lord of the Rings™" or "Game Archive" Pop Bumper Link.

FOLD HERE

Click on card to open the Instruction Card for printing.

Skill Shot Time your plunge to select your target (*watch Shooter Lane*).

Rings of Power Shoot the 4 *Ring Shots* to collect **Rings of Power** :

- 3 Rings of Elves Lights Mode Start on *Center Ring Shot*.
- 7 Rings of Dwarves Lights *Mystery Award* on *Hobbiton*.
- 9 Rings of Men Lights *Gollum Multiball* on *Right Saucer*.

Movie Multiballs Play all 3 *Movie Multiballs* to light **Destroy the Ring** :

- The Fellowship of the Ring™ Shoot every shot to collect the 9 *Members of the Fellowship*.
- The Two Towers™ Spell K E E P on *Bottom Lanes* to light *Sword Lock*, then lock 3 Balls on the *Sword*.
- The Return of the King™ Collect 5,000 souls on the *Paths of the Dead (Mini-Playfield)*.

Gifts of the Elves Win a *Ring Mode* or a *Movie Multiball* to earn a wondrous Gift from the Elves.

Palantir Shoot *Barad-dûr* to light the *Palantir*, then shoot the *Palantir* to aid your quest.

© NLP, Inc. (TM) Tolkien Enterprises under license to New Line Productions, Inc. SPI PART N°: 755-5180-00 USA





Section 3 Service Menu System Table of Contents



Service Switch Set (Red, Green & Black Buttons) Access & Use	8
◇ Function 1, Volume Menu / Function 2, Service Credits Menu / Function 3, Portals™ Service Menu	8
Chapter 1, Portals™ Service Menu Introduction	9
How to Use This Section	9
Portals™ Service Menu Icon Tree for The Lord of the Rings™ Pinball	10-11
◇ Example	12-13
QUIT THIS SESSION (Exiting the Portals™ Service Menu) & Problem / Solution Table	14
Chapter 2, Go To Diagnostics Menu (Overview)	15
GO TO DIAGNOSTICS MENU	15
Go To Switch Menu ■■ Switch Test ■■ Active Switch Test ■■ Dedicated Switch Test	16
◇ Switch Matrix Grid & Dedicated Switches	17
◇ Switch Matrix Grid Locations, Typical Switch Wiring & Schematic, Dedicated Switch Schematic	17
Go To Coil Menu ■■ Single Coil Test ■■ Cycling Coil Test.....	18
◇ Partial Coils Detailed Chart ...	19
◇ Coil & Flash Lamp Locations, Typical Coil Wiring, Bulb Types used for Flash Lamps	19
◇ Coils Detailed Chart Table	20
◇ Backbox I/O Power Driver Board Detailed Wiring Diagram	21
Go To Lamp Menu ■■ Single Lamp Test ■■ Test All Lamps ■■ Row & Column Lamp Tests.....	22
◇ Lamp Matrix Grid	23
◇ Lamp Matrix Grid Locations, Typical Lamp Wiring & Schematic, Bulb Types used for Lamps.....	23
Test Flash Lamps ■ Clear Ball Trough.....	24
Technician Alerts (Switch Detection and Pinball Detection)	24-25
Service Phone # ■ Begin Play Test	25
Fire Knocker ■ Sound / Speaker Test (Speaker Phase Testing) ■ Begin Burn In.....	26
Dot Matrix Test (Dot Matrix Display Explained)	26-27
LOTR Tests: Ring Magnet Test, LED Test & Balrog Test.....	27-28
Go To Fuse Table (with Example).....	29
BACKBOX LAYOUT LOCATIONS: Fuses, Bridges, Relays & ROMs.....	30
Dr. Pinball ■■ Coil Flow Chart ■■ Switch Flow Chart ■■ Lamp Flow Chart	31
Chapter 3, Go To Audits Menu (Overview)	33
◇ EARNINGS & STANDARD AUDIT TABLES.....	32
GO TO AUDITS MENU.....	33
Earnings Audits (01-14).....	33
Standard Audits (01-68).....	34-35
Feature Audits (01-154).....	36
Go To Printer Menu ■■ Quick Printout ■■ Full Printout ■■ Reset Printer	37
Chapter 4, Go To Adjustments Menu (Overview)	39
◇ STANDARD & FEATURE ADJUSTMENT TABLES.....	38
GO TO ADJUSTMENTS MENU	39
Standard Adjustments (01-52).....	39-43
Feature Adjustments (01-34).....	44-46
Custom Message (Direct Access to Standard Adjustment 31).....	46
Chapter 5, Go To Installs Menu (Overview)	47
GO TO INSTALLS MENU.....	47
Install Extra Easy, Easy, Normal, Hard or Extra Hard.....	47
Install Directors Cut ■ Install 3-Ball or 5-Ball ■ \$.50 Competition ■ Free Play Competition	48
Install Home Play ■ Film Star Reset ■ Install Novelty ■ Install Add-A-Ball ■ Install Factory	48
◇ Overview of Standard Adjustment Changes upon selectoin of an Install:	49
◇ Overview of Feature Adjustment Changes upon selection of an Install:	49-50
Chapter 6, Go To Reset Menu (Overview)	51
GO TO RESET MENU	51
Reset Coin Audits ■ Reset Game Audits ■ Reset High Scores ■ Reset Credits ■ Factory Reset	51
◇ Example	52
Chapter 7, Go To Tournament Menu	53
GO TO TOURNAMENT MENU (OPTIONAL USE ONLY).....	53
◇ TOURNAMENT ADJUSTMENT TABLES & TOURNAMENT AUDIT TABLE	54
Tournament Adjustments (01-13)	55
Start Tournament ■ Stop Tournament ■ Tournament Prizes ■ Tournament Audits (01-12).....	56
Tournament Audits Continued ■ Sign Messages A-B (Tournie Adj. 14-15)	57

Service Switch Set (Red, Green & Black Buttons) Access & Use

The **Service Switch Set** provides access for **three (3) functions** available for your use. They are **Volume Menu**, **Service Credits Menu** and **Portals™ Service Menu**. All are accessed separately depending on which colored button (**Red**, **Green** or **Black**) is **pushed first**.

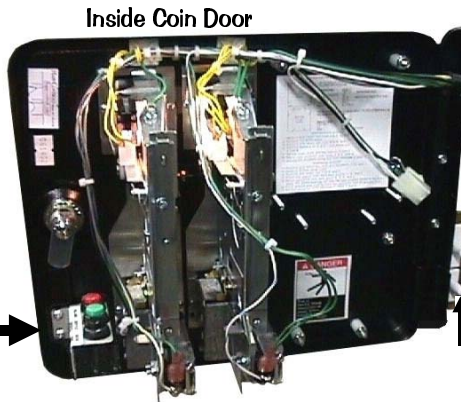

If Coil & Flashlamp Testing, the Playfield Power Interlock Switch must be pulled out.

The Memory Protect Switch is disabled when the Coin Door is open (required for any changes...)

To access any of these **three (3) functions** you must first open the **Coin Door** (see pictorial above) with the Game in the **Attract Mode** (not already in any Function or Menu stated below).

Sec. 3: ...Menu Intro.

Function 1, Volume Menu



Pushing the **Red "VOLUME" Button** first, enters the **Volume Menu**. While in this Mode, to **DECREASE** the volume, hold down or depress the **Red "LEFT" Button** until desired the volume is achieved; to **INCREASE** the volume, hold down or depress the **Green "RIGHT" Button** until the desired volume is achieved.

Note: Pushing the **Left or Right Flipper Buttons** operates the same as the **Red or Green Buttons** of the Service Switch Set, while in this Volume Mode.

Set between **0-31**; Once your adjustments are made, this menu will **automatically exit** a few seconds after the last button depression.

Function 2, Service Credits Menu



Pushing the **Green "SERVICE CREDITS" Button** first, adds **Service Credits** (will not affect your audits as "paid" credits). This is useful for the technician to test games in regular play without affecting the game audits. Each depression adds **1 credit**; up to **50 credits** can be applied. **Std. Adj. 16, Credit Limit**, determines this, however, it can be changed from 04-50; for details see **Chapter 4 of this Section 3**. Once your credits are added, this menu will **automatically exit** a few seconds after the last button depression.

Note: This function is disabled if **Standard Adjustment 30, Free Play**, is set to **YES**. The Service Credits are limited to the Credit Limit in addition to any paid credits present in the game (e.g. If the Credit Limit is 30, and there are 8 paid credits present, only 22 Service Credits can be applied.).

open
Adjustments

Function 3, Portals™ Service Menu

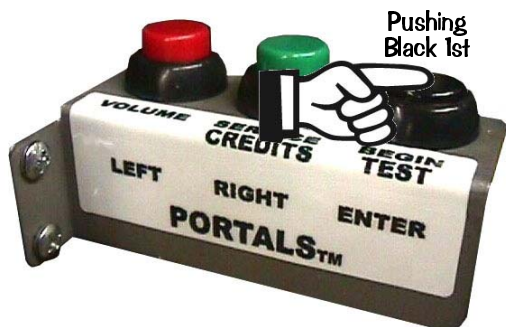

Pushing the **Black "BEGIN TEST" Button** first, enters the **Portals™ Service Menu**. Once in, navigate through all menus depressing the **Red "LEFT" or Green "RIGHT" Buttons**.

Note: Pushing the **Left or Right Flipper Buttons** operates the same as the **Red or Green Buttons** of the Service Switch Set, while in this Service Mode.

Select or activate the **Icon** chosen (the **Icon** will be "flashing") by pushing down or depressing the **Black "ENTER" Button**.

Note: Pushing the **Start Button** operates the same as the **Black Button** of the Service Switch Set, while in this Service Mode.

Please read the remainder of this Chapter for more information on the **Portals™ Service Menu**. The remaining six (6) Chapters of this Section explains all **Icons & Menus** in detail. **Read! Read! Read!**



Portals™ Service Menu Introduction

Important: The *Dual Switch Bracket* holds the *Playfield Power Interlock & Memory Protect Switches*. It is located just inside the Coin Door frame (see pictorial of the *Coin Door* on the previous page). The Button Switch at the top is the *Playfield Power Interlock Switch*. It must be pulled out for electro-mechanical device testing or diagnostic purposes (this is required). If this button is pushed in, the *Playfield Power* is disabled while the *Coin Door* is **OPEN**. The Button Switch at the bottom is the *Memory Protect Switch*. It is enabled while the *Coin Door* is **CLOSED**; meaning any adjustment changes that are made **will not be written to memory**. If changing adjustments is required, ensure the *Coin Door* is **OPEN** to disable this switch, thus allowing for desired changes.

How to Use This Section

This section will cover all functions available in the **Portals™ Service Menu** in a *Step-By-Step* process. This section is divided into chapters which coincide with the **MAIN MENU**. The previous and following pages in this Chapter will instruct the operator on how to move through the Menus. It's simple, easy and fun to use!

To get into the **Service Menu Mode** review "**Function 3, Portals™ Service Menu**" on the previous page. After Power-Up, push down the **Black "BEGIN TEST" Button** to begin. Looking at the display you will momentarily see "**Service Menu**" with a *satellite flying from right to left pulling a banner "Portals©™"* followed by the **MAIN MENU**:

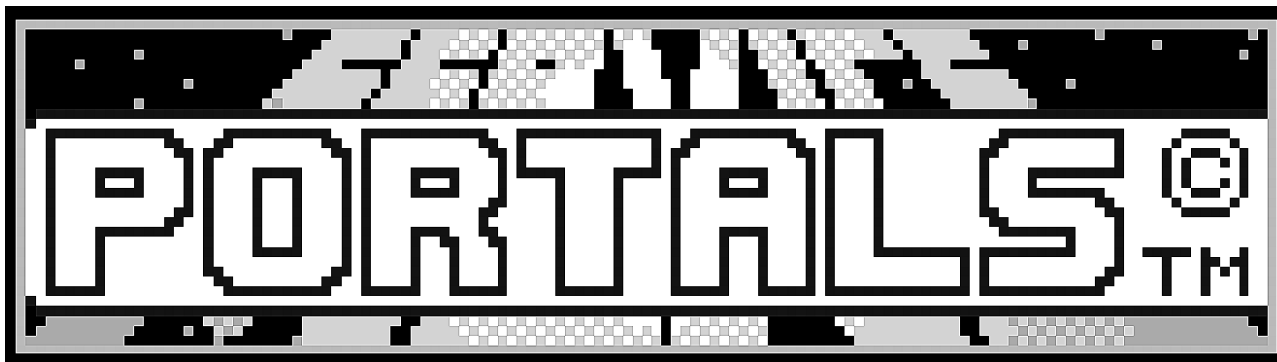

Use the **Red "LEFT" & Green "RIGHT" Buttons** (or **Left & Right Flipper Buttons**) to move the selected *Icon* left or right, and the **Black "ENTER" Button** (or **Start Button**) to activate the selected *Icon*. The use of the **Service Switch Set (Red, Green, & Black Buttons)** *is required* in **Switch Test** or **Active Switch Test**, as the **Start & Flipper Buttons** are a part of this test.

The **MAIN MENU** now appears with the "**DIAG**" *Icon* (**GO TO DIAGNOSTICS MENU**) flashing:



As the operator views the Menu Screen(s), the **MORE MORE** symbols indicates that there are more *Icons* to select in each direction. The *Icon* selected will blink. Pushing the **Black "ENTER" Button** (or **Start Button**) will select the *Icon* and the Menu Screen will change to the menu selected. Select the "**PREV**" *Icons* to move backwards through the menu levels. Select the "**QUIT**" *Icon* to completely exit the Service Mode.

View the **Portals™ Service Menu Icon Tree** on the next pages for a complete overview of all menus used in this system. The "**HELP**" *Icon* & "**?**" *Mini-Icon* provide explanation of **ICON** usage in the Menu where the "**HELP**" *Icon* or "**?**" *Mini-Icon* was selected. View **QUIT THIS SESSION (Exiting the Portals™ Service Menu)** at the end of this chapter (reference **Section 3, Chapter 1, Portals™ Service Menu Introduction**).

The **chapters** in this **section**, which coincide with the **MAIN MENU**, will also provide more detailed information. **Use both the manual and the display to help customize, troubleshoot and/or diagnose faults, if any.**



THE LORD OF THE RINGS Portals™ Service Menu Icon Tree

**COIN DOOR IS OPEN
PLAYFIELD HIGH POWER
DISABLED BY
COIN DOOR INTERLOCK**

* WHEN ENTERING THESE NOTED MENUS, YOU MUST PULL OUT the Power Interlock Switch for operation with the Coin Door open.

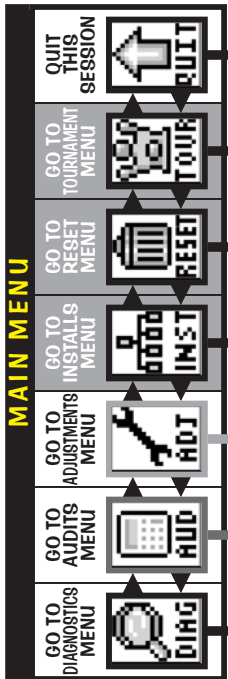

These **non-selectable** icons appear in the selected Menu only when there are **MORE** icons to the **LEFT** or to the **RIGHT** available for selection.

CONTINUED NEXT PAGE.

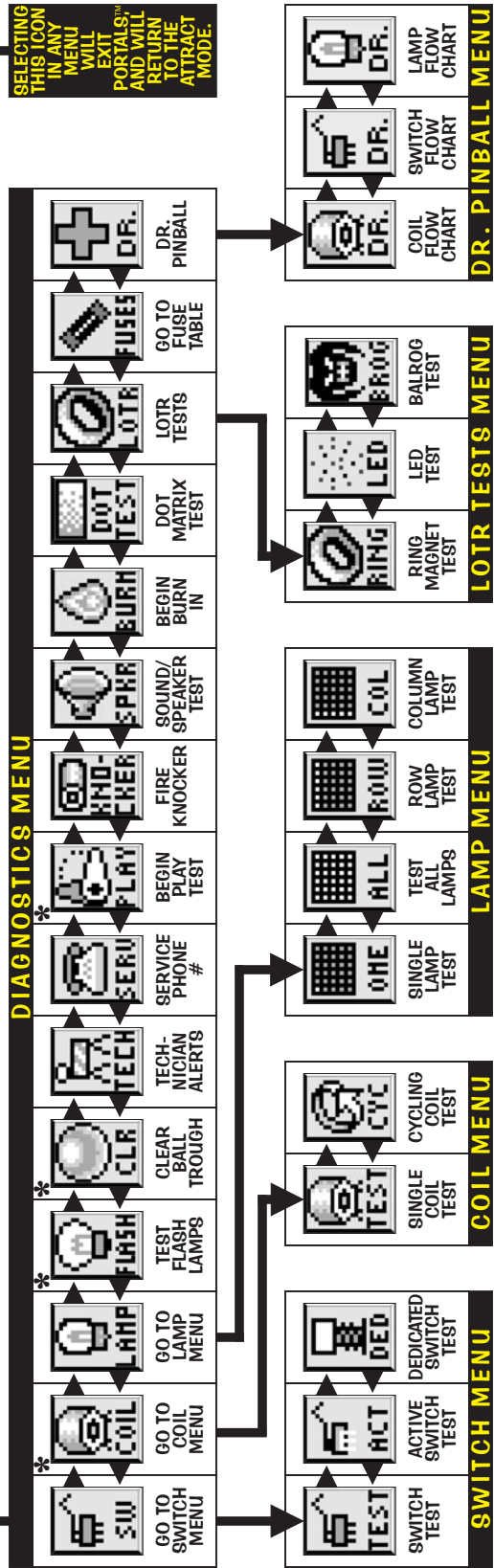

SELECTING THIS ICON IN ANY MENU WILL EXIT PORTALS™ AND WILL RETURN TO THE ATTRACT MODE.

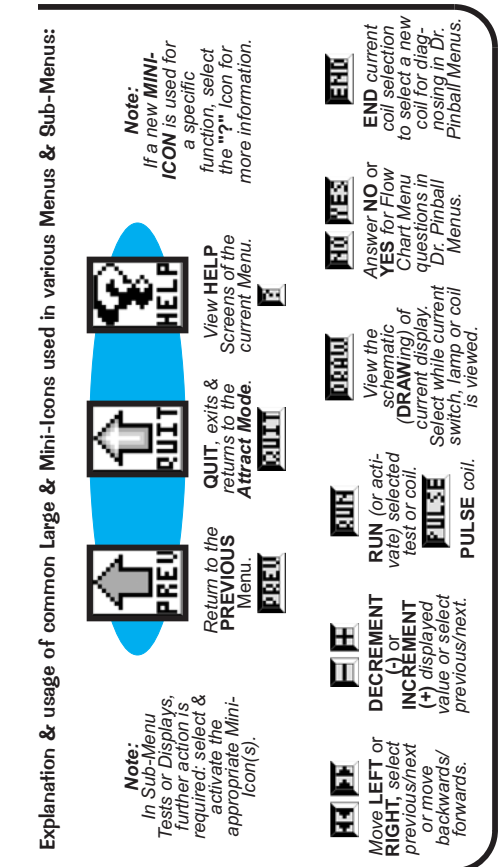
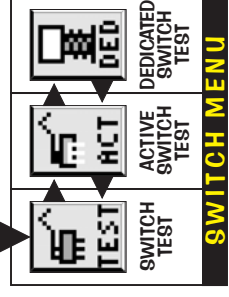
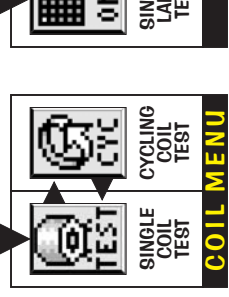
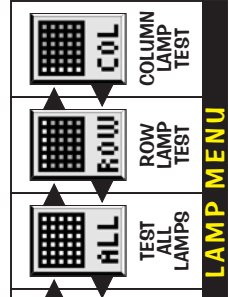
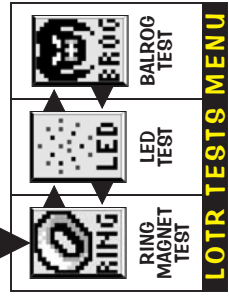
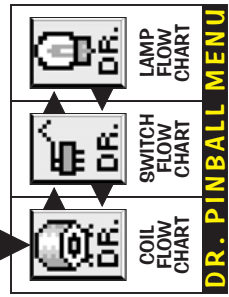

OPTIONAL PRINTING KIT (sold separately) IS REQUIRED FOR OPERATION OF THIS MENU.

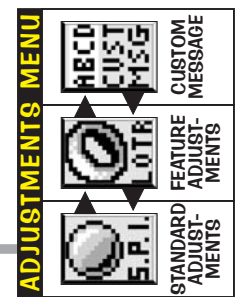
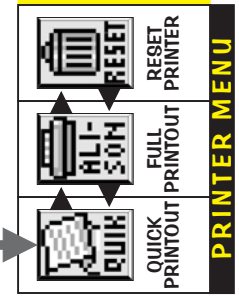

Note: In Sub-Menu Tests or Displays, further action is required: select & activate the appropriate Mini-Icon(s).

Note: If a new MINI-ICON is used for a specific function, select the "P" icon for more information.

PREV Return to the PREVIOUS Menu.

QUIT QUIT, exits & returns to the current Menu.

HELP View HELP Screens of the current Menu.

END END current coil selection to select a new coil for diagnosing in Dr. Pinball Menu.

YES Answer NO or YES for Flow Chart Menu questions in Dr. Pinball Menu.

NO Answer NO or YES for Flow Chart Menu questions in Dr. Pinball Menu.

DRWD View the schematic (DRAWING) of current display. Select while current switch, lamp or coil is viewed.

RUN RUN (or activate) selected test or coil.

FALSE Select while current switch, lamp or coil is viewed.

PULSE PULSE coil.

DECR DECREMENT (-) or INCREMENT (+) displayed value or select previous/next.

LEFT Move LEFT or RIGHT, select previous/next or move backwards/ forwards.



THE LORD OF THE RINGS Portals™ Service Menu Icon Tree Continued

Note: After selection of any of the 1st 13 Install Icons, the request is installed and returns to the Install Menu. The last icon activated before exiting this menu will supersede any previous icon selected in the group.

Note: After selection of any of the 1st 4 Reset Icons, the request is installed and returns to the Reset Menu. Selecting a "FACT" icon, the request is installed and exits the Portals™ Service Menu System.

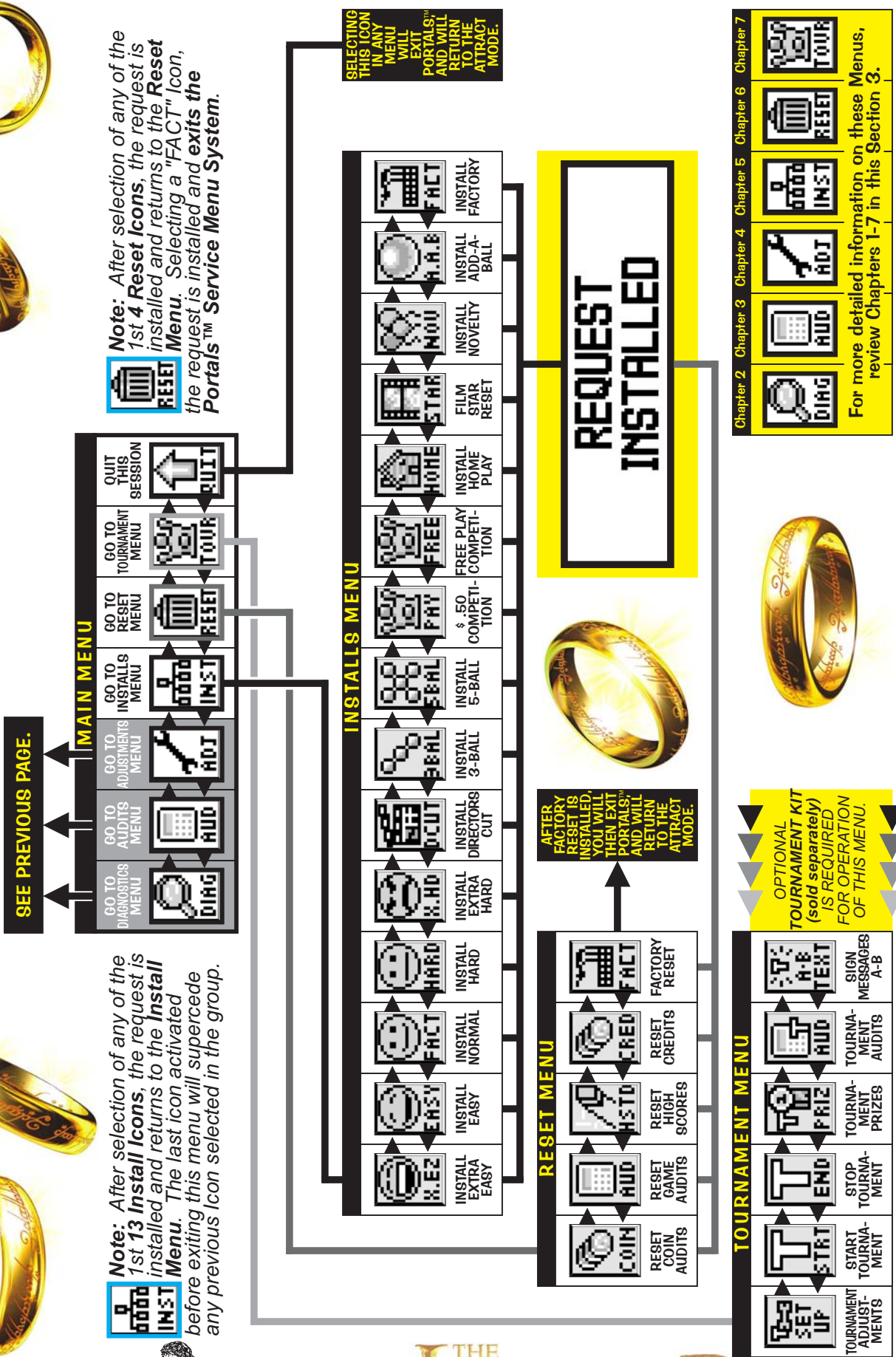

Portals™ Service Menu Example

This example will demonstrate activation of *Icons* in the **DIAGNOSTICS MENU**. The example will show activation of the "SW" *Icon* (**GO TO SWITCH MENU**). In this menu, the switches can be tested individually and also all active switches can be tested. Use the same technique to access all the *Icons* in the **Portals™ Service Menu**. Follow **Portals™ Service Menu Icon Tree** on the previous pages as a guide to help navigate through the entire system (Also, go to the chapter in this manual explaining the icon(s) selected.).

If the display is in any other menu other than the **MAIN MENU**, use the **Red "LEFT" & Green "RIGHT" Buttons** to select the "PREV" *Icon* and press the **Black "ENTER" Button** to *activate* the **ICON** thus moving back to the previous menu. Do so until **MAIN MENU** appears.

Chapters 2 through 7 will cover all menu items within the **Portals™ Service Menu**. The *Icon* is shown preceding the text. Find the *Icon* in the **Portals™ Service Menu** by navigating with the **Red or Green Buttons**. Each chapter started is from the **MAIN MENU**. Within the chapter, and Sub-Menu will be covered sequentially with their explanation & function. If the operator "gets lost", select and *activate* the "PREV" *Icon* until the display indicates **MAIN MENU**. For more help on Button Usage, select & *activate* the "HELP" *Icon* or "?" *Mini-Icons*.



EXPLANATION & USAGE OF COMMON LARGE & MINI-ICONS USED IN VARIOUS MENUS & SUB-MENUS:

 MORE MORE	 PREV	 QUIT	 HELP	 DECREMENT (-) or INCREMENT (+) displayed value or select previous / next.	 RUN (or activate) selected test or coil PULSE coil.	 View the schematic (DRAWing) of current display. Select while current switch, lamp or coil is viewed.
<p><small>These non-selectable icons appear in the selected Menu only when there are MORE icons to the LEFT or to the RIGHT available for selection.</small></p>	<p><small>Select and activate to return to the PREVIOUS Menu.</small></p>	<p><small>Select and activate to QUIT, exits & returns to the Attract Mode.</small></p>	<p><small>Select and activate to view HELP Screens of the current Menu*.</small></p>	<p><small>Select and activate to: Move LEFT or RIGHT, select previous / next or move backwards / forwards.</small></p>		
<p><small>* Help Note: An explanation of each Mini-Icon at that menu level will cycle continuously. To exit a display where no Mini-Icons are available for selection, pressing any button will exit the display.</small></p>						

Sec. 3: ...Menu Intro.

Example:

After entering **Portals™**, the **MAIN MENU** now appears with the "DIAG" *Icon* (**GO TO DIAGNOSTICS MENU**) flashing:



Press the **Black "ENTER" Button** to *activate* this **ICON**. The **DIAGNOSTICS MENU** now appears with the "SW" *Icon* (**GO TO SWITCH MENU**) flashing:

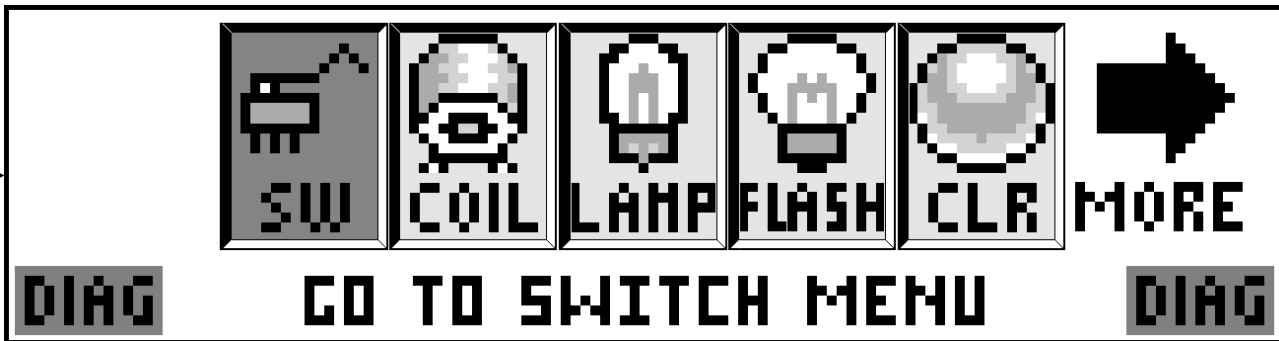

Press the **Black Button** to *activate* this **ICON**. The **SWITCH TEST MENU** now appears with the "TEST" *Icon* (**SWITCH TEST**) flashing:

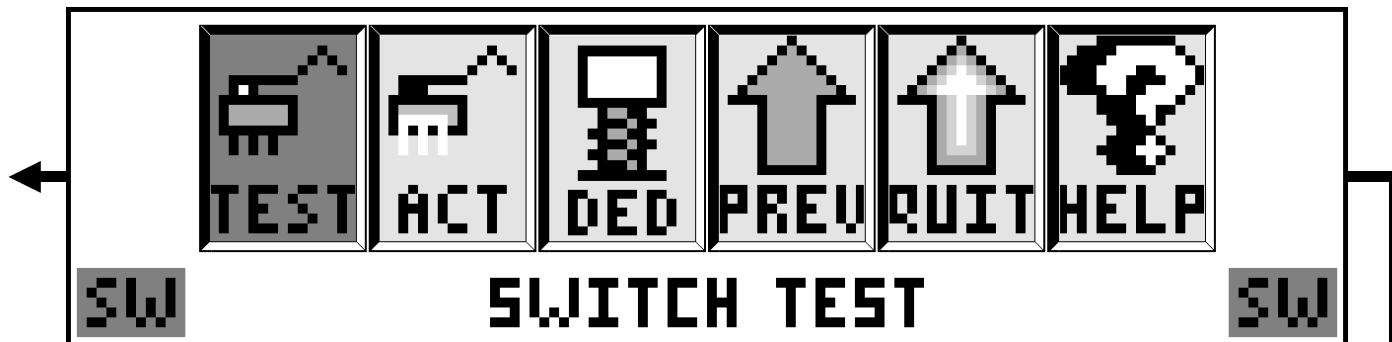

Press the **Black "ENTER" Button** to *activate* this icon. The **Switch Test Display** now appears.

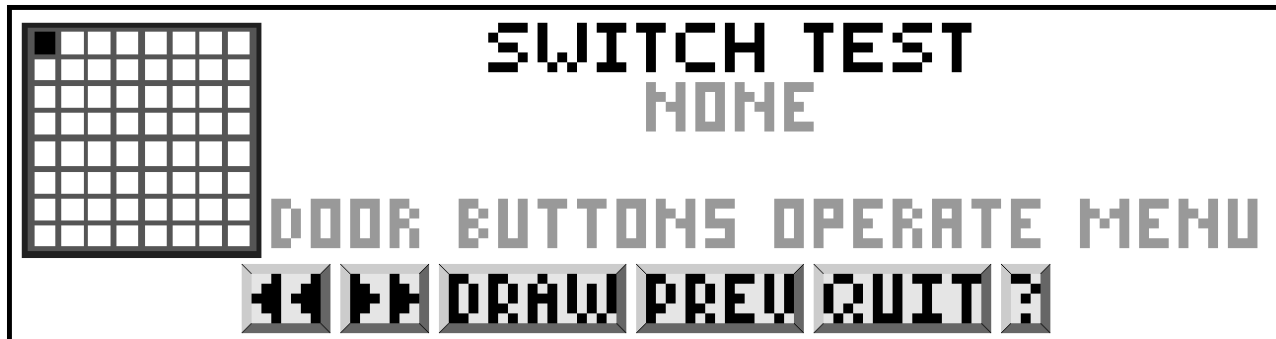

All switches can be tested one at a time. When possible, use a pinball to close any playfield switches; rolling the ball at Stand-Up Targets or over/under switches is suggested. Use finger for all non-playfield switches. As each switch is closed, the respective Switch Matrix Grid Position (1-64) will be lit.

To view the schematic for the switch selected, press either the **Red** or **Green Button** to select the "DRAW" *Mini-Icon*. Press the **Black Button** to *activate* this *Mini-Icon*; do so while the switch is momentarily closed. This will bring up the **Switch Schematic Display**. The display describes the switch in the Switch Matrix which includes the name of the switch, the Return (Row) Wire and the Drive (Column) Wire, drive transistor, and the "Pin-Outs" from the CPU/Sound Board. *Activating* the "DRAW" *Icon* when a switch is not closed, will give the generic switch schematic as shown below.

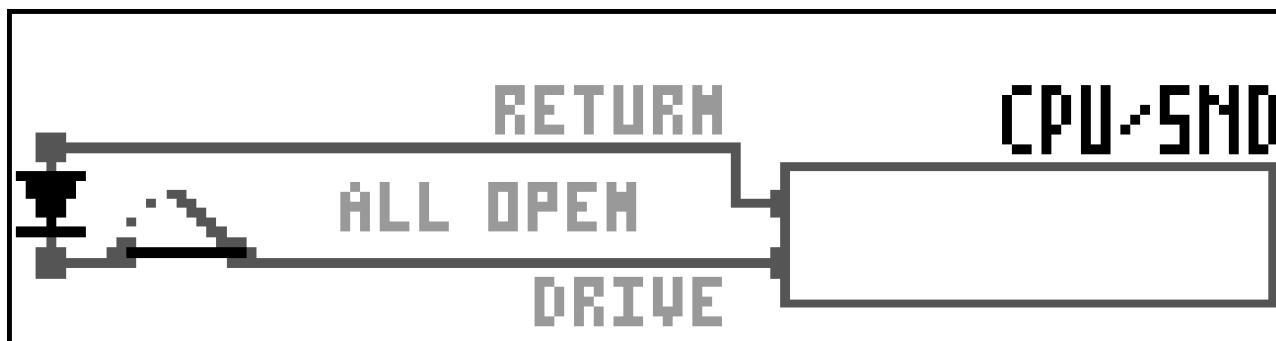

To **exit any display where there are no Mini-Icons** (Schematics or Help Displays), **press any button** to return to the previous Menu.

While in **Switch Test** or **Active Switch Test**, the **Flipper & Start Buttons** are deactivated (because they can be part of these tests). Use the **Red "LEFT," Green "RIGHT"** and/or **Black "ENTER" Buttons** to select and *activate* the "**MINI-ICONS**" at the bottom of the display. In **Switch Test**, if the "<<" or ">>" *Mini-Icon* is *activated*, the display will go to (slip between) the previous tests (*Active & Dedicated Switch Tests*). Use either the **Red** or **Green Button** to select the "PREV" *Mini-Icon*. Press the **Black "ENTER" Button** to return to **Switch Test Menu**. To exit out of this Sub-Menu, select and *activate* the "PREV" *Icon* in the Menu. The **DIAGNOSTICS MENU** now appears with the "SW" *Icon* (**GO TO SWITCH MENU**) flashing. Go through other **Diagnositics** selections or exit.

To exit the **Portals™ Service Menu**, select & *activate* the "QUIT" *Icon* (see the next page).





QUIT THIS SESSION (Exiting the Portals™ Service Menu)

In the **MAIN MENU** and in all **SUB-MENUS**, if the "QUIT" *Icon* or "QUIT" *Mini-Icon* is selected and *activated*, the **Portals™ Service Menu Session** will be exited and returned to the **Attract Mode**.

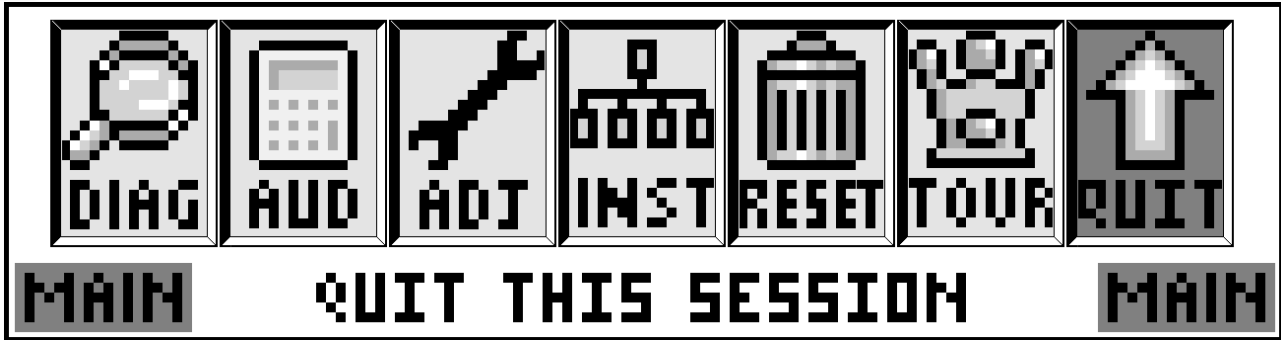

Exiting **Portals™** or turning game on/off will start the *Power-Up Routine*. Upon **Power-Up**, **HOLD IN THE RIGHT FLIPPER BUTTON** to *view* the CPU Game & Display Code Versions (+ Check-Sums), followed by the Location & Game ID Numbers and Alerts, if any (see *Sec. 3, Chp. 2, GO TO DIAGNOSTICS MENU, Technician Alerts*).



The below **Problem / Solution Table** was designed to answer some common problems frequently asked.

Problem / Solution Table

Sec. 3: ...Menu Intro.

PROBLEM	SOLUTION
Will not enter the Service Mode after depressing the Black "BEGIN TEST" Button .	<ul style="list-style-type: none"> Check the Service Switch(es) (Red, Green & Black Buttons) for loose connections or bad Ground. Check the associated wiring harness to/from the CPU/Sound Board, Connector CN6. Check CPU/Sound Board for possible failure.
All Service Buttons (Red, Green and Black) appear nonfunctional.	<ul style="list-style-type: none"> Check the Service Switches wiring harness for poor or no connection and/or broken wires.
The Green Service Button in the Attract Mode will not enter the SERVICE CREDITS MENU to add Service Credits.	<ul style="list-style-type: none"> Check to make sure the Game is not in "Free Play." <i>If the game is set to Free Play, adding Service Credits is not required.</i> Check the Service Switches wiring harness for poor or no connection and/or broken wires.
The Display "blanks out."	<ul style="list-style-type: none"> Check the Dot Matrix Display for loose wiring harness for poor or no connection and/or broken wires. Check F1 (3/4A Fuse) on the Display Power Supply Board. Refer to Section 5, Chapter 4, SCHEMATICS & TROUBLESHOOTING.
Icons " <i>scroll</i> " along continuously in the MAIN MENU .	<ul style="list-style-type: none"> Check for a stuck switch on the Green Button. If the Service Switch Set and/or the Coin Door was replaced, ensure the Locking Mechanism on the Green Button was removed. If the Green Button "clicks" and locks into an up/down position, the Green Button has this lock switch. Remove it. (Ref. to Svc. Bulletin #74.)
The Start and Flipper Buttons do not select or activate <i>Icons</i> in the SWITCH TEST MENU .	<ul style="list-style-type: none"> This is normal. These switches are deactivated, as they are a part of the Switch Test. Use the Red "LEFT" or Green "RIGHT" & Black "ENTER" Buttons in this Sub-Menu. Refer to Section 3, Chapter 2, GO TO DIAGNOSTICS MENU, Switch Test.
Can't move selection of <i>Icon</i> with the Left and/or Right Flipper Buttons .	<ul style="list-style-type: none"> Check the Flipper Buttons for loose connections or bad Ground and refer to Section 5, Chapter 2, Playfield Wiring, #-Flipper Circuit Wiring Diagram. This is normal <i>only</i> in Diagnostic's Switch & Active Switch Tests (see <i>previous Problem</i>).
Some <i>Icons</i> appear non-functional in the PRINTER MENU(S) .	<ul style="list-style-type: none"> If no printing equipment is connected, the "-" Icon, "+" Icon and "RUN" Icon will appear not to function. Refer Section 3, Chapter 3, GO TO PRINTER MENU.
Some <i>Icons</i> appear non-functional in the GAME SPECIFIC MENU under the DIAGNOSTICS MENU .	<ul style="list-style-type: none"> If there is no other test under this Menu, the "<<" & ">>" Mini-Icons will appear not to function. The remaining <i>Icons</i> should function as normal. Note: <i>If there is no "Go To (Game Name) Test(s), the "GAME NAME" Icon will not invoke another display.</i>
The display returns to the ATTRACT MODE exiting the Service Session after a FACTORY RESET .	<ul style="list-style-type: none"> This is normal. After a FACTORY RESET, the Service Session is automatically exited. Refer to Section 3, Chapter 6, GO TO RESET MENU, Factory Reset.
In COIL TEST MENU , the coils and flashlamps <i>do not</i> fire after activating the "RUN" Icon .	<ul style="list-style-type: none"> Ensure the POWER INTERLOCK SWITCH is pulled out (see the start of this Chapter).
In ADJUSTMENTS MENU , with the Coin Door CLOSED , adjustments are not getting changed as desired (using the Flipper & Start Buttons).	<ul style="list-style-type: none"> This is normal. The Memory Protect Switch is enabled when the Coin Door is CLOSED. Changes can be made with the Coin Door OPEN only.
In Portals™ Service Menu , the volume cannot be adjusted with the Red or Green Buttons .	<ul style="list-style-type: none"> The Volume adjustment can only be made when in the Attract Mode. The Volume Mode is entered by pressing the Red "VOLUME" Button. Then use the Red "LEFT" Button to decrease / decrement (-) or Green "RIGHT" Button to increase / increment (+) the volume.
In Portals™ Service Menu , the display seems to lock up, or the Help Display appears to be non-functional.	<ul style="list-style-type: none"> If you cannot clear the situation by exiting back one Menu, exit completely out of the Portals™ Service Menu, and re-enter. If the problem persists, call Technical Support for additional help.



Go To Diagnostics Menu

Overview

The **Portals™ Service Menu System** provides tests for sounds, display, lamps, switches and coils. Each feature may be tested manually or automatically after entering the **Portals™ Service Menu** (see Chapter 1 of this Section). The automatic tests (e.g. **Cycling Coils**, **Test Flash Lamps**) may be used for a quick verification of automatic test functions and the manual tests (**Begin Play Test**, **Single Lamp / All / Row / Column Tests**, and **'Game Name' Tests**) may be used for troubleshooting. All *Icons* and their usages are explained throughout this chapter in order.

Important: Upon **Power-Up** (Game Reset) or opening the **Coin Door** watch the **Display** for any **Alerts**.*



If this **display flashes**, the game is indicating that **CMOS RAM** memory (CPU Loc. U212) has been corrupted. This is caused by either failure in memory (e.g. **batteries are dead and/or faulty RAM**) or upon installation of updated version of game code. Opening the **Coin Door** will initiate a **Factory Restore (Reset)**, by opening the **Memory Protect Switch**.

Check battery voltage at **VBATT Test Point** on the **CPU/Sound Bd.** (more details in Sec. 5, Chp. 4, **PCBs**).



This **flashing display** is shown immediately upon opening the **Coin Door** as a reminder that **20v/50v DC** power to the playfield is **disabled**. All electro-mechanical devices (such as **Coils**) **cannot be tested** with the switch pushed in. **PULL OUT** the **Power Interlock Switch ONLY** if you're in a **Testing Menu** requiring power. See **Access & Use** in Chapter 1 of this Section for the location of this switch. **Closing the Coin Door** will automatically reset this switch.



This **display** is shown momentarily during **Game Mode** or **Power-Up** to alert the operator of a coil malfunction (*coil doesn't energize or coil fires a multiple number of times*). **OPERATOR ALERT!** works by monitoring any **switch activated coil** that has the potential to trap a ball when disabled (more details in this Chapter, **Technician Alerts, Pages 24-25**).











* If this **Tech Report Alert flashes** (along with an audible sound), the game has detected faulty switches and/or missing pinballs. Select the **"TECH"** *Icon* for information (review **Technician Alerts, Pages 24-25**). * For this **Alert display** to appear, **Standard Adj. 49, must be changed to POWERUP, COIN DOOR or POWERUP AND COIN DOOR**, the default is **NEVER** (review Section 3, Chp. 4, **GO TO ADJUSTMENTS MENU, Standard Adjustments, Page 44**).

CAUTION: Remove all pinballs from the Ball Trough prior to lifting the playfield to its full upright position for servicing. **PULL OUT** the **Power Interlock Switch** for operation. To eject pinballs, select the **"DIAG"** *Icon* from the **MAIN MENU** to go to the **DIAGNOSTICS MENU**, then select the **"CLR"** *Icon* to enter the **CLEAR BALL TROUGH MENU**. Select the **"RUN"** *Mini-Icon* and press the **Black "ENTER" Button** or **Start Button** to remove one pinball at a time (this feature also useful to retrieve a pinball for game testing in **Begin Play Test & Game Specific Tests**).



EXPLANATION & USAGE OF COMMON LARGE & MINI-ICONS USED IN VARIOUS MENUS & SUB-MENUS:

Select and activate to:

							
MORE MORE	PREU	RUIT	HELP	DECR INCR	RUN	PULSE	DRAW
These non-selectable icons appear in the selected Menu only when there are MORE icons to the LEFT or to the RIGHT available for selection.	Select and activate to return to the PREVIOUS Menu.	Select and activate to QUIT , exits & returns to the Attract Mode .	Select and activate to view HELP Screens of the current Menu*.	Move LEFT or RIGHT , select previous / next or move backwards / forwards.	DECREMENT (-) or INCREMENT (+) displayed value or select previous / next.	RUN (or activate) selected test or coil PULSE coil.	View the schematic (DRAW ing) of current display. Select while current switch, lamp or coil is viewed.

* **Help Note:** An explanation of each **Mini-Icon** at that menu level will cycle continuously. To exit a display where no **Mini-Icons** are available for selection, pressing any button will exit the display.

GO TO DIAGNOSTICS MENU

After entering **Portals™**, the **MAIN MENU** now appears. To initiate, from the **MAIN MENU**, select the **"DIAG"** *Icon* with either the **Red "LEFT"** or **Green "RIGHT"** **Buttons** (the **Flipper Buttons** operates in the same manner) and press the **Black "ENTER" Button** (the **Start Button** operates in the same manner). The **DIAGNOSTICS MENU** appears. Continue through this chapter for the explanation & usage of the *Icons* in the **DIAGNOSTICS MENU**. **Usage Note:** Only in **Switch & Active Switch Tests**, the **Flipper & Start Buttons cannot be used** as the alternate navigation buttons as they are a part of these tests. After exiting these tests, the **Left & Right Flipper** and **Start Buttons** can once again be used. Continue through this chapter for the explanation & usage of the *Icons* in the **DIAGNOSTICS MENU**.





Go To Switch Menu

To initiate, from the **DIAGNOSTICS MENU**, select the "SW" *Icon* with either the **Red "LEFT"** or **Green "RIGHT"** Buttons and press the **Black "ENTER"** Button. Switches are configured in an 8 x 8 Matrix of Columns (Switch Drives) and Rows (Switch Returns) with up to **64** possible switches. The **SWITCH TEST MENU** consists of three (3) parts: **Switch Test, Active Switches & Dedicated Switch Test**. **Reminder: The Flipper & Start Buttons (part of Switch Tests) cannot be used as navigation buttons during these test(s)**



Switch Test

To initiate, from the **SWITCH MENU**, select the "TEST" *Icon* with either the **Red or Green Buttons** & press the **Black Button**. In **Switch Test**, close each switch and observe the display. The display will describe the switch in the Switch Matrix Grid (*below*), which includes the switch name, Return (Row) Wire, Drive (Column) Wire and the "Pin-Outs" from the **CPU/Sound Board**. When the switch is closed, the information is displayed momentarily. To view the schematic for the switch selected, press either the **Red or Green Button** to select the "DRAW" *Mini-Icon*. Press the **Black Button** to *activate* this *Mini-Icon*; do so while the switch is momentarily closed. To return to **Switch Test**, press the **Black Button** again.



Active Switch Test

To initiate, from the **SWITCH MENU**, select the "ACT" *Icon* with either the **Red or Green Buttons** & press the **Black Button**. If still in a previous test, select the "PREV" *Mini-Icon* to return to **SWITCH MENU** or select either of the "<<" or ">>" *Mini-Icons* to move through the tests. In **Active Switch Test**, if any switches are stuck closed (*or made from the presence of a pinball*), the display sequences through the Switch Names, Return (Row) Wire, Drive (Column) Wire, Drive Transistor, Part Number and the "Pin-Outs" from the **CPU/Sound Board**. This cycle continues until all switches are cleared or until the test is exited.



Dedicated Switch Test

To initiate, from the **SWITCH MENU**, select the "DED" *Icon* with either **Flipper Button** & press the **Start Button** (*the Service Switches are deactivated during this test.*). In **Dedicated Switch Test**, the display will describe the switch which includes the Switch Name, Return (Row) Wire, Drive (Column) Wire, Part Number and the "Pin-Outs" from the **CPU/Sound Board**.

SWITCH MATRIX GRID & DEDICATED SWITCHES

Column (Drive)	1: Q1	2: Q2	3: Q3	4: Q4	5: Q5	6: Q6	7: Q7	8: Q8
Row (Return)	GRN-BRN CN5-P1	GRN-RED CN5-P3	GRN-ORG CN5-P4	GRN-YEL CN5-P5	GRN-BLK CN5-P6	GRN-BLU CN5-P7	GRN-VIO CN5-P8	GRN-GRY CN5-P9
1: U400	1 Cabinet Side WHT-BRN CN7-P9 Sw. Part Number: 180-5160-00	9 Below P/F LT BUTTON (UK ONLY) LEFT VUK Sw. Part Number: 180-5119-01	17 Above P/F SWORD LOCK HIGH Sw. Part Number: 180-5119-02	25 Above P/F RIGHT RAMP ENTER Sw. Part Number: 180-5010-01	33 Mini-P/F MINI PF U.L. Sw. Part Number: 180-5057-00	41 Below P/F TOP VUK Sw. Part Number: See Sw. 41 Note	49 Below P/F LEFT BUMPER Sw. Part Number: 180-5015-03	57 Below P/F LEFT OUTLANE Sw. Part Number: 500-6227-02
2: U400	2 Coin Door WHT-RED CN7-P8 Sw. Part Number: 180-5204-00	10 Below P/F 4TH COIN SLOT STANDUP Sw. Part Number: 515-6027-08	18 Above P/F SWORD LOCK MID Sw. Part Number: 180-5119-02	26 NOT USED	34 Mini-P/F MINI PF U.R. Sw. Part Number: 180-5057-00	42 Above P/F INNER LOOP Sw. Part Number: 180-5190-28	50 Below P/F RIGHT BUMPER Sw. Part Number: 180-5015-03	58 Below P/F LEFT RETURN LANE Sw. Part Number: 500-6227-02
3: U400	3 Coin Door WHT-ORG CN7-P7 Sw. Part Number: Future Use	11 Below P/F 6TH COIN SLOT Sw. Part Number: Future Use	19 Above P/F 4-BALL TROUGH #1 (LEFT) SWORD LOCK LOW Sw. Part Number: 180-5119-02	27 NOT USED	35 Mini-P/F MINI PF L.L. Sw. Part Number: 180-5057-00	43 Below P/F LEFT TOP LANE Sw. Part Number: 500-6227-02	51 Below P/F BOTTOM BUMPER Sw. Part Number: 180-5015-03	59 Below P/F LEFT SLINGSHOT Sw. Part Number: 180-5054-00 (x2)
4: U400	4 Coin Door WHT-YEL CN7-P6 Sw. Part Number: 180-5204-00	12 Below P/F RIGHT COIN SLOT 4-BALL TROUGH #2 Sw. Part Number: 180-5119-02	20 Below P/F RIGHT ORBIT LOW Sw. Part Number: 500-6227-02	28 Above P/F BALROG HIT Sw. Part Number: 180-5119-00	36 Mini-P/F MINI PF L.R. Sw. Part Number: 180-5057-00	44 Below P/F MIDDLE TOP LANE Sw. Part Number: 500-6227-02	52 Above P/F SPINNER Sw. Part Number: 180-5190-28	60 Below P/F RIGHT OUTLANE Sw. Part Number: 500-6227-02
5: U401	5 Coin Door WHT-GRN CN7-P5 Sw. Part Number: 180-5204-00	13 Below P/F CENTER COIN SLOT / DBA 4-BALL TROUGH #3 Sw. Part Number: 180-5119-02	21 Above P/F RIGHT ORBIT HI Sw. Part Number: 180-5190-28	29 Below P/F PALANTIR Sw. Part Number: 515-5162-08	37 Below P/F LEFT ORBIT LOW Sw. Part Number: 500-6227-02	45 Below P/F RIGHT TOP LANE Sw. Part Number: 500-6227-02	53 Below P/F SPOT RING Sw. Part Number: 515-5162-08	61 Below P/F RIGHT RETURN LANE Sw. Part Number: 500-6227-02
6: U401	6 Coin Door WHT-BLU CN7-P3 Sw. Part Number: 180-5204-00	14 Above P/F LEFT COIN SLOT 4-BALL TROUGH VUK OPTO Sw. Part Number: See Sw. 14 Note	22 Above P/F RAIL RAMP EXIT Sw. Part Number: 180-5197-00	30 Below P/F RIGHT VUK Sw. Part Number: 180-5116-01	38 Below P/F LEFT ORBIT HI Sw. Part Number: 500-6227-02	46 Below P/F TOP SAUCER Sw. Part Number: 180-5186-00	54 In Cabinet START BUTTON Sw. Part Number: 180-5174-00	62 Below P/F RIGHT SLINGSHOT Sw. Part Number: 180-5054-00 (x2)
7: U401	7 Coin Door WHT-VIO CN7-P2 Sw. Part Number: Future Use	15 Below P/F 5TH COIN SLOT 4-BALL STACKING OPTO Sw. Part Number: Future Use	23 Above P/F RIGHT RAMP TARGET Sw. Part Number: 515-6027-08	31 Below P/F BALROG OPEN Sw. Part Number: 180-5119-02	39 Below P/F LEFT RAMP ENTER Sw. Part Number: 500-6227-02	47 Back Panel RING MADE Sw. Part Number: See Sw. 47 Note	55 In Cabinet TOURNAMENT START Sw. Part Number: 180-5174-00	63 NOT USED
8: U401	8 Cabinet Side WHT-GRY CN7-P1 Sw. Part Number: 180-5160-00	16 Below P/F RT BUTTON (UK ONLY) SHOOTER LANE Sw. Part Number: 180-5157-00	24 Above P/F RIGHT RAMP MADE Sw. Part Number: 180-5198-00	32 Below P/F BALROG CLOSED Sw. Part Number: 180-5119-02	40 Above P/F LEFT RAMP MADE Sw. Part Number: 180-5010-01	48 Back Panel BACK TROUGH Sw. Part Number: 180-5057-00	56 In Cabinet PLUMB BOB TILT Sw. Part Number: See Sw. 56 Note	64 NOT USED

GROUND	GROUND
1: U206 GRY-BRN CN6-P2 Sw. Part Number: 180-5160-00	DS-1 on Cabinet Side #1 LEFT FLIPPER BUTTON Sw. Part Number: 180-5160-00
2: U206 GRY-RED CN6-P3 Sw. Part Number: 180-5149-00 on Flipper	DS-2 Below Playfield #2 LEFT FLIPPER E.O.S (End-of-Stroke) Sw. Part Number: 180-5149-00 on Flipper
3: U206 GRY-ORG CN6-P4 Sw. Part Number: 180-5160-00	DS-3 on Cabinet Side #3 RIGHT FLIPPER BUTTON Sw. Part Number: 180-5160-00
4: U206 GRY-YEL CN6-P6 Sw. Part Number: 180-5149-00 on Flipper	DS-4 Below Playfield #4 RIGHT FLIPPER E.O.S (End-of-Stroke) Sw. Part Number: 180-5149-00 on Flipper
5: U206 GRY-GRN CN6-P7 Sw. Part Number:	DS-5 NOT USED
6: U206 GRY-BLU CN6-P8 Sw. Part Number:	DS-6 on Coin Door #6 VOLUME (RED BUTTON) (In Test: LEFT) Sw. Part Number: 180-5192-02
7: U206 GRY-VIO CN6-P9 Sw. Part Number:	DS-7 on Coin Door #7 SERV. CRED. (GREEN BUTTON) (In Test: RIGHT) Sw. Part Number: 180-5192-02
8: U206 GRY-BLK CN6-P10 Sw. Part Number:	DS-8 on Coin Door #8 BEGIN TEST (BLACK BUTTON) (In Test: ENTER) Sw. Part Number: 180-5192-00

Sec. 3: ... Diagnostics



SWITCH MATRIX GRID LOCATIONS

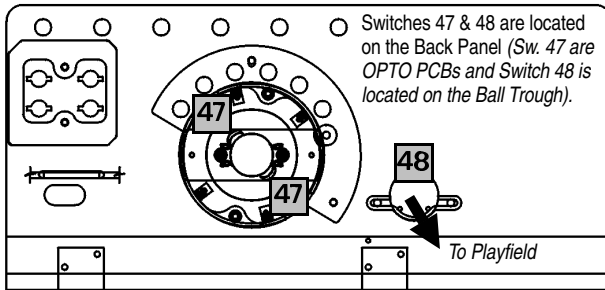

◀ Backpanel ▼

Mini-Upper Playfield ▶ shown moved off the Main Playfield for clarity.

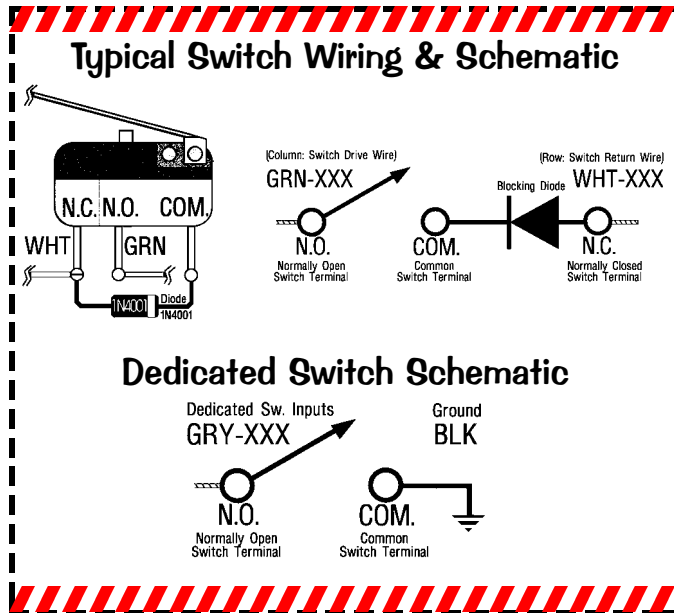

◻ = Switches above Playfield. ◼ = Switches below Playfield.
◐ = Switches not on Playfield.

Switch Part Notes: ¥ Yen Coin Switch is 180-5091-00. Part Numbers which start with 515- or 500- include the bracket, target, and/or housing.

Sw. 14, 15, 41 & 47 Part Note: OPTO PC Boards are used as Switches:
Trans.: 515-0173-00 (Sw. 14 & 15); Receiver: 515-0174-00 (Sw. 14 & 15);
Transmitter 515-7307-00 (Sw. 41); Rec. 515-7308-00 (Sw. 41);
Transmitter 500-6746-00 (Sw. 47); Receiver 500-6747-00 (Sw. 47);

Sw. 56 Part Note: The Switch is comprised of a Hanger Bracket (535-5319-00) and Contact Wire (535-7563-01) located in the Cabinet.

Some Switch Diodes may be located under the playfield, in the Cabinet or Backbox on Terminal Strips or Diode Boards and not on the assemblies. DOTS: D iode O n I erminal S trip, see Section 5, Chapter 2, Playfield Wiring.

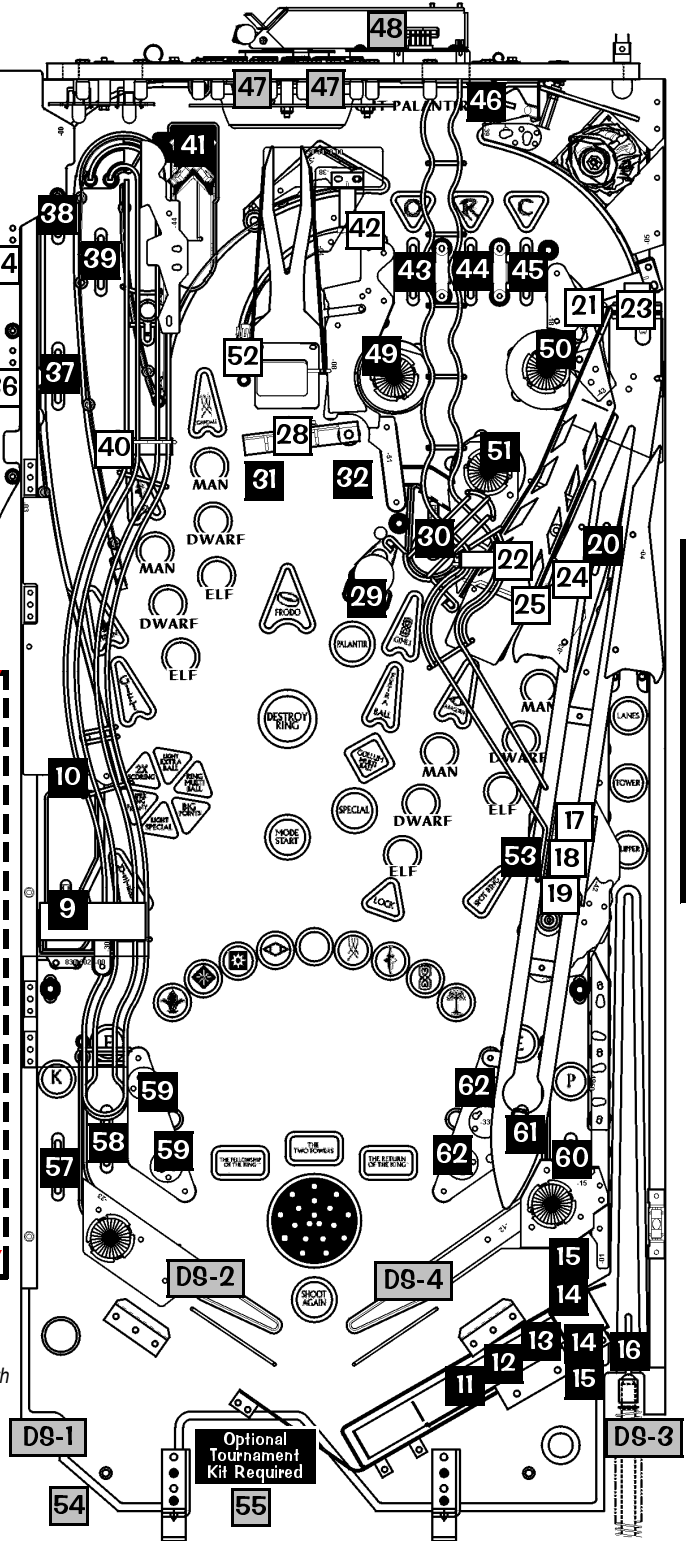

Sec. 3: ... Diagnostics

Go To
Diagnostics Menu





Go To Coil Menu

To initiate, from the **DIAGNOSTICS MENU**, select the "COIL" *Icon* with either the **Red "LEFT"** or **Green "RIGHT" Buttons** and press the **Black "ENTER" Button**. The coils are listed in groups. Coils **01-16** are typically High Current Coils (*although Low Current Coils may be used in these positions & will be noted*). Coils **17-32** are typically Low Current Coils. Flash Lamps are typically used in positions **25-32** (*although may be used in any position & will be noted*).



PULL OUT the Power Interlock Switch for operation with the Coin Door open.

Important: The Partial Coils Detailed Chart Table is used as a reference against the Coil & Flash Lamp Locations on the next page. For the **complete** Coils Detailed Chart Table, see the reverse of the following page. The Chart is shown to compare against the Backbox I/O Power Driver Board Detailed Wiring Diagram (shown again in Sec. 5, Chapter 1, **Playfield Wiring**). For more on troubleshooting and diagnosing, see Sec. 5, Chapter 4, **Printed Circuit Boards**.



Single Coil Test

To initiate, from the **COIL MENU**, select the "TEST" *Icon* with either the **Red or Green Buttons** and press the **Black Button**. Ensure the **Power Interlock Switch** is pulled out. Select either the "-" or "+" *Mini-Icons*. Start with the "+" *Mini-Icon* to start the manual **Single Coil Test** from #1 (*the test runs through all Coils and Flash Lamps #1-#32 & Optional UK Only Auxiliary Positions AUX 1-3*). Press the **Black Button** on the "+" *Mini-Icon*, as each coil is selected, the display will describe the Coil or Flash Lamp Name with the corresponding number, the wire with colors, the "Pin-Outs" from the I/O Power Driver Board, the Coil Voltage and Gauge-Turns (*e.g. 23-800*). Press the **Black Button** again to move forward in the test. To test and view a particular Coil or Flash Lamp, select the "RUN" *Mini-Icon* and press the **Black Button**. Each time the **Black Button** is pushed, the Coil or Flash Lamp will fire on the Playfield and/or Backbox, with the display indicating the Coil or Flash Lamp information. Continue with the same procedure to run through the entire test.



Cycling Coil Test

To initiate, from the **COIL MENU**, select the "CYC" *Icon* with either the **Red or Green Buttons** and press the **Black Button**. If still in a previous test, select the "PREV" *Mini-Icon* to return to **COIL MENU** or select either of the "<<" or ">>" *Mini-Icons* to move to **Cycling Coil Test** (*selecting again will return to Coil Test*). The test pulses each regular Coil or Flash Lamp sequentially (*cycling*) on the Playfield and in the Backbox (*if Coils are used*). The display indicates **CYCLING COILS**.

⊖ **Coil Note:** ⊖ Either -00B or -00T can be used for coil replacements. *B/T listed is preferable for easier diode access & may differ on game.*

PARTIAL COILS DETAILED CHART ...

High Current Coils Group 1		Drive Transistor	Coil GA-Turn or Bulb Type
#1	TROUGH UP-KICKER	Q1	26-1200 ⊖ 090-5044-00T
#2	AUTO LAUNCH	Q2	24-940 ⊖ 090-5036-00T
#3	LEFT VUK	Q3	26-1200 ⊖ 090-5044-00B
#4	TOP VUK	Q4	26-1200 ⊖ 090-5044-00B
#5	RIGHT VUK	Q5	26-1200 ⊖ 090-5044-00B
#6	RING MAGNET	Q6	20½-480 ⊖ 090-5064-02
#7	RIGHT TOWER	Q7	23-800 090-5001-NL
#8	LOOP DIVERTER	Q8	22-1080 ⊖ 090-5032-00T
Diode On Terminal Strip (if noted)			
High Current Coils Group 2		Drive Transistor	Coil GA-Turn or Bulb Type
#9	LEFT BUMPER	Q9	26-1200 ⊖ 090-5044-00T
#10	RIGHT BUMPER	Q10	26-1200 ⊖ 090-5044-00T
#11	BOTTOM BUMPER	Q11	26-1200 ⊖ 090-5044-00T
#12	NOT USED	Q12	
#13	ORBIT PIN	Q13	26-1200 ⊖ 090-5044-00B
#14	FLASH: HELMS DEEP RT	Q14	#906 Bulb 165-5004-00
#15	LEFT FLIPPER (50v RED/YEL)	Q15	22-900 ⊖ 090-5020-20T
#16	RIGHT FLIPPER (50v RED/YEL)	Q16	22-900 ⊖ 090-5020-20T
Low Current Coils Group 1		Drive Transistor	Coil GA-Turn or Bulb Type
#17	LEFT SLINGSHOT	Q17	23-800 ⊖ 090-5001-00T
#18	RIGHT SLINGSHOT	Q18	23-800 ⊖ 090-5001-00T
#19	TOP SAUCER	Q19	26-1200 ⊖ 090-5044-00B
#20	BALROG MOTOR RELAY	Q20	DC Relay 520-5066-00
#21	SWORD LOCK RELEASE	Q21	27-1500 ⊖ 090-5004-00T
#22	BALROG MOTOR	Q22	Motor 041-5088-01
#23	FLASH: HELMS DEEP LT	Q23	#906 Bulb 165-5004-00
#24	OPTIONAL COIL	Q24	Opt. 5v
Low Current Coils Group 2		Drive Transistor	Coil GA-Turn or Bulb Type
#25	FLASH: POPS X3	Q25	#906 Bulb 165-5004-00
#26	FLASH: RING	Q26	#906 Bulb 165-5004-00
#27	FLASH: BACK PANEL	Q27	#906 Bulb 165-5004-00
#28	NOT USED	Q28	
#29	FLASH: RINGWRAITH	Q29	#906 Red 165-5004-02
#30	FLASH: SWORD	Q30	#906 Bulb 165-5004-00
#31	FLASH: DESTROY THE RING	Q31	#89 Bulb 165-5000-89
#32	FLASH: BALROG	Q32	#89 Bulb 165-5000-89
Auxiliary (UK ONLY)		Drive Transistor	Coil GA-Turn
AUX 1: LEFT UP/DOWN POST		Q1	26-1200 ⊖ 090-5044-00T
AUX 2: CENTER UP/DOWN POST		Q2	23-1100 ⊖ 090-5030-00T
AUX 3: RIGHT UP/DOWN POST		Q3	26-1200 ⊖ 090-5044-00T



COIL & FLASH LAMP LOCATIONS

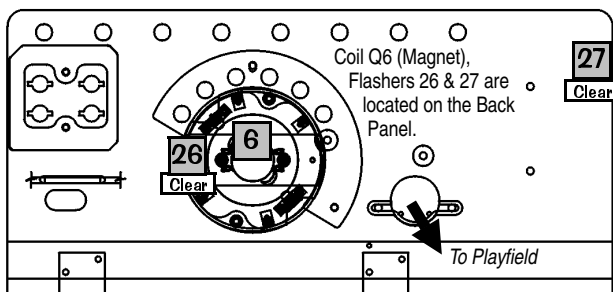

← Backpanel



← Q32
(Flash Lamp)
inside
Balrog.

See Page 87 for
better views.

← Playfield

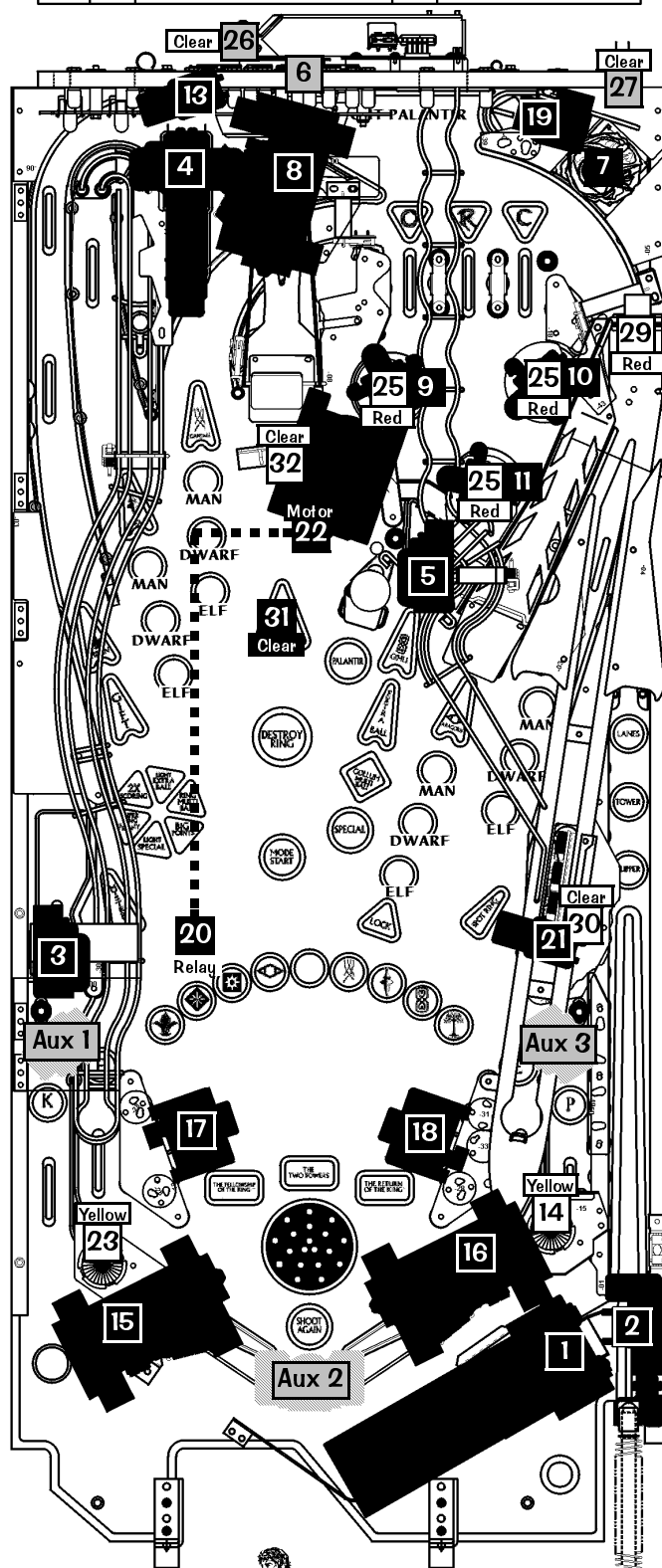

Typical Coil Wiring

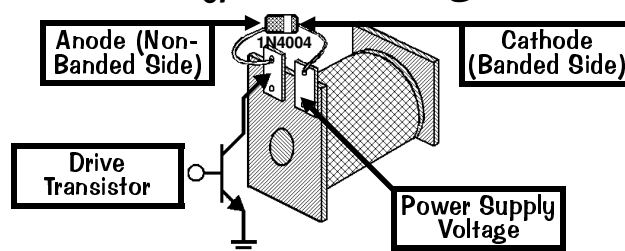

Bulb Types used for Flash Lamps



#89 Bulb
(Bayonet)
165-5000-89



#906 Bulb
(Wedge Base)
165-5004-00

- = Coils / Flash Lamps above Playfield.
- = Coils / Flash Lamps below Playfield.
- = Coils / Flash Lamps not on Playfield.
- Color** = Color of Mini-Mars of Flash Lamp Bulb.

Some Coil or Flash Lamp Diodes may be located under the playfield, in the Cabinet or Backbox on Terminal Strips or Diode Boards and not on the assemblies. DOTS: Diode Qn Terminal Strip See Section 5, Chapter 2, Playfield Wiring.

Coil Q24 is Optional. If either a Coin Meter, Token Dispenser or Knocker (all optional equipment) is required, call Technical Support for more information, 1-800-542-5377 or 1-708-345-7700.

Go To
Diagnostics Menu





In COIL MENU also select:

CYCLING COIL TEST

COILS DETAILED CHART TABLE

High Current Coils Group 1		Drive Transistor	Driver Output Board	Power Line Color	Power Line Connection	Power Voltage	Drive Transistor Control Line Color	D.T. Control Line Connect	Coil GA-Turn or Bulb Type
#1	TROUGH UP-KICKER	Q1	▲ I/O Power Driver ▼	YEL-VIO	J10-P4/5	50v DC	BRN-BLK	J8-P1	26-1200 Ⓞ 090-5044-00T
#2	AUTO LAUNCH	Q2		YEL-VIO	J10-P4/5	50v DC	BRN-RED	J8-P3	24-940 Ⓞ 090-5036-00T
#3	LEFT VUK	Q3		YEL-VIO	J10-P4/5	50v DC	BRN-ORG	J8-P4	26-1200 Ⓞ 090-5044-00B
#4	TOP VUK	Q4		YEL-VIO	J10-P4/5	50v DC	BRN-YEL	J8-P5	26-1200 Ⓞ 090-5044-00B
#5	RIGHT VUK	Q5		YEL-VIO	J10-P4/5	50v DC	BRN-GRN	J8-P6	26-1200 Ⓞ 090-5044-00B
#6	RING MAGNET	Q6		VIO-YEL	J10-P3	50v DC	BRN-BLU	J8-P7	20½-480 Ⓞ 090-5064-02
#7	RIGHT TOWER	Q7		YEL-VIO	J10-P4/5	50v DC	BRN-VIO	J8-P8	23-800 090-5001-NL
#8	LOOP DIVERTER	Q8		GRY-YEL-3A Fuse-YEL-VIO	J10-P1/2	50v DC	BRN-GRY	J8-P9	22-1080 Ⓞ 090-5032-00T
D iode O n Terminal S trip (if noted)									
High Current Coils Group 2		Drive Transistor	Driver Output Board	Power Line Color	Power Line Connection	Power Voltage	Drive Transistor Control Line Color	D.T. Control Line Connect	Coil GA-Turn or Bulb Type
#9	LEFT BUMPER	Q9	▲ I/O Power Driver ▼	YEL-VIO	J10-P4/5	50v DC	BLU-BRN	J9-P1	26-1200 Ⓞ 090-5044-00T
#10	RIGHT BUMPER	Q10		YEL-VIO	J10-P4/5	50v DC	BLU-RED	J9-P2	26-1200 Ⓞ 090-5044-00T
#11	BOTTOM BUMPER	Q11		YEL-VIO	J10-P4/5	50v DC	BLU-ORG	J9-P4	26-1200 Ⓞ 090-5044-00T
#12	NOT USED	Q12					BLU-YEL	J9-P5	
#13	ORBIT PIN	Q13		BRN	J7-P1	20v DC	BLU-GRN	J9-P6	26-1200 Ⓞ 090-5044-00B
#14	FLASH: HELMS DEEP RT	Q14		ORG	J6-P10	50v DC	BLU-BLK	J9-P7	#906 Bulb 165-5004-00
#15	LEFT FLIPPER (50v RED/YEL)	Q15		GRY-YEL-3A Fuse-RED-YEL	J10-P1/2	50v DC	ORG-GRY	J9-P8	22-900 Ⓞ 090-5020-20T
#16	RIGHT FLIPPER (50v RED/YEL)	Q16		BLU-YEL-3A Fuse-RED-YEL	J10-P1/2	50v DC	ORG-VIO	J9-P9	22-900 Ⓞ 090-5020-20T
Low Current Coils Group 1		Drive Transistor	Driver Output Board	Power Line Color	Power Line Connection	Power Voltage	Drive Transistor Control Line Color	D.T. Control Line Connect	Coil GA-Turn or Bulb Type
#17	LEFT SLINGSHOT	Q17	▲ I/O Power Driver ▼	BRN	J7-P1	20v DC	VIO-BRN	J7-P2	23-800 Ⓞ 090-5001-00T
#18	RIGHT SLINGSHOT	Q18		BRN	J7-P1	20v DC	VIO-RED	J7-P3	23-800 Ⓞ 090-5001-00T
#19	TOP SAUCER	Q19		BRN	J7-P1	20v DC	VIO-ORG	J7-P4	26-1200 Ⓞ 090-5044-00B
#20	BALROG MOTOR RELAY	Q20		BRN	J7-P1	20v DC	VIO-YEL	J7-P6	DC Relay 520-5066-00
#21	SWORD LOCK RELEASE	Q21		BRN	J7-P1	20v DC	VIO-GRN	J7-P7	27-1500 Ⓞ 090-5004-00T
#22	BALROG MOTOR	Q22		BRN	J7-P1	20v DC	VIO-BLU	J7-P8	Motor 041-5088-01
#23	FLASH: HELMS DEEP LT	Q23		ORG	J6-P10	20v DC	VIO-BLK	J7-P9	#906 Bulb 165-5004-00
#24	OPTIONAL COIL	Q24		RED	J16-P7	5v DC	VIO-GRY	J7-P10	Opt. 5v
Low Current Coils Group 2		Drive Transistor	Driver Output Board	Power Line Color	Power Line Connection	Power Voltage	Drive Transistor Control Line Color	D.T. Control Line Connect	Coil GA-Turn or Bulb Type
#25	FLASH: POPS X3	Q25	▲ I/O Power Driver ▼	ORG	J6-P10	20v DC	BLK-BRN	J6-P1	#906 Bulb 165-5004-00
#26	FLASH: RING	Q26		ORG	J6-P10	20v DC	BLK-RED	J6-P2	#906 Bulb 165-5004-00
#27	FLASH: BACK PANEL	Q27		ORG	J6-P10	20v DC	BLK-ORG	J6-P3	#906 Bulb 165-5004-00
#28	NOT USED	Q28					BLK-YEL	J6-P4	
#29	FLASH: RINGWRAITH	Q29		ORG	J6-P10	20v DC	BLK-GRN	J6-P5	#906 Red 165-5004-02
#30	FLASH: SWORD	Q30		ORG	J6-P10	20v DC	BLK-BLU	J6-P6	#906 Bulb 165-5004-00
#31	FLASH: DESTROY THE RING	Q31		ORG	J6-P10	20v DC	BLK-VIO	J6-P7	#89 Bulb 165-5000-89
#32	FLASH: BALROG	Q32		ORG	J6-P10	20v DC	BLK-GRY	J6-P8	#89 Bulb 165-5000-89
Note: In Test Flash Lamps Menu ("Flash" Icon), Flashers tested are all Flash Lamps located between Q1-Q32 (This Game: Q14, Q23 & Q25-Q27, Q29-Q32)									
Auxiliary (UK ONLY)		Drive Transistor	Driver Output Board	Power Line Color	Power Line Connection	Power Voltage	Drive Transistor Control Line Color	D.T. Control Line Connect	Coil GA-Turn
AUX 1: LEFT UP/DOWN POST		Q1	UK 3X Trans. Driver Board	BRN	J7-P1	20v DC	WHT	J2-P3	26-1200 Ⓞ 090-5044-00T
AUX 2: CENTER UP/DOWN POST		Q2		BRN	J7-P1	20v DC	RED	J2-P4	23-1100 Ⓞ 090-5030-00T
AUX 3: RIGHT UP/DOWN POST		Q3		BRN	J7-P1	20v DC	ORG	J2-P7	26-1200 Ⓞ 090-5044-00T

Ⓞ Coil Note: Ⓞ Either -00B or -00T can be used for coil replacements. B/T listed is preferable for easier diode access & may differ on game.



Backbox I/O Power Driver Board Detailed Wiring Diagram

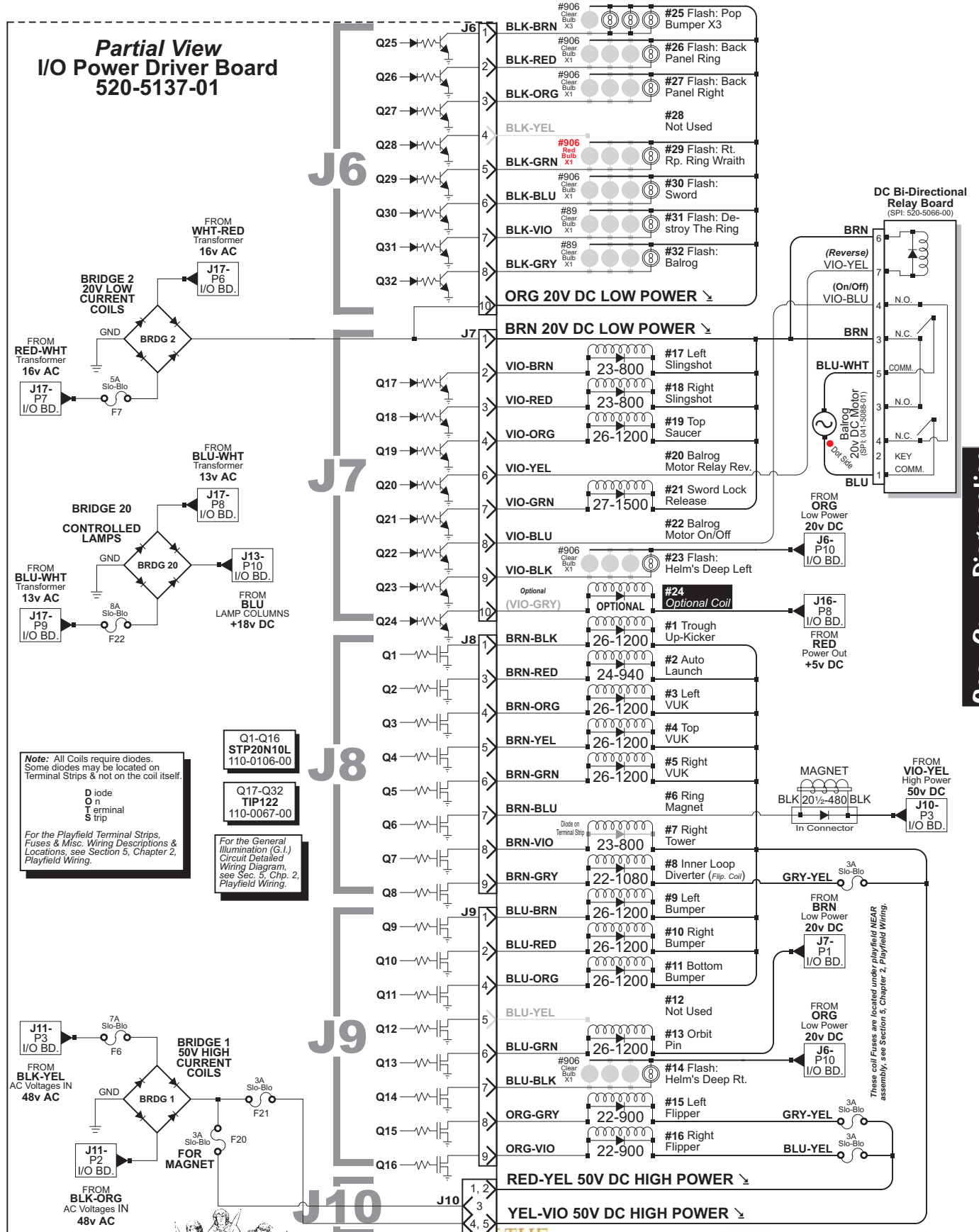

Sec. 3: ... Diagnostics

Go To
Diagnostics Menu



THE LORD OF THE RINGS
 Section 3, Chapter 2
 Page 21



Go To Lamp Menu

To initiate, from the **DIAGNOSTICS MENU**, select the "LAMP" *Icon* with either the **Red "LEFT"** or **Green "RIGHT" Buttons** and press the **Black "ENTER" Button**. Controlled lamps are configured in an 8 x 10 Matrix of Columns (Lamp Drives) and Rows (Lamp Returns) with up to **80 lamps** possible. The Lamp Test Menu consists of four (4) parts: **Single Lamp Test**, **Test All Lamps**, **Row Lamp Test** & **Column Lamp Test**.



Single Lamp Test

To initiate, from the **LAMP MENU**, select the "ONE" *Icon* with either the **Red or Green Buttons** and press the **Black Button**. Select either the "-" or "+" *Mini-Icons*. Start with the "+" *Mini-Icon* to start the manual **Single Lamp Test** from Column 1, Row 1, Switch 1. Press the **Black Button** on the "+" *Mini-Icon*, as each lamp is selected, the lamp will light at its location on the playfield as well as the display, indicating the Lamp Matrix Grid Position (*below*), lamp name with the corresponding number, Return (Row) Wire & Color, Drive (Column) Wire & Color, and associated drive transistors. Press the **Black Button** again to move forward in the test. To test and view a particular lamp, select the "RUN" *Mini-Icon* and press the **Black Button**. Each time the **Black Button** is pushed, the lamp will light-up on the playfield, with the display indicating the lamp information. *Continue with the same procedure to run through the entire test.*



Test All Lamps

To initiate, from the **LAMP MENU**, select the "ALL" *Icon* with either the **Red or Green Buttons** and press the **Black Button**. If still in **Single Lamp Test** (or any 1 of the 4 tests), select the "PREV" *Mini-Icon* to return to **LAMP MENU** or select either of the "<<" or ">>" *Mini-Icons* to move through the tests, keep activating until **Test All Lamps** is displayed. The display will indicate **ALL LAMPS ON** and the lamps on the playfield will be lit, alternating between the rows in the Lamp Matrix Grid.



Row & Column Lamp Tests

To initiate, from the **LAMP MENU**, select the "ROW" or "COL" *Icon* with either the **Red or Green Buttons** and press the **Black Button**. If still in a previous test, select the "PREV" *Mini-Icon* to return to **LAMP MENU** or select either of the "<<" or ">>" *Mini-Icons* to move through the tests, keep activating until **Row** or **Column Lamp Test** (*whichever desired*) is displayed. In this test, each set of lamps in each Row or Column of the Lamp Matrix Grid (*respective to each test*) will light-up on the playfield and is indicated in the display.



Sec. 3: ... Diagnostics

LAMP MATRIX GRID

Column (18v)	1: U17	2: U16	3: U15	4: U14	5: U13	6: U12	7: U11	8: U10
Row (Ground)	YEL-BRN J12-P9	YEL-RED J13-P8	YEL-ORG J13-P7	YEL-BLK J13-P6	YEL-GRN J13-P5	YEL-BLU J13-P4	YEL-VIO J13-P3	YEL-GRY J13-P1
1: Q33	1 #555 Bulb RED-BRN J12-P1 (K) EEP	2 #555 Bulb K (E) EP	3 #555 Bulb KE (E) P	4 #555 Bulb KEE (P)	5 #555 Bulb THE FELLOWSHIP OF THE RING	6 #555 Bulb THE TWO TOWERS	7 #555 Bulb THE RETURN OF THE KING	8 #555 Bulb SHOOT AGAIN
2: Q34	9 #555 Bulb RED-BLK J12-P2 PIPPIN	10 #555 Bulb MERRY	11 #555 Bulb SAM	12 #555 Bulb ARAGORN	13 #555 Bulb FRODO	14 #555 Bulb GANDALF	15 #555 Bulb LEGOLES	16 #555 Bulb GIMLI
3: Q35	17 #555 Bulb RED-ORG J12-P3 BOROMIR	18 #555 Bulb MYSTERY	19 #555 Bulb FRODO ARROW	20 #44 Bulb DESTROY RING	21 #555 Bulb MODE START	22 #555 Bulb PALANTIR	23 #44 Bulb PALANTIR GLOBE	24 #555 Bulb SPOT RING
4: Q36	25 #555 Bulb RED-YEL J12-P4 PIPPIN ARROW	26 #555 Bulb GIFT OF THE ELVES	27 #555 Bulb LIGHT EXTRA BALL	28 #555 Bulb RING MULTIBALL	29 #555 Bulb BIG POINTS	30 #555 Bulb LIGHT SPECIAL	31 #555 Bulb SUPER RING FRENZY	32 #555 Bulb 2X SCORING
5: Q37	33 #555 Bulb RED-GRN J12-P5 LEGOLES ARROW	34 #555 Bulb L RAMP MAN RING	35 #555 Bulb L RAMP DWARF RING	36 #555 Bulb L RAMP ELF RING	37 #555 Bulb GANDALF ARROW	38 #555 Bulb C LOOP MAN RING	39 #555 Bulb C LOOP DWARF RING	40 #555 Bulb C LOOP ELF RING
6: Q38	41 #555 Bulb RED-BLU J12-P6 GIMLI ARROW	42 #555 Bulb EXTRA BALL	43 #555 Bulb GOLLUM MULTIBALL	44 #555 Bulb SPECIAL	45 #555 Bulb MERRY ARROW	46 #555 Bulb R ORBIT MAN RING	47 #555 Bulb R ORBIT DWARF RING	48 #555 Bulb R ORBIT ELF RING
7: Q39	49 #555 Bulb RED-VIO J12-P8 ARAGORN ARROW	50 #555 Bulb R RAMP MAN RING	51 #555 Bulb R RAMP DWARF RING	52 #555 Bulb R RAMP ELF RING	53 #555 Bulb LOCK	54 #555 Bulb LANES	55 #555 Bulb TOWER	56 #555 Bulb FLIPPER
8: Q40	57 #555 Bulb RED-GRY J12-P9 (O) RC	58 #555 Bulb O (R) C	59 #555 Bulb OR (C)	60 #555 Grn. Bulb POTD U.L.	61 #555 Grn. Bulb POTD U.R.	62 #555 Grn. Bulb POTD L.L.	63 #555 Grn. Bulb POTD L.R.	64 #44 Bulb SHOOTER LANE #1 BOT
9: Q41	65 #44 Bulb RED-WHT J12-P10 SHOOTER LANE #2	66 #44 Bulb SHOOTER LANE #3	67 #44 Bulb SHOOTER LANE #4	68 #44 Bulb SHOOTER LANE #5	69 #44 Bulb SHOOTER LANE #6	70 #44 Bulb SHOOTER LANE #7	71 #44 Bulb SHOOTER LANE #8	72 #44 Bulb SHOOTER LANE #9 TOP
10: Q42	73 #44 Bulb RED J12-P11 ESCAPE THE RINGWRAITHS	74 #44 Bulb GANDALF VS SARUMAN	75 #44 Bulb WARG ATTACK	76 #44 Bulb WAR OF THE ENTS	77 #44 Bulb BATTLE WITH SHELOB	78 #44 Bulb DESTROY THE WITCH-KING	79 #555 Bulb TOURNAMENT BUTTON	80 #555 Bulb START BUTTON



LAMP MATRIX GRID LOCATIONS

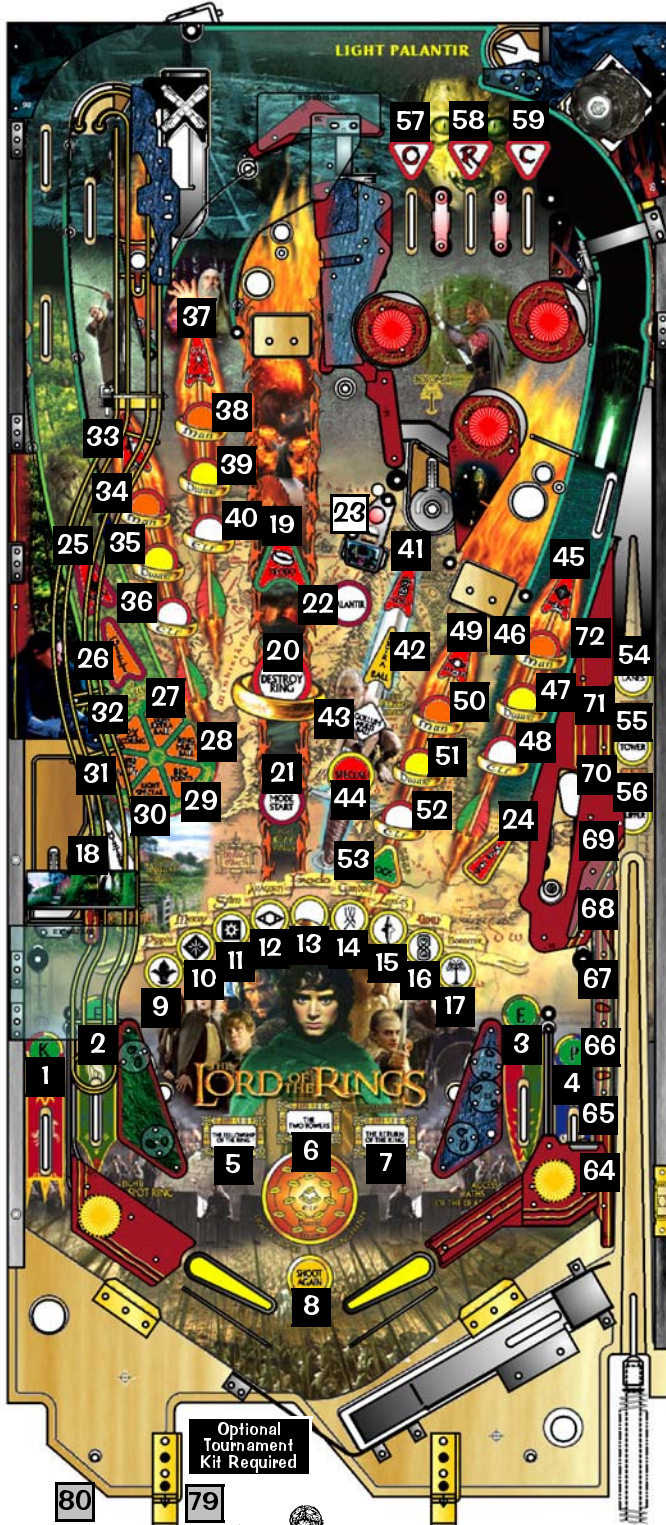
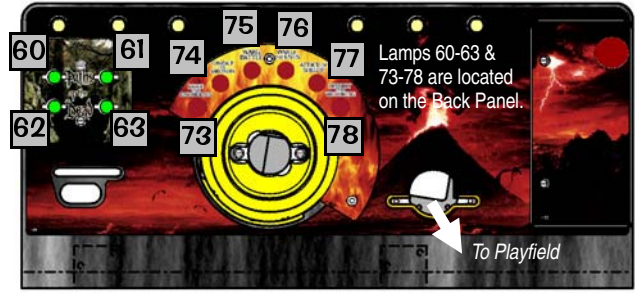
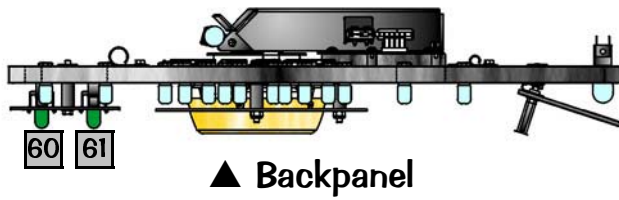

◀ Playfield

Typical Lamp Wiring & Schematic

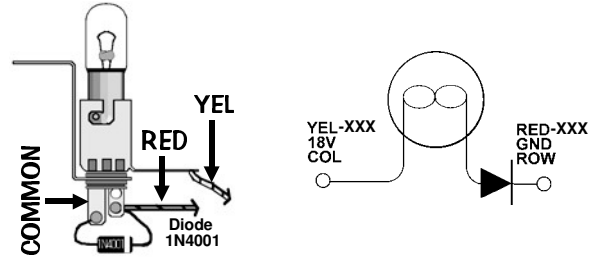

Bulb Types used for Lamps

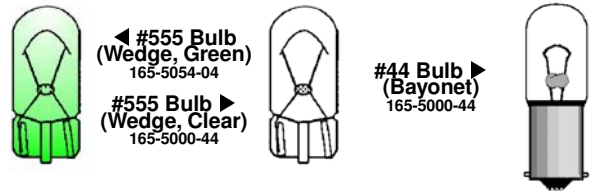

- = Lamps above Playfield.
- = Lamps below Playfield.
- = Lamps not on Playfield.

Lamp Part Notes: #555 Bulb Clear = 165-5002-00. #555 Bulb Green = 165-5054-04. #44 Bulb Clear = 165-5000-44.

See Section 4, Chapter 1, **Parts Identification & Location**, Pages 72-74 for more details on bulbs and corresponding sockets.

Some Lamp Diodes may be located under the playfield, in the Cabinet or Backbox on Terminal Strips and not on or with the Lamp Socket.

DOTS: **D**iode **Q**n **I**terminal **S**trip, see Section 5, Chapter 2, **Playfield Wiring**.

Go To
Diagnostics Menu





Test Flash Lamps

To initiate, from the **DIAGNOSTICS MENU**, select the "FLASH" *Icon* with either the **Red "LEFT"** or **Green "RIGHT" Buttons** and press the **Black "ENTER" Button**. After selecting this *Icon* the display will indicate **CYCLING FLASHERS**. The Flash Lamps will cycle continuously until the test is exited. This test allows the technician to easily spot any burned-out bulbs and replace them. Flashers tested are Flash Lamps in Positions: **Q1-Q32** and in this game Flash Lamp(s) are : **Q14, Q23, Q25-Q27 & Q29-Q32**.

COIN DOOR IS OPEN
PLAYFIELD HIGH POWER
DISABLED BY
COIN DOOR INTERLOCK

PULL OUT the Power Interlock Switch for operation with the Coin Door open.



Clear Ball Trough

To initiate, from the **DIAGNOSTICS MENU**, select the "CLR" *Icon* with either the **Red "LEFT"** or **Green "RIGHT" Buttons** and press the **Black "ENTER" Button**. This Menu is provided to allow the technician a simple method of removing the balls from the trough and also, to test functionality of the trough, ensuring proper trough operation. After selecting this *Icon* the display will show a graphic of the ball trough with balls in the trough with it's corresponding switch number. Select the "RUN" *Mini-Icon* to eject the ball in the first position. Simultaneously, the display and the playfield will eject the ball to the Trough Up-Kicker, eject from the Trough Up-Kicker into the Shooter Lane and will be ejected onto the playfield where the technician can easily retrieve the pinball or allow the ball(s) to re-enter the trough to continue **Clear Ball Trough Test**.

COIN DOOR IS OPEN
PLAYFIELD HIGH POWER
DISABLED BY
COIN DOOR INTERLOCK

PULL OUT the Power Interlock Switch for operation with the Coin Door open.

CAUTION: Continuous use of above test may overheat the Trough Up-Kicker Coil. **▲**



Technician Alerts

To initiate, from the **DIAGNOSTICS MENU**, select the "TECH" *Icon* with either the **Red "LEFT"** or **Green "RIGHT" Buttons** and press the **Black "ENTER" Button**. This Menu is provided to show any switch problems and/or missing pinballs.

Sec. 3: ... Diagnostics

After selecting this *Icon*, and if any of the below criteria is met, the display will indicate *any or all* of the following categories: **POSSIBLY BROKEN SWITCH**, **CHECK SWITCHES** and/or **HYPERSENSITIVE SWITCH** (*Sw. #16, Shooter Lane, is used as an example*). If more than one switch is reported, the Switch Number and Name will cycle within the category, and then will cycle the categories. To return to the **DIAGNOSTICS MENU**, select the "PREV" *Mini-Icon* and press the **Black "ENTER" Button**.

Switch Detection

During game play, activation of switches are monitored. In programming, every switch is given a minimum & maximum value based on the game. The switches are monitored every 5 minutes of game play with a "sliding window" of 15 minutes. If a switch is determined to be faulty, game play is compensated.

- Switches noted as **POSSIBLY BROKEN SWITCH** should be checked, then adjusted or replaced. **Important:** A switch reported as "possibly broken" may actually be an unused switch due to **lack of usage** and **not because they're broken**. This can happen, if a switch is located in a "hard" shot position, and the players are not making the shot. Game programming will still compensate for this unplayed switch.
- Switches noted as **CHECK SWITCHES** are determined to be stuck closed or open depending on switch usage. Free up the switch actuator adjust or replace if necessary.
- Switches noted as **HYPERSENSITIVE SWITCH** means just that, the switch should be readjusted or replace if necessary.

PLAYFIELD STATUS
POSSIBLY BROKEN SWITCH
#02 SHOOTER LANE
PREV QUIT

PLAYFIELD STATUS
CHECK SWITCHES
#02 SHOOTER LANE
PREV QUIT

PLAYFIELD STATUS
HYPERSENSITIVE SWITCH
#02 SHOOTER LANE
PREV QUIT

Determination of switch usage can be checked in **Audits** (review Section 3, Chapter 3, **GO TO AUDITS MENU**). Find the associated Audit with the switch in question and check usage; compare it to commonly used switches for comparison. After any switch is checked and repaired or replaced, it's suggested to test the switch in the **PLAY TEST MENU** (see the **next page**) or **Single Coil Test** (reviewed earlier in this chapter, **Page 18**) where the associated coil to the switch can be tested as well. After correcting the problem, the switch will still be reported until the game is played and the switch is again monitored as specified above. *Only you can determine if a switch getting reported is bad or if the switch is currently not getting actuated during game play.*

Technicians Alerts continued on the next page.





Pinball Detection



While in **Technician Alerts** Menu, if the following is displayed, the game has detected one (1) or more pinball(s) missing and has compensated for the lost pinball(s) to provide normal game play.

Important: Determine where the pinball is! **Do not add pinball(s)** until it is determined the pinball(s) are indeed missing & not just stuck. If pinball(s) are added, & if the original stuck pinball has freed itself, the pinball game will not operate properly with the extra pinball(s). When the pinball is recovered, the above display **will not** appear the next time **Technician Alerts** is visited (a game must be played for the pinball to be determined as found).

During game play, a ball can get trapped or stuck. If after approximately 15 seconds of inactivity or "no scoring," **Ball Search** is started. **Note:** If the pinball is in the *Plunger Lane* or "held" on the flipper, no **Ball Search** will be performed. The game will perform one **Ball Search** in an attempt to "find" or free-up the pinball.



If the game does not see a switch closure (indicating the pinball has not been found), this display will appear with a count-down timer of 20 seconds, during which **Ball Search** will continue until the timer runs out (this feature will not happen if the game is in *Competition Mode*; **Ball Search** will continue until the pinball is found, unstuck and/or replaced manually). The display will momentarily acknowledge the missing pinball(s). The game will provide another pinball into play and will compensate for the lost pinball. Game play will appear normal.

Note: This detection and compensation will happen with every pinball, if each suffers the same fate of a ball trap. If **all** balls get trapped, the game cannot be played or started until the situation is rectified.

Tech Report Alert Option

This game has the capability of **automatically alerting** the operator upon **Power-Up** and/or opening the **Coin Door** if any switch problems and/or missing pinballs has occurred. Review *Section 3, Chapter 4, GO TO ADJUSTMENTS MENU, Standard Adjustments*. The Standard Adjustment to change is **49**. The default for this feature is **NEVER**. The options are: **POWERUP**, **COIN DOOR** or **POWERUP AND COIN DOOR**.



Upon **Power-Up** (Game Reset) and/or opening the **Coin Door** (depending on the option selected), this **display** will flash three (3) times along with an audible sound. To find out the problem, enter this **Technicians Alert Menu** and wait for the displays.

Note: Coils **are not reported** in **Technician Alerts**, **h o w e v e r**, if a faulty switch is the culprit, the switch will then be reported. The below **display** is shown momentarily during **Game Mode** or **Power-Up** to alert the operator



of a coil malfunction (coil doesn't energize or coil fires a multiple number of times). "**OPERATOR ALERT!**" works by monitoring any switch activated coil that has the potential to trap a ball when disabled (e.g. in the *Auto Launch, Scoop, Eject, etc.*). This alert can also appear if a switch associated with a coil (example shown is #2 Auto Launch) is stuck closed (caused by a switch jam or stuck ball); the **CPU/Sound Board** will activate the coil approximately ten times and if the switch remains closed, the game will report this switch in **Technician Alerts** as **CHECK SWITCHES**. The display alert "**PLEASE CHECK TECH REPORT**" will be shown (o n l y i f **POWERUP, COIN DOOR** or **POWERUP AND COIN DOOR** is selected in Standard Adjustment **49**).

Sec. 3: ... Diagnostics



Service Phone

To initiate, from the **DIAGNOSTICS MENU**, select the "SERV" Icon with either the **Red "LEFT"** or **Green "RIGHT"** Buttons and press the **Black "ENTER"** Button. After selecting this Icon the display will indicate a phone number to call if technical assistance is required (In USA Code: 1-800-KICKERS).



Begin Play Test

To initiate, from the **DIAGNOSTICS MENU**, select the "PLAY" Icon with either the **Red "LEFT"** or **Green "RIGHT"** Buttons and press the **Black "ENTER"** Button. After selecting this Icon the technician can test certain play functions to insure all switch activated coils function without entering game play. For example, by rolling the ball over the Shooter Lane switch, the Autoplunger should fire. If it kicks to early or too late, the switch actuator should be adjusted to compensate for this error. If it fails to fire, use the **Switch Test** or **Coil Test** to help determine the cause of the failure. During this Play Test, check all coil assemblies with related switches in the game. For unique Game Test(s), select the "**Ring**" Icon in the **DIAGNOSTICS MENU**, reviewed on Pages **27-28**.



PULL OUT the Power Interlock Switch for operation with the Coin Door open.





Fire Knocker

To initiate, from the **DIAGNOSTICS MENU**, select the "KNOCKER" *Icon* with either the **Red "LEFT"** or **Green "RIGHT" Buttons** and press the **Black "ENTER" Button**. The digitally mastered "Knocker" is sounded.



Sound / Speaker Test

To initiate, from the **DIAGNOSTICS MENU**, select the "SPKR" *Icon* with either the **Red "LEFT"** or **Green "RIGHT" Buttons** and press the **Black "ENTER" Button**. The BSMT 2000 Sound System produces true digital stereo sound from Backbox & Cabinet Speakers or "Mono" on the Cabinet Speaker (when used by itself). After selecting this *Icon*, select the "-" or "+" *Mini-Icons* and press the **Black "ENTER" Button** to *activate* the first test. Repeat to visually see & hear all tests. Select the "RUN" *Mini-Icon* to *activate* the test chosen without moving to the next test.

Note: During Sound Tests, the display shows the speaker identification and the corresponding sound(s). The sound functions allow verification that both channels are functioning properly & that the speaker connections are correct.

Speaker Phase Testing

Connections to each of speakers are polarized and each must be connected appropriately for the best quality sound. If one speaker has the positive and negative connections reversed with respect to the other one, bass frequencies will not be produced properly and the overall sound quality will be poor. To test for proper speaker phasing, use the sound test to cycle through the Backbox & Cabinet, and Backbox Sine (repeated) functions. If the Cabinet Sine produces more volume and bass than the Left Sine, the speakers are connected properly. If it produces the same or less, one speaker is connected improperly. To isolate and correct reversed speaker connections, one of two methods may be used.

1. Check each speaker for polarity markings. If the speakers have polarity markings, verify that the Backbox Speaker **RED-WHT** Wire and the Cabinet Speaker **YEL-WHT** Wire is connected to the negative (-) terminal.
2. Disconnect the speaker output connector from the CPU / Sound Board and connect a 1.5-volt battery across each speaker pair one at a time while observing the speakers. Make sure the positive battery terminal is connected to the positive lead (CN4, Pin-3 (**RED-BLK**) or Pin-6 (**YEL-BLK**)) each time. As the connection is made, check speaker cone movement; proper connections are indicated by outward movement.

Sec. 3: ... Diagnostics

Note: For ROM Usage (Summary Table) & Locations, see Page DR.

① in the "Find-It-In-Front: Dr. Pinball Section". Voice ROMs (U17, U21, U36 and/or U37) which are 8MB must have a Jumper at W6 on the CPU/Sound Board to function properly.

Auto / Manual Tests	Sounds Produced
Speaker Test	Tone
Sound/OPSYS EPROM (Loc. U7)	Level 1-3+ (Music Test)
Voice ROMs: 1 (U17) 2 (U21) 3 (U36) 4 (U37)	Speech Pattern 1-3+



Begin Burn In

To initiate, from the **DIAGNOSTICS MENU**, select the "BURN" *Icon* with either the **Red "LEFT"** or **Green "RIGHT" Buttons** and press the **Black "ENTER" Button**. After selecting this *Icon* the **Begin Burn-In Test** will start. At this stage the game will exercise all CPU I/O Functions (**Dot Matrix Display Test, Coil Testing, Lamp Testing, Sound...**, etc.). This is provided to constantly exercise sounds, coils, etc... Cumulative Burn-In minutes will be displayed. **Note:** To reset Burn-In minutes to 00 see Section 3, Chapter 6, GO TO RESET MENU, Factory Reset. **Caution:** Performing a Factory Reset will reset all other information as well.



Dot Matrix Test

To initiate, from the **DIAGNOSTICS MENU**, select the "DOT TEST" *Icon* with either the **Red "LEFT"** or **Green "RIGHT" Buttons** and press the **Black "ENTER" Button**. After selecting this *Icon* the **Dot Matrix Test** immediately begins. **Note:** Pressing any button will exit the test & return to **DIAGNOSTICS MENU**. The display will immediately illuminate & cycle for 1 pass of each test continuously for each of the following:

Test 1



Illuminates 1 vertical column of dots, turning it off & illuminating the next column, until each column has been individually lit, while the other columns are off.

Test 2

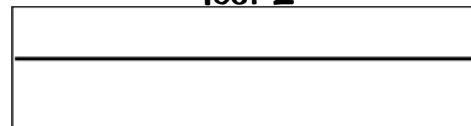

Illuminates 1 horizontal row of dots, turning it off & illuminating the next row, until each row has been individually lit, while the other rows are off.





Dot Matrix Test Continued

Test 3



Illuminates all the dots,
except for one column from left to right.

Test 4



Illuminates all the dots,
except for one row from top to bottom.

Test 5



Illuminates every other dot lit,
in both the rows and columns.

Note: Pressing the **Red, Green, Black** or **Flipper Buttons** will exit the test & return to **DIAGNOSTICS MENU**.

Dot Matrix Display Explained

The display utilizes a **Micro-Processor Control Board** mounted in piggyback fashion to the **Dot Matrix Display (128 X 32) Driver Board**. The purpose behind this board is to provide more information to the operator as well as displaying graphics to the player.

The board is controlled by a **6809E Microprocessor** and its personality ROM (Unique to the Game). It receives Data, Reset & Clock Information from the **CPU/Sound Board** via the ribbon cable and sends back multiple Status and Busy Signals to the **CPU**. This is to insure synchronized communication between the **CPU** and the **Display Controller Board**. The Drivers for the rows and columns are provided on 5 surface mounted integrated circuits on the **Dot Matrix Display Driver Board**.



LOTR Tests

To initiate, from the **DIAGNOSTICS MENU**, select the "LOTR" *Icon* with either the **Red "LEFT"** or **Green "RIGHT"** Button and press the **Black "ENTER"** Button.

COIN DOOR IS OPEN
PLAYFIELD HIGH POWER
DISABLED BY
COIN DOOR INTERLOCK

PULL OUT the Power Interlock Switch for operation with the Coin Door open.

This will bring up the **LOTR TESTS MENU**, with the "RING" *Icon* (**RING MAGNET TEST**) flashing. This Sub-Menu is used to test the operation of the **Ring OPTO Switches, Back Panel Trough Switch & Spinner (Center Ramp) Switch and the Magnet Coil Operation ("RING" Icon); 19-LEDs (these are not Controlled Lamps) ("LED" Icon); Balrog Open, Close & Bash Switches and the Balrog Motor Operation ("BROG" Icon)**. To initiate, from the **LOTR TESTS MENU**, select one of the 3 *Icons* with either the **Red** or **Green Buttons** and press the **Black Button**. After finishing the Test, select the "PREV" *Icon* to return to the Sub-Menu or select either of the ">>" *Icon* to slip between the 3 Testing Menus.

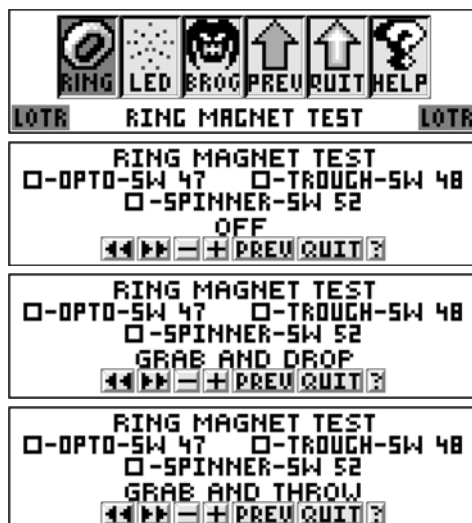

Ring Magnet Test

Selecting the "RING" *Icon* will bring up the **RING MAGNET TEST MENU** with the "+" *Mini-Icon* flashing and the **Magnet Test** set to **OFF**. These tests are provided to allow a method of testing the **Ring Made (OPTOs) (Sw. 47), Back Trough (Sw. 48), Spinner (Sw. 52), and Ring Magnet (Q6) operation**. *Switches 47, 48 & 52 are in a Normally Open state.*

Select and **activate** the "+" *Mini-Icon* to cycle between the two (2) Magnet Tests: **GRAB AND DROP** (ball will release forward) or **GRAB AND THROW** (ball will enter the Back Panel to test the Back Trough Switch). *With ball-in-hand, roll onto the Center Ramp. As the Spinner (Sw. 52) is closed, the □ box will turn solid ■; the ball should launch into the Magnet Ring. The Magnet (Q6) is then pulsed, grabbing the ball and either will drop it forwards or throw it backwards (depends chosen test). As the Ring Made (Sw. 47) is momentarily closed, the □ box will turn solid ■ then □ again. If test is "Grab & Throw", the ball will enter the Back Panel Trough and the Back Trough (Sw. 48) will momentarily close, the □ box will turn solid ■ then □ again (with the ball returning on the Center Wire Ramp). You can also hand check the 3 switches as well. The OPTOs*

are in the ring (break the light path by placing finger into the hole). The trough switch can be accessed through the other hole above the Wire Ramp. See Sec. 4, Chp. 2, Drawings..., Pgs. 94-96 and Sec. 5, Chp. 4, PCBs, Page 143 for a close up view on the OPTO Switches and the OPTO Transmitter / Receiver Amplifier Board.

Go To
Diagnostics Menu



LOTR Tests continued on the next page.



LED Test

Selecting the "LED" *Icon* will bring up the **LED TEST MENU** with the "+" *Mini-Icon* flashing and the **LED Test** set to **ALL OFF**. This test is provided to allow a method of testing the **19-LED PCB** located between the flippers. **Note:** *These LEDs are not Controlled Lamps (i.e. not part of the Lamp Matrix.)*

Select and *activate* the "+" *Mini-Icon* to cycle between the twenty (20) LED Tests (**ALL ON**, **LED #1** through **LED #19**). **ALL ON** = All 19 LEDs will blink **ON** and **OFF** until the test is exited. **LED #1** = L1 will blink **ON** and **OFF**. **LED #2** through **LED #19** will follow suit.

See Section 5, Chapter 4, PCBs, Page 144 for a close up view of the 19-LED PCB.

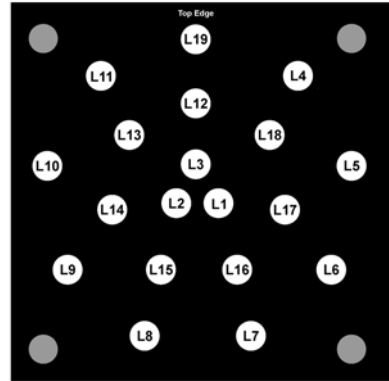

CAUTION: Be careful of moving parts!
The following test has a moving part and will activate upon selection of this test. Keep fingers clear.



Sec. 3: ... Diagnostics



Balrog Test

Selecting the "BROG" *Icon* will bring up the **BALROG TEST MENU** with the "RUN" *Mini-Icon* flashing. **Note:** Upon selection of the "BROG" *Icon*, (and with the Power Interlock Switched pulled out), the motor will cycle, moving the Balrog, blocking the entrance of the Center Ramp (Fig. 1).



PULL OUT the Power Interlock Switch for operation with the Coin Door open.

to allow a method of testing the **Balrog Open (Sw. 31)**, **Balrog Closed (Sw. 32)** and **Balrog (Bash) Hit (Sw. 28)** and **Balrog Motor (Q32)** operation in conjunction with the **Motor Relay Board (Q20)**. Switches 31, 32 & 28 are in a **Normally Closed** state (Switches 31 & 32 are under the playfield on the Motor Assembly; Switch 28 is located inside the Balrog Assembly). With the Balrog now blocking the Center Ramp (Fig. 1), with ball-in-hand, roll the ball at the front hit plate (knocking the Balrog Over), and note the **Bash (Sw. 28, Balrog Hit)** box will turn , thus indicating proper operation.

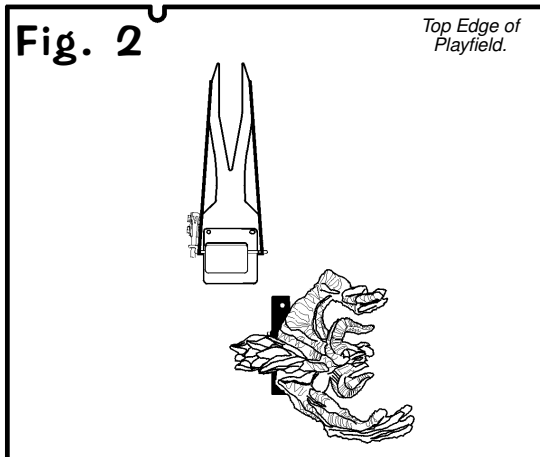
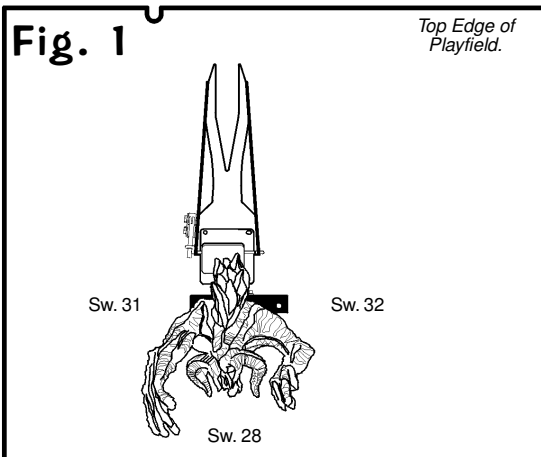

Select and *activate* the "RUN" *Mini-Icon* to cycle the Motor. As the Balrog opens the Center Ramp (Fig. 2) and comes to a rest, the **Balrog Closed (Sw. 32)** will open, the solid box will turn and **Balrog Open (Sw. 31)** will close, the box will turn solid .

For more details of the Switches & Coils (Part Numbers & views) tested on this and the previous page, review Section 4, Chapter 2, Drawings for Major Assemblies & Ramps, Pages 93-97.





Go To Fuse Table

To initiate, from the **DIAGNOSTICS MENU**, select the "FUSES" *Icon* with either the Red "LEFT" or Green "RIGHT" Buttons and press the Black "ENTER" Button. The **FUSE TABLE MENU** now appears. This provides the technician with the current **Fuse Table** for this game (also noted on a decal in the Backbox). The fuses are located in the Backbox (on the **Display Power Supply Board** and the **I/O Power Driver Board**), and also in the Cabinet (under the playfield by the **Flippers** and/or by any unique assembly requiring an additional fuse, such as magnets). For the complete **Fuse List** in the **Quick Reference Fuse Chart & Pictorials**, see the next page or Page DR. 1 (front of this manual).

Example:

After entering **Portals™**, the **MAIN MENU** now appears with the "DIAG" *Icon* (GO TO DIAGNOSTICS MENU) flashing:

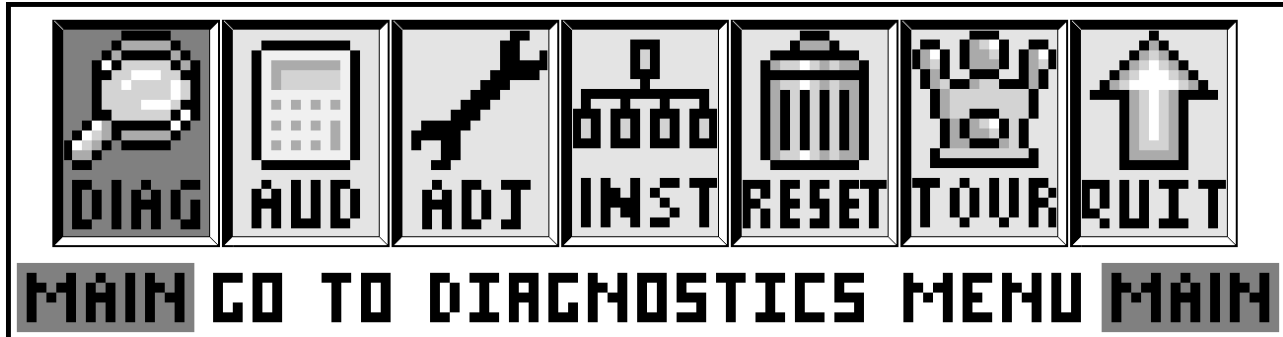

Press the Black "ENTER" Button to *activate* this **ICON**. The **DIAGNOSTICS MENU** now appears with the "SW" *Icon* (GO TO SWITCH MENU) flashing; use the Red "LEFT" or Green "RIGHT" Buttons, until the "FUSES" *Icon* (GO TO FUSE TABLE) is flashing:

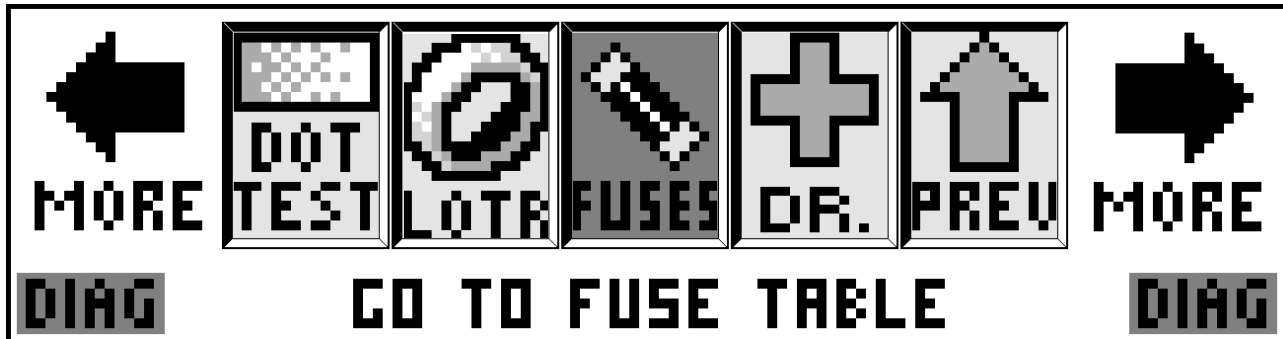

Press the Black Button to *activate* this **ICON**. The **FUSE TABLE** now appears.

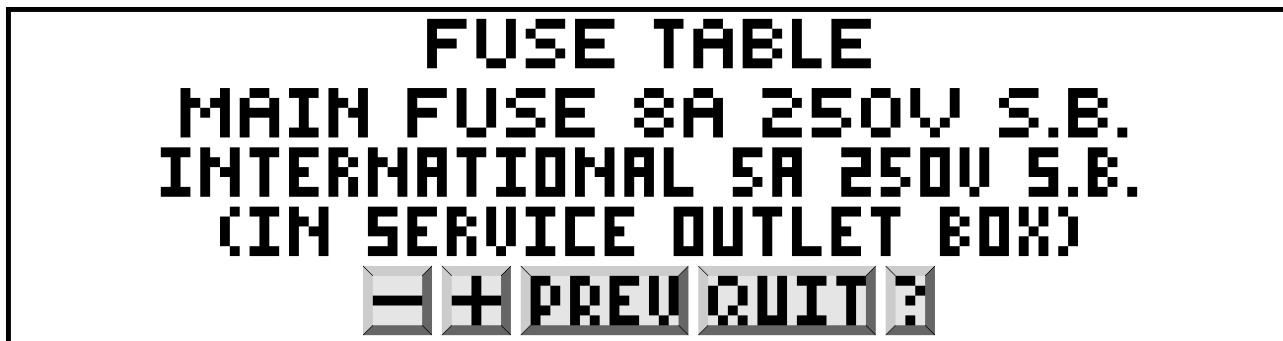

Select and *activate* the "+" *Mini-Icon* to view the next fuse in the group. Continue to select either the "+" or "-" *Mini-Icons* to view each fuse one at a time. The display will describe the fuse identification number (e.g. Main, F1, F6, F7, etc.), rating of fuse (e.g. 5A 250v S.B. - i.e. 5 Amp, 250 volt, Slo-Blo), location of fuse (i.e. Backbox: Board Name located on; or Cabinet: Under the playfield or in Service Outlet), and 'use of fuse' (e.g. 90v DC High Voltage Power, etc.). The current fuse listed will remain in the display until the next fuse is chosen or when the Sub-Menu is exited by selecting & *activating* the "PREV" or "QUIT" *Mini-Icons*.

Go To Fuse Table continued on the next page.



Backbox PCB Fuses, ROMs, Bridges, Relays, P/F & Cabinet Fuses, Cab. Switches

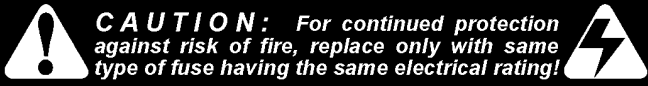

QUICK REFERENCE FUSE CHART

Backbox Fuses

LOC: DISPLAY POWER SUPPLY (P.S.) BOARD			
F1	3/4A 250v S.B.	90v DC	High Voltage Display
LOC: I / O POWER DRIVER BOARD			
F6	7A 250v S.B.	50v DC	Primary High Power Coils/Flippers
F7	5A 250v S.B.	20v DC	Low Power Coils
F8	5A 250v S.B.	12v DC	Logic Power
F9	5A 250v S.B.	12v DC	Logic Power
F20	4A 250v S.B.	50v DC	Magnet <<<< THIS GAME ONLY
F21	3A 250v S.B.	50v DC	Coils
F22	8A 250v S.B.	18v DC	Controlled Lamps
F23	4A 250v S.B.	5v DC	Logic
F24	5A 250v S.B.	6.3v AC	G.I. Lamps (BRN-WHT to WHT-BRN)
F25	5A 250v S.B.	6.3v AC	G.I. Lamps (YEL to WHT-YEL)
F26	5A 250v S.B.	6.3v AC	G.I. Lamps (GRN to WHT-GRN)
F27	5A 250v S.B.	6.3v AC	G.I. Lamps (VIO to WHT-VIO)
F28	3A 250v S.B.	24v AC	Not Used / Spare

Cabinet Fuses

LOC: SERVICE (AC) OUTLET BOX (Cabinet Bottom)		
n/a	8A 250v S.B.	115v AC Main Fuse Line (Domestic or USA)
n/a	5A 250v S.B.	220v AC Main Fuse Line (International)

Playfield (P/F) Fuses

LOC: UNDER PLAYFIELD (near Flippers)			
n/a	3A 250v S.B.	50v DC	Right Flipper (BLU-YEL ↔ RED-YEL)
n/a	3A 250v S.B.	50v DC	Left Flipper (GRY-YEL ↔ RED-YEL)
n/a	3A 250v S.B.	50v DC	Loop Diverter (GRY-YEL ↔ YEL-VIO)

For locations & more information on fuses, see Sec. 5, Chapter 2.

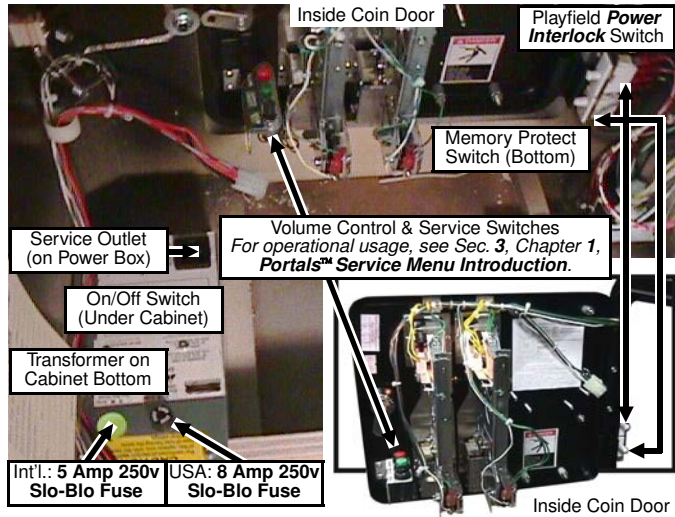

ROM TYPE on BD	LOCATION	SIZE	PART NUMBER
CPU Sound	U7	512K	965-0401-80
CPU Game	U210	1 MB	965-0402-80
CPU Voice ROM 1	U17	8 MB	965-0403-80
CPU Voice ROM 2	U21	8 MB	965-0404-80
CPU Voice ROM 3	U36	8 MB	965-0405-80
CPU Voice ROM 4	U37	8 MB	965-0406-80
DISPLAY Controller	U5	4 MB	965-0407-80

Sec. 3: ... Diagnostics

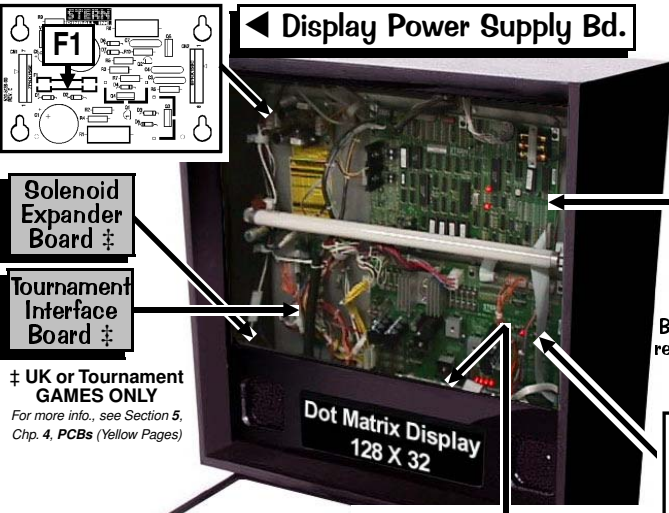

Display Controller Bd.

The Display Controller has the Display EPROM (Location: U5 / ROM 0). This board is located behind the 128 X 32 Dot Matrix Display Board.

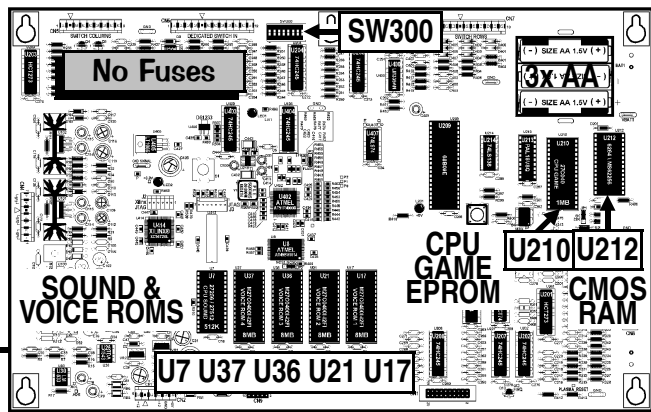
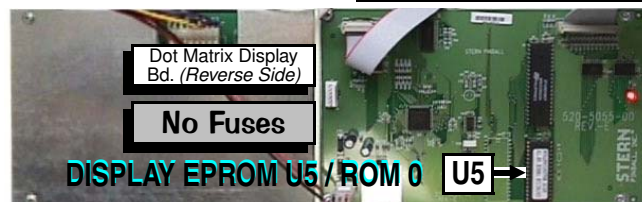
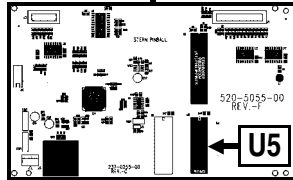

For Schematics and/or Component Parts on PC Boards shown on this page, review Section 5, Chapter 4, Printed Circuit Boards (The Yellow Pages).

CPU/Sound Bd. II w/ATMEL ▲

I/O Power Driver Board ▼

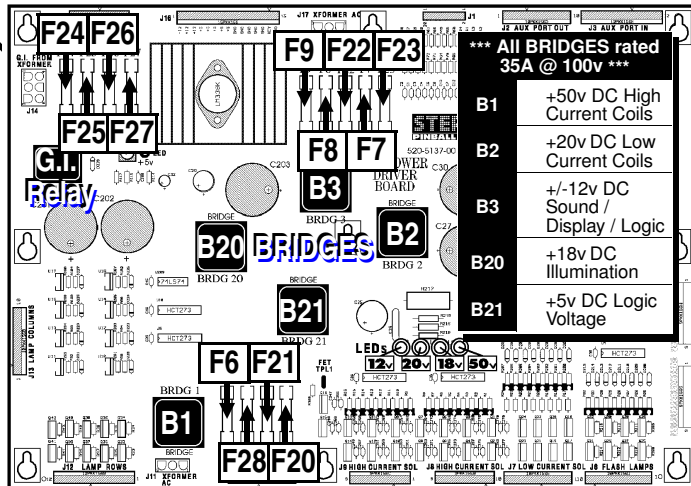

*** All BRIDGES rated 35A @ 100v ***

B1	+50v DC High Current Coils
B2	+20v DC Low Current Coils
B3	+/- 12v DC Sound / Display / Logic
B20	+18v DC Illumination
B21	+5v DC Logic Voltage





Dr. Pinball

To initiate, from the **DIAGNOSTICS MENU**, select the Cross "DR." *Icon* with either the **Red "LEFT"** or **Green "RIGHT" Buttons** and press the **Black "ENTER" Button**. This will bring you (the operator / technician) into **DR. PINBALL (Flow Chart Menus)** which offers you a choice of three (3) *Icons*: Coil "DR.", Switch "DR." and Lamp "DR." *Icons*. Selecting a particular *Icon* will give you a choice of which specific Coil (*any and all coil assemblies such as Flippers, VUKs, Magnets, etc.*), Switch or Lamp circuit needs to be diagnosed. *Dr. Pinball* will now display a question or give a procedure to follow such as "Does the lamp turn on?" or "Check bridge rectifier BR-20, if short replace." When *Dr. Pinball* displays a question or requests a procedure, *Dr. Pinball* will expect a response such as "NO" or "YES" (*see below examples of the Mini-Icons* which will prompt the operator). You the operator/technician must respond by using the **Red or Green Buttons** to "SELECT" a *Mini-Icon* and the **Black Button** to "ACTIVATE or ENTER" your selection.



Coil Flow Chart

To initiate, from the **DR. PINBALL MENU**, select the Coil "DR." *Icon* with either the **Red or Green Buttons** and press the **Black Button**. This is the **Coil Flow Chart**. Follow the questions, answering by using the *Mini-Icons* in the display.



Switch Flow Chart

To initiate, from the **DR. PINBALL MENU**, select the Switch "DR." *Icon* with either the **Red or Green Buttons** and press the **Black Button**. This is the **Switch Flow Chart**. Follow the questions, answering by using the *Mini-Icons* in the display.



Lamp Flow Chart

To initiate, from the **DR. PINBALL MENU**, select the Lamp "DR." *Icon* with either the **Red or Green Buttons** and press the **Black Button**. This is the **Lamp Flow Chart**. Follow the questions, answering by using the *Mini-Icons* in the display.

The following are the *Mini-Icons* with explanations for the **DR. PINBALL** Sub-Menus:



Select and *activate* either the "-" or "+" *Mini-Icons* to diagnose a Coil, Lamp or Switch. Select and *activate* the "RUN" *Mini-Icon* to test selected item. The "PREV" *Mini-Icon* allows you to go back to previous question. Select the "QUIT" *Mini-Icon* to exit **Portals™** completely. Select the "?" *Mini-Icon* (Help) to see directions on button usage.



Select and *activate* either the "NO" or "YES" *Mini-Icons* to answer a question given. Select and *activate* the "END" *Mini-Icon* to change to a new item to test. The "PREV" *Mini-Icon* allows you to go back to previous question. Select the "QUIT" *Mini-Icon* to exit **Portals™** completely. Select the "?" *Mini-Icon* (Help) to see directions on button usage.



After a diagnosis is given, select and *activate* the "END" *Mini-Icon* to change to a new item to test. The "PREV" *Mini-Icon* allows you to go back to previous display. Select the "QUIT" *Mini-Icon* to exit **Portals™** completely. Select the "?" *Mini-Icon* (Help) to see directions on button usage.



In **COIL FLOW CHART MENU**, select and *activate* the "PULSE" *Mini-Icon* to pulse the coil selected. Select and *activate* the "END" *Mini-Icon* to change to a new item to test. The "PREV" *Mini-Icon* allows you to go back to previous question. Select the "QUIT" *Mini-Icon* to exit **Portals™** completely. Select the "?" *Mini-Icon* (Help) to see directions on button usage.

Go To
Diagnostics Menu



STARTING METER Reading :

--	--	--	--	--	--	--	--

STARTING METER Date (MM/DD/YR) :

						0	
--	--	--	--	--	--	---	--

AUDITOR'S NAME :

CURRENT VOLUME SETTING:

▶▶▶		
-----	--	--

CURRENT METER Reading :

--	--	--	--	--	--	--	--

AUDIT Date (MM/DD/YR) :

						0	
--	--	--	--	--	--	---	--

CPU Version :

DISPLAY Version :

GAME LOCATION NAME :

EARNINGS & STANDARD AUDIT TABLES

MAIN	GO TO AUDITS MENU	MAIN	AUD	EARNINGS AUDITS	AUD								

EARNINGS AUDITS 01-14

Audit definitions follow in this Chapter.

01	TOTAL PAID CREDITS
02	FREE GAME PERCENTAGE
03	AVERAGE BALL TIME
04	AVERAGE GAME TIME
05	COINS THRU LEFT SLOT

06	COINS THRU RIGHT SLOT
07	COINS THRU CENTER SLOT
08	COINS THRU 4TH SLOT
09	COINS THRU 5TH SLOT
10	COINS THRU 6TH SLOT

11	TOTAL COINS
12	TOTAL EARNINGS
13	METER CLICKS
14	SOFTWARE METER

MAIN	GO TO AUDITS MENU	MAIN	AUD	STANDARD AUDITS	AUD								

STANDARD AUDITS 01-68

Audit definitions follow in this Chapter.
To track Feature & Tournament Audits, see Pages 36 or 54.

01	TOTAL BALLS PLAYED
02	TOTAL EXTRA BALLS
03	EXTRA BALL PERCENT
04	REPLAY 1 AWARDS
05	REPLAY 2+ AWARDS
06	TOTAL REPLAYS
07	REPLAY PERCENT
08	TOTAL SPECIALS
09	SPECIAL PERCENT
10	TOTAL MATCHES
11	HIGH SCORE AWARDS
12	HIGH SCORE PERCENT
13	TOTAL FREE PLAYS
14	TOTAL PLAYS
15	0-1.9M SCORES
16	2M-3.9M SCORES
17	4M-5.9M SCORES
18	6M-7.9M SCORES
19	8M-9.9M SCORES
20	10M-12.4M SCORES
21	12.5M-14.9M SCORES
22	15M-17.4M SCORES
23	17.5M-19.9M SCORES
24	20M-22.4M SCORES

25	22.5M-24.9M SCORES
26	25M-34.9M SCORES
27	35M-49.9M SCORES
28	50M-74.9M SCORES
29	75M-99.9M SCORES
30	100M-149.9M SCORES
31	150M+ SCORES
32	AVERAGE SCORES
33	SERVICE CREDITS
34	BALL SEARCH STARTED
35	LOST BALL FEEDS
36	LOST BALL GAME STARTS
37	LEFT DRAINS
38	CENTER DRAINS
39	RIGHT DRAINS
40	TILTS
41	TOTAL BALLS SAVED
42	PROPRIETARY
43	PROPRIETARY
44	PROPRIETARY
45	PROPRIETARY
46	PROPRIETARY
47	PROPRIETARY
48	PROPRIETARY

49	PROPRIETARY
50	BASE REPLAY
51	LEFT FLIPPER USED
52	RIGHT FLIPPER USED
53	PROPRIETARY
54	PROPRIETARY
55	0-1 MINUTE GAMES
56	1 - 1.5 MINUTE GAMES
57	1.5 - 2 MINUTE GAMES
58	2 - 2.5 MINUTE GAMES
59	2.5 - 3 MINUTE GAMES
60	3 - 3.5 MINUTE GAMES
61	3.5 - 4 MINUTE GAMES
62	4 - 5 MINUTE GAMES
63	5 - 6 MINUTE GAMES
64	6 - 8 MINUTE GAMES
65	8 - 10 MINUTE GAMES
66	10 - 15 MINUTE GAMES
67	15+ MINUTE GAMES
68	RECENT REPLAY PERCENT

Note: Audits are subject to change (with or without notice).



Go To
Audits Menu



Go To Audits Menu

Overview

The Portals™ Service Menu System provides **236** Audits for accounting purposes and for evaluation of *Game Programming*. The Audits are divided into 3 groups: • **Earnings Audits** (Audits **01-14**), • **Standard Audits** (Audits **01-68**) and • **Feature Audits (Programming Use Only)** (Audits **01-154**). For details on **Tournament Audits**, see Section 3, Chapter 7, **GO TO TOURNAMENT MENU**. Audits which are named **Proprietary** are also for **Future Expansion or Programming**. Game code may get upgraded during production; compare all Audits in the display with the manual and make any corrections to the Audit Table (*previous page*), as necessary. Audits are subject to change (with or without notice). To view Audits in the display, enter the **Portals™ Service Menu System**. For how to **RESET** Audits, see Section 3, Chapter 6, **GO TO RESET MENU**.



EXPLANATION & USAGE OF COMMON LARGE & MINI-ICONS USED IN VARIOUS MENUS & SUB-MENUS:



These *non-selectable* icons appear in the selected Menu only when there are MORE icons to the LEFT or to the RIGHT available for selection.



Select and activate to return to the PREVIOUS Menu.



Select and activate to QUIT, exits & returns to the Attract Mode.



Select and activate to view HELP Screens of the current Menu*.



Move LEFT or RIGHT, select previous / next or move backwards / forwards.

Select and activate to:

* Help Note: An explanation of each Mini-Icon at that menu level will cycle continuously. To exit a display where no Mini-Icons are available for selection, pressing any button will exit the display.

GO TO AUDITS MENU

After entering **Portals™**, the **MAIN MENU** now appears. Select the "AUD" *Icon* in the **MAIN MENU** with either the **Red "LEFT"** or **Green "RIGHT"** Buttons (the **Flipper Buttons** operates in the same manner) and press the **Black "ENTER"** Button (the **Start Button** operates in the same manner). The **AUDITS MENU** appears. Continue through this chapter for the explanation & usage of the *Icons* in the **AUDITS MENU**.

Earnings Audits (01-14)

To initiate, from the **AUDITS MENU**, select the "EARN" *Icon* with either the **Red "LEFT"** or **Green "RIGHT"** Buttons and press the **Black "ENTER"** Button. Select and *activate* either of the ">>" *Mini-Icons* to view the next or previous Audit in this group. The display will describe the **Audit Number**, **Audit Name** and the **Current Audit Total** (Value). The current Audit will remain in the display until the next Audit is viewed or when this Menu is exited.

Nr.	EARNINGS AUDIT NAME: Definition
01	TOTAL PAID CREDITS: Provides the total number of <i>Paid Credits</i> .
02	FREE GAME PERCENTAGE: Provides the percentage total by dividing Standard Audit 13, TOTAL FREE PLAYS , by Standard Audit 14, TOTAL PLAYS .
03	AVERAGE BALL TIME: In seconds, the average ball time is derived from the total play time divided by Standard Audit 01, TOTAL BALLS PLAYED .
04	AVERAGE GAME TIME: The average game time is expressed in minutes and seconds (0:00).
05	COINS THRU LEFT SLOT: Provides the total number of times Coin Mechanism Switch 06 was closed.
06	COINS THRU RIGHT SLOT: Provides the total number of times Coin Mechanism Switch 04 was closed.
07	COINS THRU CENTER SLOT: Provides the total number of times Coin Mechanism Switch 05 was closed.
08	COINS THRU 4TH SLOT: Provides the total number of times Coin Mechanism Switch 02 was closed.
09	COINS THRU 5TH SLOT: Provides the total number of times Coin Mechanism Switch 07 was closed.
10	COINS THRU 6TH SLOT: Provides the total number of times Coin Mechanism Switch 03 was closed.
11	TOTAL COINS: Provides the total amount of coins registered through all the <i>Coin Slots</i> .
12	TOTAL EARNINGS: The total cash value accumulated since the last Factory Reset occurred. See Section 3, Chapter 6, GO TO RESET MENU , Reset Coin Audits .
13	METER CLICKS: Provides the total number of money clicks accumulated. <i>Based on the country's lowest coin denomination used for the game credit.</i>
14	SOFTWARE METER: Provides the continuing total of Meter Clicks. <i>This audit cannot be reset; the display shows the constant addition of Meter Clicks.</i>





Standard Audits (01-68)

To initiate, from the **AUDITS MENU**, select the "S.P.I." *Icon* with either the **Red "LEFT"** or **Green "RIGHT" Buttons** and press the **Black "ENTER" Button**. Select and *activate* either of the ">>" *Mini-Icons* to view the next or previous Audit in this group. The display will describe the **Audit Number**, **Audit Name** and the **Current Audit Total** (Value). The current Audit will remain in the display until the next Audit is viewed or when this Menu is exited.

Nr.	STANDARD AUDIT NAME: Definition
01	TOTAL BALLS PLAYED: Provides the total number of <i>Regular</i> and <i>Extra Balls</i> .
02	TOTAL EXTRA BALLS: Provides the total number of <i>Extra Balls</i> awarded.
03	EXTRA BALLS PERCENT: Provides the percentage total by dividing Standard Audit 02, TOTAL EXTRA BALLS , by Standard Audit 14, TOTAL PLAYS .
04	REPLAY 1 AWARDS: Provides the total <i>Awards (Credits, Extra Balls or Scores)</i> for Level 1.
05	REPLAY 2+ AWARDS: Provides the total <i>Awards (Credits, Extra Balls or Scores)</i> for Level 2 or higher.
06	TOTAL REPLAYS: Provides the total <i>Awards (Credits, Extra Balls or Scores)</i> for exceeding <i>Replay Score Levels</i> .
07	REPLAY PERCENT: Provides the percentage total from dividing Standard Audit 06, TOTAL REPLAYS , by Standard Audit 14, TOTAL PLAYS . The percentage reflects replay total awards for exceeding replay score levels.
08	TOTAL SPECIALS: Provides the total <i>Awards (Credits, Extra Balls, or Scores)</i> for making <i>Specials</i> .
09	SPECIAL PERCENT: Provides the percentage total by dividing Standard Audit 08, TOTAL SPECIALS , by Standard Audit 14, TOTAL PLAYS .
10	TOTAL MATCHES: Provides the total <i>Credits</i> awarded for matching the last two digits of the score with the <i>System-Generated Match Number</i> at the end of the game. Percentage of <i>Match Credits</i> is adjustable from 0% to 10% by Standard Adjustment 13, MATCH PERCENTAGE , if enabled. See Section 3, Chapter 4, GO TO ADJUSTMENTS MENU, Standard Adjustments .
11	HIGH SCORE AWARDS: Provides the total <i>Awards (Credits, Extra Balls, or Scores)</i> for exceeding the High-Score-To-Date scores.
12	HIGH SCORE PERCENT: Provides the percentage total by dividing Standard Audit 11, HIGH SCORE AWARDS , by Standard Audit 14, TOTAL PLAYS .
13	TOTAL FREE PLAYS: Provides the total <i>Free Credits</i> for <i>Replays, High-Score-To-Date, Specials and Match</i> .
14	TOTAL PLAYS: This total is derived by adding the sum of Earnings Audit 01, TOTAL PAID CREDITS , and Standard Audit 13, TOTAL FREE PLAYS . <i>Note: Free Credits are not recorded in the Audit until they are actually used.</i>
15	0-1.9M SCORES: Provides the total number of games the Player's final score was 0 and 1,999,990 points.
16	2M-3.9M SCORES: ... and the Player's final score was between 2,000,000 and 3,999,990 points.
17	4M-5.9M SCORES: ... and the Player's final score was between 4,000,000 and 5,999,990 points.
18	6M-7.9M SCORES: ... and the Player's final score was between 6,000,000 and 7,999,990 points.
19	8M-9.9M SCORES: ... and the Player's final score was between 8,000,000 and 9,999,990 points.
20	10M-12.4M SCORES: ... and the Player's final score was between 10,000,000 and 12,499,990 points.
21	12.5M-14.9M SCORES: ... and the Player's final score was between 12,500,000 and 14,499,990 points.
22	15M-17.4M SCORES: ... and the Player's final score was between 15,000,000 and 17,499,990 points.
23	17.5M-19.9M SCORES: ... and the Player's final score was between 17,500,000 and 19,999,990 points.
24	20M-22.4M SCORES: ... and the Player's final score was between 20,000,000 and 22,499,990 points.
25	22.5M-24.9M SCORES: ... and the Player's final score was between 22,500,000 and 24,999,990 points.
26	25M-34.9M SCORES: ... and the Player's final score was between 25,000,000 and 34,999,990 points.
27	35M-49.9M SCORES: ... and the Player's final score was between 35,000,000 and 49,999,990 points.
28	50M-74.9M SCORES: ... and the Player's final score was between 50,000,000 and 74,999,990 points.
29	75M-99.9M SCORES: ... and the Player's final score was between 75,000,000 and 99,999,990 points.
30	100M-149.9M SCORES: ... and the Player's final score was between 100,000,000 and 149,999,990 points.
31	150M+ SCORES: Provides the total number of games the Player's final score was 150,000,000 points and over.
32	AVERAGE SCORES: This total is derived from adding the <i>Final Score</i> of each game to a table and dividing this sum by Standard Audit 14, TOTAL PLAYS .

Sec. 3: Go To Audits

Standard Audits 33-68 continued on the next page.





- 33 **SERVICE CREDITS:** Provides the total number of times the **Portals™ Green Button** (Dedicated Switch 7) was pushed in **Attract Mode**.
See Section 3, Chapter 1, Service Switch Set Access & Use, for how to receive Service Credits.
See Sec. 3, Chp. 6, GO TO RESET MENU, Reset Credits, for how to delete Service (and Paid Credits).
- 34 **BALL SEARCH STARTED:** Provides the total number of times the game performed a *Ball Search*.
- 35 **LOST BALL FEEDS:** Provides the total number of times the game added a pinball to play when it could not find a pinball after *Ball Search*.
See Section 3, Chapter 2, GO TO DIAGNOSTICS MENU, Technicians Alert [Pinball Detection].
- 36 **LOST BALL GAME STARTS:** Provides the total number of times the game started with a pinball missing from the ball trough at the start of a game.
See Section 3, Chapter 2, GO TO DIAGNOSTICS MENU, Technicians Alert [Pinball Detection].
- 37 **LEFT DRAINS:** Provides the total number of times Rollover Switch 57 was closed.
- 38 **CENTER DRAINS:** Provides the total number of times the pinball had drained when the last switch closed was not Switch 57 or Switch 60.
- 39 **RIGHT DRAINS:** Provides the total number of times Rollover Switch 60 was closed.
- 40 **TILTS:** Provides the total number of times Contact Switch 56 was closed.
- 41 **TOTAL BALLS SAVED:** Provides the total number of times this feature was used (*this feature can be turned ON or OFF, see Standard Adj. 38, FREEZE TIME in Section 3, Chapter 4, GO TO ADJUSTMENTS MENU, Standard Adjustments*). This feature is enabled at the start of each pinball and is disabled as soon as a predetermined number of switches are "closed" **or** the allocated time has expired.
- >> 42 - 49 **PROPRIETARY:** Proprietary Audits are used for *Future Expansion* or *Programming*.
- 50 **BASE REPLAY:** Provides the current base *Replay Level Score*.
- 51 **LEFT FLIPPER USED:** Provides the total number of times the **Left Flipper Button** (Dedicated Switch 1) was pushed in **Game Mode**.
- 52 **RIGHT FLIPPER USED:** Provides the total number of times the **Right Flipper Button** (Dedicated Switch 3) was pushed in **Game Mode**.
- >> 53 - 54 **PROPRIETARY:** Proprietary Audits are used for *Future Expansion* or *Programming*.
- 55 **0 - 1 MINUTE GAMES:** Provides the total number of games the total game time was between **0:00** and **1:00** minute.
- 56 **1 - 1.5 MINUTE GAMES:** Provides the total number of games the total game time was between **1:00** and **1:30** minutes.
- 57 **1.5 - 2 MINUTE GAMES:** Provides the total number of games the total game time was between **1:30** and **2:00** minutes.
- 58 **2 - 2.5 MINUTE GAMES:** Provides the total number of games the total game time was between **2:00** and **2:30** minutes.
- 59 **2.5 - 3 MINUTE GAMES:** Provides the total number of games the total game time was between **2:30** and **3:00** minutes.
- 60 **3 - 3.5 MINUTE GAMES:** Provides the total number of games the total game time was between **3:00** and **3:30** minutes.
- 61 **3.5 - 4 MINUTE GAMES:** Provides the total number of games the total game time was between **3:30** and **4:00** minutes.
- 62 **4 - 5 MINUTE GAMES:** Provides the total number of games the total game time was between **4:00** and **5:00** minutes.
- 63 **5 - 6 MINUTE GAMES:** Provides the total number of games the total game time was between **5:00** and **6:00** minutes.
- 64 **6 - 8 MINUTE GAMES:** Provides the total number of games the total game time was between **6:00** and **8:00** minutes.
- 65 **8 - 10 MINUTE GAMES:** Provides the total number of games the total game time was between **8:00** and **10:00** minutes.
- 66 **10 - 15 MINUTE GAMES:** Provides the total number of games the total game time was between **10:00** and **15:00** minutes.
- 67 **15+ MINUTE GAMES:** Provides the total number of games the total game time was **15:00** and over.
- 68 **RECENT REPLAY PERCENT:** *Percent figured with programming thresholds for a determined number of games (again based on programming thresholds). The percentage reflects replay total awards for exceeding replay score levels.*

Sec. 3: Go To Audits

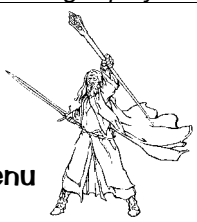



Feature Audits (01-154)

To initiate, from the **AUDITS MENU**, select the "LOTR" *Icon* with either the **Red "LEFT"** or **Green "RIGHT" Buttons** and press the **Black "ENTER" Button**. Select and *activate* either of the ">>" *Mini-Icons* to view the next or previous Audit in this group. The display will describe the **Audit Number**, **Audit Name** and the **Current Audit Total** (Value). The current Audit will remain in the display until the next Audit is viewed or when this Menu is exited. **Audits Definition: Programming Use Only.** *The proprietary information provides the total number of times a feature was started, awarded, lit, played and/or completed (awarded); also, the total number of Switch Closures during certain modes or features are tracked (a predetermined single/multiple variations of switch closures are used to determine the lighting and/or completion of the feature stated).*

FEATURE AUDIT TABLE



FEATURE AUDITS

01-154  = 

*** PROGRAMMING USE ONLY ***

UNLABELED BOXES ARE FOR FUTURE EXPANSION.

01	LEFT VUK	40	DWARF RINGS COMPLETD	79	FOTR MB 2+ STARTED	118	DESTROY RING STARTED
02	LEFT VUK DIRECT HIT	41	ELF RINGS COMPLETED	80	FOTR MB WON	119	DESTROY RING WON
03	LEFT ORBIT	42	RING MANIA STARTED	81	TROLL HITS	120	GIFT OF THE ELVES LT
04	LEFT RAMP	43	RING MANIA 2+ STARTED	82	TROLL KILLS	121	GIFT EXTRA BALL
05	CENTER LOOP	44	MANIA RINGS COLLECTD	83	BALROG HITS	122	GIFT RING MB
06	SPINS	45	MANIA SHOTS COMPLETD	84	BRIDGE CROSSES	123	GIFT BIG POINTS
07	RING	46	MANIA 1X JACKPOT	85	BALROG KILLS	124	GIFT SPECIAL
08	RIGHT VUK	47	MANIA 2X JACKPOT	86	SWORD LOCKS LIT	125	GIFT 2X SCORING
09	RT VUK BEHIND	48	MANIA 3X JACKPOT	87	SWORD LOCK 1	126	GIFT SUPER MANIA
10	RIGHT RAMP	49	MANIA 4X JACKPOT	88	SWORD LOCK 2	127	GIFT WIZARD MODE
11	RINGWRAITH	50	MANIA 5X JACKPOT	89	TTT MB STARTED	128	PALANTIR LIT
12	RIGHT ORBIT	51	MANIA EXTRA BALL LIT	90	TTT MB 2+ STARTED	129	PALANTIR COLLECTED
13	SPOT RING TARGET	52	RING MODE LIT	91	TTT 1X JACKPOT	130	RING MB RING SHOTS
14	ORTHANC ARRIVALS	53	ESCAPE MODE STARTED	92	TTT 2X JACKPOT	131	RING MB S. JACKPOTS
15	BARAD-DÛR ARRIVALS	54	ESCAPE MODE WON	93	TTT 3X JACKPOT	132	RING MB 2.5M
16	ORC LANES	55	BATTLE MODE STARTED	94	TTT 4X JACKPOT	133	RING MB LIGHT E. BALL
17	POP HITS	56	BATTLE MODE WON	95	TTT 5X JACKPOT	134	RING MB 5M
18	LEFT OUTLANE	57	WARG MODE STARTED	96	TTT 6X JACKPOT	135	RING MB LITE SPECIAL
19	LEFT INLANE	58	WARG MODE WON	97	TTT 7X JACKPOT	136	RING MB 7.5M
20	RIGHT INLANE	59	ENT MODE STARTED	98	TTT STAGES SURVIVED	137	SRMMB RING SHOTS
21	RIGHT OUTLANE	60	ENT MODE WON	99	TTT S. JACKPOT LIT	138	SRMMB SHOTS COMPLETE
22	LANE S. S. PICKED	61	SHELOB MODE STARTED	100	TTT SJP COLLECTED	139	SRMMB JACKPOTS
23	TOWER S. S. PICKED	62	SHELOB MODE WON	101	TTT MB WON	140	SRMMB TOTAL JACKPT X
24	FLIPPER S. S. PICKED	63	WITCHKING MODE STRTD	102	PATH ADVANCED	141	SRMMB SUPER JACKPOTS
25	LANE SKILL SHOT MADE	64	WITCHKING MODE WON	103	PATH ACCESSED	142	VALINOR STARTED
26	LANE S. S. MADE	65	BOOK MODE LIT	104	PATH TIME SOULS	143	BALROG STARTED
27	TOWER S. S. MADE	66	MOOK MODE STARTED	105	PATH UNLIT SOULS	144	BALROG HITS
28	FLIPPER S. S. MADE	67	BOOK MODE JACKPOTS	106	PATH LIT SOULS	145	CAVE SHOTS
29	ORC COMPLETED	68	BOOK MODE WON	107	PATH BLINKING SOULS	146	CAVE BALROG
30	HUMAN RINGS COLLECTD	69	MYSTERY LIT	108	SOULS COMPLETED	147	CAVE SUPER SPINNER
31	DWARF RINGS COLLECTD	70	MYSTERY COLLECTED	109	ROTK MB STARTED	148	CAVE SUPER POPS
32	ELF RINGS COLLECTED	71	MYSTERY E. B. LIT	110	ROTK MB 2+ STARTED	149	CAVE SUPER RAMPS
33	RINGS SPOTTED	72	MYSTERY SPECIAL LIT	111	ROTK JACKPOTS	150	CAVE SUPER LOOPS
34	HUMAN RING BONUS	73	GOLLUM MULTIBALL LIT	112	ROTK LEVELS COMPLETE	151	CAVE SUPER EVERYTHING
35	DWARF RING BONUS	74	GOLLUM MBALL STARTED	113	ROTK MULT INCREASED	152	BARAD-DÛR HOLD RING VALUE
36	ELF RING BONUS	75	GOLLUM MBALL 2+ STRTD	114	ROTK S. JACKPOT LIT	153	BARAD-DÛR LIGHT EXTRA BALL
37	RING COMBOS	76	FELLOWSHIP COLLECTED	115	ROTK SJP COLLECTED	154	BARAD-DÛR POINTS
38	RING COMBO THRSHDS	77	FELLOWSHIP COMPLETED	116	ROTK MB WON		
39	HUMAN RINGS COMPLETD	78	FOTR MB STARTED	117	DESTROY RING LIT		

Note: Audits are subject to change (with or without notice).

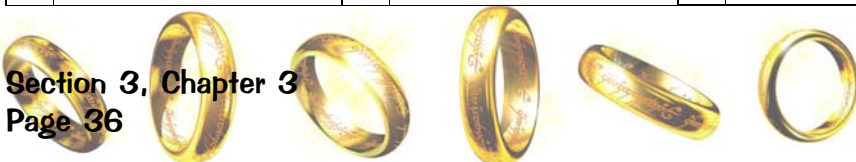



Go To Printer Menu (OPTIONAL USE ONLY)

Operational Usage Note: The use of the following Sub-Menus are **OPTIONAL** and provided as a convenience only. **No special equipment was included with your Pinball Game.** To initiate, from the **AUDITS MENU**, select the "PRNT" *Icon* with either the **Red "LEFT"** or **Green "RIGHT"** **Button** and press the **Black "ENTER"** **Button**. The **PRINTER MENU** appears. A **Tournament Serial Interface (TSI) Board** and a **RS-232 Communication Device** (which can download serial information) are required for proper operation of these Sub-Menus. Entering the menus & selecting/activating the *Icons* without the equipment mentioned, will not affect the Pinball Game nor the operation of the **Portals™ Service Menu System** in any way. An optional Printer Kit is available for purchase (contact your local distributor).



Quick Printout

To initiate, from the **PRINTER MENU**, select the "QUIK" *Icon* with either the **Red** or **Green Button** and press the **Black Button**. Select either the "-" or "+" *Mini-Icon* and press the **Black Button** to start the printout. Per the display instruction, the **Start Button** can also be pressed to start the printout. Only the **Earnings Audits** can be retrieved and/or printed for further processing.



Full Printout

To initiate, from the **PRINTER MENU**, select the "ALISON" *Icon* with either the **Red** or **Green Button** and press the **Black Button**. Select either the "-" or "+" *Mini-Icon* and press the **Black Button** to start the download. Per the display instruction, the **Start Button** can also be pressed to start the download. All **Earnings, Standard, Feature & Tournament Audits** can be retrieved and/or printed for further processing.



Reset Printer

To initiate, from the **PRINTER MENU**, select the "RESET" *Icon* with either the **Red** or **Green Button** and press the **Black Button**. Select either the "-" or "+" *Mini-Icon* and press the **Black Button** to clear the "Nº of copies printed" count total appearing in the display. **Operational Usage Note:** Activating the "QUIK" *Icon* (in the previous Quick Printout) **without the special equipment and unique software, will still provide a "count total" in this Reset Printer Menu, which does not affect the operation of the Portals™ Service Menu System in any way.** Activating this "RESET" *Icon* will reset the "count total" in the display to **00**.

Sec. 3: Go To Audits



FEATURE AUDIT ABBREVIATIONS USED IN THIS CHAPTER:

FOTR : The Fellowship of the Ring™		TTT : The Two Towers™		ROTK : The Return of the King™	
	E. B. : Extra Ball		LT : Lit		MB : Multiball
S. S. : Skill Shot		S. JACKPOT / SJP : Super Jackpot		SRMMB : Super Ring Mania Multiball	



For how to **RESET Audits**, see **Section 3, Chapter 6, GO TO RESET MENU.**



Go To Audits Menu



STARTING METER Reading :

STARTING METER Date (MM/DD/YR) :

AUDITOR'S NAME :

CURRENT VOLUME SETTING:

CURRENT METER Reading :

AUDIT Date (MM/DD/YR) :

CPU Version :

DISPLAY Version :

GAME LOCATION NAME :

EARNINGS & STANDARD AUDIT TABLES

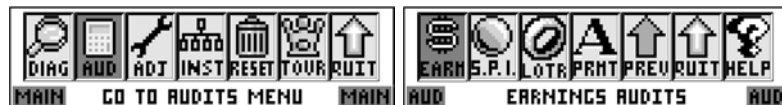

EARNINGS AUDITS 01-14 =

01	TOTAL PAID CREDITS
02	FREE GAME PERCENTAGE
03	AVERAGE BALL TIME
04	AVERAGE GAME TIME
05	COINS THRU LEFT SLOT

06	COINS THRU RIGHT SLOT
07	COINS THRU CENTER SLOT
08	COINS THRU 4TH SLOT
09	COINS THRU 5TH SLOT
10	COINS THRU 6TH SLOT

11	TOTAL COINS
12	TOTAL EARNINGS
13	METER CLICKS
14	SOFTWARE METER



STANDARD AUDITS 01-68 =

01	TOTAL BALLS PLAYED
02	TOTAL EXTRA BALLS
03	EXTRA BALL PERCENT
04	REPLAY 1 AWARDS
05	REPLAY 2+ AWARDS
06	TOTAL REPLAYS
07	REPLAY PERCENT
08	TOTAL SPECIALS
09	SPECIAL PERCENT
10	TOTAL MATCHES
11	HIGH SCORE AWARDS
12	HIGH SCORE PERCENT
13	TOTAL FREE PLAYS
14	TOTAL PLAYS
15	0-1.9M SCORES
16	2M-3.9M SCORES
17	4M-5.9M SCORES
18	6M-7.9M SCORES
19	8M-9.9M SCORES
20	10M-12.4M SCORES
21	12.5M-14.9M SCORES
22	15M-17.4M SCORES
23	17.5M-19.9M SCORES
24	20M-22.4M SCORES

25	22.5M-24.9M SCORES
26	25M-34.9M SCORES
27	35M-49.9M SCORES
28	50M-74.9M SCORES
29	75M-99.9M SCORES
30	100M-149.9M SCORES
31	150M+ SCORES
32	AVERAGE SCORES
33	SERVICE CREDITS
34	BALL SEARCH STARTED
35	LOST BALL FEEDS
36	LOST BALL GAME STARTS
37	LEFT DRAINS
38	CENTER DRAINS
39	RIGHT DRAINS
40	TILTS
41	TOTAL BALLS SAVED
42	PROPRIETARY
43	PROPRIETARY
44	PROPRIETARY
45	PROPRIETARY
46	PROPRIETARY
47	PROPRIETARY
48	PROPRIETARY

49	PROPRIETARY
50	BASE REPLAY
51	LEFT FLIPPER USED
52	RIGHT FLIPPER USED
53	PROPRIETARY
54	PROPRIETARY
55	0-1 MINUTE GAMES
56	1 - 1.5 MINUTE GAMES
57	1.5 - 2 MINUTE GAMES
58	2 - 2.5 MINUTE GAMES
59	2.5 - 3 MINUTE GAMES
60	3 - 3.5 MINUTE GAMES
61	3.5 - 4 MINUTE GAMES
62	4 - 5 MINUTE GAMES
63	5 - 6 MINUTE GAMES
64	6 - 8 MINUTE GAMES
65	8 - 10 MINUTE GAMES
66	10 - 15 MINUTE GAMES
67	15+ MINUTE GAMES
68	RECENT REPLAY PERCENT

Note: Audits are subject to change (with or without notice).

Comments:

FEATURE AUDIT TABLE



FEATURE AUDITS

01-154 =

*** PROGRAMMING USE ONLY ***

UNLABELED BOXES ARE FOR FUTURE EXPANSION.

01	LEFT VUK	40	DWARF RINGS COMPLETD	79	FOTR MB 2+ STARTED	118	DESTROY RING STARTED
02	LEFT VUK DIRECT HIT	41	ELF RINGS COMPLETED	80	FOTR MB WON	119	DESTROY RING WON
03	LEFT ORBIT	42	RING MANIA STARTED	81	TROLL HITS	120	GIFT OF THE ELVES LT
04	LEFT RAMP	43	RING MANIA 2+ STARTED	82	TROLL KILLS	121	GIFT EXTRA BALL
05	CENTER LOOP	44	MANIA RINGS COLLECTD	83	BALROG HITS	122	GIFT RING MB
06	SPINS	45	MANIA SHOTS COMPLETD	84	BRIDGE CROSSES	123	GIFT BIG POINTS
07	RING	46	MANIA 1X JACKPOT	85	BALROG KILLS	124	GIFT SPECIAL
08	RIGHT VUK	47	MANIA 2X JACKPOT	86	SWORD LOCKS LIT	125	GIFT 2X SCORING
09	RT VUK BEHIND	48	MANIA 3X JACKPOT	87	SWORD LOCK 1	126	GIFT SUPER MANIA
10	RIGHT RAMP	49	MANIA 4X JACKPOT	88	SWORD LOCK 2	127	GIFT WIZARD MODE
11	RINGWRAITH	50	MANIA 5X JACKPOT	89	TTT MB STARTED	128	PALANTIR LIT
12	RIGHT ORBIT	51	MANIA EXTRA BALL LIT	90	TTT MB 2+ STARTED	129	PALANTIR COLLECTED
13	SPOT RING TARGET	52	RING MODE LIT	91	TTT 1X JACKPOT	130	RING MB RING SHOTS
14	ORTHANC ARRIVALS	53	ESCAPE MODE STARTED	92	TTT 2X JACKPOT	131	RING MB S. JACKPOTS
15	BARAD-DÛR ARRIVALS	54	ESCAPE MODE WON	93	TTT 3X JACKPOT	132	RING MB 2.5M
16	ORC LANES	55	BATTLE MODE STARTED	94	TTT 4X JACKPOT	133	RING MB LIGHT E. BALL
17	POP HITS	56	BATTLE MODE WON	95	TTT 5X JACKPOT	134	RING MB 5M
18	LEFT OUTLANE	57	WARG MODE STARTED	96	TTT 6X JACKPOT	135	RING MB LITE SPECIAL
19	LEFT INLANE	58	WARG MODE WON	97	TTT 7X JACKPOT	136	RING MB 7.5M
20	RIGHT INLANE	59	ENT MODE STARTED	98	TTT STAGES SURVIVED	137	SRMMB RING SHOTS
21	RIGHT OUTLANE	60	ENT MODE WON	99	TTT S. JACKPOT LIT	138	SRMMB SHOTS COMPLETE
22	LANE S. S. PICKED	61	SHELOB MODE STARTED	100	TTT SJP COLLECTED	139	SRMMB JACKPOTS
23	TOWER S. S. PICKED	62	SHELOB MODE WON	101	TTT MB WON	140	SRMMB TOTAL JACKPT X
24	FLIPPER S. S. PICKED	63	WITCHKING MODE STRTD	102	PATH ADVANCED	141	SRMMB SUPER JACKPOTS
25	LANE SKILL SHOT MADE	64	WITCHKING MODE WON	103	PATH ACCESSED	142	VALINOR STARTED
26	LANE S. S. MADE	65	BOOK MODE LIT	104	PATH TIME SOULS	143	BALROG STARTED
27	TOWER S. S. MADE	66	MOOK MODE STARTED	105	PATH UNLIT SOULS	144	BALROG HITS
28	FLIPPER S. S. MADE	67	BOOK MODE JACKPOTS	106	PATH LIT SOULS	145	CAVE SHOTS
29	ORC COMPLETED	68	BOOK MODE WON	107	PATH BLINKING SOULS	146	CAVE BALROG
30	HUMAN RINGS COLLECTD	69	MYSTERY LIT	108	SOULS COMPLETED	147	CAVE SUPER SPINNER
31	DWARF RINGS COLLECTD	70	MYSTERY COLLECTED	109	ROTK MB STARTED	148	CAVE SUPER POPS
32	ELF RINGS COLLECTED	71	MYSTERY E. B. LIT	110	ROTK MB 2+ STARTED	149	CAVE SUPER RAMPS
33	RINGS SPOTTED	72	MYSTERY SPECIAL LIT	111	ROTK JACKPOTS	150	CAVE SUPER LOOPS
34	HUMAN RING BONUS	73	GOLLUM MULTIBALL LIT	112	ROTK LEVELS COMPLETE	151	CAVE SUPER EVERYTHING
35	DWARF RING BONUS	74	GOLLUM MBALL STARTED	113	ROTK MULT INCREASED	152	BARAD-DÛR HOLD RING VALUE
36	ELF RING BONUS	75	GOLLUM MBALL 2+ STRTD	114	ROTK S. JACKPOT LIT	153	BARAD-DÛR LIGHT EXTRA BALL
37	RING COMBOS	76	FELLOWSHIP COLLECTED	115	ROTK SJP COLLECTED	154	BARAD-DÛR POINTS
38	RING COMBO THRSHLDS	77	FELLOWSHIP COMPLETED	116	ROTK MB WON		
39	HUMAN RINGS COMPLETD	78	FOTR MB STARTED	117	DESTROY RING LIT		

MULTI-WEEK TOURNAMENT AUDIT TABLES

STARTING METER Reading :	STARTING METER Date (MM/DD/YR) :	AUDITOR'S NAME :	CURRENT VOLUME SETTING:		
<input style="width: 100px; height: 20px;" type="text"/>	<input style="width: 100px; height: 20px;" type="text" value="0"/>		<input style="width: 20px; height: 20px;" type="text"/> <input style="width: 20px; height: 20px;" type="text"/>		
CURRENT METER Reading :	AUDIT Date (MM/DD/YR) :	CPU Version :	DISPLAY Version :		
<input style="width: 100px; height: 20px;" type="text"/>	<input style="width: 100px; height: 20px;" type="text" value="0"/>	<input style="width: 100px; height: 20px;" type="text"/>	<input style="width: 100px; height: 20px;" type="text"/>		
01	TOTAL PLAYS	06	NET EARNINGS	11	ACCUM. JACKPOT
02	TOURNAMENT PLAYS	07	ACCUM. TOTAL PLAYS	12	# TOURNAMENTS
03	TOTAL GAME EARNINGS	08	ACCUM. TOUR. PLAYS		
04	TOTAL TOUR. EARNINGS	09	ACCUM. EARNINGS		
05	JACKPOT	10	ACCUM. TOUR EARNINGS		

STARTING METER Reading :	STARTING METER Date (MM/DD/YR) :	AUDITOR'S NAME :	CURRENT VOLUME SETTING:		
<input style="width: 100px; height: 20px;" type="text"/>	<input style="width: 100px; height: 20px;" type="text" value="0"/>		<input style="width: 20px; height: 20px;" type="text"/> <input style="width: 20px; height: 20px;" type="text"/>		
CURRENT METER Reading :	AUDIT Date (MM/DD/YR) :	CPU Version :	DISPLAY Version :		
<input style="width: 100px; height: 20px;" type="text"/>	<input style="width: 100px; height: 20px;" type="text" value="0"/>	<input style="width: 100px; height: 20px;" type="text"/>	<input style="width: 100px; height: 20px;" type="text"/>		
01	TOTAL PLAYS	06	NET EARNINGS	11	ACCUM. JACKPOT
02	TOURNAMENT PLAYS	07	ACCUM. TOTAL PLAYS	12	# TOURNAMENTS
03	TOTAL GAME EARNINGS	08	ACCUM. TOUR. PLAYS		
04	TOTAL TOUR. EARNINGS	09	ACCUM. EARNINGS		
05	JACKPOT	10	ACCUM. TOUR EARNINGS		

STARTING METER Reading :	STARTING METER Date (MM/DD/YR) :	AUDITOR'S NAME :	CURRENT VOLUME SETTING:		
<input style="width: 100px; height: 20px;" type="text"/>	<input style="width: 100px; height: 20px;" type="text" value="0"/>		<input style="width: 20px; height: 20px;" type="text"/> <input style="width: 20px; height: 20px;" type="text"/>		
CURRENT METER Reading :	AUDIT Date (MM/DD/YR) :	CPU Version :	DISPLAY Version :		
<input style="width: 100px; height: 20px;" type="text"/>	<input style="width: 100px; height: 20px;" type="text" value="0"/>	<input style="width: 100px; height: 20px;" type="text"/>	<input style="width: 100px; height: 20px;" type="text"/>		
01	TOTAL PLAYS	06	NET EARNINGS	11	ACCUM. JACKPOT
02	TOURNAMENT PLAYS	07	ACCUM. TOTAL PLAYS	12	# TOURNAMENTS
03	TOTAL GAME EARNINGS	08	ACCUM. TOUR. PLAYS		
04	TOTAL TOUR. EARNINGS	09	ACCUM. EARNINGS		
05	JACKPOT	10	ACCUM. TOUR EARNINGS		

STARTING METER Reading :	STARTING METER Date (MM/DD/YR) :	AUDITOR'S NAME :	CURRENT VOLUME SETTING:		
<input style="width: 100px; height: 20px;" type="text"/>	<input style="width: 100px; height: 20px;" type="text" value="0"/>		<input style="width: 20px; height: 20px;" type="text"/> <input style="width: 20px; height: 20px;" type="text"/>		
CURRENT METER Reading :	AUDIT Date (MM/DD/YR) :	CPU Version :	DISPLAY Version :		
<input style="width: 100px; height: 20px;" type="text"/>	<input style="width: 100px; height: 20px;" type="text" value="0"/>	<input style="width: 100px; height: 20px;" type="text"/>	<input style="width: 100px; height: 20px;" type="text"/>		
01	TOTAL PLAYS	06	NET EARNINGS	11	ACCUM. JACKPOT
02	TOURNAMENT PLAYS	07	ACCUM. TOTAL PLAYS	12	# TOURNAMENTS
03	TOTAL GAME EARNINGS	08	ACCUM. TOUR. PLAYS		
04	TOTAL TOUR. EARNINGS	09	ACCUM. EARNINGS		
05	JACKPOT	10	ACCUM. TOUR EARNINGS		

MULTI-WEEK TOURNAMENT AUDIT TABLES

STARTING METER Reading :	STARTING METER Date (MM/DD/YR) :	AUDITOR'S NAME :	CURRENT VOLUME SETTING:																				
<input type="text"/>	<input type="text"/>		<input type="text"/>																				
CURRENT METER Reading :	AUDIT Date (MM/DD/YR) :	CPU Version :	DISPLAY Version :																				
<input type="text"/>	<input type="text"/>	<input type="text"/>	<input type="text"/>																				
<table border="1" style="width: 100%; border-collapse: collapse;"> <tr><td style="width: 20px;">01</td><td>TOTAL PLAYS</td></tr> <tr><td>02</td><td>TOURNAMENT PLAYS</td></tr> <tr><td>03</td><td>TOTAL GAME EARNINGS</td></tr> <tr><td>04</td><td>TOTAL TOUR. EARNINGS</td></tr> <tr><td>05</td><td>JACKPOT</td></tr> </table>		01	TOTAL PLAYS	02	TOURNAMENT PLAYS	03	TOTAL GAME EARNINGS	04	TOTAL TOUR. EARNINGS	05	JACKPOT	<table border="1" style="width: 100%; border-collapse: collapse;"> <tr><td style="width: 20px;">06</td><td>NET EARNINGS</td></tr> <tr><td>07</td><td>ACCUM. TOTAL PLAYS</td></tr> <tr><td>08</td><td>ACCUM. TOUR. PLAYS</td></tr> <tr><td>09</td><td>ACCUM. EARNINGS</td></tr> <tr><td>10</td><td>ACCUM. TOUR EARNINGS</td></tr> </table>		06	NET EARNINGS	07	ACCUM. TOTAL PLAYS	08	ACCUM. TOUR. PLAYS	09	ACCUM. EARNINGS	10	ACCUM. TOUR EARNINGS
01	TOTAL PLAYS																						
02	TOURNAMENT PLAYS																						
03	TOTAL GAME EARNINGS																						
04	TOTAL TOUR. EARNINGS																						
05	JACKPOT																						
06	NET EARNINGS																						
07	ACCUM. TOTAL PLAYS																						
08	ACCUM. TOUR. PLAYS																						
09	ACCUM. EARNINGS																						
10	ACCUM. TOUR EARNINGS																						
		<table border="1" style="width: 100%; border-collapse: collapse;"> <tr><td style="width: 20px;">11</td><td>ACCUM. JACKPOT</td></tr> <tr><td>12</td><td># TOURNAMENTS</td></tr> <tr><td> </td><td> </td></tr> <tr><td> </td><td> </td></tr> </table>		11	ACCUM. JACKPOT	12	# TOURNAMENTS																
11	ACCUM. JACKPOT																						
12	# TOURNAMENTS																						

STARTING METER Reading :	STARTING METER Date (MM/DD/YR) :	AUDITOR'S NAME :	CURRENT VOLUME SETTING:																				
<input type="text"/>	<input type="text"/>		<input type="text"/>																				
CURRENT METER Reading :	AUDIT Date (MM/DD/YR) :	CPU Version :	DISPLAY Version :																				
<input type="text"/>	<input type="text"/>	<input type="text"/>	<input type="text"/>																				
<table border="1" style="width: 100%; border-collapse: collapse;"> <tr><td style="width: 20px;">01</td><td>TOTAL PLAYS</td></tr> <tr><td>02</td><td>TOURNAMENT PLAYS</td></tr> <tr><td>03</td><td>TOTAL GAME EARNINGS</td></tr> <tr><td>04</td><td>TOTAL TOUR. EARNINGS</td></tr> <tr><td>05</td><td>JACKPOT</td></tr> </table>		01	TOTAL PLAYS	02	TOURNAMENT PLAYS	03	TOTAL GAME EARNINGS	04	TOTAL TOUR. EARNINGS	05	JACKPOT	<table border="1" style="width: 100%; border-collapse: collapse;"> <tr><td style="width: 20px;">06</td><td>NET EARNINGS</td></tr> <tr><td>07</td><td>ACCUM. TOTAL PLAYS</td></tr> <tr><td>08</td><td>ACCUM. TOUR. PLAYS</td></tr> <tr><td>09</td><td>ACCUM. EARNINGS</td></tr> <tr><td>10</td><td>ACCUM. TOUR EARNINGS</td></tr> </table>		06	NET EARNINGS	07	ACCUM. TOTAL PLAYS	08	ACCUM. TOUR. PLAYS	09	ACCUM. EARNINGS	10	ACCUM. TOUR EARNINGS
01	TOTAL PLAYS																						
02	TOURNAMENT PLAYS																						
03	TOTAL GAME EARNINGS																						
04	TOTAL TOUR. EARNINGS																						
05	JACKPOT																						
06	NET EARNINGS																						
07	ACCUM. TOTAL PLAYS																						
08	ACCUM. TOUR. PLAYS																						
09	ACCUM. EARNINGS																						
10	ACCUM. TOUR EARNINGS																						
		<table border="1" style="width: 100%; border-collapse: collapse;"> <tr><td style="width: 20px;">11</td><td>ACCUM. JACKPOT</td></tr> <tr><td>12</td><td># TOURNAMENTS</td></tr> <tr><td> </td><td> </td></tr> <tr><td> </td><td> </td></tr> </table>		11	ACCUM. JACKPOT	12	# TOURNAMENTS																
11	ACCUM. JACKPOT																						
12	# TOURNAMENTS																						

STARTING METER Reading :	STARTING METER Date (MM/DD/YR) :	AUDITOR'S NAME :	CURRENT VOLUME SETTING:																				
<input type="text"/>	<input type="text"/>		<input type="text"/>																				
CURRENT METER Reading :	AUDIT Date (MM/DD/YR) :	CPU Version :	DISPLAY Version :																				
<input type="text"/>	<input type="text"/>	<input type="text"/>	<input type="text"/>																				
<table border="1" style="width: 100%; border-collapse: collapse;"> <tr><td style="width: 20px;">01</td><td>TOTAL PLAYS</td></tr> <tr><td>02</td><td>TOURNAMENT PLAYS</td></tr> <tr><td>03</td><td>TOTAL GAME EARNINGS</td></tr> <tr><td>04</td><td>TOTAL TOUR. EARNINGS</td></tr> <tr><td>05</td><td>JACKPOT</td></tr> </table>		01	TOTAL PLAYS	02	TOURNAMENT PLAYS	03	TOTAL GAME EARNINGS	04	TOTAL TOUR. EARNINGS	05	JACKPOT	<table border="1" style="width: 100%; border-collapse: collapse;"> <tr><td style="width: 20px;">06</td><td>NET EARNINGS</td></tr> <tr><td>07</td><td>ACCUM. TOTAL PLAYS</td></tr> <tr><td>08</td><td>ACCUM. TOUR. PLAYS</td></tr> <tr><td>09</td><td>ACCUM. EARNINGS</td></tr> <tr><td>10</td><td>ACCUM. TOUR EARNINGS</td></tr> </table>		06	NET EARNINGS	07	ACCUM. TOTAL PLAYS	08	ACCUM. TOUR. PLAYS	09	ACCUM. EARNINGS	10	ACCUM. TOUR EARNINGS
01	TOTAL PLAYS																						
02	TOURNAMENT PLAYS																						
03	TOTAL GAME EARNINGS																						
04	TOTAL TOUR. EARNINGS																						
05	JACKPOT																						
06	NET EARNINGS																						
07	ACCUM. TOTAL PLAYS																						
08	ACCUM. TOUR. PLAYS																						
09	ACCUM. EARNINGS																						
10	ACCUM. TOUR EARNINGS																						
		<table border="1" style="width: 100%; border-collapse: collapse;"> <tr><td style="width: 20px;">11</td><td>ACCUM. JACKPOT</td></tr> <tr><td>12</td><td># TOURNAMENTS</td></tr> <tr><td> </td><td> </td></tr> <tr><td> </td><td> </td></tr> </table>		11	ACCUM. JACKPOT	12	# TOURNAMENTS																
11	ACCUM. JACKPOT																						
12	# TOURNAMENTS																						

STARTING METER Reading :	STARTING METER Date (MM/DD/YR) :	AUDITOR'S NAME :	CURRENT VOLUME SETTING:																				
<input type="text"/>	<input type="text"/>		<input type="text"/>																				
CURRENT METER Reading :	AUDIT Date (MM/DD/YR) :	CPU Version :	DISPLAY Version :																				
<input type="text"/>	<input type="text"/>	<input type="text"/>	<input type="text"/>																				
<table border="1" style="width: 100%; border-collapse: collapse;"> <tr><td style="width: 20px;">01</td><td>TOTAL PLAYS</td></tr> <tr><td>02</td><td>TOURNAMENT PLAYS</td></tr> <tr><td>03</td><td>TOTAL GAME EARNINGS</td></tr> <tr><td>04</td><td>TOTAL TOUR. EARNINGS</td></tr> <tr><td>05</td><td>JACKPOT</td></tr> </table>		01	TOTAL PLAYS	02	TOURNAMENT PLAYS	03	TOTAL GAME EARNINGS	04	TOTAL TOUR. EARNINGS	05	JACKPOT	<table border="1" style="width: 100%; border-collapse: collapse;"> <tr><td style="width: 20px;">06</td><td>NET EARNINGS</td></tr> <tr><td>07</td><td>ACCUM. TOTAL PLAYS</td></tr> <tr><td>08</td><td>ACCUM. TOUR. PLAYS</td></tr> <tr><td>09</td><td>ACCUM. EARNINGS</td></tr> <tr><td>10</td><td>ACCUM. TOUR EARNINGS</td></tr> </table>		06	NET EARNINGS	07	ACCUM. TOTAL PLAYS	08	ACCUM. TOUR. PLAYS	09	ACCUM. EARNINGS	10	ACCUM. TOUR EARNINGS
01	TOTAL PLAYS																						
02	TOURNAMENT PLAYS																						
03	TOTAL GAME EARNINGS																						
04	TOTAL TOUR. EARNINGS																						
05	JACKPOT																						
06	NET EARNINGS																						
07	ACCUM. TOTAL PLAYS																						
08	ACCUM. TOUR. PLAYS																						
09	ACCUM. EARNINGS																						
10	ACCUM. TOUR EARNINGS																						
		<table border="1" style="width: 100%; border-collapse: collapse;"> <tr><td style="width: 20px;">11</td><td>ACCUM. JACKPOT</td></tr> <tr><td>12</td><td># TOURNAMENTS</td></tr> <tr><td> </td><td> </td></tr> <tr><td> </td><td> </td></tr> </table>		11	ACCUM. JACKPOT	12	# TOURNAMENTS																
11	ACCUM. JACKPOT																						
12	# TOURNAMENTS																						



STANDARD & FEATURE ADJUSTMENT TABLES

(Review Overview regarding changes)

STANDARD ADJUSTMENTS 01-55

Nr.	ADJUSTMENT NAME	USA DEFAULT	YOUR SETTING
01	REPLAY TYPE	AUTO	
02*	REPLAY PERCENTAGE	10%	
03	REPLAY AWARD	CREDIT	
04*	REPLAY LEVELS	1: 20,000,000	
05	REPLAY BOOST	YES	
06	SPECIAL AWARD	CREDIT	
07*	SPECIAL PERCENTAGE	2%	
08	FREE GAME LIMIT	05	
09*	EXTRA BALL LIMIT	09	
10*	EXTRA BALL PERCENTAGE	25%	
11	GAME PRICING	USA 5	
12	MATCH AWARD	CREDIT	
13*	MATCH PERCENTAGE	9%	
14	BALLS PER GAME	03	
15	TILT WARNINGS	01	
16	CREDIT LIMIT	30	
17	ALLOW HIGH SCORES	YES	
18	GRAND CHAMPION AWARDS	01	
19	HIGH SCORE #1 AWARDS	01	
20	HIGH SCORE #2 AWARDS	00	
21	HIGH SCORE #3 AWARDS	00	
22	HIGH SCORE #4 AWARDS	00	
23*	GRAND CHAMPION SCORE	75,000,000	
24*	DEFAULT HIGH SCORE #1	60,000,000	
25*	DEFAULT HIGH SCORE #2	50,000,000	
26*	DEFAULT HIGH SCORE #3	45,000,000	
27*	DEFAULT HIGH SCORE #4	40,000,000	
28	HSTD RESET COUNT	2,000	

Nr.	ADJUSTMENT NAME	USA DEFAULT	YOUR SETTING
29	HIGH SCORE INITIALS	3 INITIALS	
30	FREE PLAY	NO	
31	CUSTOM MESSAGE	ON	
32	FLASH LAMP POWER	NORMAL	
33	COIL PULSE POWER	NORMAL	
34	KNOCKER VOLUME	NORMAL	
35	GAME RESTART	YES	
36	BILL VALIDATOR	NO	
37	BKGRND MUSIC VOLUME	01	
38*	FREEZE TIME	OFF	
39	UK POST SAVE ENABLED	NO	
40	TIMED PLUNGER	OFF	
41	FLIPPER BALL LAUNCH	DISABLED	
42	COINDOOR BALL SAVER	NO	
43	COMPETITION MODE	NO	
44	CONSOLATION BALL	YES	
45	FAST BOOT	YES	
46	Q24 OPTION	COIN METER	
47	TICKET DISP. INSTALLED	NO	
48	ALLOW PLAYER COMP. MODE	YES	
49	TECH ALERT WARNING	NEVER	
50	TEAM SCORES	NO	
51	LOCATION ID	00	
52	GAME ID	00	
53	FLIPPER ADJ 1	10	
54	FLIPPER ADJ 2	50	
55	FLIPPER ADJ 3	3	

* Defaults are subject to change during production (especially 02, 04, 07, 09, 10, 13, 23-27 & 38).

Note: If Game & Display ROMs other than USA are installed, along with the proper Dip Switch Settings, different Defaults will appear. If changes are made (or your Defaults are not USA), enter them with pencil in the YOUR SETTING spaces provided for reference.

Sec. 3: Adjustments



Shortcut to Standard Adjustment 31.

FEATURE ADJUSTMENTS 01-35

Nr.	ADJUSTMENT NAME	USA DEFAULT	YOUR SETTING
01	NUM. RING COMBOS-LEVEL	10	
02	TWO TOWERS MBALL DIFF	MODERATE	
03	1ST HARD TTT MB	1	
04	TTT LOCK DIFFICULTY	EX. EASY	
05	PALANTIR DIFFICULTY	EASY	
06	FELLOWSHIP DIFFICULTY	EASY	
07	RING MULTIBALL DIFF	MODERATE	
08	RING MBALL E. BALL MEM	NO	
09	RING MBALL SPECIAL MEM	NO	
10	ELF GIFT E. BALL MEM	YES	
11	ELF GIFT SPECIAL MEM	YES	
12	RING FRENZY E. BALL DIFF	MODERATE	
13	RING FRENZY E. BALL MEM	NO	
14	RING MODE DIFFICULTY	EASY	
15	PATHS OF THE DEAD DIFF	MODERATE	
16	MYSTERY DIFFICULTY	HARD	
17	MYSTERY EB MEM	NO	

Nr.	ADJUSTMENT NAME	USA DEFAULT	YOUR SETTING
18	MYSTERY SPECIAL MEM	NO	
19	SPOT RING DIFF.	EASY	
20	ELF RING SPOTTING	MODERATE	
21	DWARF RING SPOTTING	EASY	
22	HUMAN RING SPOTTING	MODERATE	
23	FELLOWSHIP MBALL DIFF	MODERATE	
24	ROTK MBALL DIFF	MODERATE	
25	CONSOLATION MYSTERY	YES	
26	ALLOW VOLUME EFFECTS	YES	
27	GAME START BALROG ROAR	YES	
28	BARAD-DÛR DIFFICULTY	MODERATE	
29	BARAD-DÛR E. B. MEMORY	YES	
30	SPOT FELLOWSHIP MBRS.	YES	
31	GOLLUM'S CAVE DIFF.	MODERATE	
32	EARLY BARAD-DÛR CRASH	YES	
33	CAVE TROLL SEQUENCE	OFF	
34	CONSOLATION BALROG	BOTH	
35	DESTROY RING # BALLS	1	



Go To Adjustments Menu

Overview

The Portals™ Service Menu System provides **90** Adjustments to vary Game Functions to customize for your particular needs. The Adjustments are divided into 2 groups: • **Standard Adjustments (01-55)** and • **Feature Adjustments (01-35)**. Game code may get upgraded during production; compare all Adjustments in the display with the manual and make any corrections to the Adjustment Table (*previous page*), as necessary. Adjustments are subject to change (*with or without notice*). To view Adjustments in the display, enter the **Portals™ Service Menu System**. When a change is made and then the next / previous Adjustment is selected (*or the Sub-Menu is exited*), the display will momentarily flash **REQUEST INSTALLED**. For **further customization of Game Play Difficulty or Game Play Type** or how to **RESET ONLY the Adjustments**, see **Section 3, Chapter 5, GO TO INSTALLS MENU**.



Important: The **Coin Door** must be **OPEN** allowing the **Memory Protect Switch** to be disabled, so any Adjustment changes can be made.



EXPLANATION & USAGE OF COMMON LARGE & MINI-ICONS USED IN VARIOUS MENUS & SUB-MENUS:



These **non-selectable icons** appear in the selected Menu only when there are **MORE** icons to the **LEFT** or to the **RIGHT** available for selection.



Select and activate to return to the **PREVIOUS** Menu.



Select and activate to **QUIT**, exits & returns to the **Attract Mode**.



Select and activate to view **HELP** Screens of the current Menu*.



Select and activate to: Move **LEFT** or **RIGHT**, select previous / next or move backwards / forwards.



DECREMENT (-) or **INCREMENT (+)** displayed value or select previous / next.

* **Help Note:** An explanation of each Mini-Icon at that menu level will cycle continuously. To exit a display where no Mini-Icons are available for selection, pressing any button will exit the display.



GO TO ADJUSTMENTS MENU

After entering **Portals™**, the **MAIN MENU** now appears. Select the "**ADJ**" Icon in the **MAIN MENU** with either the **Red "LEFT"** or **Green "RIGHT"** Buttons (the **Flipper Buttons** operates in the same manner) and press the **Black "ENTER"** Button (the **Start Button** operates in the same manner). The **ADJUSTMENTS MENU** appears. Continue through this chapter for the explanation & usage of the *Icons* in the **ADJUSTMENTS MENU**.



Standard Adjustments (01-55)

To initiate, from the **ADJUSTMENTS MENU**, select the "**S.P.I.**" Icon with either the **Red "LEFT"** or **Green "RIGHT"** Buttons and press the **Black "ENTER"** Button. Select and activate either of the ">>" Mini-Icons to view the next or previous Adjustment in this group. Select and activate either of the "-" or "+" Mini-Icons to change the setting, if desired (*the Default Setting is noted in the definitions below*). The display will describe the **Adjustment Number**, **Adjustment Name** and the **Current Adjustment Setting**. The current Adjustment will remain in the display until the next Adjustment is view or when this Menu is exited.

WARNING: Changes made in any Adjustments will be lost after a **FACTORY RESET** or removal of the **CPU/Sound Board Batteries**.

Nr.

STANDARD ADJUSTMENT NAME: Definition

REPLAY TYPE: Set to **AUTO**, **DYNAMIC**, **FIXED** or **NONE**. Default is **AUTO**. Selecting **NONE** will make Standard Adjustments **2-5 NOT AVAILABLE**. Selecting **FIXED** will make Standard Adjustment **2 NOT AVAILABLE**. If selected **AUTO**, **DYNAMIC** or **FIXED**, you will need to then select the number of Replay Levels and Score Threshold (*in Standard Adj. 4*) desired for the player to receive a Replay Award (*select type in Standard Adj. 3*). The Default Score appears as a starting point after the Level amount is selected. **AUTO & DYNAMIC** will then get based on the Replay Percentage (*in Standard Adjustment 2*).

01

• Select **FIXED** to give the player a Replay Award as the Score Threshold is reached. This Score Threshold **will not** adjust up or down. • Select **AUTO** to give the player a Replay Award as the Score Threshold is reached. This Score Threshold **will automatically** adjust up or down based on the Replay Percentage chosen (*in Std. Adj. 2*). The game periodically adjusts based upon the Player Base Skill Level. • Select **DYNAMIC** to give the player a Replay Award as the Score Threshold is reached. This Score Threshold will go down every game based on the Replay Percentage selected. For (*Dynamic*) example, if the Score Threshold is 50,000,00 and the Replay Percentage selected is 10%, every game a player does not reach the Score Threshold, the score to reach will drop by 5,000,000 (10% of 50M). This will continue every game until the Threshold Score is reached. Thus, if the score then drops to 15,000,000 after 7 games and is then achieved, the Replay Award is given. The original Score Threshold is added to 15,000,000 and is now 65,000,000. It will then take the same player 10 games to reach 15,000,000.

02

REPLAY PERCENTAGE: Set between **01% - 50**. Default is **10%**. This Adjustment is required if Standard Adjustment 1 is set to **AUTO** or **DYNAMIC**.

Standard Adjustments 03-11 continued on the next page.

Go To
Adjustments Menu





03 REPLAY AWARD: Set to EXTRA BALL, CREDIT, TICKET* or TOKEN*. Default is CREDIT. Select EXTRA BALL if awarding a CREDIT, TICKET/TOKEN is prohibited in your area.

*TICKET or TOKEN is selected, the game will require an optional Ticket or Token Dispenser If selected Token, then Standard Adjustment 46, Q24 Option, must be changed accordingly.

04 REPLAY LEVELS: Set between 1 - 4 for the number of Replay Levels to be active. Default is 1. A "Drop-Down" Table appears showing Replay Level 1. Adjust the Replay Level between 10M - 9.99B (Default Score appears as a starting point) using the "-" or "+" Mini-Icons, then use the ">>" Mini-Icon to go to next Level (if selected more than 1) and select the next highest Threshold Score(s) desired.

REPLAY BOOST: Set to YES or NO. Default is YES. This Adjustment works only when Standard Adjustment 1, Replay Type, is set to FIXED or AUTO.

05 When set to YES, while FIXED or AUTO maintains the Replay Levels, Replay Boost works as follows: If the Replay Level is 7,000,000 (regardless of the Replay Percentage), and the Player scores 20M, and receives the Replay Award, the next game the Current Replay Level is added to this base. Thus the next game, the Replay Level is 14,000,000. The Player agains scores 20M. The next game the Player will need to achieve 21,000,00 to earn the Replay Award. If the Player does not achieve 21,000,000, the next game reverts back to the original 7,000,000 or the new adjusted level maintained by the Fixed or Autopercentageing Feature.

06 SPECIAL AWARD: Set to EXTRA BALL, CREDIT, TICKET*, TOKEN* or POINTS. Default is CREDIT. Select EXTRA BALL or POINTS if awarding a CREDIT or TICKET/TOKEN is prohibited in your area.

07 SPECIAL PERCENTAGE: Set between 1% - 5%. Default is 2%. This adjustment allows the operator to adjust how frequently the Special Feature is made available to the player.

08 FREE GAME LIMIT: Set between 01 - 09, NO FREE GAMES or UNLIMITED. Default is 05. Set the maximum number of Free Games that may be accumulated per game.

09 EXTRA BALL LIMIT: Set between 01 - 09, NO EXTRA BALLS or UNLIMITED. Default is 09. Set the number of Extra Balls that may be accumulated per game.

10 EXTRA BALL PERCENTAGE: Set between 01% - 50%. Default is 25%. This adjustment allows the operator to adjust how frequently the Extra Ball Feature is made available to the player.

11 GAME PRICING: There are two (2) methods available for Coin Switch Programming: Standard & Custom. Set between USA 1 thru EURO 12 or CUSTOM. USA Factory Default Setting is USA 5.

Sec. 3: Adjustments

The Dip Switch Settings (Sw. 300) on the CPU/Sound Board for each Country must match with what is shown in the USA & Int'l. Standard Pricing Select Tables for your country to have correct operation (see the next page). For a Standard Selection (USA or International): Select & activate either the "-" or "+" Mini-Icons to move backward or forward in the Display; With your choice appearing in the display, select & activate the ">>" Mini-Icon to advance and "lock-in" the change (display will momentarily flash REQUEST INSTALLED).

If CUSTOM is selected (appears in display), after selecting & activating any Mini-Icon (except for "-" or "+"), the display will momentarily flash REQUEST INSTALLED with the display "LEFT COIN: 0 PULSE" appearing. Use the "<<" or ">>" Mini-Icons to select the next choice (see Table Examples below) and the "-" or "+" Mini-Icons to customize the PULSES, CREDITS & CLICKS from 0 to 99.

The prescribed number of PULSES required for 1 CREDIT must be set according to the Pricing Scheme desired. Some simple calculations are required to get the proper set-up. After customizing, test the set-up with appropriate Coins or Bills and adjust, if necessary. Note: Clicks can be changed if an optional Coin Meter is installed.

Table with 14 columns: LEFT COIN, CENTER COIN, RIGHT COIN, FOURTH COIN, ONE CREDIT, BONUS 1, BONUS 2, BONUS 1, BONUS 2, LEFT COIN, CENTER COIN, RIGHT COIN, FOURTH COIN. Example 1 values: 25c, \$1.00, 25c, Not Used, 1/50c, 2/75c, 3/\$1.00, 3, 12, 3, 1, 4, 0, 0, 0, 0, 1, 4, 1, 1.

In Example 1, note the LEFT (and RIGHT) COIN: 3 PULSES and ONE CREDIT: 4 PULSES. Since every Coin inserted produces 3 Pulses & every Credit requires 4 Pulses, 2 Coins (50c) will produce 6 Pulses (4 Pulses for the 1st Credit + 2 Pulses remains in escrow). The 3rd Coin (75c) provides another 3 Pulses for a total of 5 Pulses (4 Pulses for the 2nd Credit + 1 Pulse remains in escrow). The 4th Coin (\$1.00) provides another 3 Pulses for a total of 4 Pulses (4 Pulses for the 3rd Credit + 0 Pulses remain). The CENTER COIN: 12 PULSES is set this way (with a Bill Validator attached); every \$1-Bill inserted produces 12 Pulses or 3 Credits.

Table with 14 columns: LEFT COIN, CENTER COIN, RIGHT COIN, FOURTH COIN, ONE CREDIT, BONUS 1, BONUS 2, BONUS 1, BONUS 2, LEFT COIN, CENTER COIN, RIGHT COIN, FOURTH COIN. Example 2 values: 25c, \$1.00, 25c, Not Used, 1/50c, 2/75c, 7/\$2.00, 3, 12, 3, 1, 4, 24, 0, 1, 0, 1, 4, 1, 1.

In Example 2, similar to Example 1, however, BONUS CREDITS are implemented. In addition to receiving 3 plays for every \$1.00, the player is awarded an extra Credit for every 2nd dollar inserted before game start.

Table with 14 columns: LEFT COIN, CENTER COIN, RIGHT COIN, FOURTH COIN, ONE CREDIT, BONUS 1, BONUS 2, BONUS 1, BONUS 2, LEFT COIN, CENTER COIN, RIGHT COIN, FOURTH COIN. Example 3 values: 25c, \$1.00, 25c, Not Used, 1/25c, 6/\$1.00, 13/\$2.00, 5, 20, 5, 0, 4, 20, 40, 1, 0, 1, 4, 1, 1.

In Example 3, a Pricing Scheme for a cheaper game is shown. An extra Pulse is put in escrow for every 25c, thus at 4X 25c inserted, another Credit is given, and the BONUS 1: 20 PULSES threshold is also met, so 6/ \$1.00 is achieved. BONUS 2: 40 PULSES is set, so when this threshold is met with \$2.00, 13 Credits are produced.

Table with 14 columns: LEFT COIN, CENTER COIN, RIGHT COIN, FOURTH COIN, ONE CREDIT, BONUS 1, BONUS 2, BONUS 1, BONUS 2, LEFT COIN, CENTER COIN, RIGHT COIN, FOURTH COIN. Example 4 values: 10p, 50p, £1, 20p, 1/30p, 2/50p, 5/£1, 1, 6, 15, 2, 3, 0, 0, 0, 0, 1, 4, 1, 1.

In Example 4, a Pricing Scheme using a different currency (i.e. British Sterling) is shown to provide another way coins (or tokens) can be utilized to custom tailor to your own needs.

Standard Adjustment 11, Custom Pricing, continued on the next page.





USA & International Standard Pricing Select Tables

Table with columns: CPU/SOUND BOARD DIP SWITCH 300 SETTING, COUNTRY SETTING OPTION(S), COIN MECHANISMS (SWITCHES) COINS THRU ... SLOT: LEFT CENTER RIGHT 4TH, PRICING SCHEME, Requires SPI Coin Card(s) Part Number. Rows include USA 1-8, Austria Euro 9, Australia 1-2, Belgium Euro 1, Canada, Denmark 1-2, Finland Euro 8, France Euro 10, Germany 1-3, Greece Euro 6, Italy 1-2, Netherlands Euro 3, New Zealand 1-2, Norway 1-2, Portugal, Spain Euro 3, Sweden 1-2, Switzerland 1-2, UK 1-6.

Sec. 3: Adjustments

Note: The Country Setting Option above noted with "«" & "»" denotes the Factory Default Setting (subject to change).

Std. Adj. 11, Custom Pricing, and Std. Adj. 12-31 continued on the next page.

Go To Adjustments Menu





Euro Summary Pricing Select Table

Pos.	1	2	3	4	5	6	7	8	Alternate Settings	LEFT	CENTER	RIGHT	4TH			
ON	S	E	E	A	B	O	V	E	Euro 1					1 / €50		755-5401-01
OFF	S	E	T	T	I	N	G	S	Euro 2					1 / €50	5 / €2.00	755-5401-02
									Euro 3					1 / €50	3 / €1.00	755-5401-03
									Euro 4					1 / €50	6 / €2.00	755-5401-04
									Euro 5					1 / €50	3 / €1.00	755-5401-05
									Euro 6	€50	€1.00	€2.00	optional	2 / €50		755-5401-06
									Euro 7				optional	1 / €1.00	5 / €4.00	755-5401-07
									Euro 8					1 / €1.00	3 / €2.00	755-5401-08
									Euro 9					1 / €1.00	2 / €1.50	755-5401-09
									Euro 10					1 / €1.00	3 / €2.00	755-5401-10
									Euro 11					1 / €1.00	4 / €2.00	755-5401-11
									Euro 12					2 / €1.00	9 / €4.00	755-5401-12

12 **MATCH AWARD:** Set to **CREDIT**, **TICKET*** or **TOKEN***. Default is **CREDIT**. *read note under Std. Adjustment 3.

13 **MATCH PERCENTAGE:** Set between **0%** - **10%** or **OFF**. Default is **9%**. At **0%** the match display occurs at the end of the game but never awards a Credit. Set to **OFF**, no **Match Animation Feature** is shown.

14 **BALLS PER GAME:** Set between **02** - **10**. Default is **03**. Set the number of balls per game.

15 **TILT WARNINGS:** Set to **00**, **01** or **03**. Default is **01**. Set the number of Plumb Bob Tilt Switch closures before the ball in play is tilted.

16 **CREDIT LIMIT:** Set between **04** - **50**. Default is **30**. Set the maximum credits allowed.

17 **ALLOW HIGH SCORES:** Set to **YES** or **NO**. Default is **YES**. When set to **YES** if a player exceeds any 1 of the 4 High Scores, the player may receive an award (depending on Standard Adjustment 03, **Replay Award**). Set to **NO** to disable this feature. There are 5 High Scores that will allow the player to enter their initials (or name) (see Standard Adjustment 29, **High Score Initials**).

18 **GRAND CHAMPION AWARDS:** Set between **00** - **05**. Default is **01**. Set the number of awards, awarded for exceeding Level 1 (the highest of the five (5) Levels).

19 **HIGH SCORE #1 AWARDS:** Set between **00** - **03**. Default is **01**. Set the number of awards, awarded for exceeding Level 2.

20 **HIGH SCORE #2 AWARDS:** Set between **00** - **02**. Default is **00**. Set the number of awards, awarded for exceeding Level 3.

21 **HIGH SCORE #3 AWARDS:** Set between **00** - **01**. Default is **00**. Set the number of awards, awarded for exceeding Level 4.

22 **HIGH SCORE #4 AWARDS:** Set between **00** - **01**. Default is **00**. Set the number of awards, awarded for exceeding Level 5.

23 **GRAND CHAMPION SCORE:** Set between **1,000,000** - **9,999,000,000** or **00** (increments of 1M). Default is **75,000,000**. Set the desired **High Score Level** to which Level 1 may be achieved. A score higher than the default, cannot be reset by Standard Adjustment 28, **HSTD Reset Count**. The High Score will revert to the Default Score **ONLY** if a **Factory Reset** is done or the batteries are removed from the CPU/Snd. Bd.

24 **DEFAULT HIGH SCORE #1:** Set between **1,000,000** - **9,999,000,000** or **00** (increments of 1M). Default is **60,000,000**. Set the desired **High Score Level** to which Level 2 may be achieved. Read Std. Adj. 28.

25 **DEFAULT HIGH SCORE #2:** Set between **1,000,000** - **9,999,000,000** or **00** (increments of 1M). Default is **50,000,000**. Set the desired **High Score Level** to which Level 3 may be achieved. Read Std. Adj. 28.

26 **DEFAULT HIGH SCORE #3:** Set between **1,000,000** - **9,999,000,000** or **00** (increments of 1M). Default is **45,000,000**. Set the desired **High Score Level** to which Level 4 may be achieved. Read Std. Adj. 28.

27 **DEFAULT HIGH SCORE #4:** Set between **1,000,000** - **9,999,000,000** or **00** (increments of 1M). Default is **40,000,000**. Set the desired **High Score Level** to which Level 5 may be achieved. Read Std. Adj. 28.

28 **HSTD RESET COUNT:** Set between **100** - **9,900** or **OFF** (increments of 100). Default is **2,000**. **HSTD (High Score To Date)**. Set the number of games between "automatic resets of High Score Levels" to "Default Scores" for **ONLY** Standard Adj. 24-27, **Default High Score #1-#4**.

29 **HIGH SCORE INITIALS:** Set to **3 INITIALS** or **10 LETTER**. Default is **3 INITIALS**. When set to **3 INITIALS**, the player is allowed only 3 initials to input. When set to **10 LETTER NAME**, the player is allowed to enter 10 initials to input.

30 **FREE PLAY:** Set to **YES** or **NO**. Default is **NO**. When set to **YES**, no coins are required for **Game Play**.

31 **CUSTOM MESSAGE:** Set to **ON**, **CHANGE** or **OFF**. Default is **ON**. When set to **CHANGE**, a new message can be set or the old one can be edited (select the "+" Mini-Icon to change settings until "CHANGE" appears in the display, then select the ">>" Mini-Icon to access.). This adjustment can be accessed in two (2) ways by either selecting the "S.P.I." Icon and advancing to this Adjustment, or can be directly accessed by selecting the "ABCD CUST MSG" Icon in the **ADJUSTMENTS MENU**.

View the Custom Message Shortcut summary (end of this chapter) for how to enter text or symbols.

Standard Adjustments 32-48 continued on the next page.





- 32 **FLASH LAMP POWER:** Set to **NORMAL**, **DIM** or **OFF**. Default is **NORMAL**. When set to **DIM**, the Flash Lamps impulse power is reduced by **25%** and when set to **OFF** the Flash Lamps will not flash.
- 33 **COIL PULSE POWER:** Set to **NORMAL**, **HARD** or **SOFT**. Default is **NORMAL**. When set to **HARD**, the coil pulse power is **increased** by **12.5%** of the normal pulse rate. When set to **SOFT** the coil pulse power is **decreased** by **12.5%** of the normal pulse rate. This adj. is provided to compensate for *Low Line* or *High Line voltage* conditions where the solenoids (coils) appear to *kicking too weak or too hard*. Adjust as required.
- 34 **KNOCKER VOLUME:** Set to **NORMAL**, **LOW** or **OFF**. Default is **NORMAL**. When set to **LOW**, the volume is decreased 50%. When set to **OFF**, no sound is heard when the "knocker" is sounded.
- 35 **GAME RESTART:** Set to **YES** or **NO**. Default is **YES**. When set to **YES**, a new game may be started during any ball after the first ball is completed (*if credits are available*). Pressing the **Start Button** during the first ball will add additional players. When set to **NO**, the game disables the **Start Button** after the first ball until the final ball is in play. *Review Sec. 2, Chp. 1, GAME OPERATIONS & FEATURES, for details.*
- 36 **BILL VALIDATOR:** Set to **YES** or **NO**. Default is **NO**. When set to **YES**, in *Game Attract Mode* the Display will show an "Insert Bill Animation." When set to **NO**, the Display will show an "Insert Coin Animation."
- 37 **BKGRND (BACKGROUND) MUSIC VOLUME:** Set between **01** - **15**. Default is **01**. After volume is set via Portals Service Buttons (*see Section 3, Chapter 1, PORTALS™ SERVICE MENU INTRODUCTION*) this adjustment can be utilized to adjust the background music (*1 all the way on, 15 all the way off*) while keeping the Special Sound FX the same level.
- 38 **FREEZE TIME (BALL SAVE):** Set to **OFF**, **0:01-0:15** or **AUTO**. Default is **OFF**. When set to **OFF** this feature is unavailable. Set between **0:01** through **0:15** (*single increments*) for the ball to be sent back into play if the time set is not met (*per ball*). Set to **AUTO** to automatically adjust the Freeze Timer based on the average ball time.
- 39 **////// UK ONLY //// Dip Switch Must Be Set //// UK POST SAVE ENABLED:** Set to **YES** or **NO**. Default is **NO**, (*UK Default is YES*). When set to **YES** this feature is available when lit. Set to **NO** to disable this feature. (*UK Games have Outlane/Center Post Save Devices which are accessed in differently; Non-UK Games cannot adjust this setting.*)
- 40 **TIMED PLUNGER:** Set to **OFF** or **0:15 - 1:00**. Default is **OFF**. When set to **0:15** to **1:00**, the plunger will "Autoplunge" the ball (*at the time set*) when the ball is at the beginning of play, awaiting the skill shot by the player.
- 41 **FLIPPER BALL LAUNCH:** Set to **DISABLED**, **LEFT FLIPPER**, **RIGHT FLIPPER**, **EITHER FLIPPER** or **BOTH FLIPPERS**. Default is **DISABLED**. This feature allows the player to operate the *Auto Ball Launch* with the **FLIPPER BUTTON(S)** depending on which setting is chosen.
- 42 **COINDOOR BALL SAVER:** Set to **YES** or **NO**. Default is **NO**. When set to **NO**, this feature is not available. When set to **YES**, this feature allows the **Coin Door** to be opened during game play; the ball will drain but the game will be placed "on hold". When the **Coin Door** is closed, the pinball will return to the Shooter Lane, and the game will resume.
- 43 **COMPETITION MODE:** Set to **YES** or **NO**. Default is **NO**. When set to **NO**, this feature is not available. If an **Install** of either **\$50** or **Free Play Comp.** was made (*changing default to YES*), and was changed back to **NO**, the **COMPETITION MODE** will be turned **OFF** (*see Sec. 3, Chp. 5, GO TO INSTALLS MENU, \$50 or Free Play Competition*). Set to **YES**, this feature is available (*required for Competition Modes*); this feature will equalize random game features and global score values during multi-player games.
- 44 **CONSOLATION BALL:** Set to **YES** or **NO**. Default is **YES**. When set to **YES**, the **EXTRA BALL** (*Playfield Light Insert, location varies*) will be lit on the last ball in play, if certain programming criteria is met.
- 45 **FAST BOOT:** Set to **YES** or **NO**. Default is **YES**. When set to **NO** or *if you hold the RIGHT Flipper Button during Power-Up*, this feature is not available and will display all normal Power-Up screens. When set to **YES**, the game will not display the normal informative Power-Up screens, specifically the CPU Version screen and the Location/Game ID screen. Regardless of the setting, normal Power-Up safety checks are still performed.
- 46 **Q24 OPTION:** Set to **COIN METER**, **TOKEN DISPENSER** or **KNOCKER**. Default is **COIN METER**. This Coil (Solenoid) Location is left "open" at the Factory to allow for these optional Mechanisms to be added to the game. If selecting **TOKEN DISPENSER**, Standard Adjustments 03, 06 & 12 should be changed to **TOKEN**. *Call Technical Support at 1-800-542-5377 if more information is required on this option.*
- 47 **TICKET DISP. INSTALLED:** Set to **YES** or **NO**. Default is **NO**. *This adjustment is required only for games which have an optional Deltronics (DL-1275-2 PCB Style, SPI Part Nr. 515-7275-00) Ticket Dispenser installed. Unique CPU Sound Bd. Dip Switch (Sw. 300) Setting required, changes the Default to YES.*
- 48 **ALLOW PLAYER COMP. MODE:** Set to **YES** or **NO**. Default is **YES**. **Competition Mode** unrandomizes feature events, and standardizes game play and rule sets (*varies from game to game*) for fair competitions. With adequate credit, to enter **Competition Mode**, hold the **Flipper Button** in while pressing the **Start Button**. **Watch the Dot Display for more details** (*rules and operation are subject to change*). General rules are covered in the Instruction Card. Other *Hints and/or Rules* can be made known on this game either visually (*the Dot Display or Flashing Light Inserts*) or can be audible.

Sec. 3: Adjustments





STANDARD ADJUSTMENT NAME: Definition

- 49 **TECH ALERT WARNING:** A Portals™ Function. Review Sec. 3, Chp. 2, **GO TO DIAGNOSTICS MENU**, Page 25, regarding **Technician Alerts** and its' functions. Set to **NEVER, POWERUP, COIN DOOR** or **POWERUP AND COIN DOOR**. Default is **NEVER**. When set to **NEVER**, the Tech Report Alert display will not appear upon Power-Up or opening the Coin Door, if the game detects any problems. When set to **POWERUP**, the display will appear only upon Power-Up (*if problems detected*). When set to **COIN DOOR**, the display will appear only when the Coin Door is opened (*if problems detected*). When set to **POWERUP AND COIN DOOR**, the display will appear upon Power-Up and if the Coin Door is opened (*if problems detected*).
- 50 **TEAM SCORES:** Set to **YES** or **NO**. Default is **NO**. Set to **YES**, then Team Play will be made available. **Team Play only works in a 4-Player Game**. The totals for Players 1 / 3 (Team 1) & Players 2 / 4 (Team 2) are then displayed individually **as well as** the combined score for **BOTH TEAMS** to enable **Team Play (Doubles)**. See Section 2, Chapter 1, **Game Operation & Features**, for non-adjustable Features.
- 51 **LOCATION ID:** Set between **00** to **9999**. Default is **00**. This adjustment allows the operator to assign a location identification number to the audit print-out sheet. (*Will not be affected by Factory Reset.*)
- 52 **GAME ID:** Set between **00** to **9999**. Default is **00**. This adjustment allows the operator to assign a game identification number to the audit print-out sheet. (*Will not be affected by Factory Reset.*)
- 53 **FLIPPER ADJ 1:** Set between **05** to **40**. Default is **10**. This adjustment sets the **minimum** fire time for a flipper coil in milliseconds.
- 54 **FLIPPER ADJ 2:** Set between **40** to **60**. Default is **50**. This adjustment sets the **maximum** fire time for a flipper coil in milliseconds.
- 55 **FLIPPER ADJ 3:** Set between **0** to **10**. Default is **3**. This adjustment sets the amount of time to fire the coil **after the EOS switch is seen** in milliseconds.

Standard Adjustments 53-55 Note: • Flippers will now fire when the button is pushed until the End-of-Stroke (EOS) Switch closure is seen. When EOS is seen, continue firing for the amount of time in Std. Adj. 55. When this time is expired, if the minimum time has not yet been met (Std. Adj. 53), then keep firing until it has. Otherwise switch to hold power. • If the flipper has been firing and it reaches the maximum (Std. Adj. 54), then switch to hold power. • If the flipper caves-in (EOS re-closes) while the button is still held, then re-fire the flipper at full power. Switch to hold power as soon as EOS is seen, no minimum times are enforced in this situation. • If the flipper caves in several times on the same single flipper button press, then stop re-firing at full power and just stay at hold. • If the flipper fails to open the EOS switch several times, then assume it isn't working and fall back to a "safe" fire time so as not to burn up the coil.

Sec. 3: Adjustments



Feature Adjustments (01-35)

To initiate, from the **ADJUSTMENTS MENU**, select the "LOTR" Icon with either the **Red "LEFT"** or **Green "RIGHT" Buttons** and press the **Black "ENTER" Button**. Select and **activate** either of the ">>" **Mini-Icons** to view the next or previous Adjustment in this group. Select and **activate** either of the "-" or "+" **Mini-Icons** to change the setting, if desired (*the Default Setting is noted in the definitions below*). The display will describe the **Adjustment Number, Adjustment Name** and the **Current Adjustment Setting**. The current Adjustment will remain in the display until the next Adjustment is view or when this Menu is exited. **Game Play, Rules, Settings and Explanation Subject to Change.**

Nr.	FEATURE ADJUSTMENT NAME: Definition
01	NUMBER RING COMBOS - (PER) LEVEL : Set between 5 - 15 . Default is 10 . <i>Note: This adjustment controls how many combos until the difficulty and points increase.</i>
02	TWO TOWERS MULTIBALL DIFFICULTY : Set to EXEASY, EASY, MODERATE, HARD or EXHARD . Default is MODERATE . <i>Note: This adjustment controls how long we need to survive.</i>
03	1ST HARD THE TWO TOWERS MULTIBALL : Set between 1 - 03 . Default is 1 . <i>Note: This adjustment determines which Multiball does the player need to light the locks for.</i>
04	THE TWO TOWERS LOCK DIFFICULTY : Set to EXEASY, EASY, MODERATE, HARD or EXHARD . Default is EXEASY . <i>Note: This adjustment controls how hard it is to light locks.</i> EXTRA EASY = No Locks Lit, 2 KEEP Letters, Lane Memory and Locks Stackable. EASY = No Locks Lit, 1 KEEP Letter, Lane Memory and Locks Stackable. MODERATE = No Locks Lit, 1 KEEP Letter, Lane Memory and Locks Unstackable. HARD = No Locks Lit, 1 KEEP Letter, No Lane Memory and Locks Unstackable. EXTRA HARD = No Locks Lit, 1 KEEP Letter, Lanes Toggle and Locks Unstackable.
05	PALANTIR DIFFICULTY : Set to EASY, MODERATE, HARD or EXHARD . Default is EASY . <i>Note: This adjustment controls how often the Palantir is lit.</i> EASY = At Ball Start. MODERATE = At Game Start. HARD = Never. EXTRA HARD = Off at Ball Start.
06	FELLOWSHIP (OF THE RING) MBALL DIFF. : Set to EASY, MODERATE, HARD or EXHARD . Default is EASY . <i>Note: This adjustment controls how many shots for each member.</i> EASY = 1 shot. MODERATE = 1 shot (only 1 lit at a time, randomly). HARD = 2 shots. EXTRA HARD = 2 shots per member in-a-row.

Feature Adjustments 7-25 continued on the next page.





FEATURE ADJUSTMENT NAME: Definition

- 07 **RING MULTIBALL DIFFICULTY** : Set to **EASY**, **MODERATE** or **HARD**. Default is **MODERATE**.
Note: This adjustment controls how hard it is to get cool awards.
- 08 **RING MULTIBALL EXTRA BALL MEMORY** : Set to **YES** or **NO**. Default is **NO**. When set to **YES**, this feature bonus (*Ring MB EB*) lit will be retained in memory from *ball-to-ball* for the same player. When set to **NO**, this feature will go out at the end of each ball.
- 09 **RING MULTIBALL SPECIAL MEMORY** : Set to **YES** or **NO**. Default is **NO**. When set to **YES**, this feature bonus (*Ring MB Special*) lit will be retained in memory from *ball-to-ball* for the same player. When set to **NO**, this feature will go out at the end of each ball.
- 10 **ELF GIFT EXTRA BALL MEMORY** : Set to **YES** or **NO**. Default is **YES**. When set to **YES**, this feature bonus (*Elf Gift EB*) lit will be retained in memory from *ball-to-ball* for the same player. When set to **NO**, this feature will go out at the end of each ball.
- 11 **ELF GIFT SPECIAL MEMORY** : Set to **YES** or **NO**. Default is **YES**. When set to **YES**, this feature bonus (*Elf Gift Special*) lit will be retained in memory from *ball-to-ball* for the same player. When set to **NO**, this feature will go out at the end of each ball.
- 12 **RING FRENZY EXTRA BALL DIFFICULTY** : Set to **EXEASY**, **EASY**, **MODERATE**, **HARD** or **EXHARD**. Default is **MODERATE**. Note: This adjustment determines the multiplier needed.
- 13 **RING FRENZY EXTRA BALL MEMORY** : Set to **YES** or **NO**. Default is **NO**. When set to **YES**, this feature bonus (*Ring Frenzy EB*) lit will be retained in memory from *ball-to-ball* for the same player. When set to **NO**, this feature will go out at the end of each ball.
- 14 **RING MODE DIFFICULTY** : Set to **EASY**, **MODERATE**, **HARD** or **EXHARD**. Default is **EASY**.
Note: This adjustment controls how often the Ring Mode is lit. **EASY** = Lit at Ball Start.
MODERATE = Lit at Game Start, with Memory. **HARD** = Off at Game Start, with Memory.
EXTRA HARD = Off at Ball Start.
- 15 **PATHS OF THE DEAD DIFFICULTY** : Set to **EXEASY**, **EASY**, **MODERATE**, **HARD** or **EXHARD**. Default is **MODERATE**. Note: This adjustment controls how Spots are lit. **EXTRA EASY** = 5 Spots Lit. **EASY** = 4 Spots Lit. **MODERATE** = 3 Spots Lit. **HARD** = 2 Spots Lit. **EXTRA HARD** = 1 Spot Lit.
- 16 **MYSTERY DIFFICULTY** : Set to **EASY**, **MODERATE**, **HARD** or **EXHARD**. Default is **HARD**.
Note: This adjustment controls how often the Mystery Mode is lit. **EASY** = Lit at Ball Start.
MODERATE = Lit at Game Start, with Memory. **HARD** = Off at Game Start, with Memory.
EXTRA HARD = Off at Ball Start.
- 17 **MYSTERY EXTRA BALL MEMORY** : Set to **YES** or **NO**. Default is **NO**. When set to **YES**, this feature bonus (*Mystery EB*) lit will be retained in memory from *ball-to-ball* for the same player. When set to **NO**, this feature will go out at the end of each ball.
- 18 **MYSTERY SPECIAL MEMORY** : Set to **YES** or **NO**. Default is **NO**. When set to **YES**, this feature bonus (*Mystery Special*) lit will be retained in memory from *ball-to-ball* for the same player. When set to **NO**, this feature will go out at the end of each ball.
- 19 **SPOT RING (TARGET) DIFFICULTY** : Set to **EASY**, **MODERATE**, **HARD** or **EXHARD**. Default is **EASY**.
Note: Controls when the spot ring target is lit. **EASY** = On at ball start. **MODERATE** = On at game start with memory. **HARD** = Off at game start with memory. **EXTRA HARD** = Off at ball start.
- 20 **ELF RING SPOTTING (DIFFICULTY)** : Set to **EXEASY**, **EASY**, **MODERATE** or **HARD**. Default is **MODERATE**. Note: Controls the number of cycles through the modes (i.e. a player has played all 6 modes) where shooting an unlit ring during normal play will spot an elf ring towards relighting the ring. **EXTRA EASY** = 3 cycles. **EASY** = 2 cycles. **MODERATE** = 1 cycle. **HARD** = Never.
- 21 **DWARF RING SPOTTING (DIFFICULTY)** : Set to **EXEASY**, **EASY**, **MODERATE** or **HARD**. Default is **EASY**. Note: Controls the number of mystery awards that can be collected where shooting an unlit mystery shot (Left VUK) will spot a dwarf ring towards relighting mystery. **EXTRA EASY** = 3 mysteries. **EASY** = 2 mysteries. **MODERATE** = 1 mystery. **HARD** = Never.
- 22 **HUMAN RING SPOTTING (DIFFICULTY)** : Set to **EXEASY**, **EASY**, **MODERATE** or **HARD**. Default is **MODERATE**. Note: Controls the number of Gollum Multiballs that can be collected where shooting an unlit Gollum Multiball shot (Right VUK) will spot a human ring towards lighting Gollum Multiball. **EXTRA EASY** = 3 Multiballs. **EASY** = 2 Multiballs. **MODERATE** = 1 Multiball. **HARD** = Never.
- 23 **FELLOWSHIP (OF THE RING) MULTIBALL DIFFICULTY** : Set to **EASY**, **MODERATE** or **HARD**. Default is **MODERATE**. Note: Controls which shots are lit to start Fellowship of the Ring Multiball. **EASY** = Left VUK / Orthanc / Top Saucer / Rt. VUK. **MODERATE** = Top Saucer / Rt. VUK. **HARD** = Top Saucer.
- 24 **RETURN OF THE KING MULTIBALL DIFFICULTY** : Set to **EASY**, **MODERATE** or **HARD**. Default is **MODERATE**. Note: Controls which shots are lit to start Return of the King Multiball. **EASY** = Lt VUK / Orthanc / Top Saucer / Rt VUK. **MODERATE** = Orthanc / Rt VUK. **HARD** = Orthanc.
- 25 **CONSOLATION MYSTERY** : Set to **YES** or **NO**. Default is **YES**. Note: Controls whether the game can light the mystery award for free on ball 3 if the player is having a poor game. If the game is set on competition mode, this adjustment will be treated as if set to No.

Sec. 3: Adjustments

Feature Adjustments 26-35 continued on the next page.

Go To
Adjustments Menu





Feature Adjustments Continued. Adjustments subject to change.

FEATURE ADJUSTMENT NAME: Definition

- 26 **ALLOW VOLUME EFFECTS:** Set to **YES** or **NO**. Default is **YES**. Set to **NO** to disable this feature. Set to **YES**, the volume will automatically adjust louder and softer, depending on which feature (or certain events) is being played and/or how well the player is performing (or awards received).
Note: If the game volume is set to 0, this adjustment will be treated as if set to NO.
- 27 **GAME START BALROG ROAR:** Set to **YES** or **NO**. Default is **YES**. Set to **NO** to disable this feature.
Note: This controls whether or not the Balrog roars as it closes at the start of a game.
- 28 **BARAD-DÛR DIFFICULTY:** Set to **EXEASY, EASY, MODERATE, HARD** or **EXHARD**. Default is **MODERATE**. *Note: This controls how many shots are required for the initial award from Barad-dûr.*
- 29 **BARAD-DÛR EXTRA BALL MEMORY:** Set to **YES** or **NO**. Default is **YES**. Set to **NO** to disable this feature. When set to **YES**, this feature bonus (*Barad-dûr EB*) *lit* will be retained in memory from *ball-to-ball* for the same player. When set to **NO**, this feature will go out at the end of each ball.
- 30 **SPOT FELLOWSHIP MEMBERS:** Set to **YES** or **NO**. Default is **YES**. Set to **NO** to disable this feature. When set to **YES**, after a player's 1st ball, 1 Fellowship member will be spotted at each ball start until the Fellowship of the Ring Multiball is played.
- 31 **GOLLUM'S CAVE DIFFICULTY:** Set to **EXEASY, EASY, MODERATE, HARD** or **EXHARD**. Default is **MODERATE**. *Note: This controls how many shots are required for the initial award from Gollum's Cave.*
- 32 **EARLY BARAD-DÛR CRASH:** Set to **YES** or **NO**. Default is **YES**. Set to **NO** to disable this feature.
Note: This controls whether Barad-dûr can "fall over" other than winning "Destroy the Ring."
- 33 **CAVE TROLL SEQUENCE:** Set to **ON** or **OFF**. Default is **OFF**. If set to **ON**, game adds the Cave Troll sequence to the start of The Fellowship of the Rings Multiball. If set to **OFF**, it goes straight to Balrog intro.
- 34 **CONSOLATION BALROG:** Set to **NONE, MYSTERY, CAVE** or **BOTH**. Default is **BOTH**. Set to **NONE** to disable this feature. *Note: This controls whether a player hasn't seen the Balrog, it allows it to come out on the following awards.* **MYSTERY** = can be randomly awarded, especially on Ball 3; **CAVE** = Will be the first award given from Cave Shots; **BOTH** = can be awarded by either Mystery or Cave, but at any rate there will only be one Consolation Balrog; **NONE** = no consolation Balrog will ever be awarded.
- 35 **DESTROY RING # BALLS:** Set between 1 - 2. Default is 1. When set to 1, when the first magnet shot is made, the ball will be held briefly, then let go. In order to win *Destroy the Ring*, you must make the ring shot clean through the ring (*the magnet will not turn on*) so that the ball registers the *Backpanel Trough Switch*. When set to 2, you must shoot the 4 shots, then shoot the ring. This ball is then held in the magnet indefinitely, and the goal is to knock out the first ball with a new ball launched into play.

Sec. 3: Adjustments

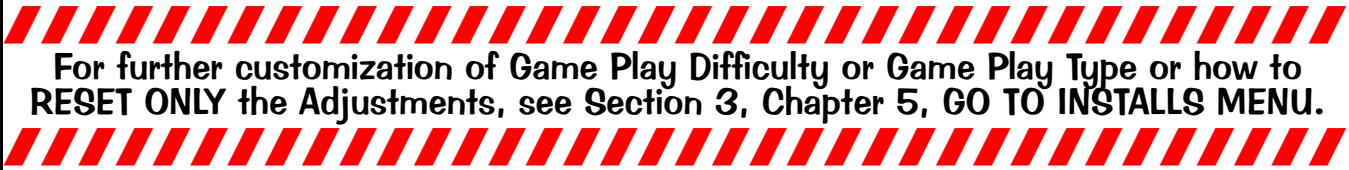

For further customization of Game Play Difficulty or Game Play Type or how to RESET ONLY the Adjustments, see Section 3, Chapter 5, GO TO INSTALLS MENU.



Custom Message

To go directly to **Standard Adjustment 31, Custom Message**, from the **ADJUSTMENT MENU**, select the "CUST MSG" *Icon* with either the **Red "LEFT"** or **Green "RIGHT"** **Buttons** and press the **Black "ENTER"** **Button**. At the top left corner of the Display, the letter **A** is indicated (*blinking*) in the first available position (*Thirty-Six (36) characters including spaces are available*). Vary the letter(s) by operating the Left and Right Flipper Buttons (or **"RED"** or **"GREEN"** **Buttons**). With the desired letter indicated, depress the **Start Button** to lock in the letter and advance to the next character. Repeat this procedure until the desired message is completed in the display. Select the "<" or ">" characters to back-space (*erase*) and/or to move forward in an already typed message. After completion, press the **"BLACK"** **Button**, **"REQUEST INSTALLED"** is indicated and then exits this sub-menu.



For further customization of Game Play Difficulty or Game Play Type or how to RESET ONLY the Adjustments, see Section 3, Chapter 5, GO TO INSTALLS MENU.



Go To Installs Menu

Overview

The Portals™ Service Menu System provides **15 Installs** to vary **Game Play (Feature Adjustments) Difficulty** or **Game Play Type** and **Install Factory** (restores all adjustments to Factory Defaults).



Important: The **Coin Door** must be **OPEN** allowing the **Memory Protect Switch** to be disabled, so any **Install** changes can be made.



For **detailed customization** or to check current **Adjustments Defaults** (either changed by YOU in the **Adjustments Menu** or by this **Installs Menu** or for **Factory Default Settings**), see **Section 3, Chapter 4, GO TO ADJUSTMENTS MENU**. **Important: Before preceding**, write down any **previously changed Adjustment Defaults**. After completing one or more of the **Installs** in this Chapter, go back to the **ADJUSTMENTS MENU** to see which **Standard and/or Feature Adjustments** have changed (*Feature Adjustments and/or settings are subject to change during production, and may differ than what is described in the tables at the end of this chapter*). If the settings are not to your liking, perform **one** of the following:

- 1.: **Manually** change the **Standard & Feature Adjustments** Settings (perform task in the **ADJUSTMENTS MENU**, see **Section 3, Chapter 4, GO TO ADJUSTMENTS MENU**).
- 2.: **Install Factory** (see opposite this page) on how to reset all of the **Standard & Feature Adjustments** back to the **Factory Default Settings**.

Multiple **Installs** can be set to vary game play; however, for **Installs** that have *one or more* Adjustments in common, the **last** "Install" selected & **activated**, will **supersede** any previously changed Adjustment(s) from any prior **Installs**. Any adjustments which you changed and are not affected by the Install will remain as set.

For example, if you want a **5-BALL Game** set to **EXTRA EASY**: Select and **activate** the "5BAL" **Icon** first (which will typically change any **Feature** Difficulty Adjustments to **HARD**), then select & **activate** the "X.EZ" **Icon** to **change back** the Difficulty Adjustments to **EXTRA EASY**. However, if the "X.EZ" **Icon** was selected & **activated** first, then the "5BAL" **Icon** was selected & **activated**, the game will be set to a **5-BALL Game** set to **HARD**.



EXPLANATION & USAGE OF COMMON LARGE ICONS USED IN THIS MENU:



These **non-selectable icons** appear in the **selected Menu** only when there are **MORE** icons to the **LEFT** or to the **RIGHT** available for selection.



Select and **activate** to return to the **PREVIOUS** Menu.



Select and **activate** to **QUIT**, exits & returns to the **Attract Mode**.



Select and **activate** to view **HELP** Screens of the **current Menu***.

WARNING:
Selection & activation of the "Install Factory" Icon, will change all Adjustments & Installs to the Factory Default!

* **Help Note:** An explanation of each **Icon** at that menu level will cycle continuously. To exit a display where no **Icons** are available for selection, pressing any button will exit the display.

Sec. 3: Go To Installs

GO TO INSTALLS MENU



After entering **Portals™**, the **MAIN MENU** now appears. Select the "INST" **Icon** in the **MAIN MENU** with either the **Red "LEFT"** or **Green "RIGHT"** Buttons (the **Flipper Buttons** operates in the same manner) and press the **Black "ENTER"** Button (the **Start Button** operates in the same manner). The **INSTALLS MENU** appears. Continue through this chapter for the explanation & usage of the **Icons** in the **INSTALLS MENU**.

View Pages **49 & 50** for an Overview of the **Standard & Feature Adjustment(s)** which have changed upon selection.



Install Extra Easy, Easy, Normal, Hard or Extra Hard

To initiate, from the **INSTALLS MENU**, select the "X.EZ," "EASY," "FACT," "HARD," or "X.HD" **Icons** with either the **Red "LEFT"** or **Green "RIGHT"** Buttons and press the **Black "ENTER"** Button. **Game Play Difficulty** is set to **EXTRA EASY**. "REQUEST INSTALLED" is indicated and returns to the **INSTALLS MENU** with the previously selected **Icon** flashing.



Go To
Installs Menu



Install Directors Cut

To initiate, from the **INSTALLS MENU**, select the "DCUT" *Icon* with either the **Red "LEFT"** or **Green "RIGHT"** Buttons and press the **Black "ENTER"** Button. **Game Play Type** is set to programmers choice. "REQUEST INSTALLED" is indicated and returns to the **INSTALLS MENU** with the "DCUT" *Icon* flashing.



Install 3-Ball or 5-Ball

To initiate, from the **INSTALLS MENU**, select the "3BAL" or "5BAL" *Icon* with either the **Red "LEFT"** or **Green "RIGHT"** Buttons and press the **Black "ENTER"** Button. **Game Play Type** is set to 3- or 5-BALL PLAY. "REQUEST INSTALLED" is indicated and returns to the **INSTALLS MENU** with the previously selected *Icon* flashing.



\$.50 Competition (a.k.a. IFPA)

To initiate, from the **INSTALLS MENU**, select the "PAY" *Icon* with either the **Red "LEFT"** or **Green "RIGHT"** Buttons and press the **Black "ENTER"** Button. **Game Play Type** is set to **TOURNAMENT PAY MODE**. "REQUEST INSTALLED" is indicated and returns to the **INSTALLS MENU** with the "PAY" *Icon* flashing.



Free Play Competition (a.k.a. EXPO or PAPA)

To initiate, from the **INSTALLS MENU**, select the "FREE" *Icon* with either the **Red "LEFT"** or **Green "RIGHT"** Buttons and press the **Black "ENTER"** Button. **Game Play Type** is set to **TOURNAMENT FREE MODE**. "REQUEST INSTALLED" is indicated and returns to the **INSTALLS MENU** with the "FREE" *Icon* flashing.

Sec. 3: Go To Installs



Install Home Play

To initiate, from the **INSTALLS MENU**, select the "HOME" *Icon* with either the **Red "LEFT"** or **Green "RIGHT"** Buttons and press the **Black "ENTER"** Button. **Game Play Type** is set to **NORMAL HOME PLAY**. "REQUEST INSTALLED" is indicated and returns to the **INSTALLS MENU** with the "HOME" *Icon* flashing.



Film Star Reset

To initiate, from the **INSTALLS MENU**, select the "STAR" *Icon* with either the **Red "LEFT"** or **Green "RIGHT"** Buttons and press the **Black "ENTER"** Button. **Game Play Type** is set to **EASY HOME PLAY**. "REQUEST INSTALLED" is indicated and returns to the **INSTALLS MENU** with the "STAR" *Icon* flashing.



Install Novelty

This setting is recommended where *local laws restrict certain game features*.

To initiate, from the **INSTALLS MENU**, select the "NOV" *Icon* with either the **Red "LEFT"** or **Green "RIGHT"** Buttons and press the **Black "ENTER"** Button. **Game Play Type** is set to **RESTRICTED PLAY**. "REQUEST INSTALLED" is indicated and returns to the **INSTALLS MENU** with the "NOV" *Icon* flashing.



Install Add-A-Ball

This setting is recommended where *local laws restrict certain game features*.

To initiate, from the **INSTALLS MENU**, select the "A.A.B" *Icon* with either the **Red "LEFT"** or **Green "RIGHT"** Buttons and press the **Black "ENTER"** Button. **Game Play Type** is set to **RESTRICTED PLAY**. "REQUEST INSTALLED" is indicated and returns to the **INSTALLS MENU** with the "A.A.B" *Icon* flashing.



Install Factory (ONLY affects all Adjustments/Installs)

To initiate, from the **INSTALLS MENU**, select the "FACT" *Icon* with either the **Red "LEFT"** or **Green "RIGHT"** Buttons and press the **Black "ENTER"** Button. **▲ All Standard & Feature Adjustments** which were changed in the **INSTALLS** or **ADJUSTMENTS MENU** are returned to the **Factory Defaults**.



Overview of Standard Adjustment Changes upon selection of an Install:

ONLY THE STANDARD ADJUSTMENTS LISTED ARE AFFECTED AS NOTED IN THE TABLES BELOW.



Nr.	STANDARD ADJUSTMENT NAME	INSTALL EXTRA EASY	INSTALL EASY	INSTALL NORMAL	INSTALL HARD	INSTALL EXTRA HARD	INSTALL DIRECTOR'S CUT	INSTALL 3-BALL	INSTALL 5-BALL
10	EXTRA BALL PERCENTAGE	30%	25%	20%	15%	10%		20%	10%
14	BALLS PER GAME							03	05
38	FREEZE TIME	0:12	0:10	0:08	OFF	OFF		0:08	AUTO

ONLY THE STANDARD ADJUSTMENTS LISTED ARE AFFECTED AS NOTED IN THE TABLES BELOW.



Nr.	STANDARD ADJUSTMENT NAME	\$.50 COMPETITION *	FREE PLAY COMP. *	INSTALL HOME PLAY	FILM STAR RESET	INSTALL NOVELTY	INSTALL ADD-A-BALL	INSTALL FACTORY
01	REPLAY TYPE					NONE		CAUTION! : Upon selection of Install Factory ("FACT" Icon), all Standard & Feature Adjustments which were changed in the INSTALLS or ADJUSTMENTS MENU are returned to the Factory Defaults (see the Adjustment Tables on Page 38 for details). * If Competition Mode was set, it is suggested to Install Factory to restore all Adjustments to the Factory Defaults . Then recustomize, if desired.
03	REPLAY AWARD						EX. BALL	
04	REPLAY LEVELS					NONE		
06	SPECIAL AWARD					POINTS	EX. BALL	
08	FREE GAME LIMIT					NO FREE..	NO FREE..	
09	EXTRA BALL LIMIT					NO EXTRA...	09	
10	EXTRA BALL PERCENTAGE			20%	20%			
11	GAME PRICING	USA 3						
13	MATCH PERCENTAGE			10%		OFF	OFF	
15	TILT WARNINGS	02	02					
18	GRAND CHAMPION AWARDS					00	00	
19	HIGH SCORE #1 AWARDS					00	00	
20	HIGH SCORE #2 AWARDS					00	00	
21	HIGH SCORE #3 AWARDS					00	00	
22	HIGH SCORE #4 AWARDS					00	00	
23	GRAND CHAMPION SCORE			25,000,000				
24	DEFAULT HIGH SCORE #1			20,000,000				
25	DEFAULT HIGH SCORE #2			15,000,000				
26	DEFAULT HIGH SCORE #3			10,000,000				
27	DEFAULT HIGH SCORE #4			5,000,000				
30	FREE PLAY	NO	YES	YES	YES			
35	GAME RESTART	NO	NO					
38	FREEZE TIME				0:10			
42	COINDOOR BALL SAVER **	(YES)**	(YES)**					
43	COMPETITION MODE ***	YES***	YES***					

** Adjustment 42 Default will not change; Installing \$.50 or Free Play Competition will override this Adjustment regardless of the setting.
 *** If Adjustment 43 is changed back to NO after this Install, the Competition Mode Install will be canceled (turned off).

Sec. 3: Go To Installs

Overview of Feature Adjustment Changes upon selection of an Install:

ONLY THE FEATURE ADJUSTMENTS LISTED ARE AFFECTED AS NOTED IN THE TABLES BELOW.



Nr.	FEATURE ADJUSTMENT NAME	INSTALL EXTRA EASY	INSTALL EASY	INSTALL NORMAL (FACTORY)	INSTALL HARD	INSTALL EXTRA HARD	INSTALL DIRECTOR'S CUT	INSTALL 3-BALL	INSTALL 5-BALL
01	NUM. RING COMBOS-LEVEL	15	12	10	8	5		10	10
02	TWO TOWERS MB DIFF	EX. EASY	EASY	MODERATE	HARD	EX. HARD		MODERATE	HARD
03	1ST HARD TTT MB	2	1	1	1	1		1	1
04	TTT LOCK DIFFICULTY	EX. EASY	EX. EASY	EASY	HARD	HARD		EASY	HARD
05	PALANTIR DIFFICULTY	EASY	EASY	EASY	MODERATE	HARD		EASY	MODERATE
06	FELLOWSHIP DIFFICULTY	EASY	EASY	EASY	MODERATE	HARD		EASY	EASY
07	RING MULTIBALL DIFF	EASY	EASY	MODERATE	MODERATE	HARD		MODERATE	MODERATE
08	RING MBALL E. BALL MEM	YES	YES	NO	NO	NO		NO	NO
09	RING MBALL SPECIAL MEM	YES	NO	NO	NO	NO		NO	NO
10	ELF GIFT E. BALL MEM	YES	YES	YES	YES	NO		YES	YES

Overview of Feature Adjustment Changes (this table) ... continued on the next page.

Go To
Installs Menu



Overview of Feature Adjustment Changes upon selection of an Install Continued:

ONLY THE FEATURE ADJUSTMENTS LISTED ARE AFFECTED AS NOTED IN THE TABLES BELOW.



Nr.	FEATURE ADJUSTMENT NAME	INSTALL EXTRA EASY	INSTALL EASY	INSTALL NORMAL (FACTORY)	INSTALL HARD	INSTALL EXTRA HARD	INSTALL DIRECTOR'S CUT	INSTALL 3-BALL	INSTALL 5-BALL
11	ELF GIFT SPECIAL MEM	YES	YES	YES	NO	NO		YES	NO
12	RING FRENZY E. BALL DIFF	EX. EASY	EASY	MODERATE	HARD	EX. HARD		MODERATE	HARD
13	RING FRENZY E. BALL MEM	YES	YES	NO	NO	NO		NO	NO
14	RING MODE DIFFICULTY	EASY	EASY	EASY	MODERATE	HARD		EASY	MODERATE
15	PATHS OF THE DEAD DIFF	EX. EASY	EASY	MODERATE	HARD	EX. HARD		MODERATE	HARD
16	MYSTERY DIFFICULTY	EASY	MODERATE	HARD	HARD	HARD		HARD	HARD
17	MYSTERY EB MEMORY	YES	YES	NO	NO	NO		NO	NO
18	MYSTERY SPECIAL MEM.	YES	NO	NO	NO	NO		NO	NO
19	RING TARGET DIFF.	EASY	EASY	EASY	HARD	EX. HARD		EASY	HARD
20	ELF RING DIFFICULTY	EX. EASY	EASY	MODERATE	HARD	HARD		MODERATE	MODERATE
21	DWARF RING DIFF	EX. EASY	EASY	EASY	MODERATE	HARD		EASY	MODERATE
22	HUMAN RING DIFF	EX. EASY	EASY	MODERATE	HARD	HARD		MODERATE	MODERATE
23	FOTR MB START DIFF	EASY	HARD	HARD	HARD	HARD		HARD	MODERATE
24	ROTK MB START DIFF	EASY	EASY	MODERATE	HARD	HARD		MODERATE	MODERATE
25	CONSOLATION MYSTERY	YES	YES	YES	NO	NO		YES	NO
27	GAME START BALROG ROAR						NO		
28	BARAD-DÛR DIFFICULTY	EX. EASY	EASY	MODERATE	HARD	EX. HARD		MODERATE	HARD
29	BARAD-DÛR E. B. MEMORY	YES	YES	YES	YES	NO		YES	YES
30	SPOT FELLOWSHIP MBRS.	YES	YES	YES	NO	NO		YES	NO
31	GOLLUM'S CAVE DIFF.	EX. EASY	EX. EASY	EASY	HARD	HARD		EASY	MODERATE
32	EARLY BARAD-DÛR CRASH						NO		
33	CAVE TROLL SEQUENCE						ON		
34	CONSOLATION BALROG						NONE		
35	DESTROY RING # BALLS						2		

ONLY THE FEATURE ADJUSTMENTS LISTED ARE AFFECTED AS NOTED IN THE TABLES BELOW.



Nr.	FEATURE ADJUSTMENT NAME	\$.50 COMPE-TITION *	FREE PLAY COMP. *	INSTALL HOME PLAY	FILM STAR RESET	INSTALL NOVELTY	INSTALL ADD-A-BALL	INSTALL FACTORY
01	NUM. RING COMBOS-LEVEL				15			
02	TWO TOWERS MB DIFF				EX. EASY			
03	1ST HARD TTT MB				2			
04	TTT LOCK DIFFICULTY				EX. EASY			
05	PALANTIR DIFFICULTY				EASY			
06	FELLOWSHIP DIFFICULTY				EASY			
07	RING MULTIBALL DIFF				EASY			
08	RING MBALL E. BALL MEM				YES			
09	RING MBALL SPECIAL MEM				YES			
10	ELF GIFT E. BALL MEM				YES			
11	ELF GIFT SPECIAL MEM				YES			
12	RING FRENZY E. BALL DIFF				EX. EASY			
13	RING FRENZY E. BALL MEM				YES			
14	RING MODE DIFFICULTY				EASY			
15	PATHS OF THE DEAD DIFF				EX. EASY			
16	MYSTERY DIFFICULTY				EASY			
17	MYSTERY EB MEMORY				YES			
18	MYSTERY SPECIAL MEM.				YES			
19	RING TARGET DIFF.				EASY			
20	ELF RING DIFFICULTY				EX. EASY			
21	DWARF RING DIFF				EX. EASY			
22	HUMAN RING DIFF				EX. EASY			
23	FOTR MB START DIFF				EASY			
24	ROTK MB START DIFF				EASY			
25	CONSOLATION MYSTERY				YES			
28	BARAD-DÛR DIFFICULTY				EASY			
29	BARAD-DÛR E. B. MEMORY				YES			
30	SPOT FELLOWSHIP MBRS.				YES			
31	GOLLUM'S CAVE DIFF.				EASY			

CAUTION! :
Upon selection of **Install Factory** ("FACT" Icon), all Standard & Feature Adjustments which were changed in the **INSTALLS** or **ADJUSTMENTS MENU** are returned to the **Factory Defaults** (see the Adjustment Tables on Page 38 for details).

Sec. 3: Go To Installs

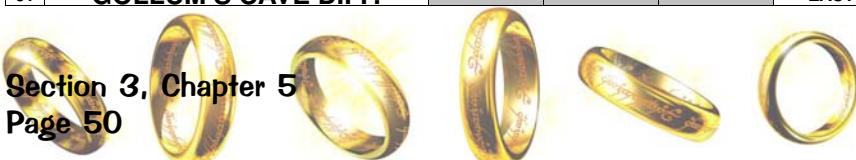

Go To Reset Menu

Overview

The Portals™ Service Menu System provides five (5) functions to reset **Coin & Game Audits, High Scores, Credits** or to reset **ALL AUDITS, ADJUSTMENTS & INSTALLS** back to the *Factory Default Settings*.



Important: The **Coin Door** must be **OPEN** allowing the **Memory Protect Switch** to be disabled, so any **Reset** changes can be made.



EXPLANATION & USAGE OF COMMON LARGE ICONS USED IN THIS MENU:



These **non-selectable** icons appear in the selected Menu only when there are **MORE** icons to the **LEFT** or to the **RIGHT** available for selection.



Select and activate to return to the **PREVIOUS** Menu.



Select and activate to **QUIT**, exits & returns to the **Attract Mode**.



Select and activate to view **HELP** Screens of the current Menu*.

⚠ WARNING: ⚠

As soon as any **Reset Icon** is selected & activated, the information associated with the **Reset Icon**, is lost!

* **Help Note:** An explanation of each icon at that menu level will cycle continuously. To exit a display where no icons are available for selection, pressing any button will exit the display.



GO TO RESET MENU

After entering **Portals™**, the **MAIN MENU** now appears. Select the **"RESET"** icon in the **MAIN MENU** with either the **Red "LEFT"** or **Green "RIGHT"** Buttons (the **Flipper Buttons** operates in the same manner) and press the **Black "ENTER"** Button (the **Start Button** operates in the same manner). The **RESET MENU** appears. Continue below for the explanation & usage of the *Icons* in the **RESET MENU**.



Reset Coin Audits

To initiate, from the **RESET MENU**, select the **"COIN"** icon with either the **Red** or **Green Buttons** and press the **Black Button**. ⚠ **ONLY** the **Coin Audits (05-13)** will be reset to zero (0), *Factory Default Settings*. **"REQUEST INSTALLED"** is indicated and returns to the **RESET MENU** with the **"COIN"** icon flashing.



Reset Game Audits

To initiate, from the **RESET MENU**, select the **"AUD"** icon with either the **Red** or **Green Buttons** and press the **Black Button**. ⚠ **ONLY** the **Game Audits (01-04) & Standard Audits (01-67)** will be reset to zero (0), *Factory Default Settings*. **Note:** **Coin Audits (05-13) & Software Meter Audit (14)** will not be reset. **"REQUEST INSTALLED"** is indicated and returns to the **RESET MENU** with the **"AUD"** icon flashing.



Reset High Scores

To initiate, from the **RESET MENU**, select the **"HSTD"** icon with either the **Red** or **Green Buttons** and press the **Black Button**. ⚠ **ONLY** the **High Scores** will be reset to the current values. **Note:** *If these five (5) adjustments were not personally changed by you, the Factory Default Settings will be used (see Section 3, Chapter 4, GO TO ADJUSTMENTS MENU, Standard Adjustments 18-22).* **"REQUEST INSTALLED"** is indicated and returns to the **RESET MENU** with the **"HSTD"** icon flashing.



Reset Credits

To initiate, from the **RESET MENU**, select the **"CRED"** icon with either the **Red** or **Green Buttons** and press the **Black Button**. ⚠ All **Credits** will be reset to zero (0), *Factory Default Settings*. **"REQUEST INSTALLED"** is indicated and returns to the **RESET MENU** with the **"CRED"** icon flashing.



Factory Reset

To initiate, from the **RESET MENU**, select the **"FACT"** icon with either the **Red** or **Green Buttons** and press the **Black Button**. ⚠ All **Audits (except for Audit 14, Software Meter)**, all **Adjustments** and **Installs** will be reset to the *Factory Default Settings*. **Note:** **To RESET ONLY the ADJUSTMENTS & INSTALLS (leaving all the Audits alone)**, see **Section 3, Chapter 5, GO TO INSTALLS MENU, Install Factory**. **"REQUEST INSTALLED"** is indicated and the **Service Menu** is exited, returning to the **Attract Mode**.



Example:

After entering **Portals™**, the **MAIN MENU** now appears. Use the Red "LEFT" or Green "RIGHT" Buttons to select the "RESET" *Icon* (**GO TO RESET MENU**).

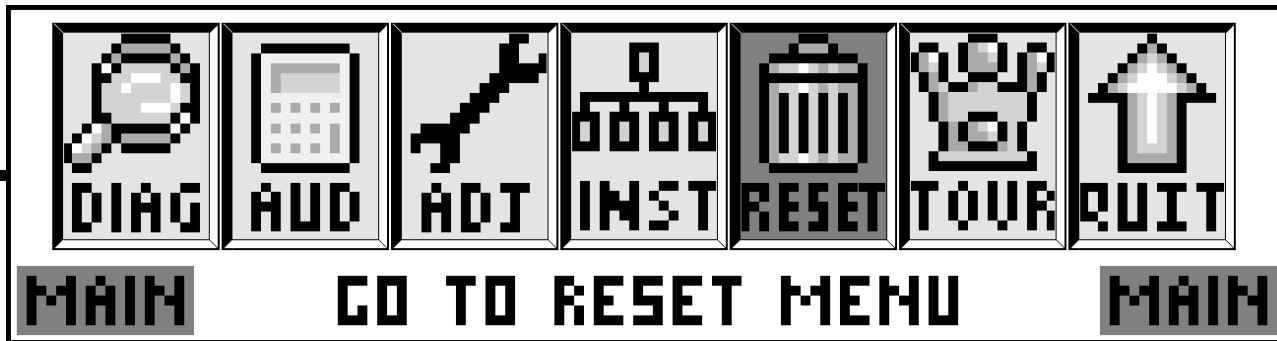

Press the **Black "ENTER" Button** to *activate* this **ICON**. The **RESET MENU** now appears with the "COIN" *Icon* (**RESET COIN AUDITS**) flashing:

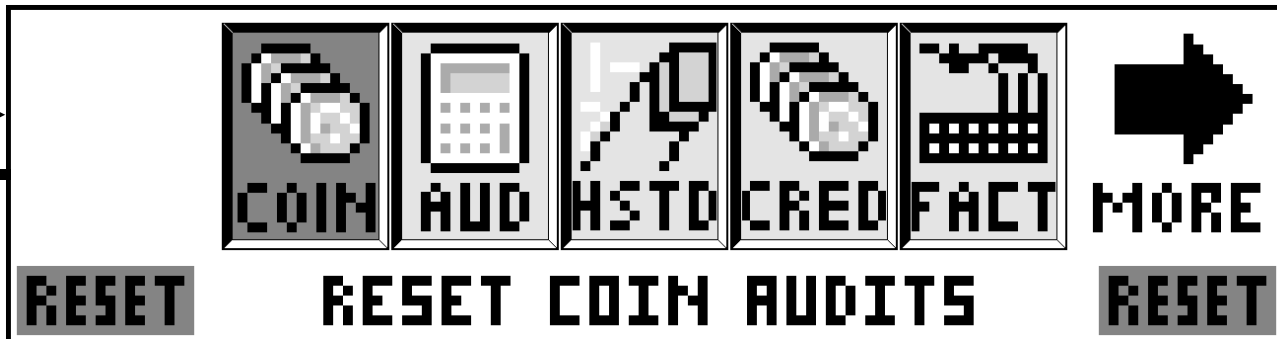

Sec. 3: Go To Reset

From the **RESET MENU**, select any of the *Icons* ("COIN", "AUD", "HSTD", "CRED") with either the **Red** or **Green Buttons** and press the **Black Button** to *activate* the **ICON** chosen. After the **ICON** is selected & *activated*, "**REQUEST INSTALLED**" is indicated and is returned to the **RESET MENU** with the previously selected *Icon* flashing.

Important:



AT THIS TIME, **DO NOT** PRESS THE **START BUTTON** OR **BLACK BUTTON** AFTER SELECTING ANY OF THE FIVE (5) **ICONS** UNLESS THIS IS WHAT IS DESIRED. **THE INFORMATION ASSOCIATED WITH THE RESET ICON WILL BE LOST!** PLEASE READ THE PREVIOUS PAGE FOR EXACTLY WHAT WILL HAPPEN IF ANY OF THESE FIVE (5) **ICONS** ARE **SELECTED & ACTIVATED**.



Before performing any **RESET**, write down your **last Audit Totals** (see **Section 3, Chapter 3, GO TO AUDITS MENU**) and any **personalized Adjustment changes** you may have made (see **Section 3, Chapter 4, GO TO ADJUSTMENTS MENU**).



If the "FACT" *Icon* is select and *activated*, "**REQUEST INSTALLED**" is indicated and the **Service Menu** is exited, returning to the **Attract Mode**. See the previous page for explanation & usage of the *Icons* in the **RESET MENU**.





Go To Tournament Menu

Overview

The **Portals™ Service Menu System** provides **6 Steps** necessary to **SET-UP, START, MONITOR** and **END** Pinball Tournaments on your *Tournament Pinball System Ready Pinball Game*. **OPTIONAL EQUIPMENT & HARDWARE (SOLD SEPARATELY) ARE REQUIRED FOR PROPER OPERATION AND USE OF THIS MENU.**

Game code may get upgraded during production; compare all Tournament Adjustments & Audits in the display with the manual and make any corrections to the Tournament Adjustments and/or Audits Tables (*next page*), as necessary. Tournament Adjustments & Audits are subject to change (*with or without notice*). To view Tournament Adjustments & Audits in the display, enter the **Portals™ Service Menu System**. When any change is made and then the next / previous item is selected (*or the Sub-Menu is exited*), the display will momentarily flash **REQUEST INSTALLED**. For details on **Earnings, Standard & Feature Audits**, see Section 3, Chapter 3, **GO TO AUDITS MENU**. For details on **Standard & Feature Adjustments**, see Section 3, Chapter 4, **GO TO ADJUSTMENTS MENU**.



Tournament Operation Note:

The use of the *Tournament Equipment* and/or running a Tournament is **OPTIONAL** and to be used solely in the discretion of the owner.

It is the sole responsibility of the operator to ensure that this product is used in conformity with all applicable laws. Stern Pinball, Inc.® disclaims any such responsibility.

Due to continuing product innovation, information in this chapter is subject to change without notice.



For more details on the equipment & hardware required, Installation and Set-up, read the **ToPS™ Tournament Pinball System Kit Installation Manual** (SPI Part Number: 780-6011-00) provided in the **Optional Tournament Kit** (SPI Part Number: 502-5011-00), not included with this *ToPS™ Ready Pinball Game*.

The equipment & hardware consists of: **BETAbrite™ Electronic 7 X 80 Multi-Color Dot Display** (*secured above the Backbox*), **Tournament Serial Interface (TSI) Board** (*secured in the Backbox*), **Tournament Button + Lamp** (*secured onto the Front Molding*) and all necessary wiring, hardware and documentation (*which also provides suggestions and Tips for ToPS™*).

To order, contact your local Distributor (*view Pages DR. 8 & 9 in the Find-It-In-Front: Dr. Pinball*). You can also call Technical Support or visit our website (*details on the back cover of this manual*).



Important: The **Coin Door** must be **OPEN** allowing the **Memory Protect Switch** to be disabled, so any **Tournament** changes can be made.



EXPLANATION & USAGE OF COMMON LARGE & MINI-ICONS USED IN VARIOUS MENUS & SUB-MENUS:



These **non-selectable** icons appear in the selected Menu only when there are MORE icons to the LEFT or to the RIGHT available for selection.



Select and activate to return to the **PREVIOUS** Menu.



Select and activate to **QUIT**, exits & returns to the **Attract Mode**.



Select and activate to view **HELP** Screens of the current Menu*.



Select and activate to:
Move **LEFT** or **RIGHT**, select previous / next or move backwards / forwards.
DECREMENT (-) or INCREMENT (+) displayed value or select previous / next.

* **Help Note:** An explanation of each Mini-Icon at that menu level will cycle continuously. To exit a display where no Mini-Icons are available for selection, pressing any button will exit the display.



GO TO TOURNAMENT MENU (OPTIONAL USE ONLY)

After entering **Portals™**, the **MAIN MENU** now appears. Select the "TOUR" *Icon* in the **MAIN MENU** with either the **Red "LEFT"** or **Green "RIGHT"** Buttons (the **Flipper Buttons** operates in the same manner) and press the **Black "ENTER"** Button (the **Start Button** operates in the same manner). The **TOURNAMENT MENU** appears. Continue through this chapter for the explanation & usage of the *Icons* in the **TOURNAMENT MENU**.



Tournament Adjustment & Audit Tables on the next page.

Go To
Tournament Menu

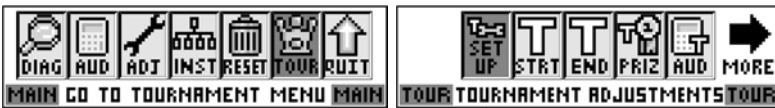

TOURNAMENT ADJUSTMENT TABLES

TOURNAMENT ADJUSTMENTS 01-13

Nr.	ADJUSTMENT NAME	USA DEFAULT	YOUR SETTING
01	CREDITS PER PLAY	02	
02	JACKPOT BASE	\$20.00	
03	JACKPOT INCREMENT	\$00.50	
04	JACKPOT MAX.	\$2,500.00	
05	CURRENT DATE/TIME	JANUARY...	
06	START DATE	JANUARY 1	
07	END DATE	FEBRUARY 1	

Nr.	ADJUSTMENT NAME	USA DEFAULT	YOUR SETTING
08	# OF PRIZES	03	
09	AWARD TYPE	CASH	
10	SHOW PLAYER'S CASH	YES	
11	TOURNAMENT TYPE	REGULAR	
12	BUMP N' WIN BASE	20,000,000	
13	BALLS PER TOURNAMENT	03	

Note: The above adjustments must be set just before selecting and activating the "STRT" Icon (START TOURNAMENT). See the following pages for explanation and more details.

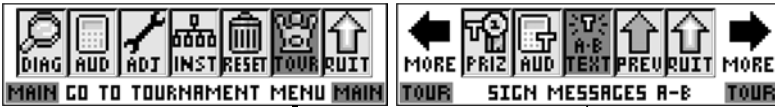

SIGN MESSAGES A-B (ADJUSTMENTS 14-15)

Nr.	ADJUSTMENT NAME	USA DEFAULT	YOUR SETTING
14	LOCATION MESSAGE	ON	

Nr.	ADJUSTMENT NAME	USA DEFAULT	YOUR SETTING
15	PRIZE MESSAGE	ON	

Sec. 3: Tournament ...



STARTING METER Reading :

STARTING METER Date (MM/DD/YR) :

AUDITOR'S NAME :

CURRENT VOLUME SETTING:

CURRENT METER Reading :

AUDIT Date (MM/DD/YR) :

CPU Version :

DISPLAY Version :

GAME LOCATION NAME :

See Adj. 06 & 07 above >>

TOURNAMENT START DATE :

TOURNAMENT END DATE :

TOURNAMENT AUDIT TABLE



TOURNAMENT AUDITS 01-12

Audit definitions follow in this Chapter.

01	TOTAL PLAYS
02	TOURNAMENT PLAYS
03	TOTAL GAME EARNINGS
04	TOTAL TOUR. EARNINGS
05	JACKPOT

06	NET EARNINGS
07	ACCUM. TOTAL PLAYS
08	ACCUM. TOUR. PLAYS
09	ACCUM. EARNINGS
10	ACCUM. TOUR EARNINGS

11	ACCUM. JACKPOT
12	# TOURNAMENTS





Tournament Adjustments (01-13)



To initiate, from the **TOURNAMENT MENU**, select the "SET UP" *Icon* with either the **Red "LEFT"** or **Green "RIGHT" Buttons** and press the **Black "ENTER" Button**. Select and *activate* either of the ">>" *Mini-Icons* to view the next or previous Tournament Adjustment in this group. Select and *activate* either of the "-" or "+" *Mini-Icons* to change the setting, if desired (*the Default Setting is noted in the definitions below*). The display will describe the **Tournament Adjustment Number**, **Tournament Adjustment Name** and the **Current Tournament Adjustment Setting**. The current Tournament Adjustment will remain in the display until the next Tournament Adjustment is viewed or when this Menu is exited.

IMPORTANT FOR TOURNAMENT USERS: *Select the settings carefully. For Tips for ToPS™ (different Tournament Sample Set-Ups, etc.), view the ToPS™ Tournament Pinball System Kit Installation Manual (SPI Part Number: 780-6011-00) provided in the Optional Tournament Kit (SPI Part Number: 502-5011-00). Before allowing players to begin after you've started a Tournament, double-check the Normal Mono-Color Dot Display and Top Multi-Color Dot (Beta Brite®) Display to ensure everything you want is displayed correctly. Once a Tournament is started, no adjustments can be made until you end the Tournament (by selecting the "END" Icon). Allowing players to qualify, then ending a Tournament prematurely to make corrections will affect the outcome of the Tournament. View the ToPS™ Manual for more details.*

WARNING: Changes made in any Adjustments will be lost after a FACTORY RESET or removal of the CPU/Sound Board Batteries.

Nr.	TOURNAMENT ADJUSTMENT NAME: Definition
01	CREDITS PER PLAY: Set between 01 - 10 . Default is 02 . Set the maximum number of <i>Credits</i> that may be accumulated per game.
02	JACKPOT BASE: Set between \$00.00 - \$999,999.00 (<i>increments of \$1</i>). Default is \$20.00 . Set the initial <i>Prize Pool Amount</i> to be offered for the Tournament. Note: <i>The displays will present the words "PRIZE POOL" in lieu of the word "JACKPOT".</i>
03	JACKPOT INCREMENT: Set between \$00.00 - \$999,999.99 (<i>increments of 1¢</i>). Default is \$00.50 . Set the <i>Prize Pool Increment</i> which will increase the <i>Prize Pool Amount</i> with each Tournament Game played.
04	JACKPOT MAX.: Set between \$00.00 - \$999,999.00 (<i>increments of \$1</i>). Default is \$2,500.00 . Set the maximum cap to be placed on the <i>Prize Pool</i> during a Tournament. Note: <i>The displays will present the words "PRIZE POOL" in lieu of "JACKPOT".</i>
05	CURRENT DATE/TIME: Set the current date and time. After setting the Start and End Dates in Tournament Adjustments 6 & 7, the Tournament will then start automatically*. *Requires the TIMEKEEPER™ IC (included in the kit) installed in Location U212 on the CPU/Sound Board.
06	START DATE: Set between JANUARY through DECEMBER . Default is JANUARY . After the month desired is set, a valid day must be set. To Start a Tournament , go back to the TOURNAMENT MENU and select the "STRT" <i>Icon</i> (<i>see the next page</i>).
07	END DATE: Set between JANUARY through DECEMBER . Default is FEBRUARY . After the month desired is set, a valid day must be set. To End a Tournament , go back to the TOURNAMENT MENU and select the "END" <i>Icon</i> (<i>see the next page</i>).
08	# OF PRIZES: Set between 01 - 05 . Default is 03 . Set the maximum number of <i>Prize Positions</i> to be awarded during a Tournament. Selections (<i>cannot be changed</i>) are as follows: Set to 01 , the Tournament Winner is awarded 100% of the <i>Prize Pool</i> . Set to 02 , the 1st & 2nd place winners are awarded 70% / 30% , respectively. Set to 03 , the 1st, 2nd & 3rd place winners are awarded 50% / 30% / 20% , respectively. Set to 04 , the 1st, 2nd, 3rd & 4th place winners are awarded 50% / 25% / 15% / 10% , respectively. Set to 05 , the 1st, 2nd, 3rd, 4th & 5th place winners are awarded 50% / 20% / 15% / 10% / 5% , respectively.
09	AWARD TYPE: Set to CASH, POINTS, TICKET, NONE or PRIZE . Default is CASH . <i>This adjustment determines how the Prize Pool is to be represented in the Attract Mode on both the Normal and top Beta-Brite® Displays.</i>
09	Select CASH for the displays to represent the <i>Prize Pool amount (based on Jackpot Base and Max.)</i> in \$Dollars . Select POINTS for the displays to represent the <i>Prize Pool amount</i> in Points . Select TICKET for the display to represent the <i>Prize Pool amount</i> in Tickets . Select NONE NOT TO represent the <i>Prize Pool amount (if prize(s) to be awarded are not Cash, Points or Tickets)</i> . Select PRIZE , if applicable.
10	SHOW PLAYER'S CASH: Set to YES or NO . Default is YES . When set to YES , both the Beta-Brite® Multi-Color and the Normal Mono-Color Dot Displays exhibit the <i>Cash amount</i> in the Attract Mode .
11	TOURNAMENT TYPE: Set to REGULAR or BUMP N' WIN . Default is REGULAR .
12	BUMP N' WIN BASE: Set between 5,000,000 - 50,000,000 (<i>increments of 1M</i>). Default is 20,000,000 . Set the desired Bump N' Win Tournament base score. Tournament Adj. 11 must be set to BUMP N' WIN.
13	BALLS PER TOURNAMENT: Set between 02 - 09 . Default is 03 . Set the max. number of balls per game.

Sec. 3: Tournament ...

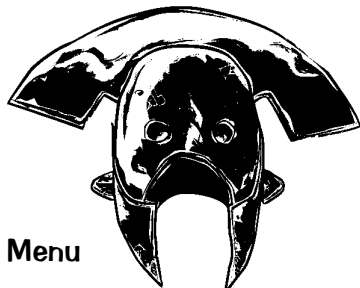

Go To
Tournament Menu



Start Tournament (select only after Set-Up is completed)

To initiate, from the **TOURNAMENT MENU**, select the "STRT" *Icon* with either the **Red "LEFT"** or **Green "RIGHT"** **Buttons** and press the **Black "ENTER"** **Button**. The "START TOURNAMENT?" **MENU** appears with the "NO" *Mini-Icon* flashing.

If **Set-Up (Tournament Adjustments)** was not completed **OR** the **Tournament Audits were not recorded from the prior Tournament**, exit this Menu by activating the "NO" *Mini-Icon*. If **Set-Up** was completed and the **Tournament Audits** were recorded, select and activate the "YES" *Mini-Icon*.

The Pinball Game is set to **Tournament Ready Mode**

(the **Flashing Tournament Button** must be depressed for a *Tournament Game* after the proper credit is inserted). "REQUEST INSTALLED" is indicated and returns to the **TOURNAMENT MENU** with the "STRT" *Icon* flashing. **Note:** If the "STRT" *Icon* appears to be non-functioning, it is because a *Tournament* is in progress. The *Tournament* must first be stopped (select and activate the "END" *Icon* in the **TOURNAMENT MENU**).



Stop Tournament (select only after a Tournament is started)

To initiate, from the **TOURNAMENT MENU**, select the "END" *Icon* with either the **Red "LEFT"** or **Green "RIGHT"** **Buttons** and press the **Black "ENTER"** **Button**. The "END TOURNAMENT?" **MENU** appears with the "NO" *Mini-Icon* flashing. If the

Tournament was not completed, exit this Menu by activating the "NO" *Mini-Icon*. If the **Tournament** was completed (the *End Date* set has passed), select and activate the "YES" *Mini-Icon*. The Pinball Game is taken out of **Tournament Ready Mode** (to readjust any *Tournament Adjustments*, the *Tournament* must be "stopped"). "REQUEST INSTALLED" is indicated and returns to the **TOURNAMENT MENU** with the "END" *Icon* flashing.

Record your Tournament Audits at this time as they will be reset (except for the "Accumulative Audits") if another Tournament is started!



Sec. 3: Tournament ...



Tournament Prizes

To initiate, from the **TOURNAMENT MENU**, select the "PRIZ" *Icon* with either the **Red "LEFT"** or **Green "RIGHT"** **Buttons** and press the **Black "ENTER"** **Button**. Select and *activate* either of the ">>" *Mini-Icons* to view the next or previous *Leader* in this group. The display will describe the **Leader Placement (1st, 2nd, 3rd, 4th & 5th)**, **Leader Name**, **4-Digit Pin-Code**, and **Prize Pool** portion for the *Current* and *Previous Tournaments*. The current *Leader (and related information)* will remain in the display until the next *Leader* is chosen or when the *Sub-Menu* is exited.



Tournament Audits (01-12)

To initiate, from the **TOURNAMENT MENU**, select the "AUD" *Icon* with either the **Red "LEFT"** or **Green "RIGHT"** **Buttons** and press the **Black "ENTER"** **Button**. Select and *activate* either of the ">>" *Mini-Icons* to view the next or previous *Tournament Audit* in this group. The display will describe the **Tournament Audit Number**, **Tournament Audit Name** and the **Current Tournament Audit Total** (Value). The current *Tournament Audit* will remain in the display until the next *Tournament Audit* is viewed or when this *Menu* is exited.

IMPORTANT FOR TOURNAMENT USERS: >>>> **A L L** of the *Tournament Audits 01-12* are **RESET O N L Y** if a **Factory Reset** is done (see *Section 3, Chapter 6, GO TO RESET MENU*). >>>> **Tournament Audits 01-06** are **RESET ONLY** if a **new Tournament** is started. >>>> **Tournament Audits 07-12** are **NOT RESET***, they're *accumulative (totals accumulate since the first Tournament was played)*. *if no **Factory Reset** is done.

Nr.	TOURNAMENT AUDIT NAME: Definition
01	TOTAL PLAYS: Provides the total number of <i>Regular</i> and <i>Tournament Games</i> played while a <i>Tournament</i> is active (in progress). This total is derived by adding Tournament Audit 02, TOURNAMENT PLAYS , with Regular Plays .
02	TOURNAMENT PLAYS: Provides the total number of <i>Tournament Games</i> played while a <i>Tournament</i> is active (in progress).
03	TOTAL GAME EARNINGS: Provides the total <i>Gross Earnings accepted</i> , while a <i>Tournament</i> is active (in progress).
04	TOTAL TOUR. EARNINGS: Provides the total <i>Tournament Earnings (Audit 03 less Regular Game Earnings)</i> while a <i>Tournament</i> is active (in progress).
05	JACKPOT (PRIZE POOL TOTAL): Provides the total <i>Prize Pool (Jackpot) Amount</i> to be paid out while a <i>Tournament</i> is active (in progress).
06	NET EARNINGS: Provides the total <i>Net Earnings (Gross Earnings less Prize Pool)</i> while a <i>Tournament</i> is active (in progress).

Tournament Audits 07-12 continued on the next page.





The following Tournament Audits **WILL NOT BE RESET** if a new Tournament is started. **ALL AUDITS** can be reset if a Factory Reset is done!

- 07 **ACCUM. TOTAL PLAYS:** Provides the accumulative total amount of *Regular & Tournament Games* played since the first Tournament was played.
- 08 **ACCUM. TOUR. PLAYS:** Provides the accumulative total amount of *Tournament Games* played since the first Tournament was played.
- 09 **ACCUM. EARNINGS:** Provides the total Gross Earnings *accepted*, since the first Tournament was played.
- 10 **ACCUM. TOUR EARNINGS:** Provides the accumulative total Tournament Game Earnings since the first Tournament was played.
- 11 **ACCUM. JACKPOT:** Provides the accumulative total of Prize Pool (*Jackpot*) Amounts paid out since the first Tournament was played.
- 12 **# TOURNAMENTS:** Provides the number of Tournaments (*not individual Tournament Games*) since the first Tournament was played.



Sign Messages A-B (Tournie Adj. 14-15)

To initiate, from the **TOURNAMENT MENU**, select the "A-B TEXT" *Icon* with either the **Red "LEFT"** or **Green "RIGHT"** Buttons and press the **Black "ENTER" Button**. Select and *activate* either of the ">>" *Mini-Icons* to view the next or previous Tournament Adjustment in this group. Select and *activate* either of the "-" or "+" *Mini-Icons* to change the setting, if desired (*the Default Setting is noted in the definitions below*). The display will describe the **Tournament Adjustment Number**, **Tournament Adjustment Name** and the **Current Tournament Adjustment Setting**. The current Tournament Adjustment will remain in the display until the next Tournament Adjustment is viewed or when this Menu is exited.

Nr.	TOURNAMENT ADJUSTMENT NAME: Definition
14	<p>LOCATION MESSAGE: Set to ON, CHANGE or OFF. Default is ON. When set to CHANGE, a new message can be set or the old one can be edited (<i>select the "+" Mini-Icon to change settings until "CHANGE" appears in the display, then select the ">>" Mini-Icon to access.</i>). At the top left corner of the Display, the letter A is indicated (<i>blinking</i>) in the first available position. Vary the letter(s) by operating the Left and Right Flipper Buttons (<i>or "RED" or "GREEN" Buttons</i>). With the desired letter indicated, depress the Start Button to lock in the letter and advance to the next character. Repeat this procedure until the desired message is completed in the display. Select the "<" or ">" characters to back-space (<i>erase</i>) and/or to move forward in an already typed message. After completion, press the "BLACK" Button, "REQUEST INSTALLED" is indicated and then exits this sub-menu.</p>
15	<p>PRIZE MESSAGE: Set to ON, CHANGE or OFF. Default is ON. <i>Procedure identical to Tournament Adjustment 14, Location Message.</i></p>

The **DEFAULT LOCATION MESSAGE** is:

STERN PINBALL PROUDLY PRESENTS...

The **DEFAULT PRIZE MESSAGE** is:

YOU CAN BE THE NEXT BIG WINNER!



IMPORTANT FOR TOURNAMENT USERS: 2 additional messages can be added by using the **Beta Brite® Remote**. More details in the **ToPS™ Tournament Pinball System Kit Installation Manual** (SPI Part Number: 780-6011-00) provided in the **Optional Tournament Kit** (SPI Part Number: 502-5011-00).

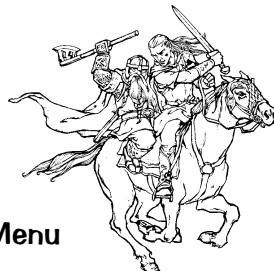

Go To
Tournament Menu

HOW TO ENTER A MESSAGE:

1. POINT THIS REMOTE CONTROL (REAR) AT THE DISPLAY.
2. PRESS THE [PROGRAM] KEY. THE WORDS "PROG TEXT" WILL APPEAR ON THE DISPLAY.
3. ENTER THE MESSAGE YOU WANT TO BE DISPLAYED. (USE THE [L] AND [R] KEYS FOR PUNCTUATION).
4. PRESS THE [RUN] KEY TWICE.

SEE YOUR PROGRAMMING MANUAL FOR ADDITIONAL INSTRUCTIONS AND DISPLAY FEATURES.

BETA brite

Sec. 4: Parts Id. ...



How Lee Productions, Inc. All Rights Reserved.

LORD OF THE RINGS

THE RINGS OF POWER
THE TWO TOWERS
THE RETURN OF THE KING

Light All Rings For Ring Henry

SECRET AGAIN

© 2003 How Lee Productions, Inc. All Rights Reserved. Pinball Machine No. 100-000-000

50¢ = 1  x1

SUPER VALUE

\$2.00 = 1  x5

© 2003 How Lee Productions, Inc. All Rights Reserved. Pinball Machine No. 100-000-000



Parts Identification & Location (The Pink Pages)

Overview



This section provides the Part N^os and locations of all the components in this Pinball Machine. The parts are arranged in 3 groups: **BACKBOX**, **CABINET** and **PLAYFIELD**. Generic parts which may change as production continues (quantity and/or size) are listed together. Quantities greater than 0 indicates that the part is used in this game. Since quantity changes *may occur*, an item indicating no quantity *may be used*. Compare the item which needs to be replaced with the drawings provided (*the Posts, Sockets, Bulbs & Rubber Rings are drawn actual size*). Major Assemblies & Ramps are detailed in the **Blue Pages**, Pages 75-98.

Important: Read all "Take Note:" items.

Pinball Location Maint. Kit Available
502-6002-80
This kit consists of 8 oz. Novus Wax #2 Fine (Red) (675-0003-01), cloth and all Rubber Rings & Bulbs used in this Pinball Machine.

Ask your distributor about the Deluxe Pinball Location Maintenance Kit which includes Flipper Rebuild Kits!



Parts Identification & Location

**Section 4,
Table of Contents**

Chapter 1: The Pink Pages

Overview 59

BACKBOX:

Lord of the Rings

Backbox Assy. 60

Speaker Panel Assy. for the Backbox & Assoc. Parts: ... 61

CABINET:

Cabinet -General Parts & Switches 62-63

PLAYFIELD:

Playfield - General Parts, Metal Rails/Ball Guides & Switches (Above) 64-65

Playfield - General Parts & Switches (Below) 66

Playfield Plastics (Screened & Clear) & Decals 67

Playfield - Rubber Parts Black 68

Playfield - Metal Posts (Screws) & Nuts 69

Playfield - Hex Spacers 70

Playfield - Posts & Spacers 71

Playfield - Small Bayonet Type Bulbs & Sockets 72

Playfield - Large Bayonet Type Bulb & Sockets 73

Playfield - Wedge Base Bulbs & Sockets 74

Chapter 2: The Blue Pages

Overview 75

Drawings for Major Assemblies & Ramps 76-98

Sec. .4: Parts Id. ...

Not sold as an assembly, order the individual part(s) actually required.

THE LORD OF THE RINGS Backbox Assembly, 505-6002-80-80 (Items 1-27)

‡ Item 20, Button Hole Plug (Black) is the optional ToPS™ Access Hole; if removing for the Optional ToPS™ Kit, save with the game.

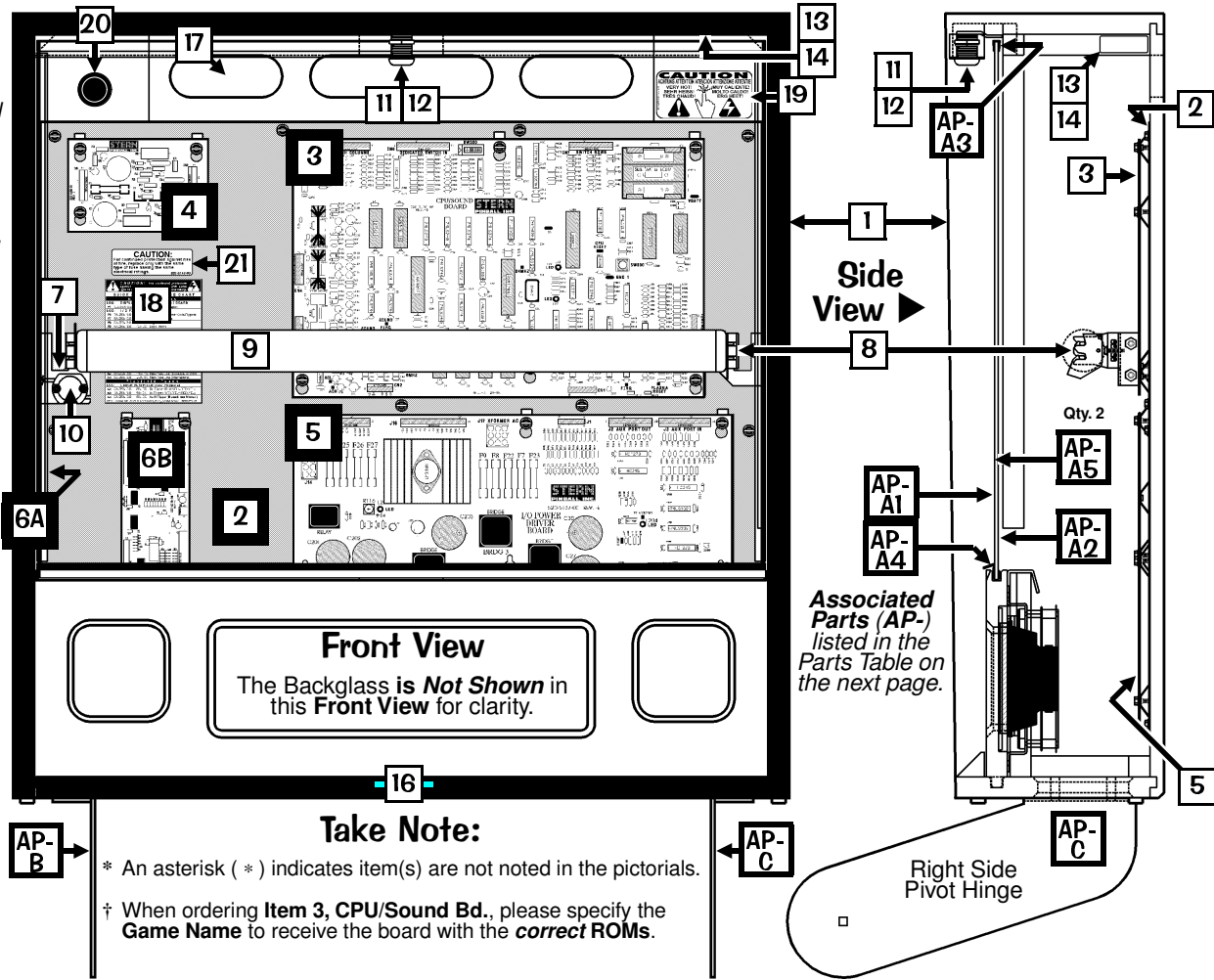

Sec. 4: Parts Id. ...

Nº	BACKBOX PART NAME	QTY.	SPI PART Nº	Nº	BACKBOX PART NAME	QTY.	SPI PART Nº
1	Backbox LOTR Screened No Parts	1	525-5631-18-80	13	Ballast Mounting Plate	1	535-8657-00
<i>Item 1 Note: Black & Gold T-Molding is installed and cannot be ordered separately.</i>							
2	PCB Metal Mounting Plate	1	535-5809-14	14	Ballast CU45Z-W 1/2" Core 120v 60 Hz 13W	1	010-5015-00
<i>Item 2 is secured to Item 1 by: #8 X 1/2" HWH AB (Zinc) (Qty. 13) (234-5101-00) and #10 Washer 7/32" I.D. X .5" O.D. X 1/16" Thick (Qty. 4) (242-5003-00)</i>							
3 †	CPU/Snd. Bd. w/ATMEL Sound Processor	1	520-5300-00	<i>Ballast, EU / UK Only 5/8" Core 50/60 Hz 010-5015-01</i>			
4	Display Power Supply Board	1	520-5138-00	<i>Items 13 & 14 are secured to Item 1 by: #6 X 5/8" HWH AB (Zinc) (Qty. 2) (234-5102-04)</i>			
5	I/O Power Driver Board	1	520-5137-01	15*	#1 Roto Lock Male (on Cabinet)	1	355-5006-01
<i>Items 3, 4 & 5 are secured to Item 2 by: #8-32 X 3/8" HWH MS (Qty. 19) (237-5903-00)</i>							
6A	3X Trans. Drvr. Bd. (UK/Special Apps.Only)	520-5068-01		16	#1 Roto Lock Female (R2-0002-02)	1	355-5006-02
6B	Tournament Serial Interface (TSI) Bd. ToPS™	520-5220-00		<i>Item 16 is secured by: #10-24 X 1-3/4" CBSN (Qty. 2) (231-5022-00), #10-24 Keps Nut (Qty. 2) (240-5207-00) and #10 Washer 7/32" ID X .5" OD X 1/16" (Qty. 2) (242-5003-00)</i>			
<i>Item 6A is required for UK Games to support Auxiliary assemblies listed under the Coil Matrix of Q1-Q32; also used for Special Applications such as Ticket / Coin Dispensers used in conjunction with Item 6B ToPS™ Tournament Serial Board.</i>							
7	Fluorescent Light Bracket Assy. Left	1	515-6545-00	17	Back Vent Grill 2-1/2" X 18"	1	545-5072-02
<i>For Individual Items use : Fluorescent Light Bracket Left (535-7739-00), Lamp Holder** (Self-Locking) (077-5214-00) and Starter Base (with Leads)*** (077-5213-00).</i>							
8	Fluorescent Light Bracket Assy. Right	1	515-6545-01	18	Fuse Description Decal (Generic)	1	820-6152-01
<i>For Individual Items use : Fluorescent Light Bracket Right (535-7739-01), Lamp Holder** (Self-Locking) (077-5214-00) and Starter Base (with Leads)*** (077-5213-00).</i>							
<i>** secured by: #6-32 X 5/8" PPH MS (Sems) Zinc (Qty. 1) (232-5203-00)</i>							
<i>*** secured by: #4-40 X 1/2" PPH MS (Sems) Zinc (Qty. 2) (237-5813-00)</i>							
<i>Items 7 & 8 are secured to Item 1 by: #10-24 X 1-1/4" Carriage Bolt Sq. Neck (Qty. 2/per) (231-5012-00), #10-24 Keps Nut (Qty. 2/per) (240-5207-00) and 3/4" X 3" Reinforced Strapping Tape (Qty. 1, Sold in 12" Lengths only) (626-5040-00)</i>							
9	Fluorescent Tube 24" (F18T8CW)	1	165-5061-00	19	"CAUTION - VERY HOT" Decal	1	820-6266-00
10	Starter - Fluorescent (FS2 Light)	1	165-5011-01	20 ‡	Button Hole Plug (Blk) (Happ #52-6214-00)	1	500-6566-00
11	Lock Mounting Plate	1	535-8128-01	21	Fuse Label (UL)	1	820-6143-00
12	Lock 5/8" Barrel, 3/4"ø, 1.5" Flat Cam	1	355-5055-00	22*	Backbox Date Label	1	820-5091-00
<i>Items 11-12 are secured by: #8 X 5/8" TP Torx T20 (Qty. 4) (237-5947-00)</i>							
				23*	Ribbon Cable, 20-Pin (4")	1	036-5000-04
<i>Item 23 (20-Pin) connects the CPU/Sound Board to the I/O Power Driver Board.</i>							
				24*	Ribbon Cable, 26-Pin (40")	1	036-5001-40
<i>Item 24 (26-Pin) connects the CPU/Sound Board to the Display Controller Board.</i>							
				25*	1/4" Clamp (Double)	2	040-5000-23
				26*	1/2", 3/4" & 1" Clamp (Single)	9	040-5000-XX
<i>Items 25-26 are secured to Item 1 by: #8 X 1/2" HWH AB (Zinc) (Qty. 13) (234-5101-00)</i>							
<i>-XX Note: for 1/2" use -06 (Qty. 1); for 3/4" use -08 (Qty. 2); for 1" use -09 (Qty. 6)</i>							
				27*	Ground Strap (5") (by Item 12)	1	600-5006-05



Not sold as an assembly, order the individual part(s) actually required.

THE LORD OF THE RINGS Speaker Panel Assy. for the Backbox, 515-6888-03 (Items 1-15) and Assoc. Parts: Backglass Assembly & Pivot Hinges (Left & Right) (Items AP-A - AP-C)

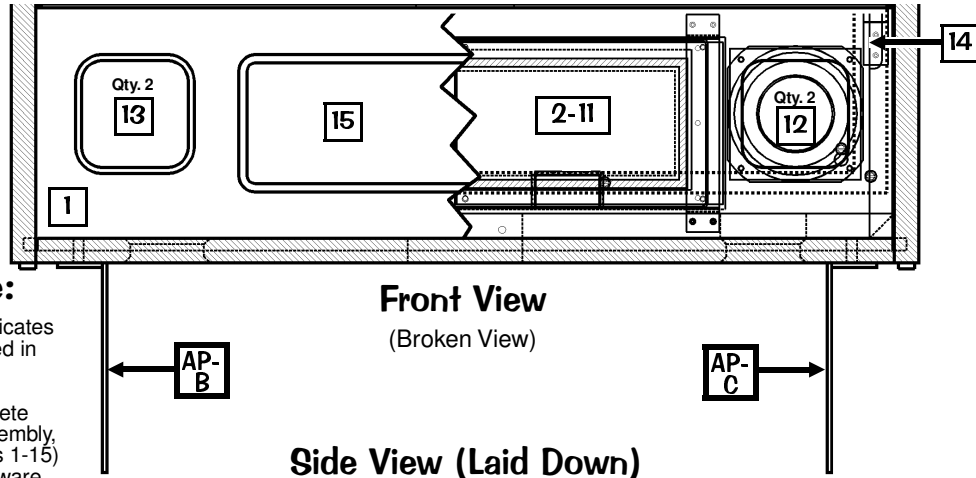

Take Note:

* An asterisk (*) indicates item(s) are not noted in the pictorials.

1. Ordering the complete Speaker Panel Assembly, 515-6888-03 (Items 1-15) will include all hardware.

For clarity, the below drawing *does not show* the speaker(s).

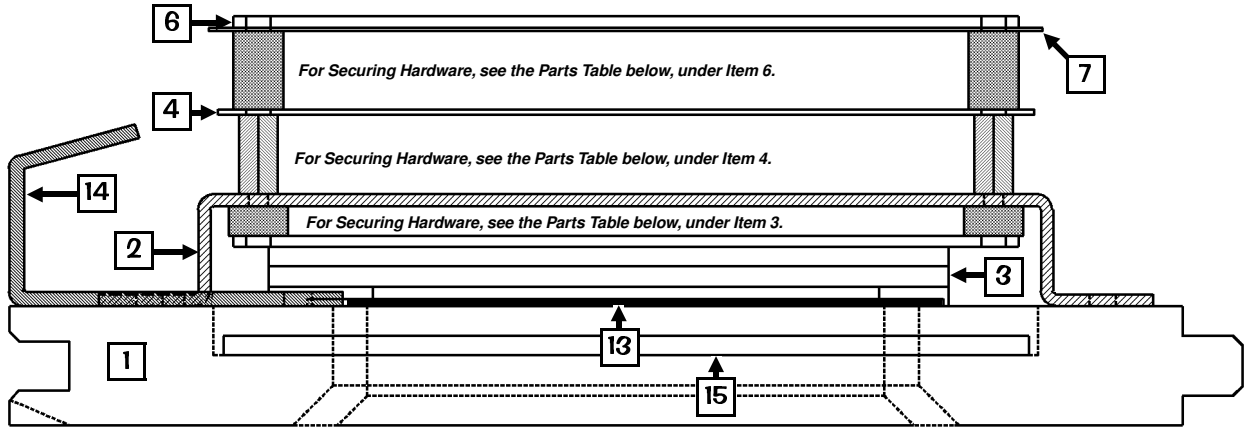

Nº	SPEAKER PANEL PART NAME	QTY.	SPI PART Nº	Nº	INDIVIDUAL PART NAME	QTY.	SPI PART Nº
1	Speaker Panel (Black Wood)	1	525-5515-00	14	Speaker Panel Hook Bracket	2	535-7009-02
2	Dot Matrix Disp. Bd. Mounting Bracket	2	535-8368-01	Items 12, 13 & 14 are secured by: #8 X 3/4" HWH AB (Zinc) (Items 12/13: Qty. 4/per; Item 14: Qty. 2/per) (234-5103-00)			
Item 2 is secured to Item 1 by: #8 X 3/4" HWH AB (Zinc) (Qty. 4/per) (234-5103-00)				15	Plastic Shield (Display Cover)	1	545-5884-00
3	Dot Matrix Display Board 128 X 32	1	520-5052-00	Item 15 is secured to Item 2 by: #6 X 3/8" HWH AB (Zinc) (Qty. 8) (234-5000-00)			
Item 3 is secured to Item 2 by (at corners): 3/16" X 3/8" Spacer Gray (Qty. 4) (254-5000-18) and #6-32 X 1/2" HWH Swage (Serr) Zinc (Qty. 4) (237-5976-03)				The Associated Parts AP-A thru AP-C are also noted in the Backbox Assembly drawings on the previous page.			
Item 3 is secured to Item 4 (at the top center) by: 3/4" X 1/4" Hex Spacer #6-32 Tap (Qty. 1) (254-5008-04) and #6-32 X 1/4" PPH MS (Sems) Zinc (Qty. 1) (232-5200-00)				ASSOC. PARTS ARE NOT INCLUDED WITH BACKBOX/SPKR. PANEL ASSY'S.			
4	Static Shield (Steel Plate)	1	535-6437-00	Nº	ASSOC. BACKBOX PART NAME	QTY.	SPI PART Nº
Item 4 is secured to Item 2 by: 1/2" X 1/4" Hex Spacer #6-32 Tap (Qty. 4) (254-5008-03) and #6-32 X 1/2" PPH MS (Sems) Zinc (Qty. 2, on Left Side only) (232-5202-00)				AP-A	Backglass Assembly (Game Nº 80)	1	See Parts Below
5*	Edge Protector (on Item 4)	2	545-5592-01	ORDER ONLY INDIVIDUAL PART(S) NEEDED:			
6	Display Controller Board FCC-FEB98	1	520-5055-03	AP-A1	Clear Backglass 25.906" X 19.187"	1	660-5038-02
Item 6 is secured to Item 4 by: 1/2" X 5/16" X .144 ID Spacer Tap (Qty. 3) (254-5014-00), #6-32 X 3/4" PPH MS (Sems) Zinc (Qty. 3) (237-5504-00), 1/2" X 1/4" Hex Spacer #6-32 Tap (Qty. 1) (254-5008-03) and #6-32 X 1/4" PPH MS (Sems) Zinc (Qty. 2) (232-5200-00)				AP-A2	LOTR Film Art (#80)	1	830-5280-00
7	RF Shield	1	820-5092-00	AP-A3	Top Plastic Channel - 26"	1	545-5018-15
Item 7 is secured inbetween: "Item 6" and its' mounting hardware described.				AP-A4	Bottom Plastic Lift Channel - 26-1/16"	1	545-5021-01
8*	Ground Strap (25") (on Items 4, 6, 12)	4	600-5006-25	AP-A5	Plastic Edging (Left/Right) - 18-1/8"	2	545-5018-14
9*	1/2" Clamp (Single) (on Item 4)	1	040-5000-06	AP-A6*	Tape (double-sided) (12" Length)	1	626-5005-00
10*	Ribbon Cable, 14-Pin	1	036-5260-00	Note: AP-A6 secures AP-A3--A5 to AP-A1 (only 6" required)			
Item 10 Note: The 14-Pin cable connects the Dot Matrix Disp. Bd. to the Disp. Controller Bd.				AP-B	Pivot Hinge Left	1	535-7999-00
11*	Foam 3/16" Thk. X 1/4" X 36"	6	626-5026-00	AP-C	Pivot Hinge Right	1	535-7999-01
Above Item 11 is self-adhesive. Located between Items 3 & 17. Sold in 12" Lengths only.				Items AP-B & AP-C are secured to Backbox by: 1/4"-20 X 1-1/4" C.B. Sq. Neck (Qty. 4) (231-5003-00), 1/4"-20 Flange Nut (Qty. 4) (240-5300-00) and Fend Washer 1/4" I.D. X 1" O.D. (Qty. 1) (242-5009-00)			
12	Speaker (Shld.) 4" 8Ω MG Elec #4060SH	2	031-5004-01	Items AP-B & AP-C are secured to Cabinet by: 1/4"-20 X 7/8" Carriage Bolt Sq. Neck (Qty. 2) (231-5014-00), Hinge Spacer (Qty. 2) (530-5099-00), Washer 1/4" I.D. X 7/8" O.D. X 1/8" Yellow (Qty. 1/per) (242-5016-01), Fend Washer 1/4" I.D. X 1" O.D. (Qty. 1/per) (242-5009-00) and 1/4"-20 Flange Nut (Qty. 1/per) (240-5300-00)			
13	Speaker Grill (Black w/no Artwork)	2	535-8081-01				



For Backbox Parts see the previous two pages. **Cabinet - General Parts** ■ & **Switches** □



Enlarged View of Item 19 inside the Coin Door, Item 17. Buttons, Bracket & Decal sold separately. For usage, see Section 3, Chapter 1, Portals Service Menu Introduction, Page 8.

Item 32J (On/Off Switch) is located under the Cabinet (Front Right) directly below the Power Box.

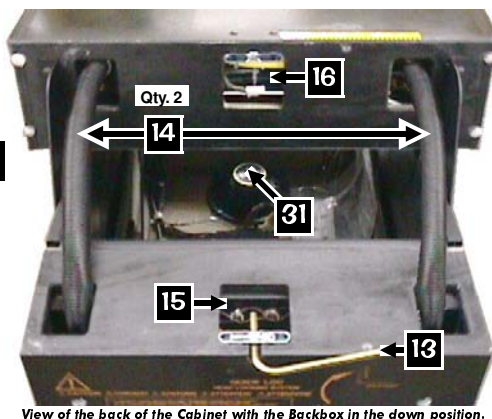

View of the back of the Cabinet with the Backbox in the down position.

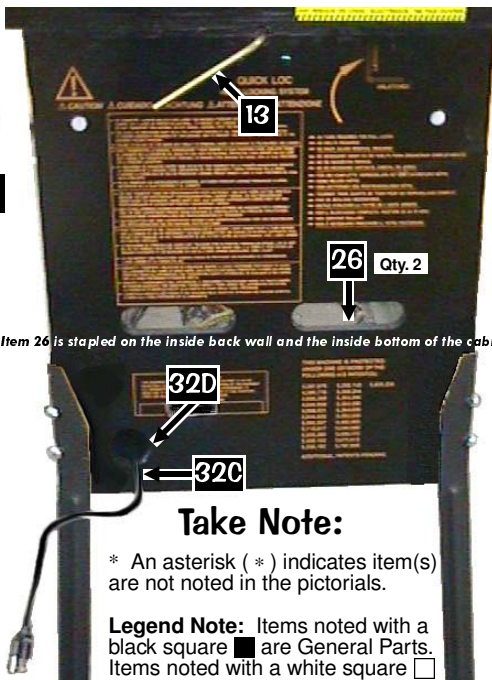

Item 26 is stapled on the inside back wall and the inside bottom of the cabinet.

Take Note:

* An asterisk (*) indicates item(s) are not noted in the pictorials.

Legend Note: Items noted with a black square ■ are General Parts. Items noted with a white square □ are Switches.

Take Note:
 ‡ Item 11, Button Hole Plug (Black) is the Optional Tourne Button Access Hole. If removing for the Optional Tournament Button, save with the game.

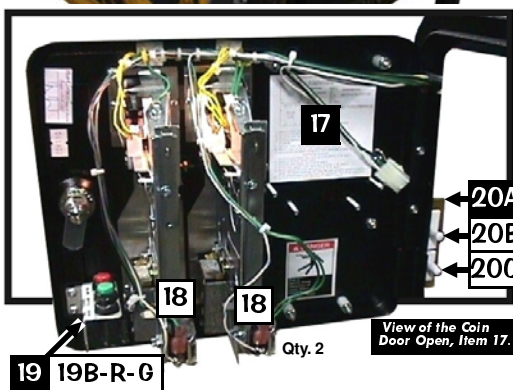

View of the Coin Door Open, Item 17.

Sec. 4: Parts Id. ...

Nº	CABINET PART NAME	QTY.	SPI PART Nº
1	LOTR Screened Cabinet (No Parts)	1	525-5395-15P-80
2	Black Leg & Leveler Assembly	4	500-5921-50
Item 2 is secured by: Leg Bolt Back Plate (535-5703-00) and Leg Bolt 3/8" X 16 X 2-1/2" Hex 5/8" Hd. (2/per) (231-5001-01). To order just a Leg Leveler (3/8" - 16 X 3") use SPI Nº: 500-5017-00. A Leg "without" a Leg Leveler is not available.			
3	Start Button (Red) + Lamp Assembly	1	500-6388-02
Item 3 includes the Switch. FOR SWITCH ONLY see Item 25 on the Next Page.			
4*	#555 Wedge Base Bulb (Clear)	1	165-5002-00
Item 4 is included with Item 3, for just a replacement Bulb use the above number.			
5	Ball Shooter (Plunger) Assembly	1	500-6146-00-07
Item 5 is secured by: Support Plate (Qty. 1) (535-5027-00), #10-32 X 3/8" SHWH (Serr) Swage (Qty. 3) (237-5985-00) and #6 X 5/8" HWH AB (Zinc) (Qty. 2) (234-5002-00).			
IFOR A BREAKDOWN OF PARTS SEE THE BLUE PAGES: Sec. 4, Chp. 2, Page 76.			
6	Flipper Button (Red) Assembly	2	500-5026-32
Item 6 is secured by: Pal Nut for Flipper Button (Metal) (Qty. 2) (240-5003-01) and is fitted with: O-Ring 11/32" X 7/32" X 1/16" (Qty. 1/per) (545-5850-00). Item 6 DOES NOT include the Switch. FOR SWITCHES ONLY see Items 23A/B on the Next Page.			
7	Rear Glass Channel 20-3/8" Length	1	545-5038-00
8	Plastic Channel 42-5/8" Lg. (Left/Rt.)	2	545-5017-00
9	Side Armor "with holes" (Left & Right)	2	535-7297-02
Item 9 is secured by: Pem Stud 1/4 X 1" FH (Qty. 2/per) (237-6116-01), 1/4-20 Flange Nut (Qty. 2/per) (240-5300-00) and #8 X 5/8" T20 Tamper Proof (Qty. 2/per) (237-5947-00)			
10	Front Molding - Black	1	500-5575-02-00
Item 10 requires: Self-Adhesive Foam Rubber 3/8" X 3/16" X 20-3/8" (626-5001-00).			
11‡	Button Hole Plug (Blk) (Happ #52-6214-00)	1	500-6566-00
12	P/F Glass (Tmprd.) 21" X 43" X 3/16"	1	660-5001-00

Nº	CABINET PART NAME	QTY.	SPI PART Nº
13	Hex Key Allen Wrench 5/16"	1	777-0001-00
14	Corrugated Tubing Black 1 1/4"ø X 2.6' Lg.	2	605-5008-00
Above Item 14 covers the Cables Wiring Harnesses going into the Backbox from the Cab.			
15	#1 Roto Lock Male (R2-0055-02)	1	355-5006-01
Item 15 is secured by: #10-24 X 1-3/4" Carr. Bolt Sq. Neck (Qty. 2) (231-5022-00), #10-24 Nylon Stop Nut (Qty. 2) (240-5206-00) and #10 Washer 7/32" X .5" X 1/16" (Qty. 2) (242-5003-00)			
16	#1 Roto Lock Female (on Backbox)	1	355-5006-02
17	Coin Door (with Validator) USA only	1	500-5018-172
Item 17 is secured by: 1/4"-20 X 1-1/4" Carriage Bolt Sq. Neck (Qty. 4) (231-5003-00) 1/4"-20 Flange Nut (Qty. 4) (240-5300-00) and Fend Washer 1/4" I.D. X 1" O.D. (Qty. 3) (242-5009-00) Note: For Coin Door other than USA call Technical Support for SPI Part Nº.			
	Coin Door Sw. (USA) (Happ Control)	2	180-5024-01
18	FYI: Coin Dr. Sw. (USA) (Coin Control)	0	180-5024-00
	FYI: Coin Door Switch (¥ Japan)	0	180-5091-00
19	Bracket for below Portals™ Switches	1	535-6860-03
19B	Push-Button Portals™ Switch (Black)	1	180-5192-00
19R	Push-Button Portals™ Switch (Red)	1	180-5192-02
19G	Push-Button Portals™ Switch (Green)	1	180-5192-04
Ordering Note: Securing hardware for switches included. For Decal Kit, see Page 63.			
20	Dual Switch Assembly	1	500-5808-00
ORDERING ABOVE (ITEM 20) ASSEMBLY PART Nº WILL INCLUDE:			
20A	Mounting Bracket	1	535-6958-00
20B	Playfield Power Interlock Sw. (Top)	1	180-5136-00
20C	Memory Protect Switch (Bottom)	1	180-5000-01
Item 20 is secured to Cabinet by: #8 X 1/2" HWH AB (Zinc) (Qty. 2) (234-5101-00)			

Parts Table & Views continue on the next page.



Cabinet Back Lights are located on the Wood Back Panel:
 See the Blue Pages, Section 4, Chapter 2, Drawings for Major Assemblies ... , Pages 94-95.
For General Bulbs & Sockets:
 See these Pink Pages, Section 4, Chapter 1, Parts Identification & Location, Pages 72-74

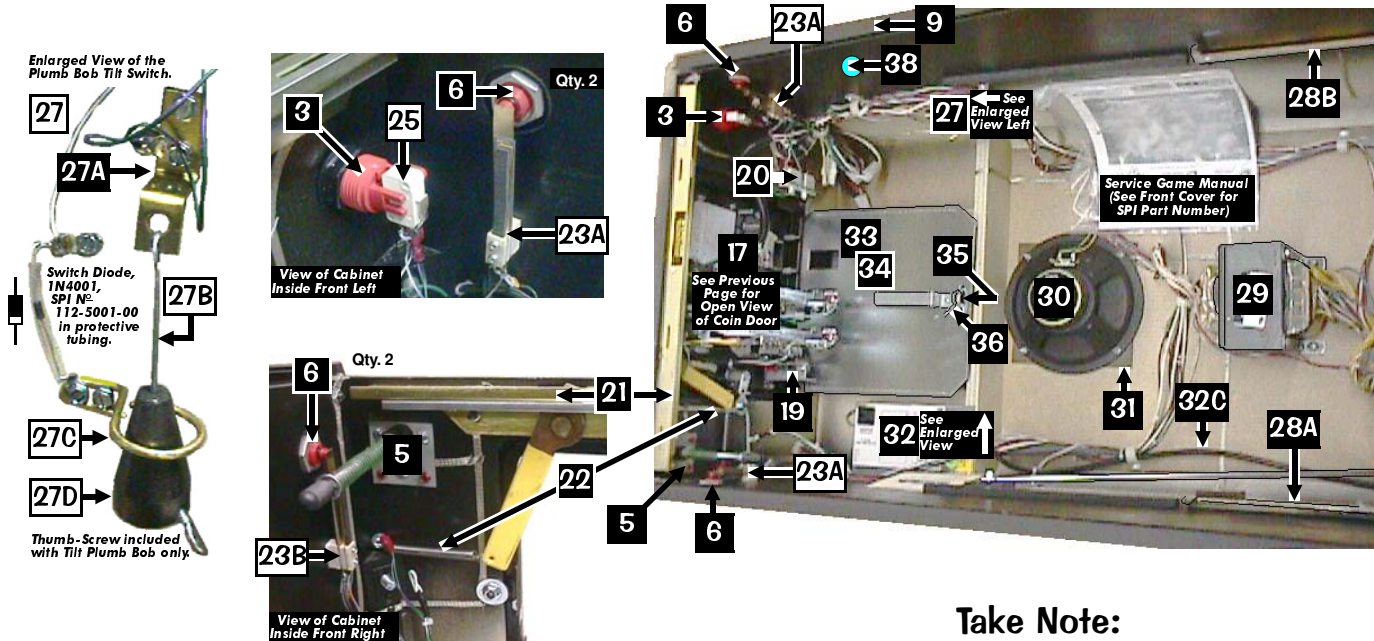
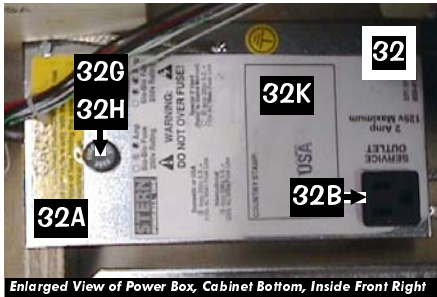

Take Note:

* An asterisk (*) indicates item(s) are not noted in the pictorials.

Legend Note: Items noted with a black square ■ are General Parts. Items noted with a white square □ are Switches.

Nº	INDIVIDUAL PART NAME	QTY.	SPI PART Nº	Nº	INDIVIDUAL PART NAME	QTY.	SPI PART Nº
<i>Parts Table & Views continue on the previous page.</i>							
21	Front Molding Lockdown Assembly	1	500-6509-00	31	Speaker Grill 7" X 7"	1	545-5072-03
Item 21 is secured by: #10-24 X 1-1/4" Carr. Bolt (Qty. 2) (231-5012-00), #10-24 Keps Nut (Qty. 2) (240-5207-00), #8 X 5/8" HWH AB Zinc (Qty. 4) (234-5102-04) and #10 Washer 7/32" ID X 1/2" OD X 1/16" (Qty. 2) (242-5003-00)				Items 30 & 31 are secured by: #6-32 X 1-1/4" Fin Shank Screw (Qty. 4) (237-5883-00) and #6-32 Keps Nut (Qty. 4) (240-5008-00)			
22	Lockdown Spring (connected to handle)	1	265-5008-00	32	Power Input Box Sub-Assy.	1	515-5360-07
23A	Flipper Switch - Self-Cleaning	2	180-5160-00	ORDERING ABOVE (ITEM 32) SUB-ASSY. PART Nº WILL INCLUDE:			
23B	Flipper Sw. - X2 Stack for Lwr./Uprr. Flipper(s)	0	180-5164-00	32A	Power Box (Plain)	1	535-5932-00
24*	Foam Strip (2 on 23A; 1 on 23B)	3	626-5042-00	32B	Service Outlet (for USA)	1	180-5008-01
25	Start Button Switch (ONLY)	1	180-5174-00	32C	Line Cord 10' ROJ 3" Max.	1	034-5000-10
26	Grills 2-1/2" X 18" (on Back & Bottom)	2	545-5072-02	32D	Recessed Cup for Line Cord	1	545-5122-00
27	Cabinet Plumb Bob Tilt Switch	1	See Parts Below	32E*	Line Filter	1	150-5000-00
ORDER ONLY INDIVIDUAL PART(S) NEEDED:							
27A	Bracket for Hanger Wire	1	535-5221-00	32F*	Varistor TNR159211KM	1	150-5001-00
27B	Hanger Wire	1	535-5319-00	32G	Fuse 8 Amp 250v Slo-Blo (Domestic)	1	200-5000-05
27C	Contact Wire Form	1	535-7563-01	32H	Fuse Holder	1	205-5001-00
27D	Plumb Bob Weight (includes Thumb-Screw)	1	535-5029-00	32I*	On/Off Switch Bracket	1	535-8318-00
Items 27A & 27C are secured by: #8 X 1/2" HWH AB (Zinc) (Qty. 4) (234-5101-00)				32J	On/Off Rocker Sw. (APEM R2101C5NBB)	1	180-5001-03
28A	Slide & Pivot Support Bracket - Right	1	535-5990-00	32K	Power Box Decal	1	820-6123-03
28B	Slide & Pivot Support Bracket - Left	1	535-5989-00	33	Cash Box Plastic Bottom	1	545-5090-00
Items 28A & 28B are secured by: #10-24 X 1-1/4" Carriage Bolt Sq. Neck (3/per) (231-5012-00) and #10-24 KEPS Nut (3/per) (240-5207-00)				34	Cash Box Cover (Validator)	1	535-5013-03
29	Transformer 5.7v AC (with Ballast Winding)	1	010-5012-01	35	Cash Box Lock Bracket (wire)	1	535-7562-00
Item 29 is secured by: 1/4"-20 X 5/8" PPH MS (Zinc) (Qty. 4) (237-5854-00) and 1/4" Split Lock Washer (Qty. 4) (244-5000-00)				36	Large Hair-Pin Clip	1	535-7772-00
30	Speaker 8" ø Rd. 8010 4Ω	1	031-5007-00	37	Bracket (to position playfield in cabinet.)	1	535-7354-00
				38*	Optional Meter (+12v DC w/Diode & Bracket)		G-0053-013-102
					Optional Meter (+12v DC w/Diode, No Bracket)		G-0053-013-102A

Pinball Location Maintenance Kit Available: 502-6002-80
 This kit consists of 8 oz. Novus Wax #2 Fine (Red) (675-0003-01), cloth and all Rubber Rings & Bulbs used in this Pinball Machine.



Playfield - General Parts ■, Metal Rails/Ball Guides ■ & Switches (Above)

Nº	ABOVE PLAYFIELD PART NAME	QTY.	SPI PART Nº	Nº	ABOVE PLAYFIELD PART NAME	QTY.	SPI PART Nº
PF	P/F Screened w/ Inserts & NO Parts	1	830-5100-80				
	P/F Complete w/ Inserts & ALL Parts	1	505-6004-80-80				

General Items

1	Arch (Black Metal) for LOTR	1	535-8392-01
Item 1 is secured to the playfield by Item 12 and: #10-32 X 5/16" PH FL U/C MS STL Zinc (Qty. 2) (237-6013-00). Usage Note: When replacing the Arch, order new replacement Nelson Protect Strips (not included) (Qty. 2) (545-5212-02).			
2	Instruction Card (USA) LOTR	1	755-5180-00
Note: Visit www.sternpinball.com for a PDF copy of the Game Instruction Card which will also have any translated Instruction Cards made for this game. Find Game Link or Archives. Spanish 755-5179-02; German 755-5179-03; Italian 755-5179-04; French 755-5179-05.			
3a	Coin Card (2-Sided)	1	755-5400-00
Usage Notes: Use Item 3a (Back: 1 Play 50¢ - 5 Plays \$2) for Adj. 6, Game Pricing, USA 5 Setting, or (Front: 1 Play 50¢ - 3 Plays \$1) for Adj. 6, Game Pricing, USA 8 Setting.			
3b	Coin Card (2-Sided)	1	755-5400-02
Usage Notes: Use Item 3b (Front: 1 Play 50¢) for Adj. 6, Game Pricing, USA 2-7 Setting, (Back: is Blank) for Custom Settings. Availability: See Appendix J (back of manual) for all current Coin Cards (USA, Canada, Euro & other International). If this is a non-US Game, Coin Card(s) provided will differ.			
4	Rubber Lite Cover Red	1	545-5014-02
5	Light Reflector (Silver Color Plastic)	2	545-5409-01
6a	Mini-Mars Lite Cover (Snap-In) Yellow	2	550-5030-06
6b	Mini-Mars Lite Cover (Snap-In) Red	3	550-5030-02
7	Level Assembly	1	515-7214-00
For individual items use: .882" 8MM Vial Mtg. Flange (545-6027-00), Level .8mm Empire #0224 (545-6001-01) or Level Bracket (535-9010-00). Flange secured by: #6-32 X 1/4" PPH MS (no Sems) Zinc (237-5500-00) and #6-32 Keps Nut (240-5008-00)			
Item 10 is secured to the Wood Rail by: #6 X 1/2" HWH AB Zc Red (Qty. 2) (234-5001-02)			
8	Pinball (Steel) 1 1/8" Ø	4	260-5000-00
n/a	Plug-Cap (3/16") Black Plastic	0	545-5232-01
Note: Plug-Cap should plug hole if a Center Post (@ Drain) is used, then removed.			

Brackets with Wire Gates

9	1-Way Gate Mounting Bracket	1	535-9339-01
	Wire Gate (for above)	1	535-9340-00
10	1-Way Gate Mounting Bracket	1	535-9171-01
	Wire Gate (for above)	1	535-9403-00

Brackets for Mounting

11	Playfield Hanger Bracket	2	535-8385-00
Item 11 is secured to the P/F by: #8-32 X 7/8" HWH MS Zinc (Qty. 2/per) (237-5890-00)			
12	Arch Retaining (Hold-Down) Brackets	2	535-8394-00
Item 12 is secured to the P/F by: #8 X 1/2" HWH AB (Zinc) (Qty. 3/per) (234-5101-00)			
13	Bracket, Pad (Blue Rubber) Mount	1	535-9366-00
Item 13 is secured to Item 25 by: #4-40 X 5/16" PFH Under Cut (Qty. 1) (237-6151-00)			
14	Bracket, Crystal Ball Mount	1	535-9381-00
15	Bracket, Ramp Mounting	6	515-6508-00
Item 15 is secured by: #6 X 1/2" PTH A (Zinc) (Qty. 2/per) (237-5809-00)			

Brackets for Ball Stops, Traps or Protect

16	Snubber Wire 3/8" (below Flippers)	2	535-5373-01
17	Bracket, P/F Protect VUK Hole Edge	1	535-9399-00
Item 17 is secured by: #8 X 1/2" HWH AB (Zinc) (Qty. 1) (234-5101-00)			
18	Bracket, Gold (under Wire Ramp, Plastic -14)	1	535-9401-00
Item 18 is secured by: #6-32 X 3/8" PPH (Qty. 2) (232-5201-00) and #6-32 Nylon Stop Nut (Qty. 2) (240-5005-00)			
19	Bracket, Snubber VUK Ball Stop	1	535-8250-00
Item 19 is secured by: #8 X 1/2" HWH AB (Zinc) (Qty. 2) (234-5101-00)			

Wood Back Panel & Wood Rails

20	Back Panel (Plain, No Parts)	1	525-5636-00
21	Wood Rail (Left) 38"	1	525-5007-03
22	Wood Rail (Right) 40 1/2"	1	525-5007-16
Items 21 & 22 are secured by: #6 X 1/4" PFH A Zinc (Qty. 5/per) (237-5804-00)			

Metal Flat Rails, Wire Forms & Ball Guides

23	Metal Rail (Center Drain under Arch)	1	535-8393-00
24	Metal Rail (#1, Left)	1	535-9280-00
25	Metal Rail (#2, Inner Left, with Blue Rubber)	1	535-9281-00
26	Metal Rail (Inner Left Short)	1	535-9283-00
27	Metal Rail (Short Curve) (Welded Asm.)	1	515-7331-00
28	Metal Rail (#5, Left of Top Lanes)	1	535-9284-00
29	Metal Rail (#3, Right)	1	535-9282-00
30	Metal Rail (Welded Assembly)	1	515-7332-00
Items 23-30 are secured at Perm Studs by: #8 Washer (Qty. 1/per) (242-5005-00), #8-32 Nylon Stop Nut (Qty. 1/per) (240-5102-00) and/or #8 X 1/2" HWH AB (Zinc) (Qty. 1/per tab where required) (234-5101-00)			
31	Wire Form (on Plastic Ball Guide, Item 35)	2	535-5642-00
32	Ball Guide Rail (.12" Ø) 2.75"	1	535-5356-15
33	Ball Guide Rail (.12" Ø) (#4 Right)	1	535-9285-00
34	Ball Guide Rail (.12" Ø) 1.5"	1	535-5356-20
35	Ball Guide (Plastic, Long Clear)	2	550-5037-01

Miscellaneous

36	Pad (Blue Rubber)	1	626-5057-00
Item 36 is secured to Item 25 by: #4-40 X 5/16" PFH U-Cut (Qty. 1) (237-6151-00)			
37	Crystal Ball (Drilled) 1 1/4" Ø (#AF1370108)	1	515-7344-00R
	Crystal Ball (Non-Drilled)	1	545-6091-02
38	Balrog (Plain, No Parts)	1	545-5083-00
Item 38 Note: For Associated Parts & better views, see The Blue Pages (Pg. 87).			
39	Barad-dûr Tower (Plain, No Parts)	1	545-5082-00
Item 39 Note: For Associated Parts & better views, see The Blue Pages (Pg. 89).			
40	Saruman	1	880-5080-00
41	Gandalf The White (riding Shadowfax)	1	880-5076-00
42	Uruk-Hai Warrior (no helmet, carrying head)	1	880-5068-00
43	Ringwraith	1	880-5064-00
44	Aragorn (with Torch, riding horse)	1	880-5075-00
45	Uruk-Hai Warrior (with helmet on)	1	880-5070-00
46	Uruk-Hai Mauhur (no helmet)	1	880-5069-00
47	Frodo	1	880-5072-00
48	Gollum	1	880-5063-00
49	Samwise	1	880-5073-00
50	Pippin	1	880-5071-00
51	Merry	1	880-5078-00
Items 40-51 Note: For better views, see The Blue Pages (Pg. 90).			

Switches

A	Micro Switch (Roll-Under Gate)	2	180-5190-28
Switch has a Diode (1N4004) (112-5003-00). Can be replaced with (1N4001) (112-5001-00).			
Items A requires a Switch Body Protect Plate (Qty. 1/per) (535-6539-00) & is secured by: #2-56 X 1/2" HWH Sr (Qty. 2/per) (237-5937-02)			

Pinball Location Maintenance Kit Available: 502-6002-80

This kit consists of 8 oz. Novus Wax #2 Fine (Red) (675-0003-01), cloth and all Rubber Rings & Bulbs used in this Pinball Machine.

Ask your distributor about the Deluxe Pinball Location Maintenance Kit which includes Flipper Rebuild Kits!

For Assemblies, Ramps, Switches on Assemblies, Back Panel Parts and other Individual Parts, not listed on this page, view the Blue Pages (75-98).



21 Playfield - General Parts ■, ...Rails... ■ & Switches □ (Above) Continued

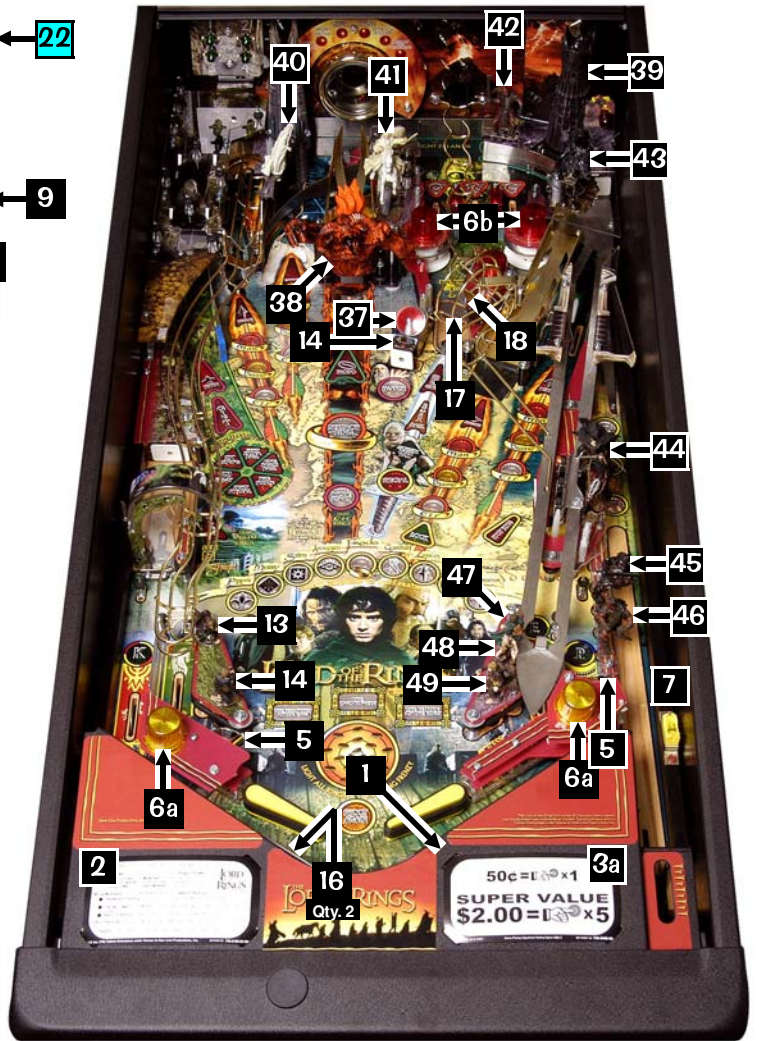
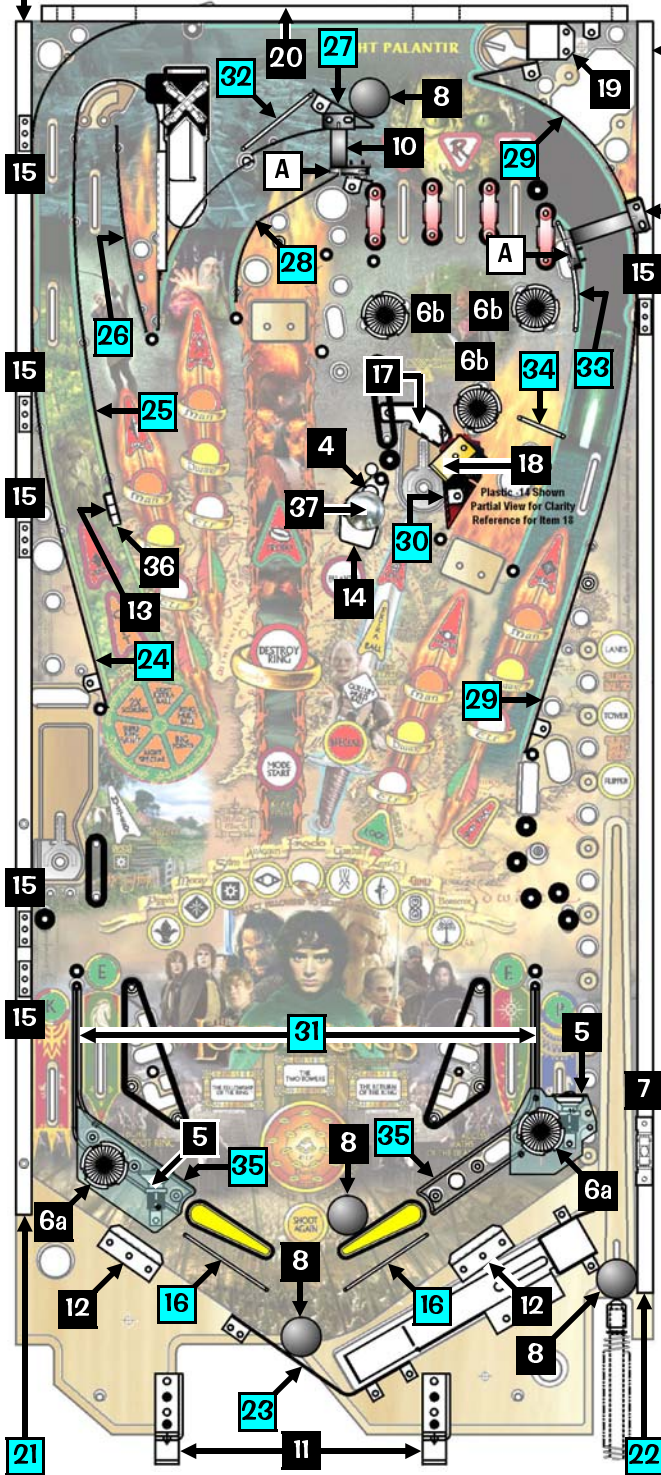

See Appendix J at the back of this manual for all current Cards (USA, Canada, Euro & International) available through your distributor or download via our website (see back of manual cover).

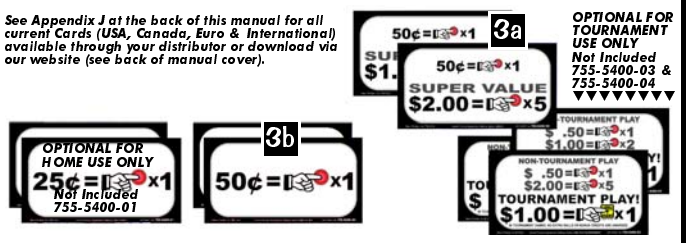

Items 38-51 Not Shown in above view for clarity. For locations see photo above right and for better views, see the Blue Pages, (Pg. 90).

Take Note:

1. Some items or parts may be included with or associated with a Major Assembly or Ramp Assembly; see the Blue Pages, Sec. 4, Chp. 2. for parts required not appearing on this page. If you still cannot find the part required, Call Stern® Pinball, Inc. Technical Support, 1-800-542-5377 or 1-708-345-7700 (Opt. 1).
2. Items 1 & 14 have associated Individual Plastics and/or Decals. These pieces are not available individually. For the Plastic and/or Decal Kits (or views), see the page after next, Playfield - Plastics (Screened & Clear) & Decals, Page 67.
3. Legend Note: Items noted with a black square ■ are General Parts. Items noted with a cyan square ■ are Rails. Items noted with a white square □ are Switches.

Parts Identification & Location

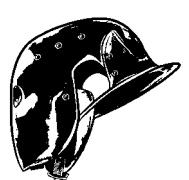

Sec. 4: Parts Id. ...

Playfield - General Parts & Switches (Below)

Nº BELOW PLAYFIELD PART NAME QTY. SPI PART Nº

General Items

1	Insulation Fiche Paper (under Flippers)	2	545-5721-00
2	Diode Terminal Strip 2-Lug (810) Isolated	5	055-5203-00

Note: Item 2 (Qty. 1) is located in the Cabinet on the Coin Door.

Item 2 is secured by: #6 X 3/8 HWH AB Zinc (Qty. 1/per) (234-5000-00).

Note: 1N4004 Diodes (112-5003-00) are used in all Diode applications. 1N4001 Diodes can be used for Switches and/or Coils. See Sec. 5, Chp. 2, P/F Diode Terminal Strip...

3	3A 250v Slo-Blo Fuse	3	200-5000-08
	Fuse Clip Holder (Socket)	3	205-5000-01

Item 3 is secured by: #6 X 1/2" PPH AB (Qty. 1/per) (237-5805-00)

Note: Item 3, Fuse Clip Holder (Socket) 205-5000-01 is part of a set of 12 (205-5000-12). You can order them as individuals (...-01) or a set of 12 (...-12).

4*	Diode Terminal Strip/Fuse Decals	1	820-6221-80
----	----------------------------------	---	-------------

Note: For Decal Descriptions & Locations, see Sec. 5, Chp. 2, Playfield Wiring, Page 105.

Brackets for Mounting

5	Playfield Support Slide Bracket	2	535-6862-02
---	---------------------------------	---	-------------

Item 5 is secured by: #8 X 1/2" HWH AB (Zinc) (Qty. 2/per) (234-5101-00) and #8-32 X 5/8" HWH Swage (Serr) Zinc (Qty. 1/per) (237-5975-03)

6	Edge Slide Bracket (Extended)	2	535-5988-01
---	-------------------------------	---	-------------

Item 6 is secured by: #4 X 1/2" PFH (Zinc) (Qty. 5/per) (237-5840-00)

7	Pivot Pin Bracket Welded Assembly	2	500-5329-03
---	-----------------------------------	---	-------------

Item 7 is secured by: #8-32 X 5/8" HWH Swage (Serr) Zinc (Qty. 2/per) (237-5975-03)

8	Bracket, Back Panel Mounting	2	535-8964-00
---	------------------------------	---	-------------

Item 8 secures Item 23 (prev. page) by: #8 X 1/2" HWH AB (Zc) (Qty. 3/per) (234-5101-00)

Switches & Misc. PC Boards

A	Micro Sw. (Roller Actuator, Lite Force)	5	180-5119-02
---	---	---	-------------

B	EOS Switch Flipper (on Flippers)	2	180-5149-00
---	--	---	-------------

C	Stack (Blade) Switch (on Slingshots)	4	180-5054-00
---	--	---	-------------

D	Switch Asm. (180-5157-00) (Shooter Lane)	1	500-6096-00
---	--	---	-------------

E	Micro Sw. Roll-Over Right Brkt. Assy.	11	500-6227-02
---	---------------------------------------	----	-------------

Items D & E are secured by: #8 X 1/2" HWH AB (Zinc) (Qty. 2/per) (234-5101-00)

F	Micro Sw. (Heavy Duty "Y" Flat Actuator)	2	180-5116-01
---	--	---	-------------

Items A, D & F require a Switch Body Protect Plate (535-6539-00) which is secured by: #2-56 X 1/2" HWH Serr (Qty. 2) (237-5937-02) and #2-56 Hex Nut (Qty. 2) (240-5301-00).

G	Micro Switch (on Pop Bumpers)	3	180-5015-03
---	---------------------------------------	---	-------------

H	Switch Asm. (180-5186-00) (30° Eject)	1	500-6521-00
---	---------------------------------------	---	-------------

I	Switch & Target Assy. 1" Sq. (White)	2	515-5162-08
---	--------------------------------------	---	-------------

J	Sw. & Target Assy. 1 1/2" Rect. (Wht.)	1	515-5027-08
---	--	---	-------------

Items I & J are secured by: #8 X 1/2" HWH AB (Zinc) (Qty. 2) (234-5101-00)

Note: For more details on Items I & J and/or a break-down of parts, see Appendix I.

K	Dual OPTO TRANS Bd. (on Ball Trough)	1	515-0173-00
---	--	---	-------------

	Dual OPTO REC Board (on Ball Trough)	1	515-0174-00
--	--	---	-------------

L	Single OPTO TRANS Bd. (Orthanc Trough)	1	515-7307-00
---	--	---	-------------

M	Single OPTO REC Board (Orthanc Trough)	1	515-7308-00
---	--	---	-------------

N	Playfield 19-LED PC Board	1	520-5242-00
---	---------------------------	---	-------------

Note: For how Items A-C, F-N are secured or for a better view, see Section 4, Chapter 2, Drawings for Major Assemblies & Ramps, on the individual assemblies noted. For Switches located on the Back Panel, see the Blue Pages, Pages 94-97.

Note: For more details on Item K, L/M & N and/or a break-down of parts, see Section 5, Chapter 4, Printed Circuit Boards, Pages 109 (K) & 142 (L/M), 144 (N).

O	DC Bi-Directional Relay Board	1	520-5066-00
---	-------------------------------	---	-------------

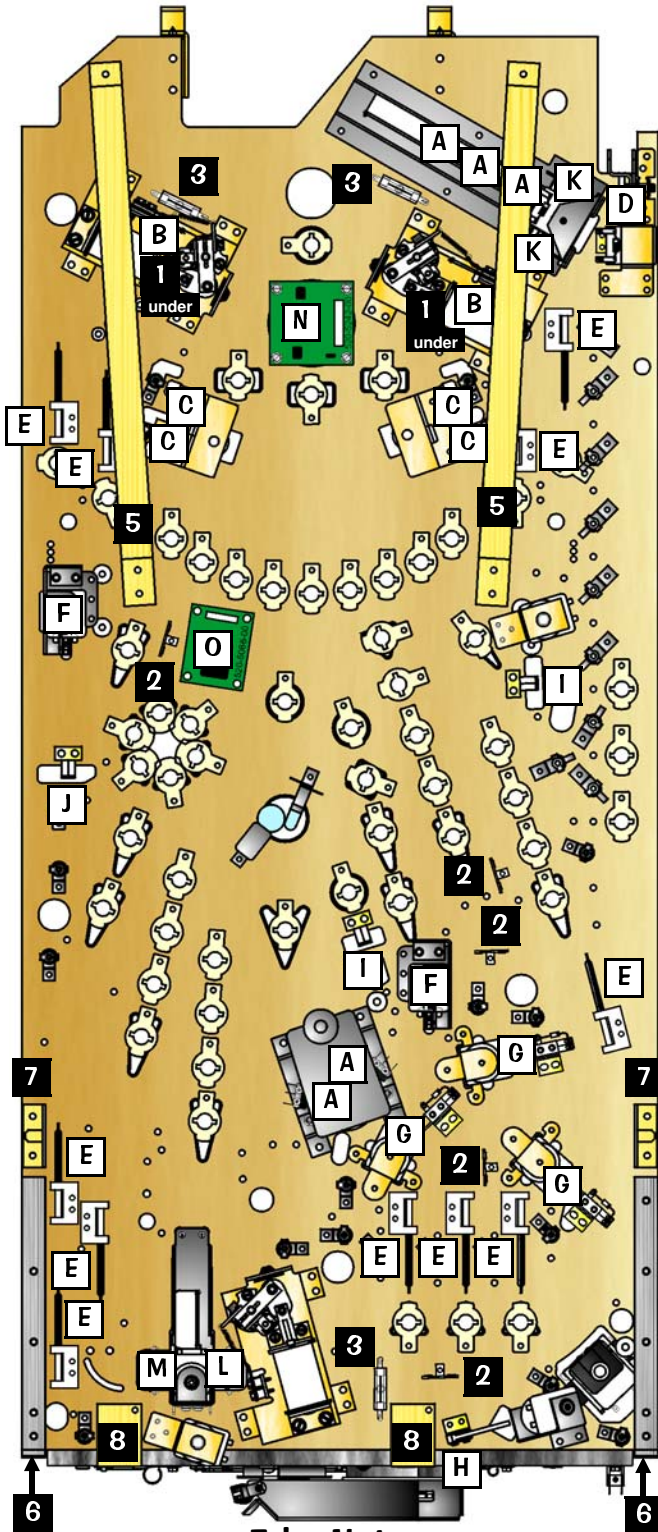

Take Note:

* An asterisk (*) indicates item(s) are not noted in the pictorials.

- For Sockets & Bulbs (drawings & part numbers) see Pgs. 72-74.
- Some items or parts may be included with or associated with a Major Assembly or Ramp Assembly; see the Blue Pages, Sec. 4, Chp. 2. for parts required not appearing on this page. If you still cannot find the part required, Call Stern® Pinball, Inc. Technical Support, 1-800-542-5377 or 1-708-345-7700 (Opt. 1).
- Legend Note:** Items noted with a black square ■ are General Parts. Items noted with a white square □ are Switches and Miscellaneous PC Board(s).

Sec. 4: Parts Id. ...

Pinball Location Maintenance Kit Available: 502-6002-80

This kit consists of 8 oz. Novus Wax #2 Fine (Red) (675-0003-01), cloth and all Rubber Rings & Bulbs used in this Pinball Machine.

Ask your distributor about the Deluxe Pinball Location Maintenance Kit which includes Flipper Rebuild Kits!



Playfield - Plastics (Screened & Clear) & Decals

PLASTICS KIT

SPI PART N^o

Kit: P/F Plastics (Screened & Clear) :

803-5000-80 Kit includes:

Screened & Clear 830-6009-XX Set,

Clear Piece 830-6018-00 & Clear Piece 830-6023-00

Kit: P/F THICK (.177") Plastics (Screened) :

803-5001-80 Kit includes:

Screened 830-6019-XX Set

Attention: No individual Plastic or Decal can be ordered separately, unless noted otherwise.*

Screened Plastic Piece -20 is located on the Exit Scoop (Lower Right Side of Playfield). The piece is riveted into place and must be drilled out to replace (see the Blue Pages, Page 85, for view).

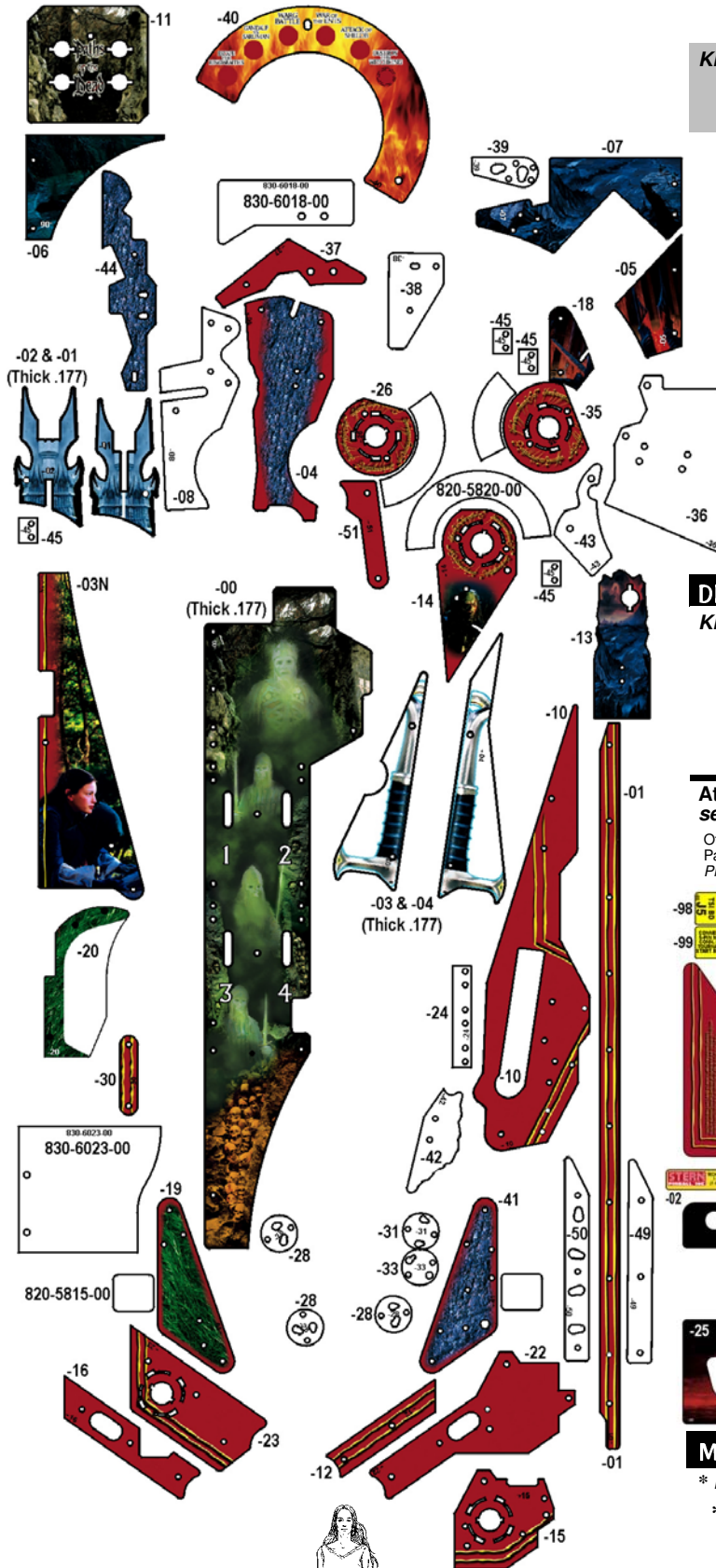

Parts Identification & Location



DECALS KIT

SPI PART N^o

Kit: Game Specific Decals

802-5000-80 Kit includes:

820-6297-01 (Mirror Panel), 820-6342-XX Set, 820-6342-98, 820-6342-99, 820-6347-00 (Mirror Eye), 820-6348-00 (Manget Ring Cover) and 820-6349-XX (Bottom Arch Lt. & Rt.)

Attention: No individual Plastic or Decal can be ordered separately, unless noted otherwise.*

Other miscellaneous plastics and/or decals can be found on the Backbox & Speaker Panel Assemblies (Pages 60-61), Cabinet - General Parts (Pages 62-63) and Playfield - General Parts & Switches (Below) (Page 66).

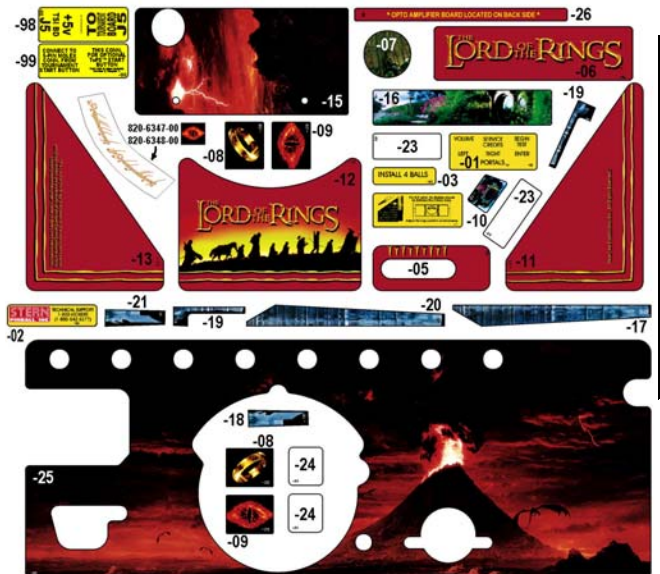

MYLAR

SPI PART N^o

* Not included in the Decals Kit (must be ordered separately):

* Bumper Protectors (Qty. 3) Mylar, 820-5820-00

* Square Ball Drop Pads (Qty. 2), 820-5815-00

* Full Playfield Clear Mylar Sheet, 820-5889-00

Playfield - Rubber Parts Black (Rings Actual Size) †

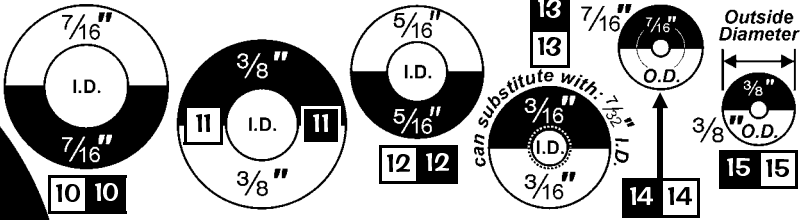
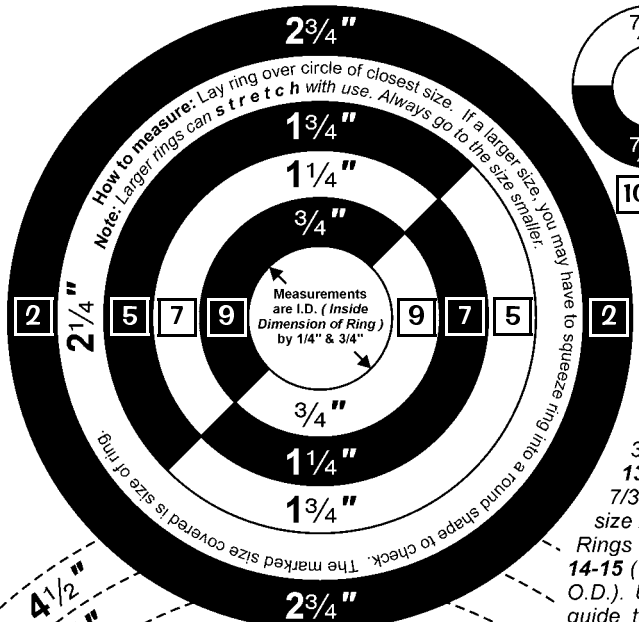

Items 1-13 are measured by the Inside Diameter (I.D.). Items 1-9 and 11 are approximately 1/4" thick. Items 10, 12-15 are approximately 3/16" thick. Item 13 can also be a 7/32" I.D. Ring. The size is imprinted on all Rings except for Items 14-15 (7/16" O.D. & 3/8" O.D.). Use this page as a guide to measure rings where the size imprint or mark does not exist. Size 2 1/4" I.D. (Black or White) was never used. Choose a Ring Size +/- 1/4" I.D. if required.

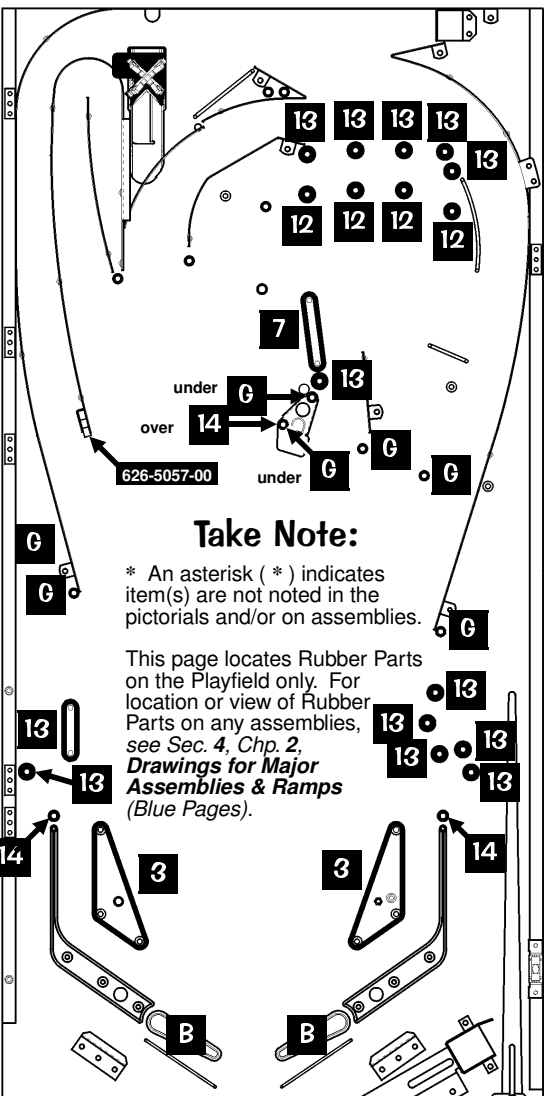

Take Note:

* An asterisk (*) indicates item(s) are not noted in the pictorials and/or on assemblies.

This page locates Rubber Parts on the Playfield only. For location or view of Rubber Parts on any assemblies, see Sec. 4, Chp. 2, Drawings for Major Assemblies & Ramps (Blue Pages).

Sec. 4: Parts Id. ...

Note: Sizes larger than 3" I.D. currently available in Black Only (Not Used): 3 1/2" (545-5348-11); 4" (-12); 4 1/2" (-13); 5" (-14); 5 1/2" (-15); 6" (-16). Sizes Not Shown on this page, listed in the Parts Table below or are noted with N/U (Not Used) are currently not available.

Nº	RUBBER PART NAME	QTY.	SPI PART Nº
A	Small Flipper BLACK Ring		545-5207-00
	Sm. Flipper RED (Soft Duro) Ring		545-5207-22
B	Large Flipper BLK (50 Duro) Ring	2	545-5277-00
	Lg. Flipper RED (Soft Duro) Ring		545-5277-22
	Optional Item B Replacements: Lg. YELLOW (50 Duro) Ring (545-5277-04) or Large YELLOW (40 Duro) Ring (545-5277-06)		
C*	Bumper (Deflector Pad)	3	545-5428-00
D*	Bumper (Grommet) 1138 (A60)	5	545-5105-00
E	Bumper (Post)		545-5009-00
F	Bumper (Post Sleeve, Short)		545-5151-00
	Bumper BLACK (Post Sleeve, Tall)	11	545-5308-00
G	Bumper WHITE (Post Sleeve, Tall)		545-5308-08
H*	O-Ring 1 1/32" x 3/32" x 1/16" (Flipper Buttons)	2	545-5850-00

Nº	SPI PART Nº	QTY.	RUBBER PART NAME	QTY.	SPI PART Nº	Nº
1	545-5348-10		Black 3" I.D. Ring White		-60 N/U	1
2	545-5348-20		Black 2 3/4" I.D. Ring White		-70 N/U	2
3	545-5348-09	2	Black 2 1/2" I.D. Ring White		545-5348-59	3
4	545-5348-08		Black 2" I.D. Ring White		545-5348-58	4
5	545-5348-21		Black 1 3/4" I.D. Ring White		-71 N/U	5
6	545-5348-07		Black 1 1/2" I.D. Ring White		545-5348-57	6
7	545-5348-06	1	Black 1 1/4" I.D. Ring White		545-5348-56	7
8	545-5348-05	1	Black 1" I.D. Ring White		-55 N/U	8
9	545-5348-04		Black 3/4" I.D. Ring White		545-5348-54	9
10	545-5348-18		Black 7/16" I.D. Ring White		-68 N/U	10
11	545-5348-03		Black 3/8" I.D. Ring White		-53 N/U	11
12	545-5348-02	4	Black 5/16" I.D. Ring White		545-5348-52	12
13	545-5348-01	12	Black 3/16" I.D. Ring White		545-5348-51	13
14	545-5348-17	37	Black 7/16" O.D. Ring White		-67 N/U	14
15	545-5348-19	1	Black 3/8" O.D. Ring White		545-5348-69	15

† Items with no Qty. (quantity) are not used in this game. Size and/or quantities may change during production.



Playfield - Metal Posts (Screws) & Nuts (Actual Size) †

Items 1, 3 & 4 Posts can use 3/8" O.D. Black Ring, 545-5348-19 or White Ring, 545-5348-69.

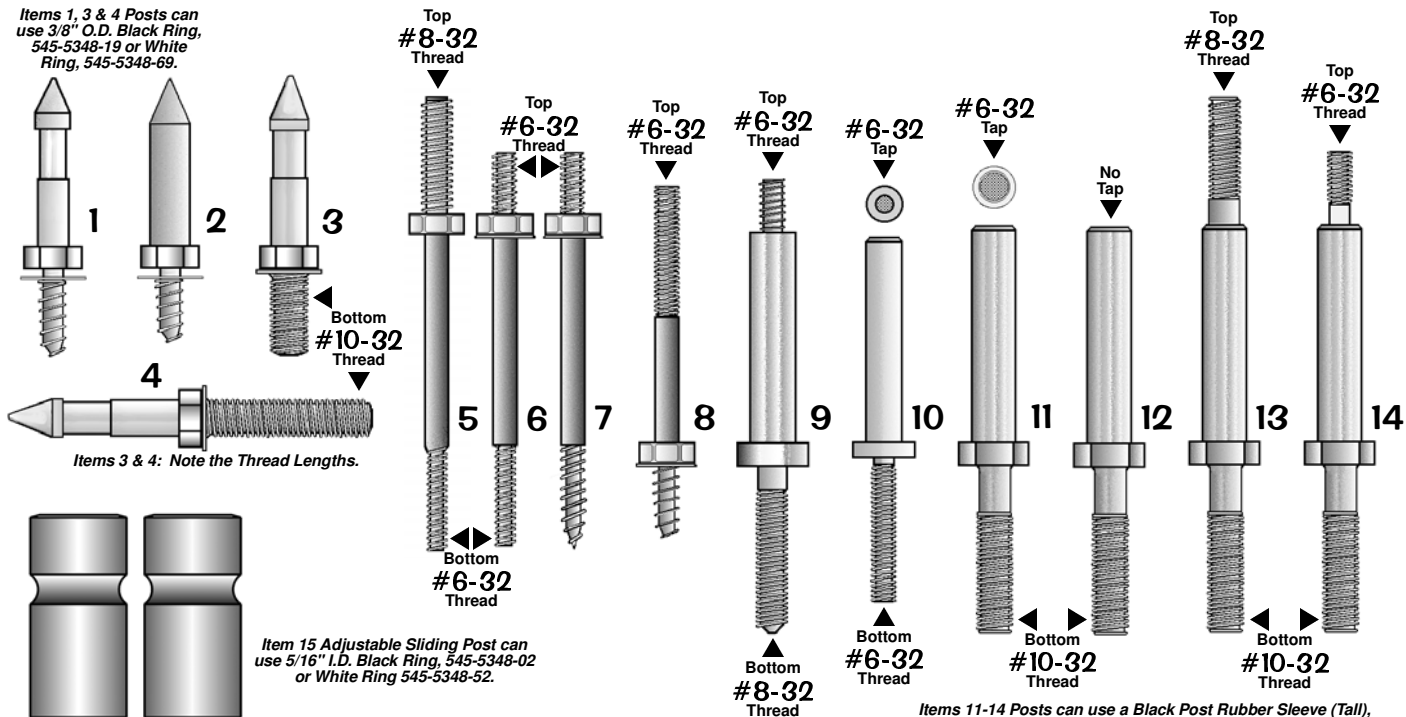

Items 3 & 4: Note the Thread Lengths.

Item 15 Adjustable Sliding Post can use 5/16" I.D. Black Ring, 545-5348-02 or White Ring 545-5348-52.

Items 11-14 Posts can use a Black Post Rubber Sleeve (Tall), 545-5308-00 or White Post Rubber Sleeve (Tall), 545-5308-08.

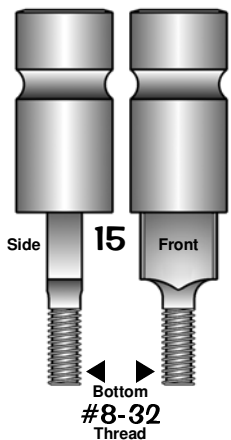

Items A & B are typically used with Hex Spacers above the Playfield.

Item C is typically used with the bottom Cabinet Speaker (used with #6-32 Nylon Stop Nut, 240-5005-00).

Item D is typically used to secure "Item 15 (515-5939-00) in Bumper Bottom Assembly, 515-6459-04".

Note: The "Fins" keep the screw from turning inside the wood hole.

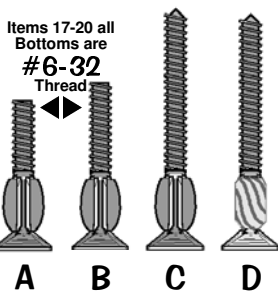

Items 17-20 all Bottoms are #6-32 Thread

Nut Note: All nuts shown with a "✓" are used in this game. The quantities (not specified) vary. The remaining items listed are not used in this game and are noted for reference only (used in prior games).

Shown Below~ • #6-32 Nylon Stop Nut: 240-5005-00 ✓	Shown Below~ • #6-32 KEPS Nut (with Star Washer): 240-5008-00 ✓	Shown Below~ • #6-32 Hex Nut (No Star Washer): 240-5004-00 ✓	Shown Below~ • #6-32 T-Nut: 240-5002-00 ✓	Shown Below~ • 1/4" X 20 Flange Nut: 240-5300-00 ✓
Top & Side Views	Bottom & Side Views	Top View	Bottom & Side Views	Top & Side Views
Nylon Stop Nuts Not Shown:	KEPS Nuts Not Shown:	Hex Nuts Not Shown:	T-Nuts Not Shown:	Miscellaneous Nuts Not Shown:
<ul style="list-style-type: none"> • #6-32 (w/ 1/4" Hex Body): 240-5010-00 • #8-32: 240-5102-00 ✓ • #10-32: 240-5203-00 ✓ • #10-24: 240-5206-00 ✓ • #4-40: 240-5303-00 ✓ • #4-40 (18/8 Stainless): 240-5303-01 • 5/16"-18: 240-5316-00 	<ul style="list-style-type: none"> • #6-32 (w/ 1/4" Hex Body): 240-5011-00 • #8-32: 240-5104-00 ✓ • #10-32: 240-5208-00 ✓ • #10-24: 240-5207-00 ✓ • #4-40: 240-5318-00 	<ul style="list-style-type: none"> • #8-32: 240-5103-00 • #10-32: 240-5201-00 • #10-24: 240-5202-00 ✓ • #10-32 X 3/8": 240-5209-00 • 3/4-16: 240-5315-00 • #2-56: 240-5301-00 ✓ • 7/8"-14: 240-5317-00 	<ul style="list-style-type: none"> • #6-32 (w/Side Cut Off): 240-5002-01 • #8-32: 240-5101-00 ✓ • #10-32 (Black Oxide): 240-5007-00 • #10-32 (w/Side Cut Off): 240-5205-00 • #10-32 X 5/16": 240-5204-00 ✓ • #10-24: 240-5200-00 	<ul style="list-style-type: none"> • Plastic Pal Nut (on Flipper Buttons): 240-5003-00 • Metal Pal Nut (on Flipper Buttons): 240-5003-01 ✓ • #6-32 Wing Nut: 240-5001-00 • #8-32 Wing Nut: 240-5100-00 • #10-24 Wing Nut: 240-5211-00 • 1/4"-20 Wing Nut: 240-5302-00 • 1/4"-20 Toggle Wing: 240-5324-00

† Items with no Qty. (quantity) are not used in this game. Size and/or quantities may change during production.

Nº	METAL POST NAME	QTY.	SPI PART Nº	Nº	METAL POST NAME	QTY.	SPI PART Nº
1	Mini-Post Wood Screw		530-5004-00	11	Post Hex Base #6-32 Tap/#10-32 Bot.	3	530-5332-01
2	Mini-Post Wood Screw (no cut-away)	5	530-5004-01	12	Post Hex Base (No Tap)#10-32 Bot.	1	530-5332-00
3	Mini-Post MS / #10-32 Bot. .4" Thread		530-5005-01	13	Post Hex Base #8-32 Top/#10-32 Bot.		530-5332-02
4	Mini-Post MS / #10-32 Bot. .875" Thread	4	530-5005-00	14	Post Hex Base #6-32 Top/#10-32 Bot.	8	530-5332-03
5	Post Fasten #8-32 Top / #6-32 Bot.		530-5008-00	15	Adjustable Sliding Post (Brass) #8-32 Bot.		530-5621-00
6	Post Fasten #6-32 Top / #6-32 Bot.	6	530-5012-02	A	#6-32 X 3/4" Fin Shank Screw		237-5921-02
7	Post Fstn. #6-32 Top / Wood Scr. Bot.		530-5010-02	B	#6-32 X 7/8" Fin Shank Screw		237-5921-04
8	Post #6-32 Top / Wood Screw Bottom		530-5263-01	C	#6-32 X 1 1/4" Fin Shank Screw	4	237-5883-00
9	Post Fasten #6-32 Top / #8-32 Bot.		530-5007-00	D	#6-32 X 1 3/16" Spirol Fin Shank Screw	9	237-5957-00
10	Post #6-32 Tap / #6-32 Bottom		530-5127-00				

Parts Identification & Location



Playfield - Hex Spacers (Actual Size) †

Hex Spacers:
#6-32
Tap

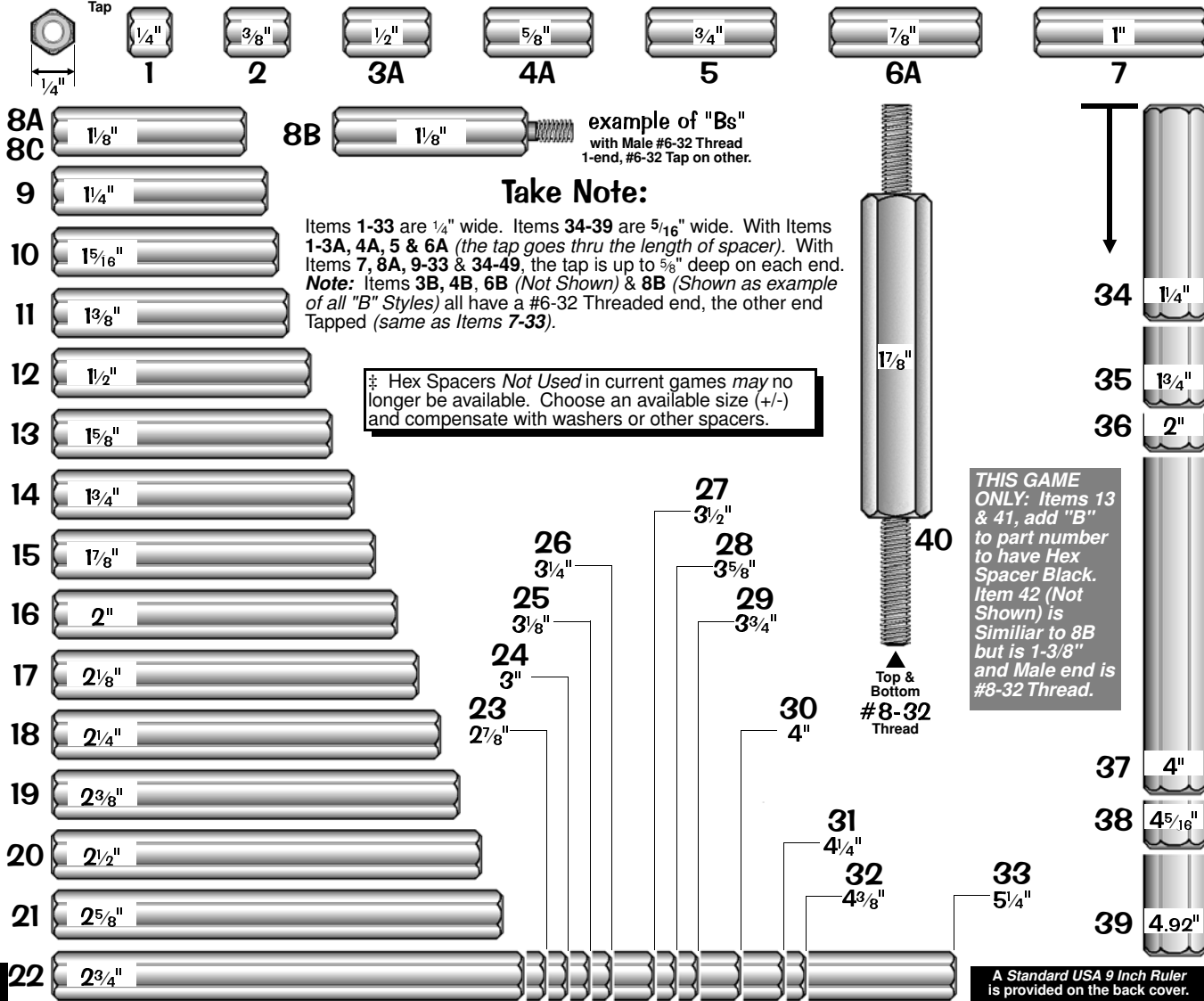

Sec. 4: Parts Id. ...

Nº	HEX SPACER NAME	QTY.	SPI PART Nº	Nº	HEX SPACER NAME	QTY.	SPI PART Nº
1	1/4" X 1/4" : #6-32 Tap (both ends)		254-5008-00	19	2 3/8" X 1/4" : #6-32 Tap (both ends)		254-5008-28
2	3/8" X 1/4" : #6-32 Tap (both ends)		254-5008-12	20	2 1/2" X 1/4" : #6-32 Tap (both ends)		254-5008-16
3A	1/2" X 1/4" : #6-32 Tap (both ends)	5	254-5008-03	21	2 5/8" X 1/4" : #6-32 Tap (both ends)		254-5008-08
3B*	Identical to 3A with #6-32 Thread end		254-5024-03	22	2 3/4" X 1/4" : #6-32 Tap (both ends)		254-5008-15
4A	5/8" X 1/4" : #6-32 Tap (both ends)		254-5008-02	23	2 7/8" X 1/4" : #6-32 Tap (both ends)		254-5008-31
4B*	Identical to 4A with #6-32 Thread end		254-5024-02	24	3" X 1/4" : #6-32 Tap (both ends)		254-5008-14
5	3/4" X 1/4" : #6-32 Tap (both ends)	4	254-5008-04	25	3 1/8" X 1/4" : #6-32 Tap (both ends)		254-5008-19
6A	7/8" X 1/4" : #6-32 Tap (both ends)		254-5008-05	26	3 1/4" X 1/4" : #6-32 Tap (both ends)		254-5008-26
6B*	Identical to 6A with #6-32 Thread end		254-5024-05	27	3 1/2" X 1/4" : #6-32 Tap (both ends)		254-5008-27
7	1" X 1/4" : #6-32 Tap (both ends)	1	254-5008-06	28	3 5/8" X 1/4" : #6-32 Tap (both ends)		254-5008-25
8A	1 1/8" X 1/4" : #6-32 Tap (both ends)	4	254-5008-17	29	3 3/4" X 1/4" : #6-32 Tap (both ends)		254-5008-36
8B	Identical to 8A with #6-32 Thread end		254-5024-17	30	4" X 1/4" : #6-32 Tap (both ends)		254-5008-21
8C	... to 8A with #8-32 Tap (both ends)		254-5031-06	31	4 1/4" X 1/4" : #6-32 Tap (both ends)		254-5008-30
9	1 1/4" X 1/4" : #6-32 Tap (both ends)	1	254-5008-11	32	4 3/8" X 1/4" : #6-32 Tap (both ends)		254-5008-29
10	1 5/16" X 1/4" : #6-32 Tap (both ends)		254-5008-34	33	5 1/4" X 1/4" : #6-32 Tap (both ends)		254-5008-35
11 ‡	1 3/8" X 1/4" : #6-32 Tap (both ends)		254-5008-33	34	1 1/4" X 5/16" : #6-32 Tap (both ends)		254-5018-09
12	1 1/2" X 1/4" : #6-32 Tap (both ends)		254-5008-09	35	1 3/4" X 5/16" : #6-32 Tap (both ends)		254-5018-06
13 ‡	1 5/8" X 1/4" : #6-32 Tap (BLACK)	2	254-5008-13B	36	2" X 5/16" : #6-32 Tap (both ends)		254-5018-07
14	1 3/4" X 1/4" : #6-32 Tap (both ends)	3	254-5008-10	37	4" X 5/16" : #6-32 Tap (both ends)		254-5018-03
15 ‡	1 7/8" X 1/4" : #6-32 Tap (both ends)		254-5008-20	38	4 5/16" X 5/16" : #6-32 Tap (both ends)		254-5018-00
16	2" X 1/4" : #6-32 Tap (both ends)		254-5008-07	39	4.92" X 5/16" : #6-32 Tap (both ends)		254-5018-04
17	2 1/8" X 1/4" : #6-32 Tap (both ends)		254-5008-32	40	1 7/8" X 3/8" : #8-32 Thread (both ends)		530-5285-00
18	2 1/4" X 1/4" : #6-32 Tap (both ends)		254-5008-18	41*	6" X 5/16" : #6-32 Tap (BLACK)	1	254-5018-02B
				42*	1 3/8" X 1/4" : #8-32 Tap (1 end)	1	254-5031-06

† Items with no Qty. (quantity) are not used in this game. Size and/or quantities may change during production.



Playfield - Posts & Spacers (Actual Size) †

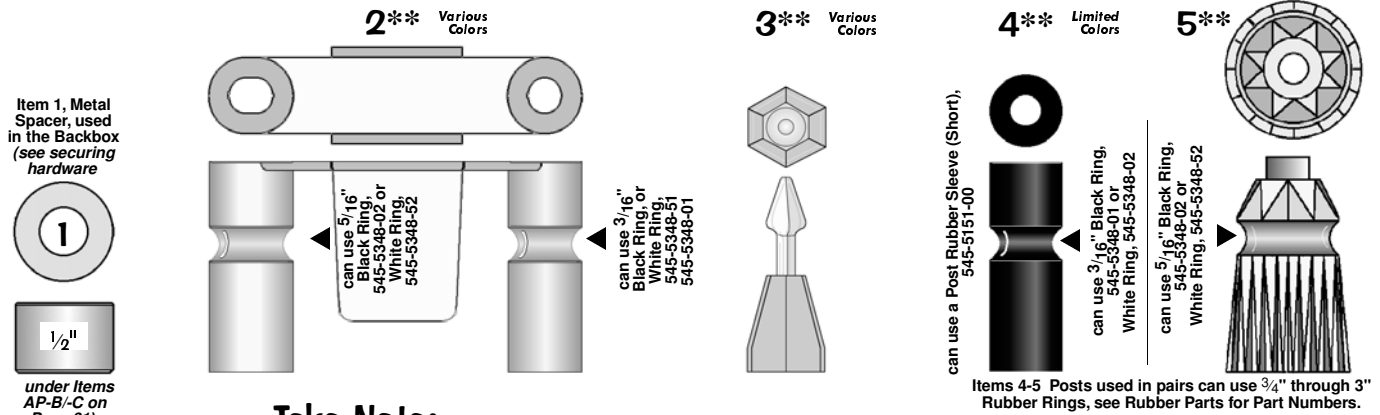

under Items AP-B/-C on Page 61).

Take Note:

PLASTIC PART COLOR CHART					
Nº	Color	Nº	Color	Nº	Color
-00	Black	-06	Yellow	-12	Fluor. Blue
-01	Clear	-07	Orange	-13	Teal Green
-02	Red	-08	White	-14	Gray
-03	Amber	-09	Purple	-15	Luminescent
-04	Green	-10	Fluor. Orange	-16	Gold
-05	Blue	-11	Fluor. Green		

** Items 2, 4 & 5 come in various colors (may not be available in every color). Item 4 is currently only available in the color(s) stated in this game manual (other colors used in prior games may no longer be available). The "-XX" or last 2-Digits in Part Nºs which come in various colors, should be replaced with the desired 2-Digit Nº from the above Color Chart. Some colors may no longer be available for desired item.

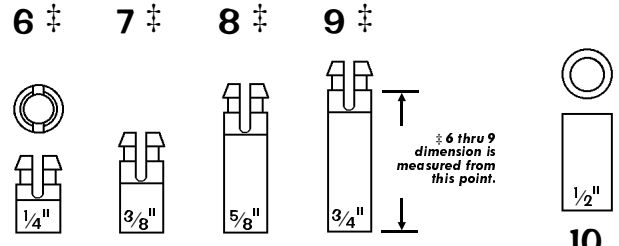

† Items 6 through 9 dimensions are measured from bottom to just under the cut-away. Item 30 dimension is measured from top-to-top of curve. See pictorials with Items 9 & 30.

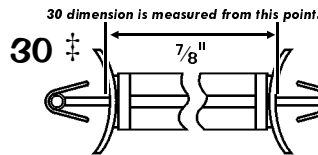

Take Note:

If any one of Items 11-23 Plastic Spacers is not available in the size required, order the smaller sized spacers required to stack sizes together until appropriate size is achieved (e.g. If 1 1/8" is needed but unavailable, order a 1/2" + 5/8" & stack to = 1 1/8").

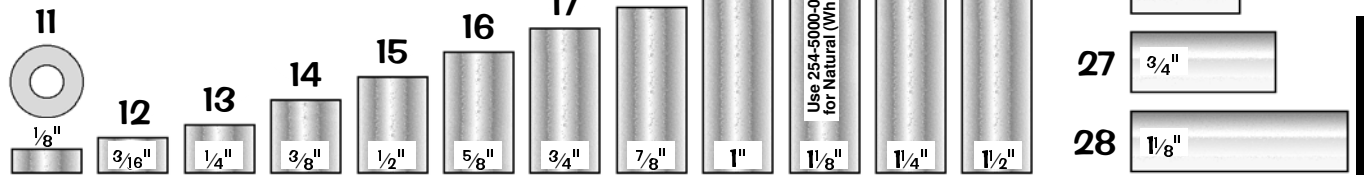

† Items with no Qty. (quantity) are not used in this game. Size and/or quantities may change during production.

Nº	POST & SPACER NAME	QTY.	SPI PART Nº	Nº	POST & SPACER NAME	QTY.	SPI PART Nº
1	3/8" X 1/2" Metal Spacer (Backbox)	2	530-5099-00	14	3/8" X 3/8" Plastic Spacer Gray	4	254-5000-12
2**	Top Lane Plastic Mini-Lite Hood (Red)	4	550-5061-02	15	1/2" X 3/8" Plastic Spacer Gray	9	254-5000-01
Item 2 typically secured by: #6-32 X 1-3/4" PPH MS (Zinc) (Qty. 2/per) (237-5511-00) and Washer 9/64" X 5/16" OD X 1/32" (Qty. 2/per) (242-5017-00), if used.							
3**	Mini-Jewel Plastic Post (Clear)	14	550-5052-01	16	5/8" X 3/8" Plastic Spacer Gray	2	254-5000-14
Item 3 typically secured by: #6 X 3/8" HWH AB (Zinc) (Qty. 1/per) (234-5000-00)							
4**	1 1/16" 1-Groove Plastic Post (Black)	3	550-5059-00	17	3/4" X 3/8" Plastic Spacer Gray	19	254-5000-07
	1 1/16" 1-Groove Plastic Post (Clear)	19	550-5059-01	18	7/8" X 3/8" Plastic Spacer Gray	1	254-5000-11
5**	1-Groove Jewel Plastic Post (Clear)	1	550-5034-01	19	1" X 3/8" Plastic Spacer Gray or Black	1	254-5000-04
Items 4 & 5 typically secured by: Post Fastening Screw #6-32 Top / #6-32 Bottom (Qty. 1/per) (530-5012-02, Item 6 Page 69).							
6 †	1/4" Slf. Rtn. Plastic Spacer White		254-5007-02	20	1 1/8" X 3/8" Plastic Spacer Gray		254-5000-06
7 †	3/8" Slf. Rtn. Plastic Spacer White	8	254-5007-01	21	1 1/4" X 3/8" Plastic Spacer Gray	3	254-5000-05
8 †	5/8" Slf. Rtn. Plastic Spacer White		254-5007-00	22	1 1/2" X 3/8" Plastic Spacer Gray		254-5000-08
9 †	3/4" Slf. Rtn. Plastic Spacer White		254-5007-03	23	1 5/8" X 3/8" Plastic Spacer Gray		254-5000-15
10	1/2" X 1/4" Plastic Spacer White (Narrow)		254-5000-03	24	1/4" X 5/16" X .144" I.D. Metal Spacer	1	254-5014-03
11	1/8" X 3/8" Plastic Spacer Gray		254-5000-19	25	1/2" X 5/16" X .144" I.D. Metal Spacer	3	254-5014-00
12	3/16" X 3/8" Plastic Spacer Gray	4	254-5000-18	26	9/16" X 5/16" X .144" I.D. Metal Spacer		254-5014-04
13	1/4" X 3/8" Plastic Spacer Gray	5	254-5000-02	27	3/4" X 5/16" X .144" I.D. Metal Spacer		254-5014-01
				28	1 1/8" X 5/16" X .144" I.D. Metal Spacer		254-5014-02
				29	1" X 5/16" X .144" I.D. Metal Spacer		254-5001-00
				30 †	7/8" Plastic Spacer Support (Dual-Locking)	4	254-5039-14

Parts Identification & Location



Playfield - Small Bayonet Type Bulbs & Sockets (Actual Size) †

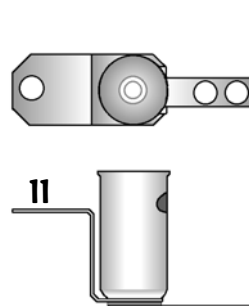
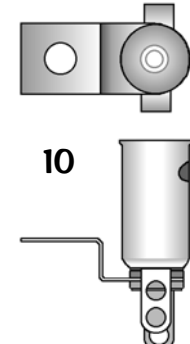
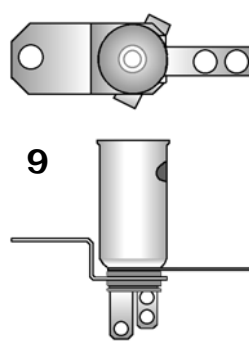
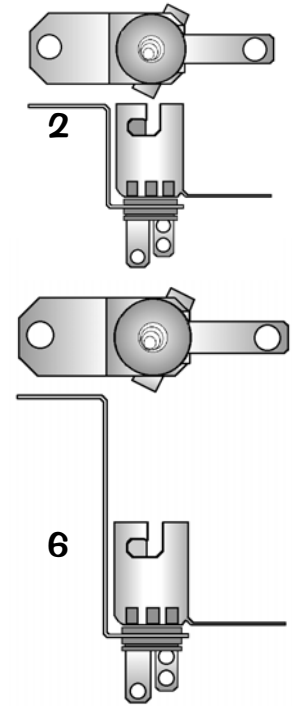
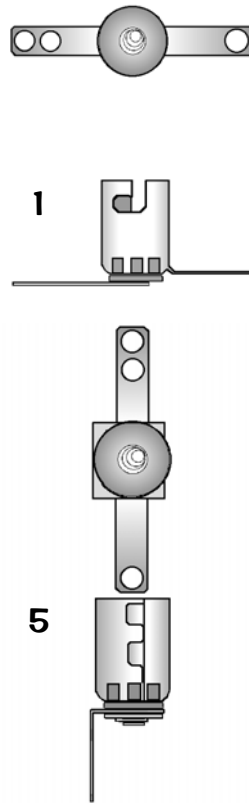
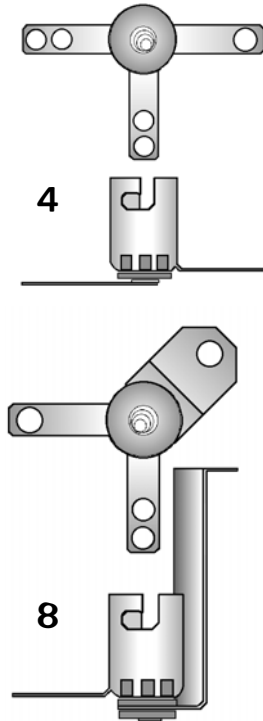
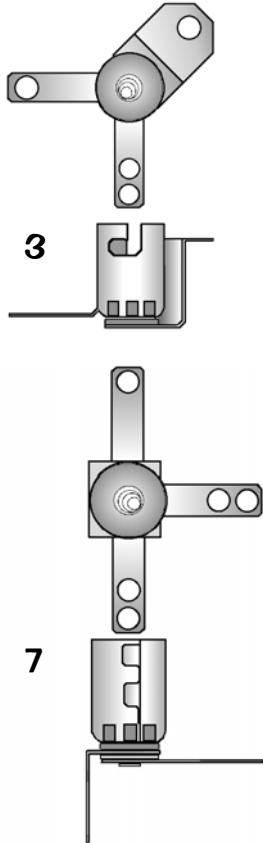
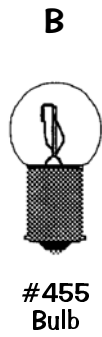
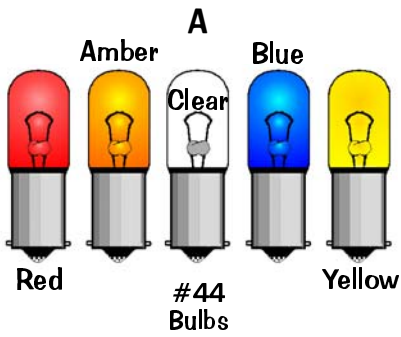

Nº	SMALL BULB or SOCKET NAME	QTY.	SPI PART Nº
A	#44 Bulb (Clear)	42	165-5000-44
A	#44 Bulb (Red)		165-5053-02
A	#44 Bulb (Amber)		165-5053-03
A	#44 Bulb (Blue)		165-5053-05
A	#44 Bulb (Yellow)		165-5053-06
B	#455 Twinkle Bulb		165-5003-00
1	2-Lug Staple Down Socket	10	077-5000-00
2	3-Lug Stand-Up Short Socket	8	077-5008-00
3	2-Lug Stand-Up Short Socket	7	077-5002-00
4	3-Lug Staple Down Socket	6	077-5001-00
5	2-Lug Laydown Socket		077-5003-00
6	3-Lug Stand-Up Long Socket	1	077-5009-00
7	3-Lug Laydown Socket (3 Lugs Flat)	1	077-5006-00
8	2-Lug Stand-Up Long Socket		077-5005-00
9	3-Lug Stand-Up Long Shell Socket		077-5013-00
10	2-Lug Stand-Up Lg. Shell Socket (Gls)	5	077-5031-00

Nº	SOCKET NAME	QTY.	SPI PART Nº
11	1-Lug Stand-Up Long Shell Socket		077-5012-00
12	3-Lug Laydown Socket (2 Lugs Bent)		077-5032-00

† Items with no Qty. (quantity) are not used in this game. Size and/or quantities may change during production.

Sec. 4: Parts Id. ...

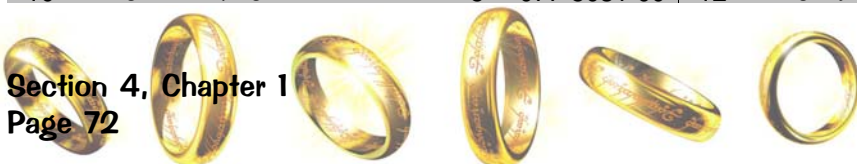

Playfield - Large Bayonet Type Bulb & Sockets (Actual Size) †

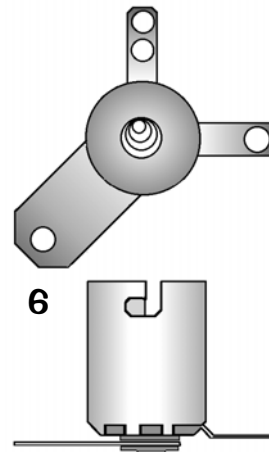
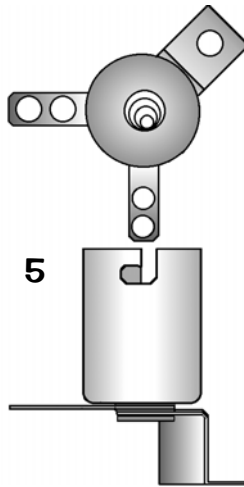
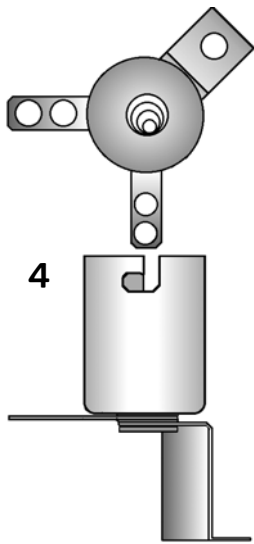
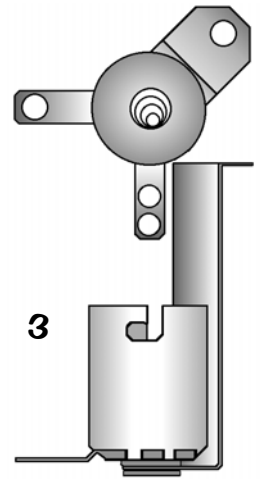
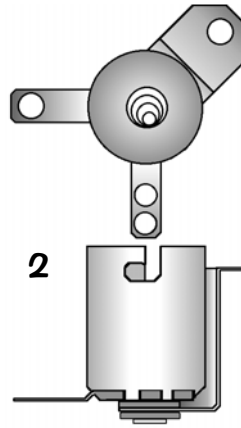
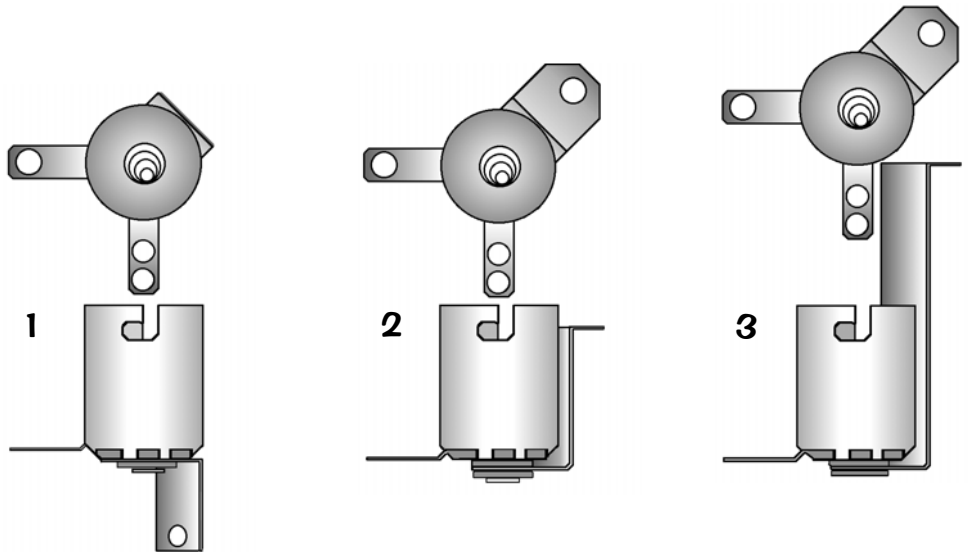
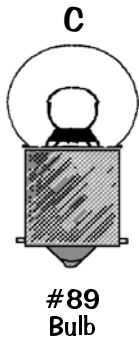

† Items with no Qty. (quantity) are not used in this game. Size and/or quantities may change during production.

Nº	LARGE BULB & SOCKET NAME	QTY.	SPI PART Nº	Nº	LARGE BULB & SOCKET NAME	QTY.	SPI PART Nº
C	#89 Bulb	2	165-5000-89	3	2-Lug Stand-Up Long Socket		077-5102-00
1	2-Lug Laydown Standard Socket	2	077-5100-00	4	2-Lug Stand-Up Rev. Mount Socket		077-5103-00
2	2-Lug Stand-Up Short Socket		077-5101-00	5	2-Lug Stand-Up Rv. Mnt. Short Socket		077-5106-00
				6	2-Lug Straight Leg Socket		077-5107-00

Parts Identification
& Location



Playfield - Wedge Base Bulbs & Sockets (Actual Size) †

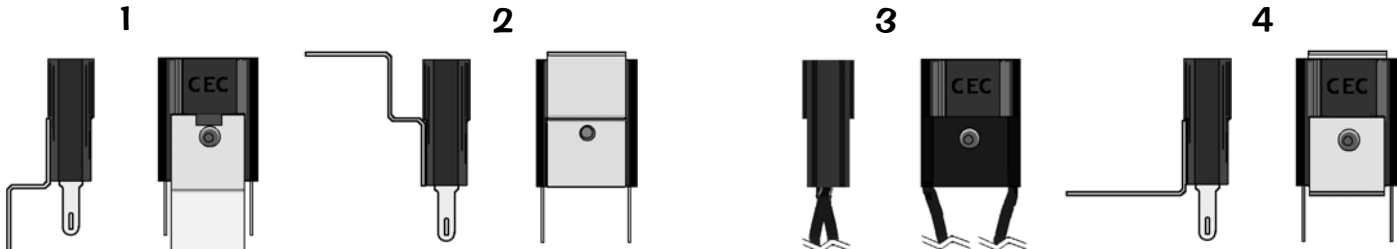
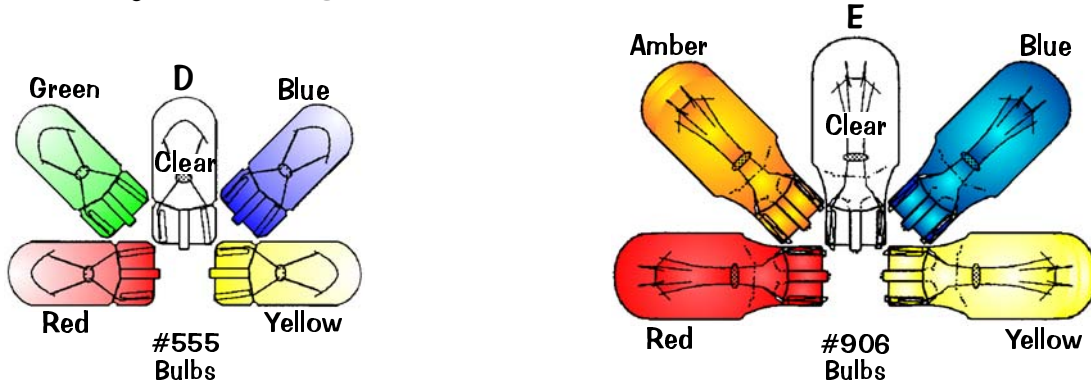

Socket does not have a bracket. Old stock may include an "L" style bracket (on each side) but was never required.



Take Special Note

Item 7a is an IDC (Insulation Displacement Connection) Style Socket (this style is solderless). This socket is secured to the playfield or component by Items 8a or 8b Snap-On Socket Brackets, or may also be snapped into specially cut **Clear and/or Screened Plastic Pieces** (used only when sockets are positioned closely together and/or in a special applications, e.g. on Ramps). If Plastic Pieces are used to mount some 7a or 7b Sockets, it will be noted on Page 67, Playfield - Plastics & Decals.

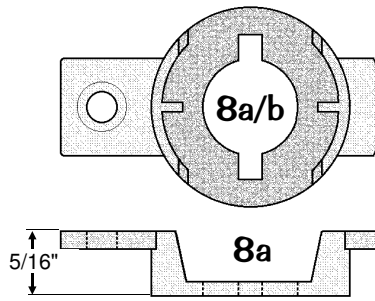

Take Note:

- * An asterisk (*) indicates item(s) are not noted in the pictorials.
- 1. Item 3 Socket has 2 Wires attached are approximately 12" ea.
- 2. Item 5 Socket **was** used on PC Light Boards to position bulbs vertically; Item 5 Socket is secured by "twisting" into place.
- 3. Item D Bulb (#555) can be used in all sockets, *except* Item 6.
- 4. Item E Bulb (#906) can be used in all sockets, *except* Item 5.
- Item 7a Socket is equipped with a *built-in* Diode, 1N4003 (112-5003-00), however, replacement can be made with a 1N4001 Diode (112-5001-00).
- Item 7b Socket is **NOT** equipped with a diode (Not Required).

Note: Always replace with same type bulb in original application.

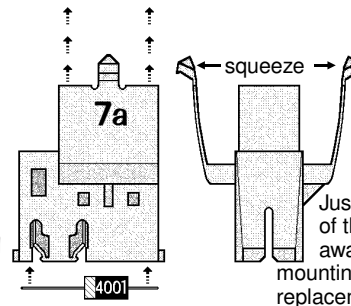
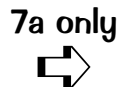

7b is Yellow with No Diode

Just squeeze the "side arms" of the socket together & pull away from the bracket or mounting board for easy Bulb replacement.

Nº	WEDGE BULB & SOCKET NAME	QTY.	SPI PART Nº	Nº	WEDGE BULB & SOCKET NAME	QTY.	SPI PART Nº
D	#555 Wedge Base Bulb (Clear)	41	165-5002-00	1	Wedge Base Socket (Laydown)	3	077-5026-01
D	#555 Wedge Base Bulb (Red)		165-5054-02	2	Wedge Base Socket (Offset)	2	077-5029-00
D	#555 Wedge Base Bulb (Green)	4	165-5054-04	3	W.B. Socket (Bumpers/Special App.)		077-5206-00
D	#555 Wedge Base Bulb (Blue)		165-5054-05	4	Wedge Base Socket (Laydown Gl)		077-5030-00
D	#555 Wedge Base Bulb (Yellow)		165-5054-06	5	#555 <i>only</i> Wedge Base Socket (Twist)		077-5007-00
E	#906 Wedge Base Bulb (Clear)	9	165-5004-00	6	#906 <i>only</i> Wedge Base Socket (Twist)		077-5016-00
E	#906 Wedge Base Bulb (Red)	1	165-5004-02	7a	IDC Snap-On Socket	61	077-5216-00
E	#906 Wedge Base Bulb (Amber)		165-5004-03	7b	IDC Snap-On Socket No Diode	6	077-5216-01
E	#906 Wedge Base Bulb (Blue)		165-5004-05	8a	5/16" Ht. Snap-On Socket Bracket	58	545-5760-18
E	#906 Wedge Base Bulb (Yellow)		165-5004-06	8b*	19/32" Ht. Snap-On Socket Bracket		545-5760-19

† Items with no Qty. (quantity) are not used in this game. Size and/or quantities may change during production.



Drawings for Major Assemblies & Ramps (The Blue Pages)

Overview

Drawings are provided for the Major Assemblies in this game with individual parts of each assembly numbered. Items noted with a white circle ○ are mounted above the playfield; items noted with a black circle ● are mounted below. All numbered parts describe the **NAME, QUANTITY & PART N°**. **ASSOCIATED PARTS (AP-)** are noted and/or viewed with the associated Major Assembly.

For **Cabinet, Backbox** and/or **General Playfield Parts** (not described herein), see the **Pink Pages, 59-74**.



Sec. 4: Drawings ...

⊖ **Coil Note:** ⊖ Either -00B or -00T can be used for coil replacements. -00B or -00T listed is preferable for easier diode access and may differ on game.



Ball Shooter (Plunger) Assembly, 500-6146-00-07 (Items 1-8)

Manually launch the ball into play.

Nº	INDIVIDUAL PART NAME	QTY.	SPI PART Nº	Nº	INDIVIDUAL PART NAME	QTY.	SPI PART Nº
1	Housing (Shooter Assembly)	1	535-5067-02	2	Rod Assembly (w/Black Knob)	1	515-6557-00
Item 1 is secured to the Cabinet by: Support Plate (Qty. 1) (535-5027-00), #10-32 X 1/2" PPH (Sems) Zinc TF (Qty. 3) (237-6033-00), #10 Split Lock Washer (Qty. 3) (234-5003-00) and #6 X 5/8" HWH AB (Zinc) (Qty. 2) (234-5002-00)							
3	Comp. Spring (ORG, .038" ø, 5 5/8" Lg.)	1	266-5001-07	4	Compression Spring (Short Plunger)	1	266-5010-00
5	Bushing, 3/8" I.D. (Oilite)	2	280-5010-00	6	Washer, 3/8" I.D. X 5/8" O.D. X 1/16"	3	242-5014-00
7	Retaining Ring, 3/8" ø Shaft	1	270-5012-00	8	Plunger Tip (Black 50 Duro)	1	545-5276-00

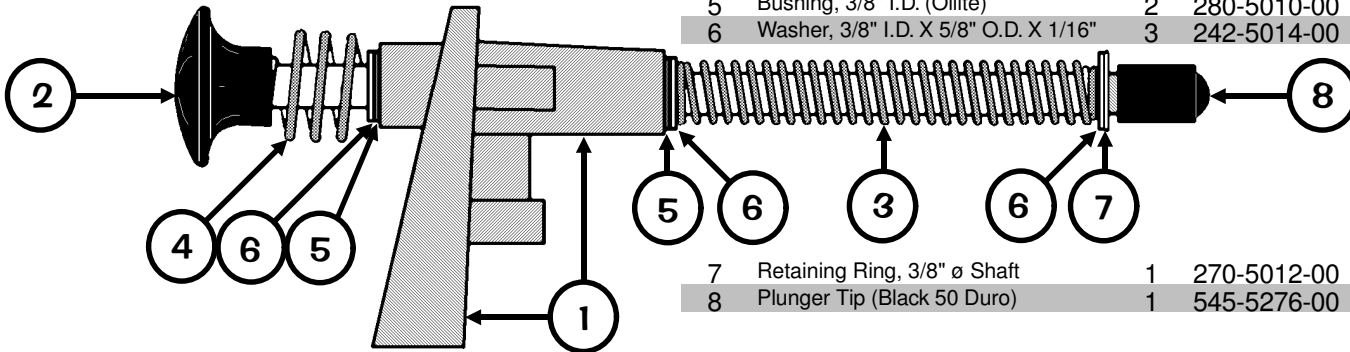

Autoplunger Arm Weld Assembly, 500-6091-00 (Items 1-5)

Automatically launches the ball into play.



Autoplunger Coil Assembly, 500-6092-02 (Items 6-9)

Works in conjunction with the Arm Weld Asm.

Nº	... ARM WELD PART NAME	QTY.	SPI PART Nº	Nº	'PLUNGER COIL PART NAME	QTY.	SPI PART Nº
1	Arm Weld Assembly	1	515-6526-00	6	Autoplunger Coil Bracket Assembly	1	515-6527-00
Item 1 is secured to Item 2 by: Retaining Ring, 1/4" ø Shaft (Qty. 1) (270-5002-00)							
2	Autoplunger Fulcrum	1	535-7697-00	7	Coil Retainer Bracket	1	535-5203-03
3	Nyliner, 1/4" (Thomson #411-FF)	2	545-5423-00	Item 7 is secured to Item 6 by: #8-32 X 1/4" PPH MS (Sems) Zinc (Qty. 2) (232-5300-00)			
4	Plunger & Link Assembly	1	515-5338-00	8	Coil, 24-940	1	090-5036-00B
Item 4 is secured to Item 1 by: Retaining Ring, 1/4" ø Shaft (Qty. 1) (270-5002-00)							
For Individual Items use : Plunger 2" Lg. (530-5025-01), Plunger Link (545-5293-00) and Roll Pin 1/8" ø x 5/8" Lg. (251-5008-00)							
5	Compression (Return) Spring	1	266-5020-00	9	Coil Sleeve	1	545-5031-00
Ordering Note: If either 500-6091-00 or 500-6092-02 are unavailable, order the individual part(s) actually required.							

Take Note:

⊖ **Coil Note:** ⊖ Either -00B or -00T can be used for coil replacements. B/T listed is preferable for easier diode access & may differ on game.

Ordering Note: For Items 1-5 assembled, use the Assembly Part Number, 500-6091-00. For Items 6-9 assembled, use the Assembly PN, 500-6092-02; or order the individual part(s) actually required.

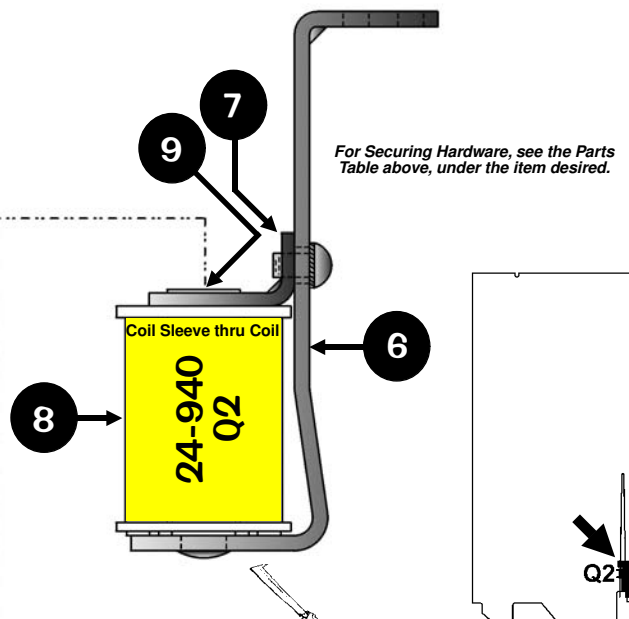
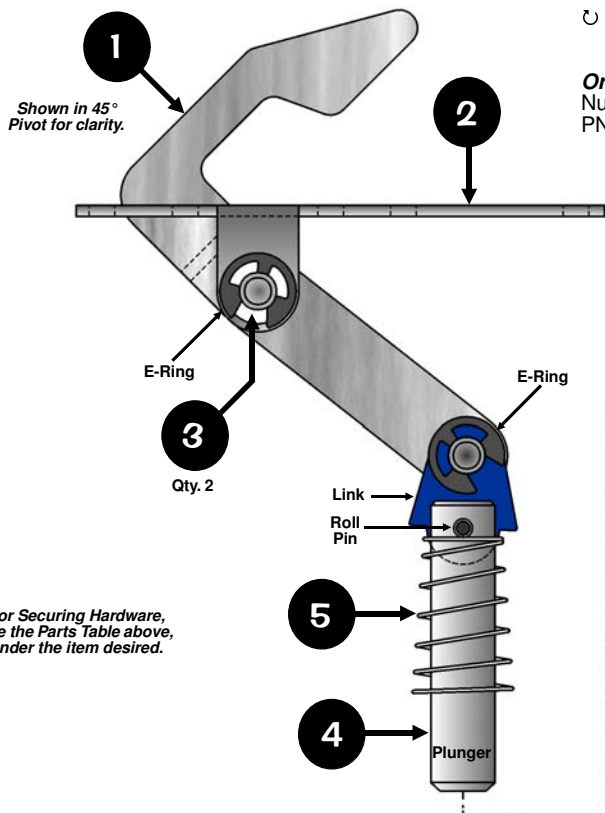

Sec. 4: Drawings ...



4-Ball Trough Assembly, 500-6318-24 (Items 1-13) and Associated Parts: See Parts Table below.

Ordering Note: Identical to 500-6318-14 with exceptions, see note below Item 13 (Parts Table).

Nº	INDIVIDUAL PART NAME	QTY.	SPI PART Nº	Nº	INDIVIDUAL PART NAME	QTY.	SPI PART Nº
1	Ball Trough Outhole Mounting Bracket	1	515-6580-01	11	Trough Ball Guide Plate	1	535-7801-00
Item 1 is secured below the playfield by: #8 X 1/2" HWH AB (Zinc) (Qty. 6) (234-5101-00)				Item 11 is secured to Item 1 by: 1/4" X 5/16" X .144" I.D. Spacer Tap. (Qty. 1) (254-5014-03) and #2-56 X 1/2" HWH (Ser) UNS #4HD TR3 BO (Qty. 4) (237-5937-02)			
2	Micro Switch (Roller Actuator, Lite-Force)	3	180-5119-02	12	Dual OPTO TRANS Board Assembly	1	515-0173-00
Item 2 requires: Heat Shrink Tubing 1/8" ø PUI-24 (Qty. 1"/per) (605-5006-00) Switch has a Diode (1N4004) (112-5003-00). Can be replaced with (1N4001) (112-5001-00).				Items 12 & 13 are by: #6-32 X 5/8" HWH Swage (Serr) Zinc (Qty. 3/per) (237-5976-04) For Individual Items use: Dual OPTO Transmitter Board (Qty. 1) (520-5173-00), Dual OPTO Receiver Board (Qty. 1) (520-5174-00), OPTO PCB Tube Spacer (Brass) (Qty. 3/per) (530-5308-02) and OPTO PCB Rubber Grommet (Qty. 3/per) (545-5518-00)			
3	Sw. Body Protect Plate <i>Not Required</i>	0	535-6539-00	Ordering Note: If 500-6318-24 is unavailable, order the individual part(s) actually required. This assembly is identical to 500-6318-14, -15 or -25 except for the quantity of Item 2 (an additional switch & diode is required for the 5-Ball Trough) and Item 3, Switch Body Protect Plates, are not required when using Item 11 (req. for Magnet use).			
4	Coil Mounting Bracket	1	535-7330-01	ASSOCIATED PARTS ARE NOT INCLUDED WITH THE ABOVE ASSEMBLY.			
Item 4 is secured to Item 1 by: #8-32 X 3/8" HWH Swage (Sr.) Zinc (Qty. 4) (237-5975-00)				Nº ASSOCIATED PART NAME QTY. SPI PART Nº			
5	Coil Retaining Bracket	1	535-5203-03	AP-A	Ball Trough Enter / Exit Scoop	1	535-7329-01
Item 5 is secured to Item 4 by: #8-32 X 1/4" HWH MS (Serr) Zinc (Qty. 2) (237-5964-01)				Item AP-A secured to the playfield by: #8 X 1/2" HWH AB (Zinc) (Qty. 4) (234-5101-00).			
6	Coil, 26-1200	1	090-5044-00B	AP-B*	Steel Balls (1-1/16" ø)	4	260-5000-00
Coil has a Diode (1N4004) (112-5003-00) positioned @ bot (below lugs opposite windings).							
7	Coil Sleeve (Short) (Formost #10-7077)	1	545-5076-01				
8	Plunger Assembly	1	515-5941-01				
For Individual Items use: Plunger (530-5210-00) & Nylon Plunger (530-5277-01)							
9	Compression (Return) Spring	1	266-5020-00				
10	Rubber Bumper (Grommet)	1	545-5105-00				

Take Note:

* An asterisk (*) indicates item(s) are not noted in the pictorials.

⊖ **Coil Note:** ⊖ Either -00B or -00T can be used for coil replacements. B/T listed is preferable for easier diode access & may differ on game.

For a break-down of parts of Items 12 & 13, OPTO Boards (515-0173-00 & 515-0174-00), see Section 5, Chapter 4, Trough Up-Kicker Dual OPTO Boards Theory of Operation & Schematic, Component Layout & Parts.

Take Special Note:

Item AP-A, Enter / Exit Scoop, 535-7329-01 (not included with the 4-Ball Trough Assembly), is shown how it is actually positioned over the 4-Ball Trough Assembly. It is mounted above the playfield.

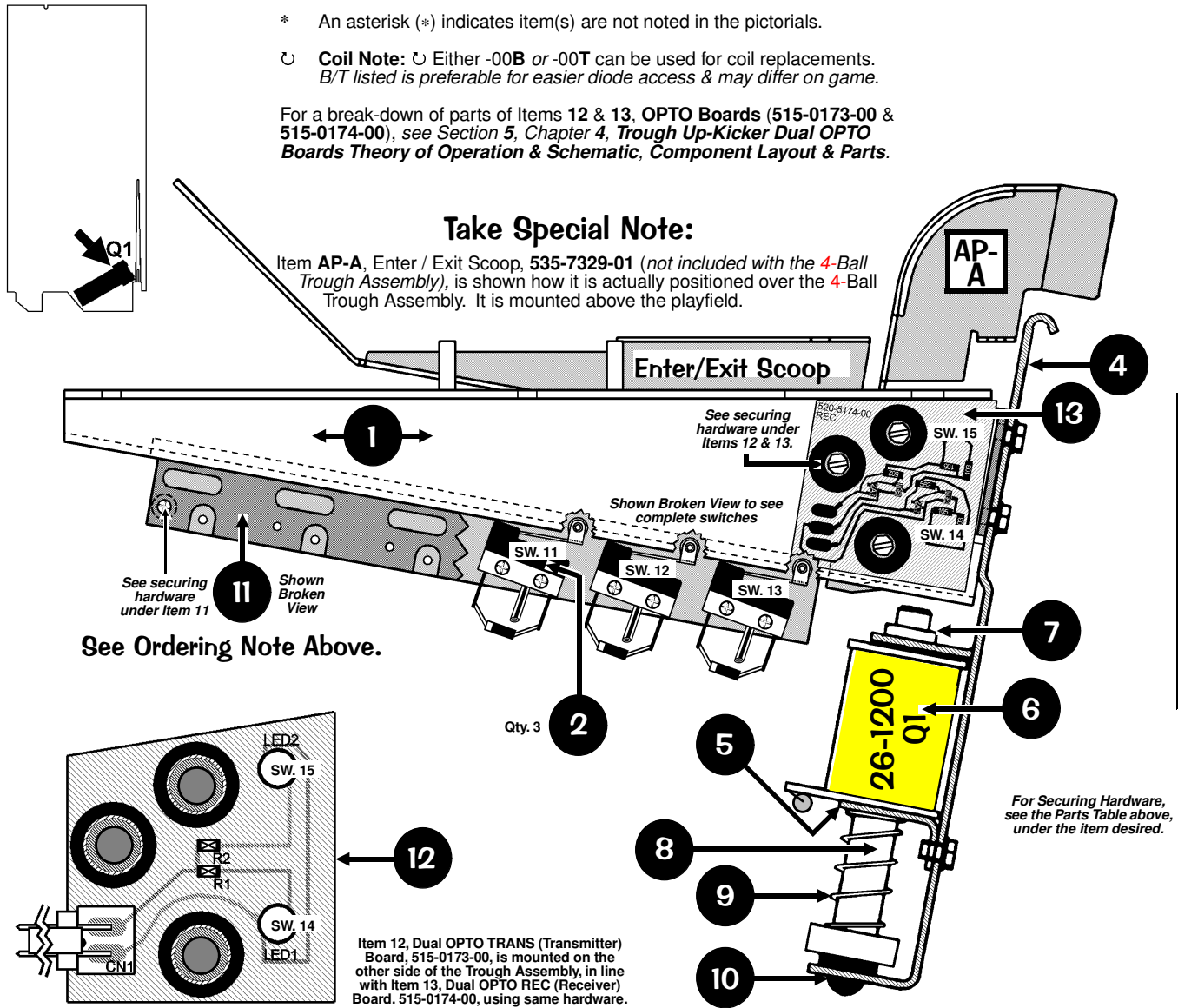

Flipper (Left) Assembly, 500-6543-11 (Items 1-15) and Assoc. Parts: Yellow Flipper Bat & Shaft Assy., 515-5133-06-06 (Item AP-A/-B)



Nº	INDIVIDUAL PART NAME	QTY.	SPI PART Nº	Nº	INDIVIDUAL PART NAME	QTY.	SPI PART Nº
1	Flipper Base Plate (LEFT)	1	See FRP1	13	Crank Bar	1	530-5070-02
Item 1 is secured below the playfield by: #10 X 1/2" HWH MS (Serr) Zinc ST (Qty. 8) (237-5949-00) Ordering Note: Use Item FRP1, see the end of this Parts Table.				Item 13 requires: Bushing, .192" ø ID X .312" ø OD X .195" (Qty. 1) (530-5139-00)			
2	Flipper Bat Bushing (White Plastic)	1	545-5070-00	14	Ⓜ Switch Actuator (LEFT) Sub-Assy.	1	515-7257-01
Item 2 is secured to Item 1 by: #6-32 X 3/8" HWH Swage (Ser.) Zc. (Qty. 3) (237-5976-02)				For Individual Items use : Actuator & Spring Bracket (LEFT) (530-9038-01) and Ⓜ Switch Actuator (White Plastic) (545-5612-00) and is secured to the Bracket by: Rivet, 1/8" ø X 1/4" Lg. (Qty. 1) (249-5003-00)			
3	Power (End of Stroke) Switch	1	180-5149-00	15	Set Screw: #10-32 X 3/4" Socket Hd.	2	237-6144-00
Item 3 is secured to Item 1 by: #6-32 X 5/8" HWH Swage (Ser.) Zc. (Qty. 2) (237-5976-04)				Item 15 requires: #10-32 Nylon Stop Nut (Qty. 1 Flipper Link Side Only) (240-5203-00) Tool Required for Item 15: 5/32" or 4mm Allen Wrench			
4	Sw. Plate/Spring Return Brkt. (LEFT)	1	535-7354-01	Flipper Rebuild Parts for Easier Installation, \$ave \$:			
5	Flipper Return Spring	1	265-5035-00	FRP1 Flipper Base Plate Kit (LEFT)			
6	Coil Stop Bracket Sub-Assembly	1	515-6308-01	Includes Item 1 pre-threaded, with the Securing Hardware for Items 2, 3, 6 & 8.			
Item 6 is secured to Item 1 by: #10-32 X 3/8" SHWH Swage (Serr) Zinc (Qty. 2) (237-5985-00) and #10 Split Lock Washer (Qty. 2) (244-5003-00)				FRP2 Plunger, Link & Crank (LEFT) Assy.			
7	Spring Washer (17/32" ID X 3/4" X 1")	1	269-5002-00	Includes above Items 12, 13, 14 and 15 and is pre-assembled.			
8	Coil Support Bracket	1	535-7356-00	FRP3 Flipper (LEFT) Rebuild Kit			
Item 8 is secured to Item 1 by: #8-32 X 3/8" HWH Swage (Ser.) Zc. (Qty. 2) (237-5975-00)				Same as FRP2, but also includes above Items 6 & 10.			
9	Coil, 22-900 (YEL-YEL) (Left)	1	090-5020-20T	ASSOCIATED PARTS ARE NOT INCLUDED WITH THE ABOVE ASSEMBLY.			
Coil has a Diode (1N4004) (112-5003-00) positioned @ top (above lugs next to windings).				Nº ASSOCIATED PART NAME QTY. SPI PART Nº			
10	Coil Sleeve	1	545-5388-00	AP-A	YELLOW Flipper Bat & Shaft (Plain) (Non-Knurled End) Assembly	1	515-5133-06-06
11	Deflector Pad (Bumper)	1	545-5428-00	AP-B	Large Flipper BLACK Rubber Ring	1	545-5277-00
12	Flipper Plunger & Link Sub-Assy.	1	515-6304-03				
For Individual Items use : Flipper Plunger with "Flat" (530-5349-01) and Plunger "Flipper" Link (545-5611-01) and is secured to the Plunger by: Bushing, .16" ø ID X .281" ø OD X .187" (Qty. 1) (530-5532-00) and Spirol Pin ø 5/32" X 3/4" Lg. (Qty. 1) (251-5015-02)							

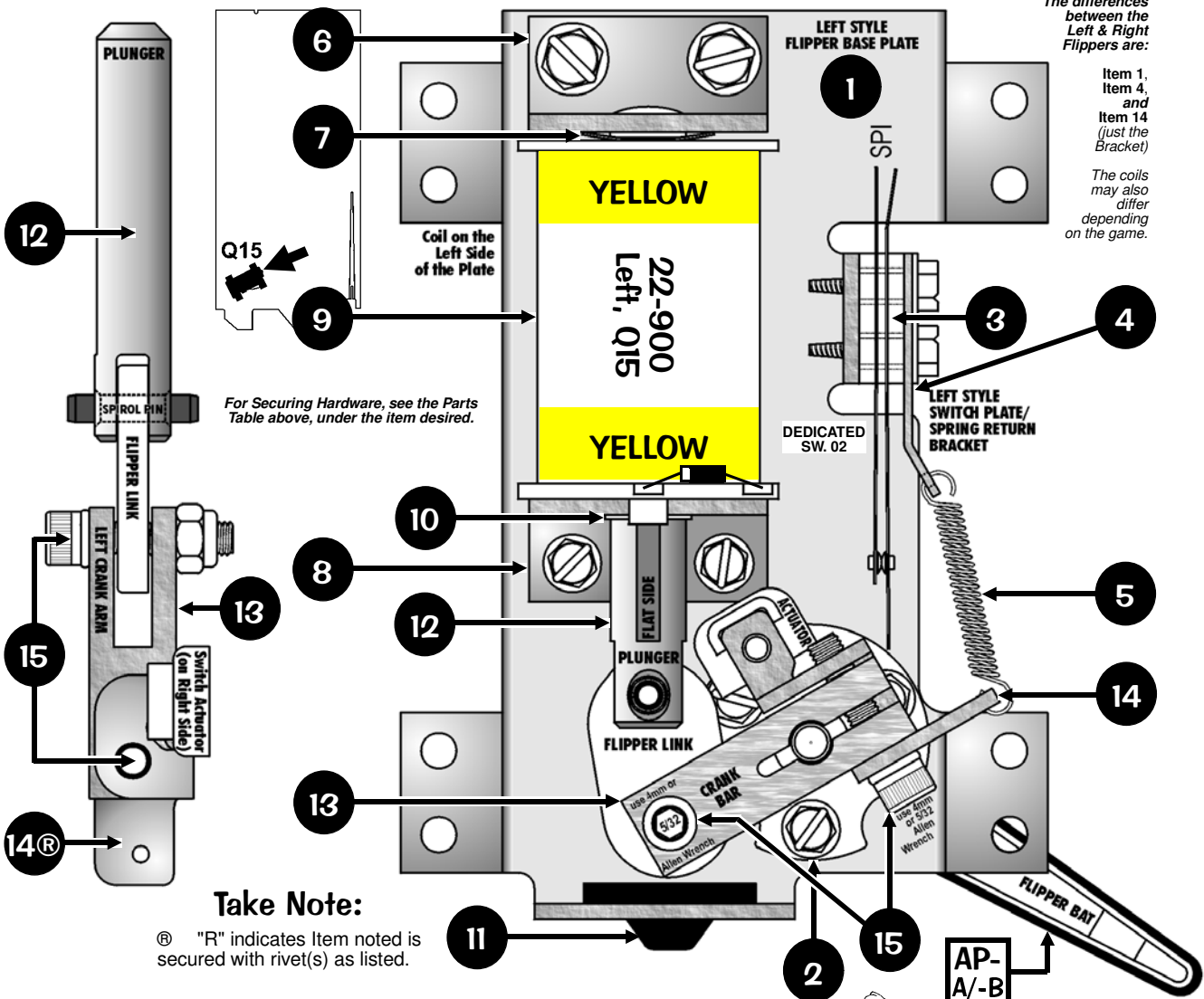

The differences between the Left & Right Flippers are:

Item 1, Item 4, and Item 14 (just the Bracket)

The coils may also differ depending on the game.

For Securing Hardware, see the Parts Table above, under the item desired.

Take Note:

Ⓜ "R" indicates Item noted is secured with rivet(s) as listed.

* To Order the Flipper (Left) Rebuild Kit ask for Part Nr.: 500-6307-10 (includes Items 6, 10, 12, 13, 14 & 15)

Sec. 4: Drawings ...



Flipper (Right) Assembly, 500-6543-01 (Items 1-15) and Assoc. Parts: Yellow Flipper Bat & Shaft Assy., 515-5133-06-06 (Item AP-A/-B)



Nº	INDIVIDUAL PART NAME	QTY.	SPI PART Nº	Nº	INDIVIDUAL PART NAME	QTY.	SPI PART Nº
1	Flipper Base Plate (RIGHT)	1	See FRP1	13	Crank Bar	1	530-5070-02
Item 1 is secured below the playfield by: #10 X 1/2" HWH MS (Serr) Zinc ST (Qty. 8) (237-5949-00) Ordering Note: Use Item FRP1, see the end of this Parts Table.				Item 13 requires: Bushing, .192" ø ID X .312" ø OD X .195" (Qty. 1) (530-5139-00)			
2	Flipper Bat Bushing (White Plastic)	1	545-5070-00	14	Ⓜ Switch Actuator (RIGHT) Sub-Assy.	1	515-7257-00
Item 2 is secured to Item 1 by: #6-32 X 3/8" HWH Swage (Ser.) Zc. (Qty. 3) (237-5976-02)				For Individual Items use : Actuator & Spring Bracket (RIGHT) (530-9038-00) and Ⓜ Switch Actuator (White Plastic) (545-5612-00) and is secured to the Bracket by: Rivet, 1/8" ø X 1/4" Lg. (Qty. 1) (249-5003-00)			
3	Power (End of Stroke) Switch	1	180-5149-00	15	Set Screw: #10-32 X 3/4" Socket Hd.	2	237-6144-00
Item 3 is secured to Item 1 by: #6-32 X 5/8" HWH Swage (Ser.) Zc. (Qty. 2) (237-5976-04)				Item 15 requires: #10-32 Nylon Stop Nut (Qty. 1 Flipper Link Side Only) (240-5203-00) Tool Required for Item 15: 5/32" or 4mm Allen Wrench			
4	Sw. Plate/Spring Return Brkt. (RIGHT)	1	535-7354-00	Flipper Rebuild Parts for Easier Installation, Save \$:			
5	Flipper Return Spring	1	265-5035-00	FRP1	Flipper Base Plate Kit (RIGHT) Includes Item 1 pre-threaded, with the Securing Hardware for Items 2, 3, 6 & 8.		515-6617-00
6*	Coil Stop Bracket Sub-Assembly	1	515-6308-01	FRP2	Plunger, Link & Crank (RIGHT) Assy. Includes above Items 12, 13, 14 and 15 and is pre-assembled.		515-7203-00
Item 6 is secured to Item 1 by: #10-32 X 3/8" SHWH Swage (Serr) Zinc (Qty. 2) (237-5985-00) and #10 Split Lock Washer (Qty. 2) (244-5003-00)				FRP3	Flipper (RIGHT) Rebuild Kit Same as FRP2, but also includes above Items 6 & 10.		500-6307-00
7	Spring Washer (17/32" ID X 3/4" X 1")	1	269-5002-00	ASSOCIATED PARTS ARE NOT INCLUDED WITH THE ABOVE ASSEMBLY.			
8	Coil Support Bracket	1	535-7356-00	Nº	ASSOCIATED PART NAME	QTY.	SPI PART Nº
Item 8 is secured to Item 1 by: #8-32 X 3/8" HWH Swage (Ser.) Zc. (Qty. 2) (237-5975-00)				AP-A	YELLOW Flipper Bat & Shaft (Plain) (Non-Knurled End) Assembly	1	515-5133-06-06
9	Coil, 22-900 (YEL-YEL) (Right)	1	090-5020-20T	AP-B	Large Flipper BLACK Rubber Ring	1	545-5277-00
Coil has a Diode (1N4004) (112-5003-00) positioned @ top (above lugs next to windings).							
10	Coil Sleeve	1	545-5388-00				
11	Deflector Pad (Bumper)	1	545-5428-00				
12	Flipper Plunger & Link Sub-Assy.	1	515-6304-03				
For Individual Items use : Flipper Plunger with "Flat" (530-5349-01) and Plunger "Flipper" Link (545-5611-01) and is secured to the Plunger by: Bushing, .16" ø ID X .281" ø OD X .187" (Qty. 1) (530-5532-00) and Spirol Pin ø 5/32" X 3/4" Lg. (Qty. 1) (251-5015-02)							

* To Order the Flipper (Right) Rebuild Kit ask for Part Nr.: 500-6307-00 (includes Items 6, 10, 12, 13, 14 & 15)

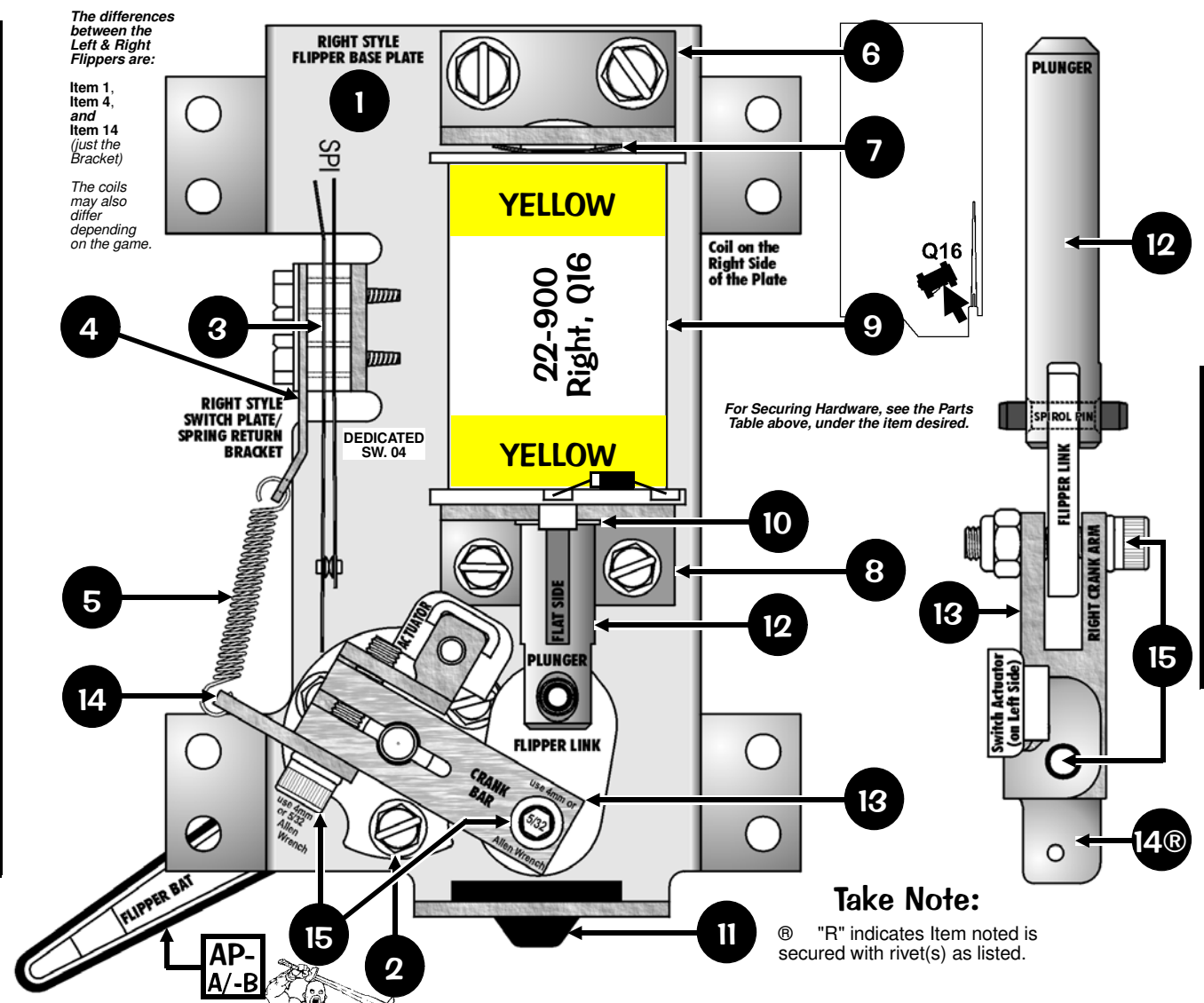

Sec. 4: Drawings ...

Drawings for Major Assemblies & Ramps



Diverter (3-Legged Flipper, Left) Assembly, 500-6543-32-80 (Items 1-15) and Associated Part: Diverter Gate & Shaft Assembly, 515-7348-00 (Item AP-A)

Nº	INDIVIDUAL PART NAME	QTY.	SPI PART Nº	Nº	INDIVIDUAL PART NAME	QTY.	SPI PART Nº		
1	Diverter Base Plate (Lt. 3-Legged)	1	See FRP1-80	13	Crank Bar	1	530-5070-02		
Item 1 is secured below the playfield by: #10 X 1/2" HWH MS (Serr) Zinc ST (Qty. 8) (237-5949-00) Ordering Note: Use Item FRP1-80, see the end of this Parts Table.				Item 13 requires: Bushing, .192" ø ID X .312" ø OD X .195" (Qty. 1) (530-5139-00)					
2	Flipper Bat Bushing (White Plastic)	1	545-5070-00	14	® Switch Actuator (LEFT) Sub-Assy.	1	515-7257-01		
Item 2 is secured to Item 1 by: #6-32 X 3/8" HWH Swage (Ser.) Zc. (Qty. 3) (237-5976-02)				For Individual Items use : Actuator & Spring Bracket (LEFT) (530-9038-01) and ® Switch Actuator (White Plastic) (545-5612-00) and is secured to the Bracket by: Rivet, 1/8" ø X 1/4" Lg. (Qty. 1) (249-5003-00)					
3	1/4" X 3/8" Spacer Gray	2	254-5000-02	15	Set Screw: #10-32 X 3/4" Socket Hd.	2	237-6144-00		
Item 3 is secured to Item 1 by: #6-32 X 5/8" HWH Sw. (Ser.) Zc. (Qty. 1/per) (237-5976-04)				Item 15 requires: #10-32 Nylon Stop Nut (Qty. 1 Flipper Link Side Only) (240-5203-00) Tool Required for Item 15: 5/32" or 4mm Allen Wrench					
4	Sw. Plate/Spring Return Brkt. (LEFT)	1	535-7354-01	Flipper Rebuild Parts for Easier Installation, Save \$:					
5	Flipper Return Spring	1	265-5035-00	Flipper Base Plate Kit (Left, 3-Legged)					
6	Coil Stop Bracket Sub-Assembly	1	515-6308-01	FRP1-80	Includes Item 1 (Modified: 1-Leg Cut-Off, 535-7275-01-80) pre-threaded, with the Securing Hardware for Items 2, 3, 6 & 8.		515-6617-01-80		
Item 6 is secured to Item 1 by: #10-32 X 3/8" SHWH Swage (Serr) Zinc (Qty. 2) (237-5985-00) and #10 Split Lock Washer (Qty. 2) (244-5003-00)				FRP2				Includes above Items 12, 13, 14 and 15 and is pre-assembled.	515-7203-01
7	Spring Washer (17/32" ID X 3/4" X 1")	1	269-5002-00	FRP3				Flipper (LEFT) Rebuild Kit Same as FRP2, but also includes above Items 6 & 10.	500-6307-10
8	Coil Support Bracket	1	535-7356-00	ASSEMBLY PART IS NOT INCLUDED WITH THE ABOVE ASSEMBLY.					
Item 8 is secured to Item 1 by: #8-32 X 3/8" HWH Swage (Ser.) Zc. (Qty. 2) (237-5975-00)				Nº ASSOCIATED PART NAME				QTY.	SPI PART Nº
9	Coil, 22-1080 (YEL-GRN)	1	090-5032-00T	AP-A	Diverter Gate & Shaft Assembly	1	515-7348-00		
Coil has a Diode (1N4004) (112-5003-00) positioned @ top (above lugs next to windings).									
10	Coil Sleeve	1	545-5388-00						
11	Deflector Pad (Bumper)	1	545-5428-00						
12	Flipper Plunger & Link Sub-Assy.	1	515-6304-03						
For Individual Items use : Flipper Plunger with "Flat" (530-5349-01) and Plunger "Flipper" Link (545-5611-01) and is secured to the Plunger by: Bushing, .16" ø ID X .281" ø OD X .187" (Qty. 1) (530-5532-00) and Spirol Pin ø 5/32" X 3/4" Lg. (Qty. 1) (251-5015-02)									

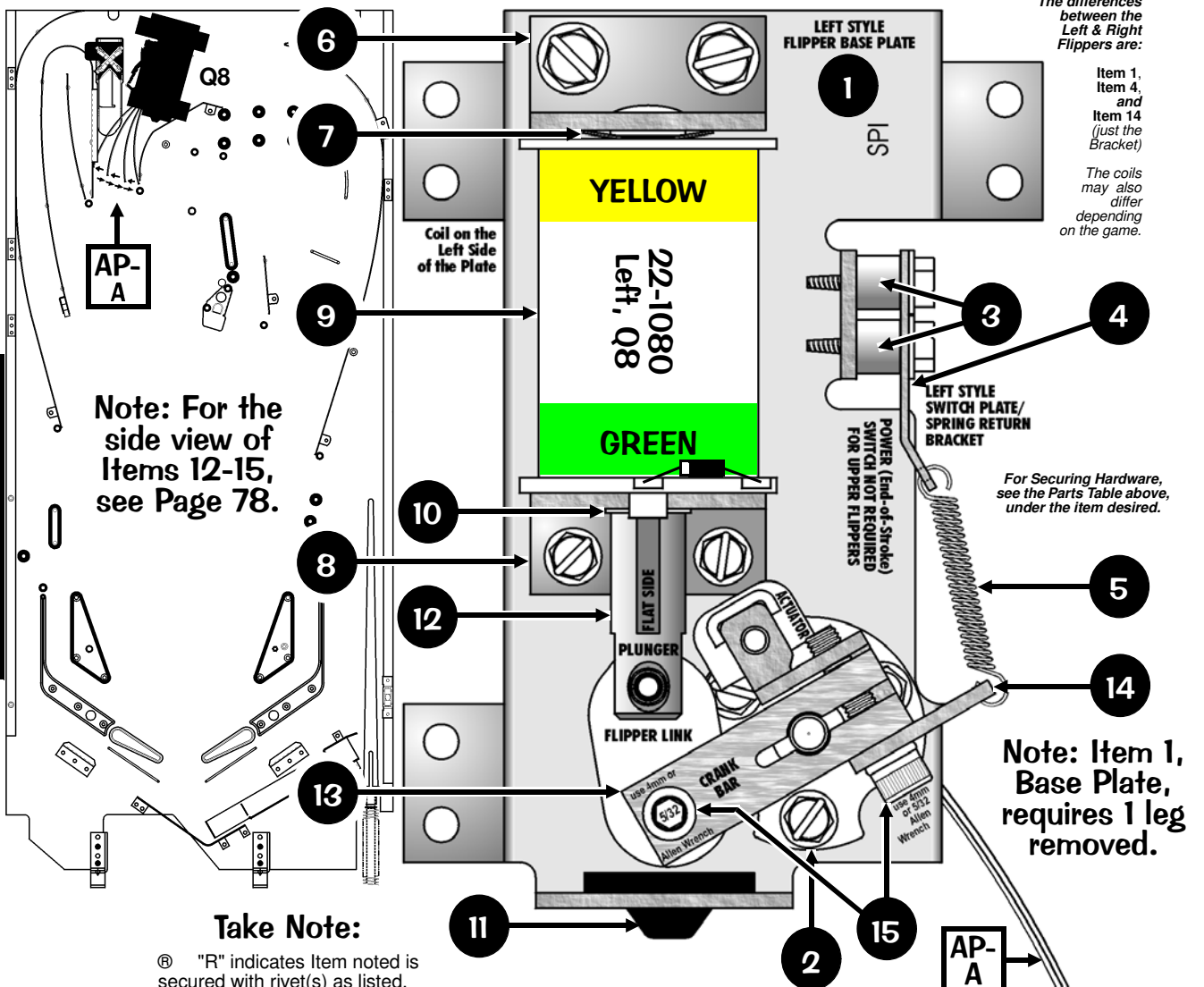

* To Order the Flipper (Left) Rebuild Kit ask for Part Nr.: 500-6307-10 (includes Items 6, 10, 12, 13, 14 & 15)

Sec. 4: Drawings ...

Diverter Gate Adjustment Procedure

This adjustment procedure is important. Unlike adjusting your flipper bats, adjusting the gate is done opposite. With the **Power Turned OFF** and the *Playfield raised, at rest against the Backbox*, perform the following:

Step 1: Under the Playfield, using a 5/32" Allen Wrench, loosen the Set-Screw on the Crank Bar *just enough so that the Diverter Paddle can move with a gentle amount of force*. **Reference Fig. 1-A.**

Step 2: Above the Playfield, position the Diverter Paddle to the Right Side Flat Rail so they touch (*opening the gate to the Left Orthanc Tower*). **Ref. Fig. 2.** With your finger, hold the gate in this position until Step 3 is performed.

Step 3: Under the Playfield, push the Diverter Coil Plunger into the Coil Sleeve. **Reference Fig. 1-B.** With your finger, continue holding in the plunger and release the Diverter Gate (**Fig. 2**) to perform *Step 4*. If the Gate moves, refer to *Step 1* and retighten just enough to hold in position (**Fig. 2**).

Step 4: Tighten the Set-Screw on the Crank Bar. **Reference Fig. 1-A.**

Step 5: Check above the playfield to ensure the Diverter Paddle Gate in the "Rest Position" is as close to the Left Flat Rail as possible without touching it. **Reference Fig. 3.**

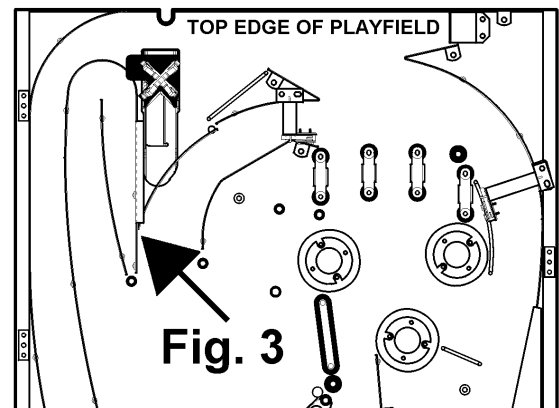
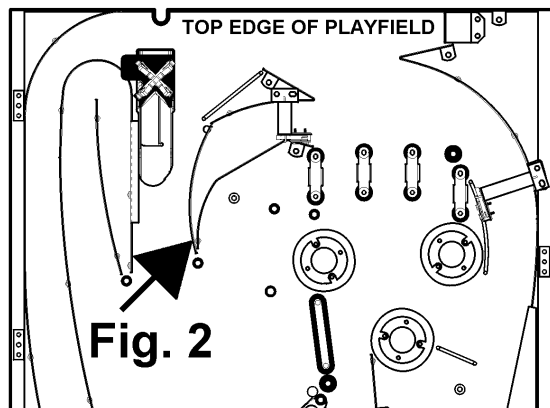
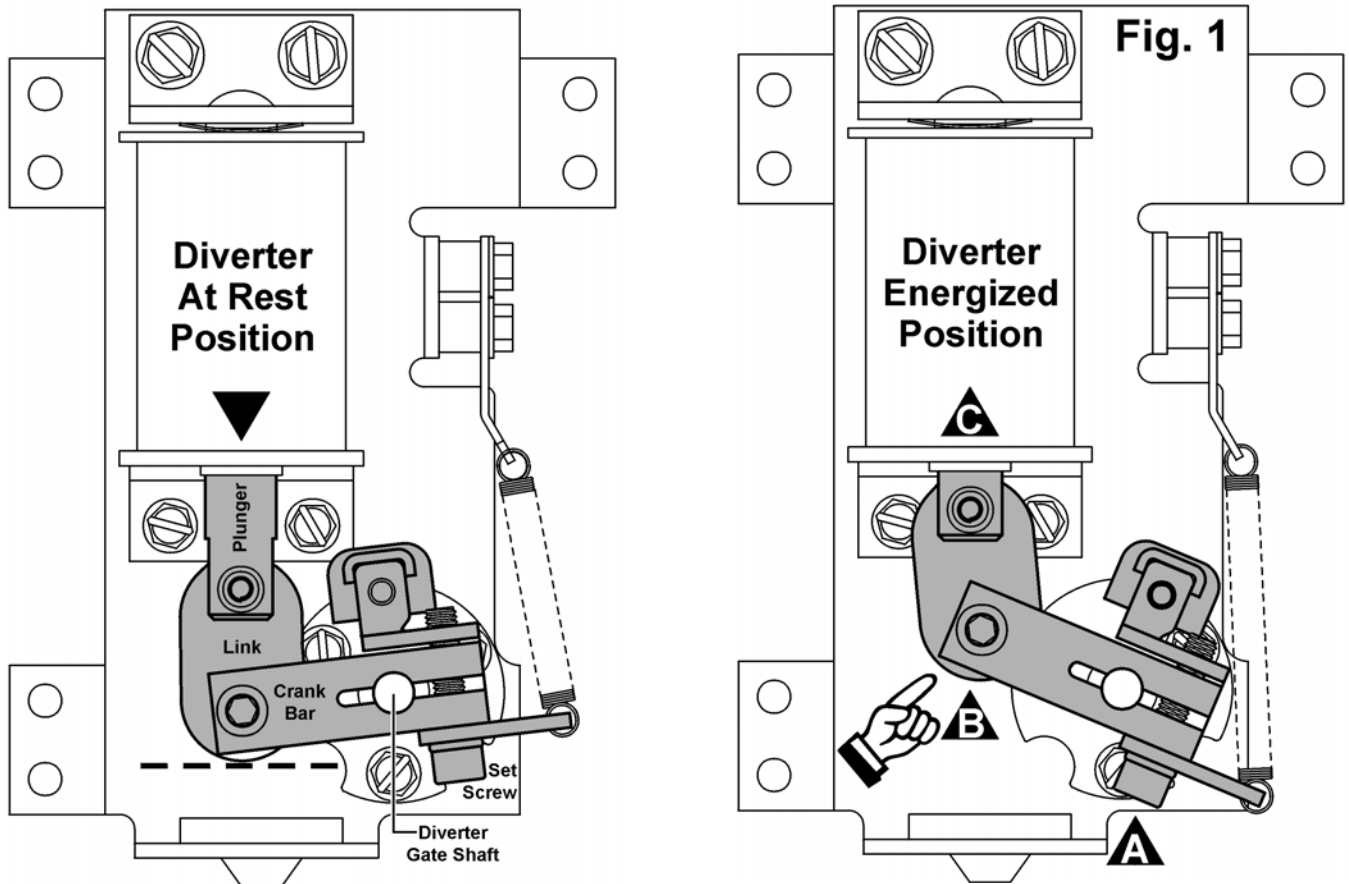

Ball Deflector Assembly (Upper Left Orbit), 500-6657-03 (Items 1-7)

When energized, it deflects the pinball into the Orthanc Tower VUK (Page 88).

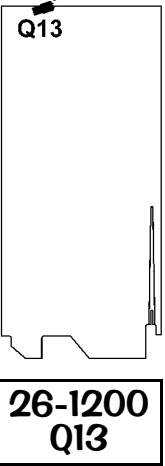

Nº	INDIVIDUAL PART NAME	QTY.	SPI PART Nº
1	Ball Deflector Coil Mounting Bracket	1	535-9248-00
Item 1 is secured below the playfield by: #8 X 1/2" PRH AB (Zinc) (Qty. 3) (237-5101-00)			
2	Coil Retaining Bracket	2	535-5203-03
Item 2 is secured by: #8-32 X 1/4" PPH MS (Sems) Zinc (Qty. 2/per) (232-5300-00)			
3	Coil, 26-1200	1	090-5044-00B
Coil has a Diode (1N4004) (112-5003-00) positioned @ bot (below lugs opposite windings).			
4	Coil Sleeve (with Extension)	1	545-5847-00
5	Plunger (with Rubber Bumper) Assy.	1	515-7089-01
For Individual Items use : Plunger (530-5210-00) and Plunger Tip (530-5559-01). The Plunger Tip is secured to the Plunger by: Roll Pin 1/8" ø x 3/8" Lg. (Qty. 1) (251-5007-04)			
6	Compression (Relay) Spring	1	266-5022-01
7	#10-32 Adj. Spindle Stop w/Rubber Tip	1	280-5014-00
Item 7 is secured by: #10-32 Keps Nut (Qty. 1) (240-5208-00)			
Ordering Note: If 500-6657-03 is unavailable, order the individual part(s) actually required.			

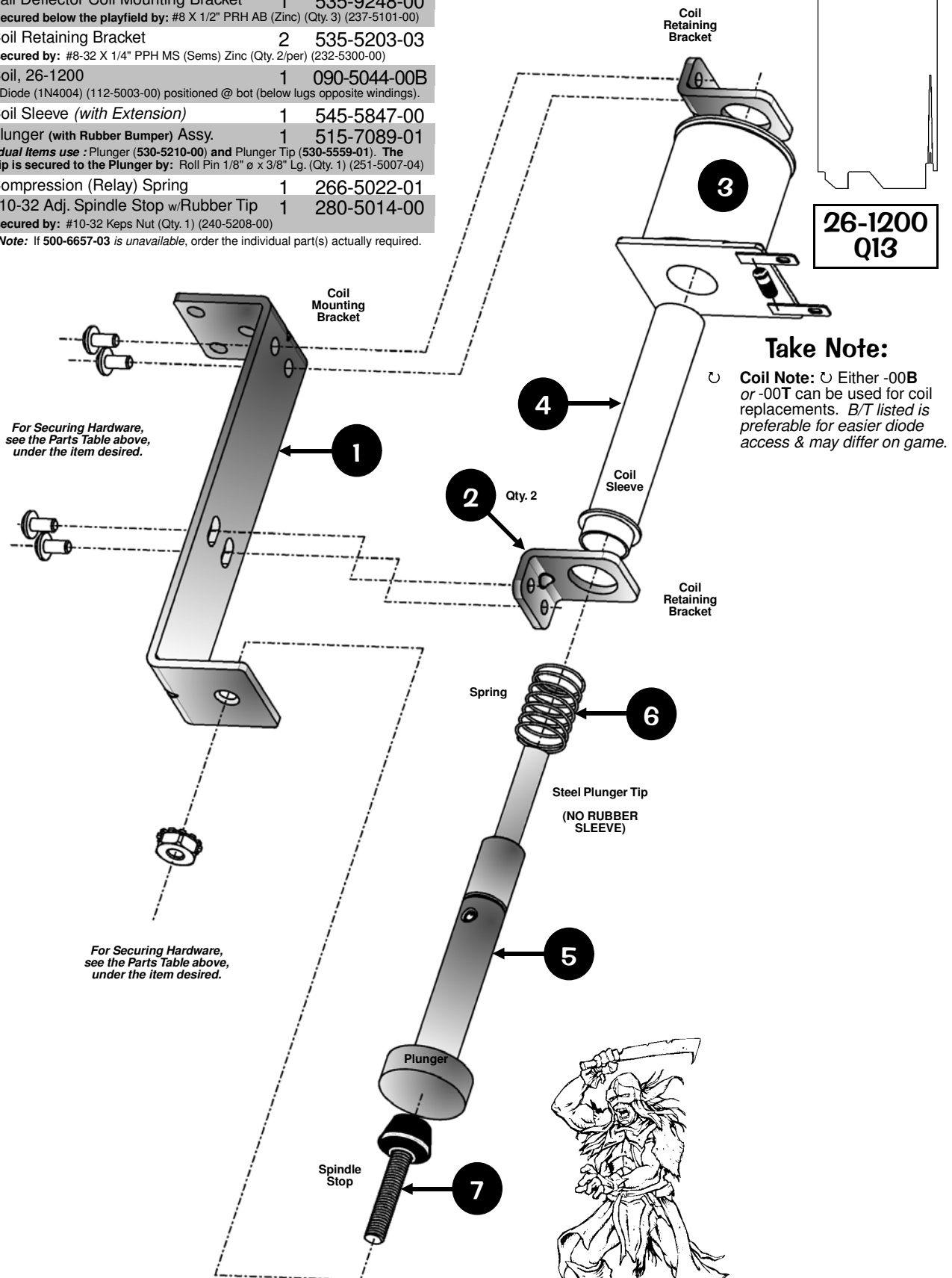

For Securing Hardware, see the Parts Table above, under the item desired.

For Securing Hardware, see the Parts Table above, under the item desired.

Sec. 4: Drawings ...



**Bumper Top Assemblies, 515-6459-08 (Qty. 3) (Items 1-5),
Bumper Bottom Assy., 515-6459-04 (Qty. 3) (Items 6-13),
Bumper Switch Assy., 515-6459-03 (Qty. 3) (Items 14-17)
and Associated Parts: See Parts Table below.**

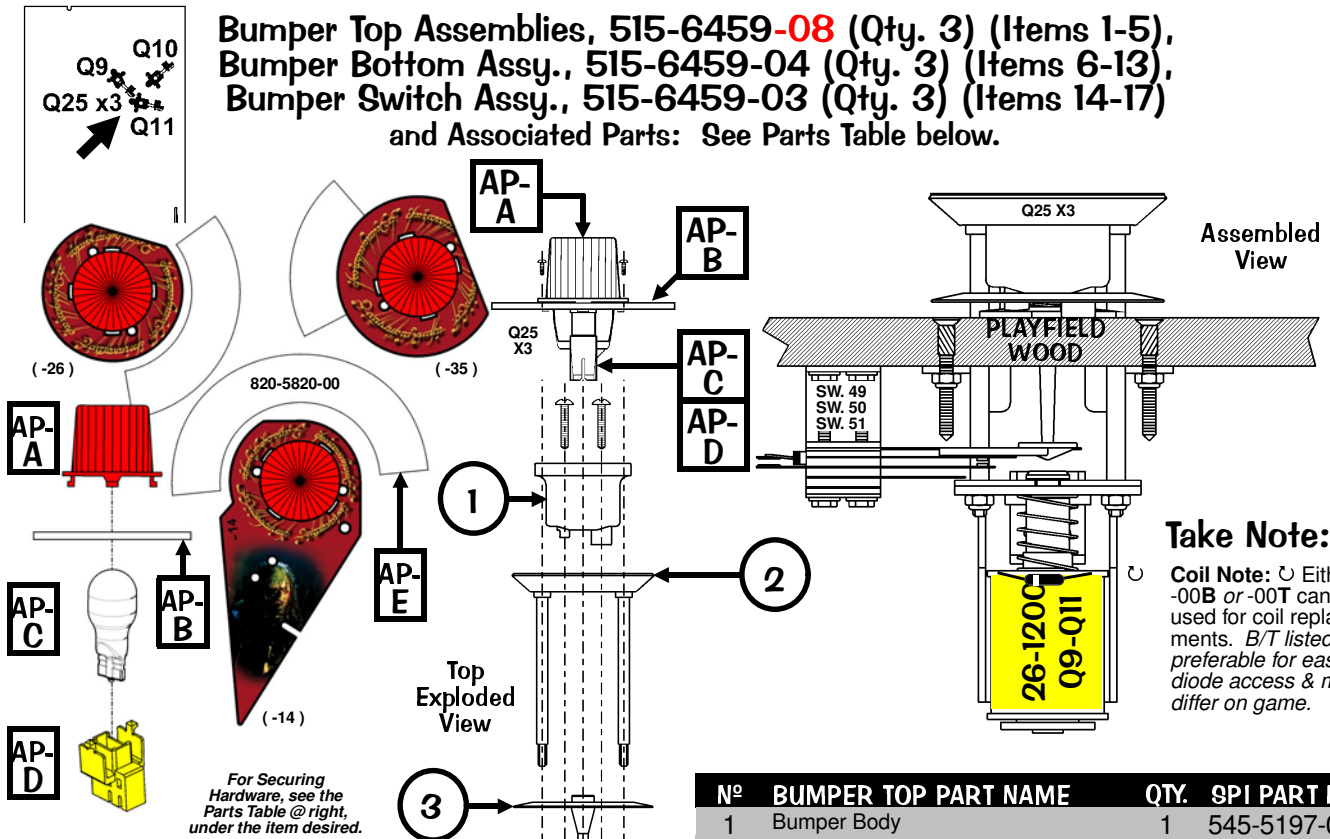

Take Note:
Individual parts can be ordered.
However, if the entire Bumper is required,
use all three (3) Assembly Part Numbers
at the top of this page.

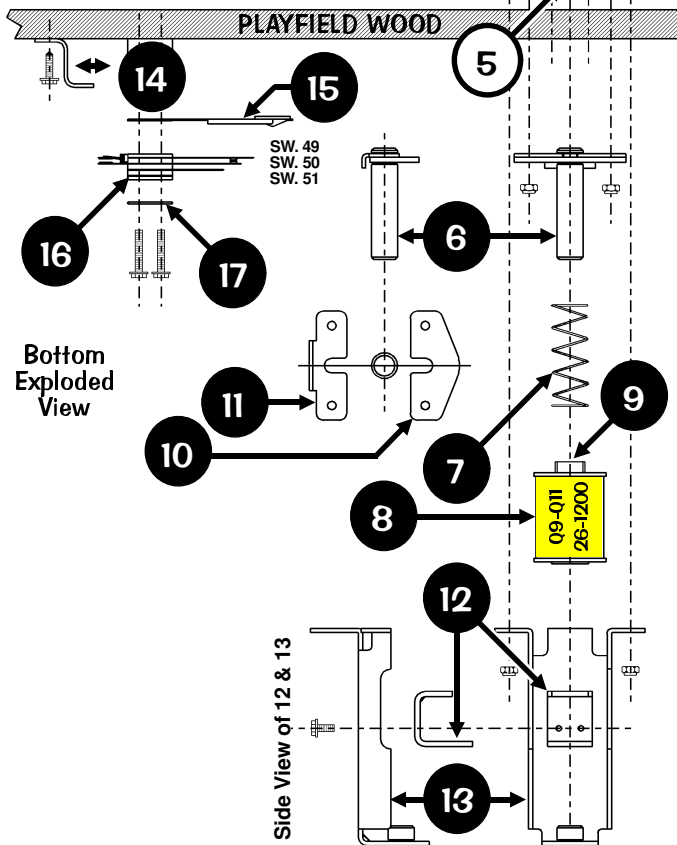

Drawings for Major
Assemblies & Ramps

Nº	BUMPER TOP PART NAME	QTY.	SPI PART Nº
1	Bumper Body	1	545-5197-00
Item 1 is secured by: #5 X 7/8" PRH AB (Zinc) (Qty. 2) (237-5826-00)			
2	Ring Assembly	1	515-5085-00
Item 2 is secured by: #6-32 Nylon Stop Nut (Qty. 2) (240-5005-00)			
3	Bumper Skirt	1	545-5607-00
4	Bumper Skirt Compression Spring	1	266-5048-00
5	Bumper Base	1	545-5195-00

Nº	BUMPER BOTTOM PART NAME	QTY.	SPI PART Nº
6	Plunger	1	530-5348-00
7	Compression (Return) Spring	1	266-5047-00
8	Coil, 26-1200	1	090-5044-00T
Coil has a Diode (1N4004) (112-5003-00) positioned @ top (above lugs next to windings).			
9	Coil Sleeve	1	545-5031-00
10	Fiber Yoke	1	545-5609-00
11	Metal Yoke	1	535-7346-00
12	Metal Yoke Stop	1	535-7347-00
Item 12 is secured by: #6-32 X 1/4" HWH Swage (Serr.) Zinc (Qty. 2) (237-5976-01)			
13	Coil Bracket Welded Assembly	1	515-5939-00
Item 13 is secured by: #6-32 X 1-3/16" Spiral Fin Shank (Qty. 3) (237-5957-00) and #6-32 Nylon Stop Nut (Qty. 3) (240-5005-00)			

Nº	BUMPER SWITCH PART NAME	QTY.	SPI PART Nº
14	Switch Bracket	1	535-7342-00
Item 14 is secured by: #8 X 1/2" HWH AB (Zinc) (Qty. 2) (234-5101-00)			
15	Spoon Switch Actuator	1	545-5610-01
16	Bumper Stack (Blade) Switch	1	180-5015-03
Switch has a Diode (1N4004) (112-5003-00). Can be replaced with (1N4001) (112-5001-00).			
17	Switch Body Protect Plate	1	535-7344-00
Items 16 & 17 are secured by: #6-32 X 3/4" HWH Swage (Serr.) Zc. (Qty. 2) (237-5976-05)			
The Top & Bottom Assemblies are secured together by hardware included in assemblies.			

ASSOCIATED PARTS ARE NOT INCLUDED WITH THE ABOVE ASSEMBLIES.

Nº	ASSOCIATED PART NAME	QTY.	SPI PART Nº
AP-A	Mini-Mars Lite Cover (Snap-In) Red	3	550-5030-02
AP-B	Kit: Plastics (Screened) -14, -26 & -35	1	803-5000-80
Item AP-B are secured to Item 2 by: #4-40 X 3/8" PFH (Black) (Qty. 2/per) (237-5983-00) Note: Individual Plastics (-14, -26 & -35) are not available individually, ordering of kit is required. For all pieces, see Playfield - Plastics (Screened & Clear) & Decals, Page 67.			
AP-C	#906 Wedge Base Bulb (Clear)	3	165-5004-00
AP-D	IDC Snap-On Socket (Yel.) No Diode	3	077-5216-00
AP-E	P/F Bumper Protectors (trim to fit)	3	820-5820-00

Slingshot Assemblies, 500-5849-00 (Qty. 2) (Items 1-9)

Nº	INDIVIDUAL PART NAME	QTY.	SPI PART Nº
1	Slingshot Bracket Assembly	1	515-5339-01
Item 1 is secured below the playfield by: #8 X 1/2" HWH AB (Zinc) (Qty. 3) (234-5101-00)			
2	Coil Retaining Bracket	1	535-5203-03
Item 2 is secured to Item 1 by: #8-32 X 3/8" PPH MS (Sems) (Qty. 2) (232-5301-00)			
3	Coil, 23-800	1	090-5001-00T
Coil has a Diode (1N4004) (112-5003-00) positioned @ top (above lugs next to windings).			
4	Coil Sleeve	1	545-5031-00
5	Plunger & Link Assembly	1	515-5338-00
For Individual Items use : Plunger 2" Lg. (530-5025-01), Plunger Link (545-5293-00) and Roll Pin 1/8" ø x 5/8" Lg. (251-5008-00) The Plunger Link is secured to the Riveted Arm by: Retaining Ring, 1/4" ø Shaft (Qty. 1) (270-5002-00)			
Ordering Note: If 515-5338-00 is unavailable, order the individual part(s) actually required.			
6	Compression (Return) Spring	1	266-5020-00
7	Slingshot Stack (Blade) Switch	2	180-5054-00
Switch has a Diode (1N4004) (112-5003-00). Can be replaced with (1N4001) (112-5001-00).			
8	Switch Body Protect Plate	2	535-5045-00
Items 7 & 8 are secured to Item 1 by: #6-32 X 5/8" HWH Swage (Qty. 4) (237-5976-04)			
9®	Riveted Arm & Tip Assembly	1	515-5340-01
For Individual Parts use (requires drilling out rivet & re-securing) : Arm (515-5341-01), Kicker Tip (545-5216-01) and Rivet, 1/8" ø x 1/4" Lg. (249-5003-00) The Riv. Arm is secured to Item 1 by: Retaining Ring, 1/4" ø Shaft (Qty. 1) (270-5002-00)			
Ordering Note: If 515-5340-01 is unavailable, order the individual part(s) actually required.			
Ordering Note: If 500-5849-00 is unavailable, order the individual part(s) actually required.			

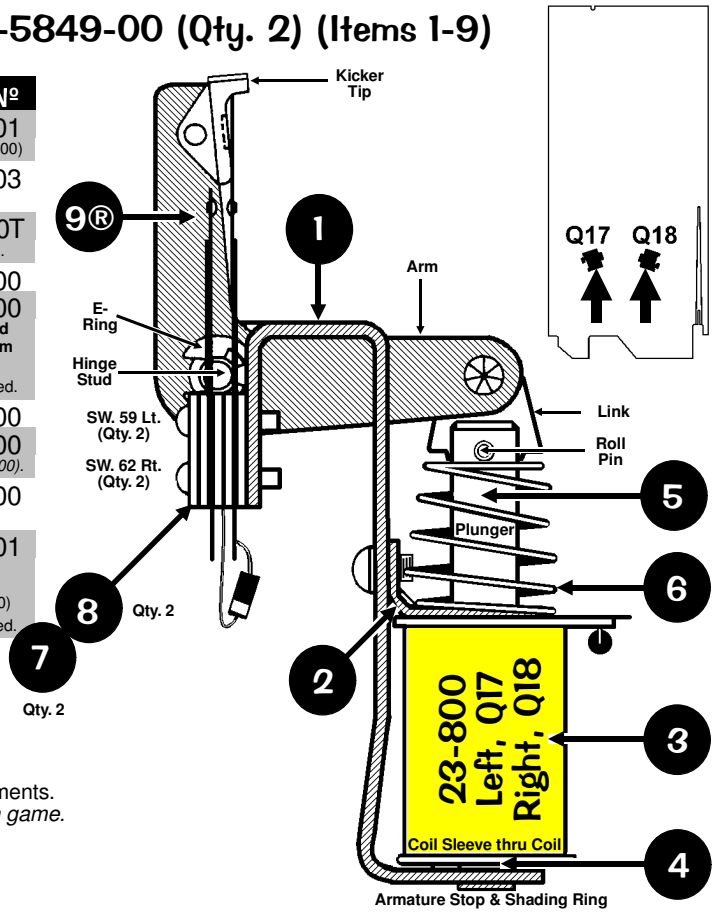

Take Note:

- ⊖ **Coil Note:** ⊖ Either -00B or -00T can be used for coil replacements. B/T listed is preferable for easier diode access & may differ on game.
- ® "R" indicates Item noted is secured with rivet(s) as listed.

VUK (Vertical Up-Kicker, Left Style) Assembly, 500-6696-00 (Items 1-10)

Launches ball onto the Center Wire Ramp (Page 92) and exits the Sword Ramp (Page 93).

Nº	INDIVIDUAL PART NAME	QTY.	SPI PART Nº
1	VUK Coil Mounting Bracket (Left Style)	1	535-8296-00
Item 1 is secured under the playfield by: #8 X 1/2" HWH AB (Zinc) (Qty. 5) (234-5101-00)			
2	Micro Sw. (Heavy Duty "Y" Flat Actuator)	1	180-5116-01
3	Switch Body Protect Plate	1	535-6539-00
Items 2-3 are secured by: #2-56 X 1/2" HWH MS (Serr) Zc TF 3/16" (Qty. 2) (237-5937-02)			
4	Coil Retaining Bracket	1	535-5203-03
Item 4 is secured by: #8-32 X 1/4" PPH MS (Sems) Zinc (Qty. 2) (232-5300-00)			
5	Coil, 26-1200 (Note Lug Position)	1	090-5044-00B
Coil has a Diode (1N4004) (112-5003-00) positioned @ bot (below lugs opposite windings).			
6	Coil Sleeve (Short) (Formost #10-7077)	1	545-5076-01
7	Spring Washer, 17/32" ID X 3/4" X 1"	1	269-5002-00
8	Plunger Assembly	1	515-5941-01
For Individual Items use : Plunger (530-5210-00) & Nylon Plunger (530-5277-01)			
9	Compression (Relay) Spring	1	266-5020-00
10	Rubber Bumper (Grommet)	1	545-5105-00
Ordering Note: If 500-6696-00 is unavailable, order the individual part(s) actually required.			

This assembly is identical to 500-6290-00 except for the coil, lug & diode position.
If replacing, note position of coil before removing.

Take Note:

DOTS: The Switch Diode, 1N4001, is not located on either VUK Assembly (nor included); it's located on a Terminal Strip under the playfield near this assembly. See Section 5, Chapter 2, Playfield Terminal Strips., Page 105, for more details.

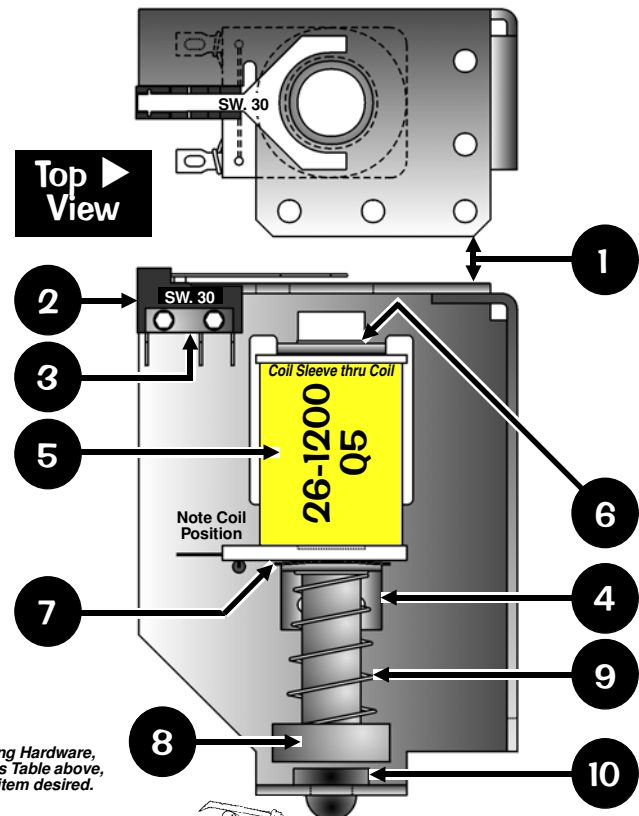
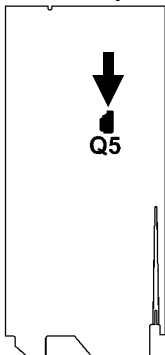

For Securing Hardware, see the Parts Table above, under the item desired.



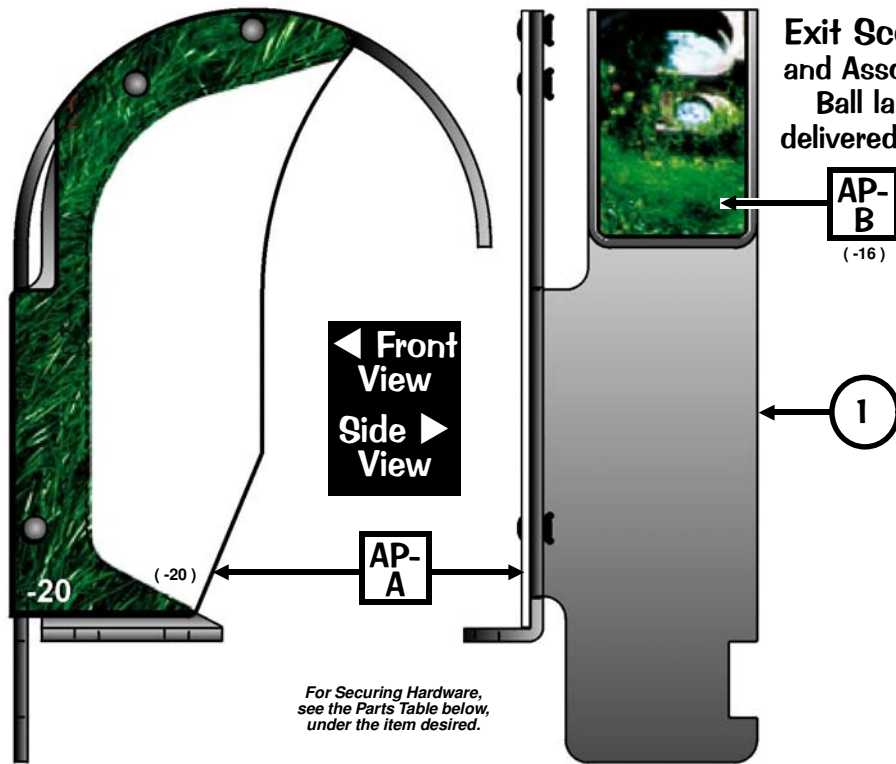

Exit Scoop, 535-9287-00 (Item 1) and Assoc. Parts: See Parts Table below.
Ball launches from below VUK and is delivered to the Left Wire Ramp (Pg. 92).

Nº	INDIVIDUAL PART NAME	QTY.	SPI PART Nº	Nº	ASSOCIATED PART NAME	QTY.	SPI PART Nº
1	Exit Scoop	1	535-9287-00	AP-A	Kit: Decals (Screened) -16	1	802-5000-80
Item 1 is secured below the playfield by: #8-32 X 1" PPH MS (Zinc) (Qty. 2) (237-5606-00) and #8-32 Nylon Stop Nut (Qty. 2) (240-5102-00)				AP-B	Kit: Plastics (Screened) -20	1	803-5000-80
				Item AP-B is secured to Item 1 by: Pop Rivet, 1/8" ø X 3/16" Lg. (Qty. 1, bot) (249-5025-01) and Rivet, 1/8" ø X 1/4" Lg. (Black) (Qty. 2, top) (249-5003-01)			

Note: Individual Plastic (-20) & Decal (-16) are not available individually, ordering of kit is required. For all pieces, see Playfield - Plastics (Screened & Clear) & Decals, Page 67.

VUK (Vertical Up-Kicker, Right Style) Assembly, 500-6696-01 (Items 1-10) Launches ball into the above Exit Scoop onto the Left Wire Ramp (Page 92).

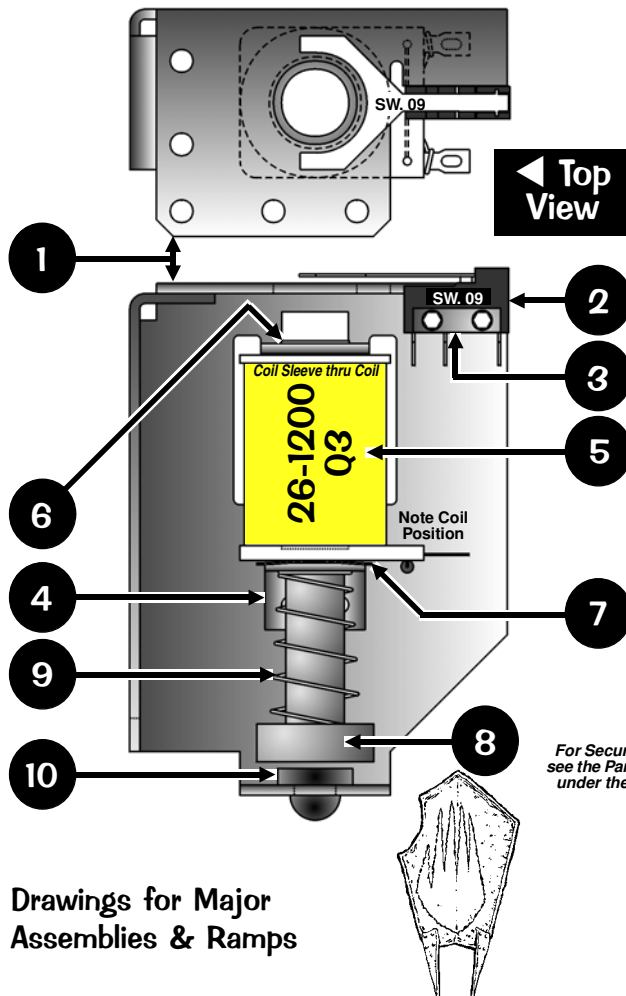

Nº	INDIVIDUAL PART NAME	QTY.	SPI PART Nº
1	VUK Coil Mounting Bracket (Right Style)	1	535-8296-01
Item 1 is secured under the playfield by: #8 X 1/2" HWH AB (Zinc) (Qty. 3) (234-5101-00)			
2	Micro Sw. (Heavy Duty "Y" Flat Actuator)	1	180-5116-01
3	Switch Body Protect Plate	1	535-6539-00
Items 2-3 are secured by: #2-56 X 1/2" HWH MS (Serr) Zc TF 3/16" (Qty. 2) (237-5937-02)			
4	Coil Retaining Bracket	1	535-5203-03
Item 4 is secured by: #8-32 X 1/4" PPH MS (Sems) Zinc (Qty. 2) (232-5300-00)			
5	Coil, 26-1200 (Note Lug Position)	1	090-5044-00B
Coil has a Diode (1N4004) (112-5003-00) positioned @ bot (below lugs opposite windings).			
6	Coil Sleeve (Short) (Formost #10-7077)	1	545-5076-01
7	Spring Washer, 17/32" ID X 3/4" X 1"	1	269-5002-00
8	Plunger Assembly	1	515-5941-01
For Individual Items use : Plunger (530-5210-00) & Nylon Plunger (530-5277-01)			
9	Compression (Relay) Spring	1	266-5020-00
10	Rubber Bumper (Grommet)	1	545-5105-00

Ordering Note: If 500-6696-01 is unavailable, order the individual part(s) actually required.

This assembly is identical to 500-6290-01 except for the coil, lug & diode position.

If replacing, note position of coil before removing.

Take Note:

DOTS: The Switch Diode, 1N4001, is not located on either VUK Assembly (nor included); it's located on a Terminal Strip under the playfield near this assembly. See Section 5, Chapter 2, Playfield Terminal Strips... Page 105, for more details.

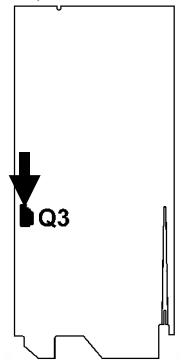

Drawings for Major Assemblies & Ramps

Sec. 4: Drawings ...

Balrog (Motor & Gate) Individual Parts Only (Items 1-26)

Parts Table (next page) for views on this and the next page.

Works in conjunction with the Balrog Switch Gate (above the playfield) shown next page.

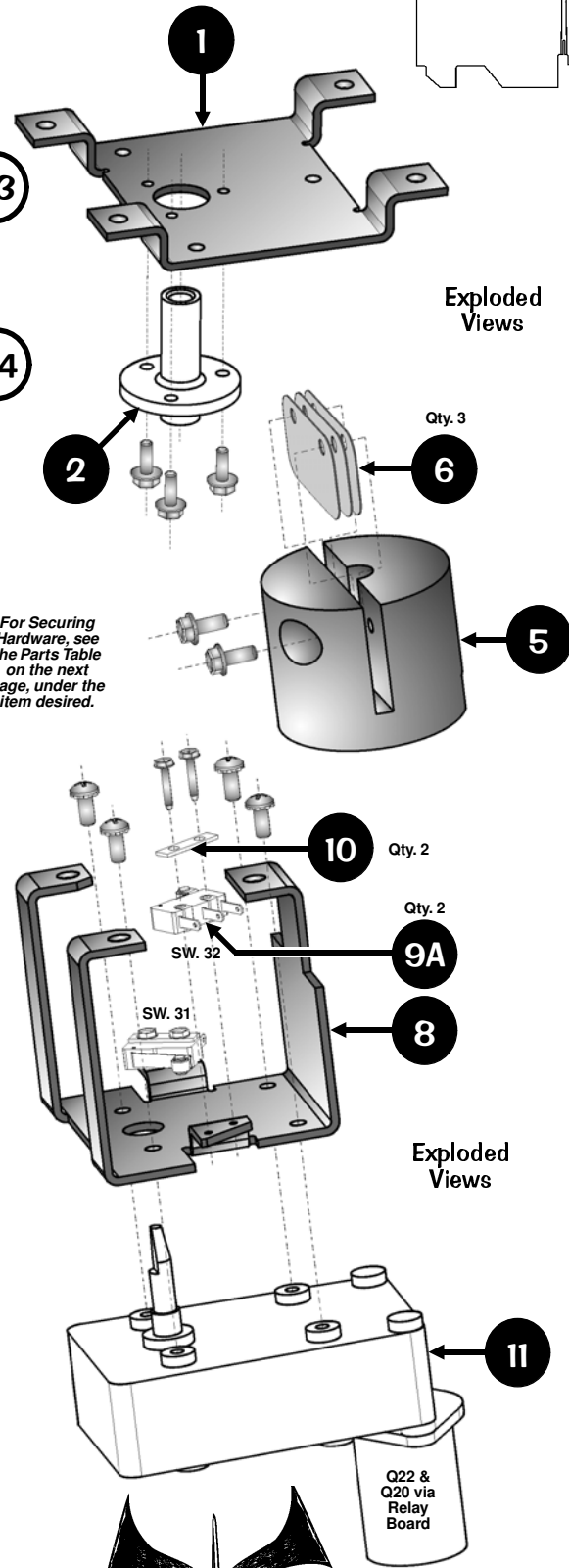
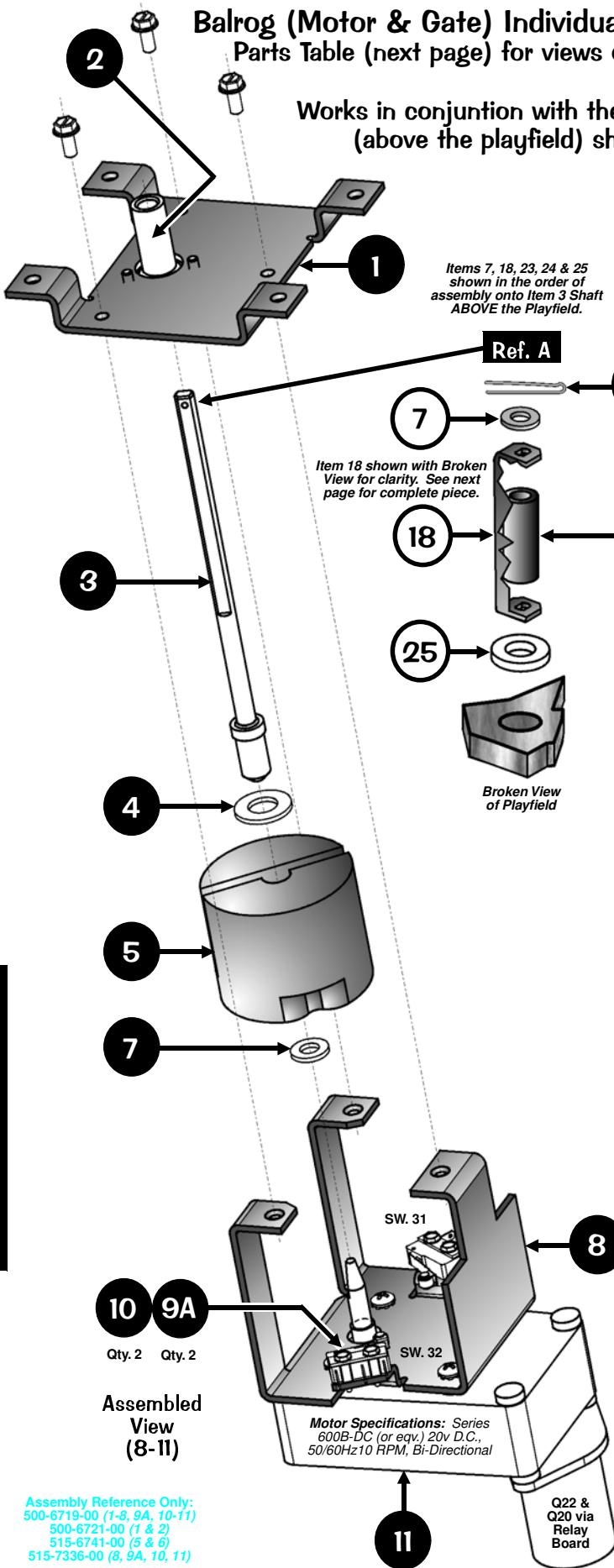
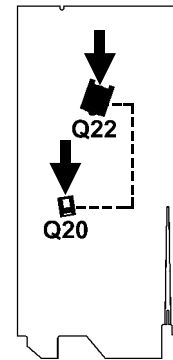

Assembled View (8-11)

Assembly Reference Only:
 500-6719-00 (1-8, 9A, 10-11)
 500-6721-00 (1 & 2)
 515-6741-00 (5 & 6)
 515-7336-00 (8, 9A, 10, 11)

Sec. 4: Drawings ...



Balrog (Motor & Gate) (Items 1-26) Continued

Parts Table below for views on this & prev. page.

Nº	INDIVIDUAL PART NAME	QTY.	SPI PART Nº
1	Motor Mounting Plate Bracket	1	535-9347-01
Item 1 is secured below the playfield by: #10 X 1/2" HWH (Sr.) Zc. (Qty. 4) (237-5949-00) and is secured to Item 8 by: #8-32 X 3/8" HWH Swage (Qty. 3) (237-5975-00)			
2	Bushing (Flipper Type) (White Plastic)	1	545-5070-00
Item 2 is secured to Item 1 by: #6-32 X 3/8" HWH Swage (Ser.) Zc. (Qty. 3) (237-5976-02)			
3	Drive Shaft	1	530-5650-00
See previous page for Ref. A (Item 18) with assembly order of Items 7, 23, 24 & 25.			
4	Washer (Steel) .39" ID X .75" OD X .063" Thick	1	242-5049-00
5	Coupling-Interrupter	1	530-5649-00
6	Clutch (Spring) Plate	3	535-8764-00
Item 6 is secured to Item 5 by: #8-32 X 3/8" HWH MS Type C (Qty. 2) (237-5903-00)			
7	Washer (Steel) 1/4" ID X 1/2" OD X 1/16" Thick	2	242-5008-00
8	Motor Mounting Bracket	1	535-9346-01
Item 8 is secured to Item 11 by: #8-32 X 3/8" PPH MS (Sems) Zinc (Qty. 4) (232-5301-00)			
9A	Micro Switch (Roller Actuator, Lite Force)	2	180-5119-02
9B	Micro Switch (Roller Actuator)	1	180-5119-00
Switch has a Diode (1N4004) (112-5003-00). Can be replaced with (1N4001) (112-5001-00).			
10	Switch Body Protect Plate	3	535-6539-00
Items 9 & 10 are secured to Item 8 by: #2-56 X 1/2" HWH (Sr.) (Qty. 2/per) (237-5937-02)			
11	Multi Products Motor 20V DC	1	041-5088-01
12	Balrog (Molded Plastic)	1	545-5083-00
Item 12 is secured to Item 13 by: #6-32 X 3/4" PPH MS (Sems) Zc. (Qty. 2) (232-5204-00) and #6 Washer (Qty. 2) (242-5001-00)			
13	Balrog Mounting Bracket	1	535-9348-00
14	Spring Retainer Bracket	1	535-9391-00
Items 14 & 16 are secured to Item 12 through 13 by: Identical Hardware as Item 6.			
15	Compression Spring (Heavy Duty)	1	266-5076-00
16a	2-Lug Laydown Std. Bayonet Socket	1	077-5100-00
17a	#89 Bulb (Bayonet, Clear)	1	165-5000-89
16b	2-Lug Laydown Bayonet Socket, Modified	1	077-5003-00-80
17b	LED (Red) Module Bayonet 12.8v 20-25mA	1	112-5023-02
18	Balrog Gate Welded Bracket	1	515-7333-00
Item 18 is secured to Item 13 by: #6-32 X 1/4" PPH MS (Zinc) (Qty. 2) (237-5516-00), #6 Washer (Qty. 2) (242-5001-00) and #6-32 Nylon Stop Nut (Qty. 1/per) (240-5005-00)			
19	Switch Mounting Bracket	1	535-7948-01
Item 19 is secured to Item 18 by: #6-32 X 1/4" HWH Swg. (Sr.) Zinc (Qty. 2) (237-5976-01)			
20	Balrog Protector Bracket	1	535-9398-00
Item 20 is secured to Item 18 by: #6-32 X 1/4" PPH MS (Sems) Zc. (Qty. 2) (232-5200-00)			
21	1-1/16" 1-Groove Plastic Post (Black)	2	550-5059-00
Item 21 is secured to Item 18 by: #6-32 X 1/2" PFH (Qty. 1/per) (237-5510-01), #6 Washer (Qty. 1/per @ top) (242-5001-00) and Item 26 (Qty. 1/per @ top).			
22	Black Rubber Ring, 3/16" I.D.	2	545-5348-01
23	Cotter Pin, 1/16" ø X 1/2" Lg. (Zinc)	1	251-5006-00
24	Bumper BLACK (Rubber Post Sleeve, Tall)	1	545-5308-00
25	Washer (Nylon) .32" X .75" X .13"	1	242-5078-00
26	Hex Spacer, 1 1/8" X 1/4" #6-32 Tap (...ends)	2	254-5008-17

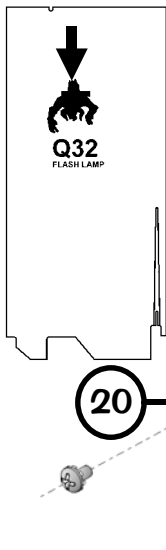
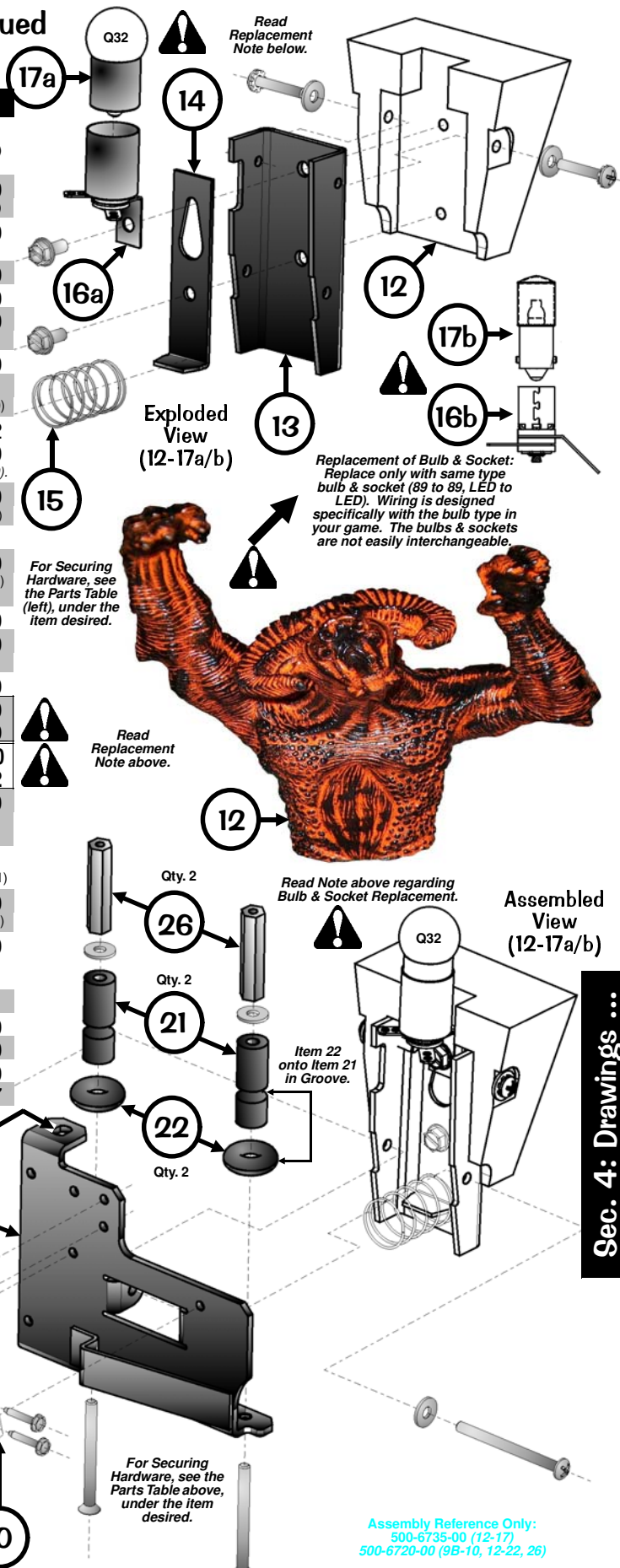

Ref. A
See previous page for the assembly order of Items 7, 18, 23, 24 & 25 onto Item 3, Shaft, ABOVE the Playfield.

Drawings for Major Assemblies & Ramps



Orthanc Tower, Up-Kicker and Ball Trough (Up-Kicker Tray) Individual Parts Only, (Items 1-13)

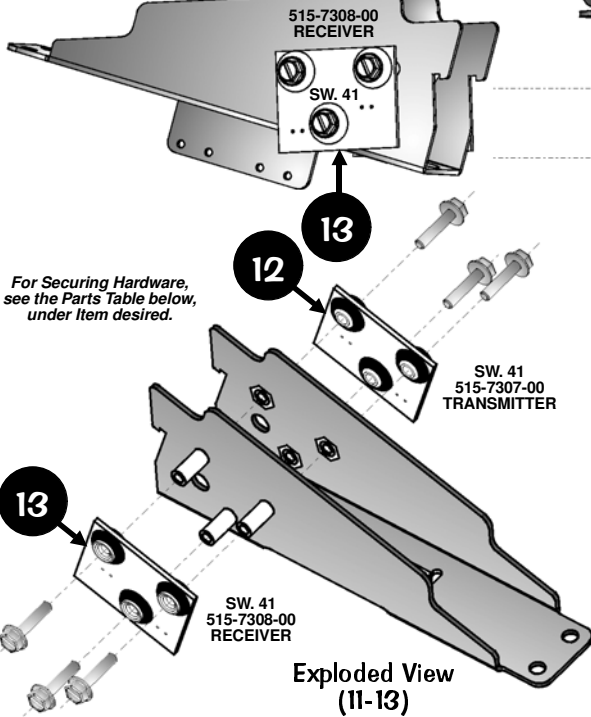
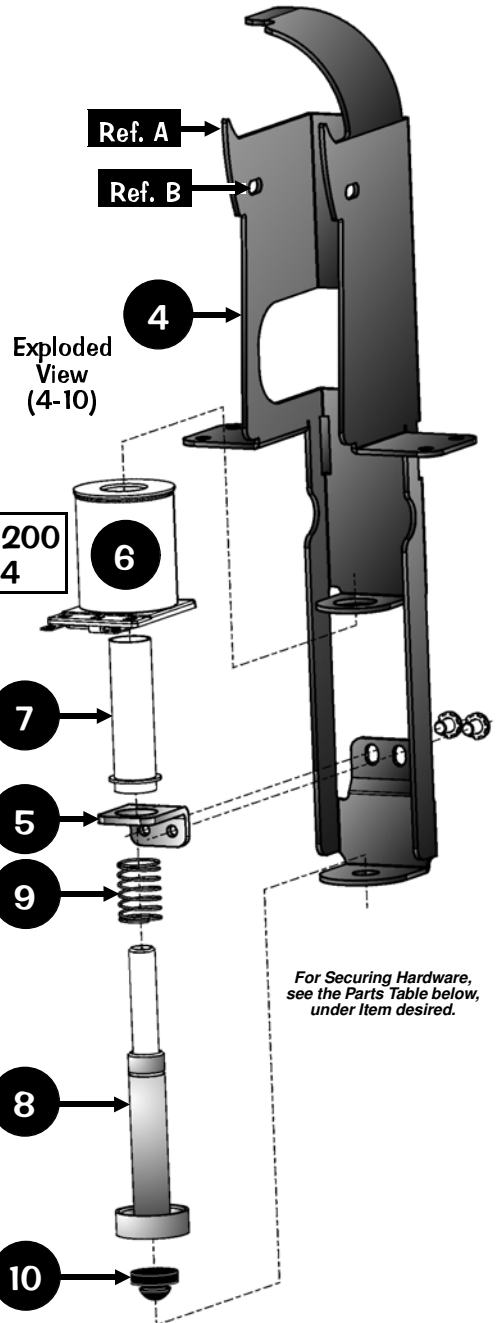
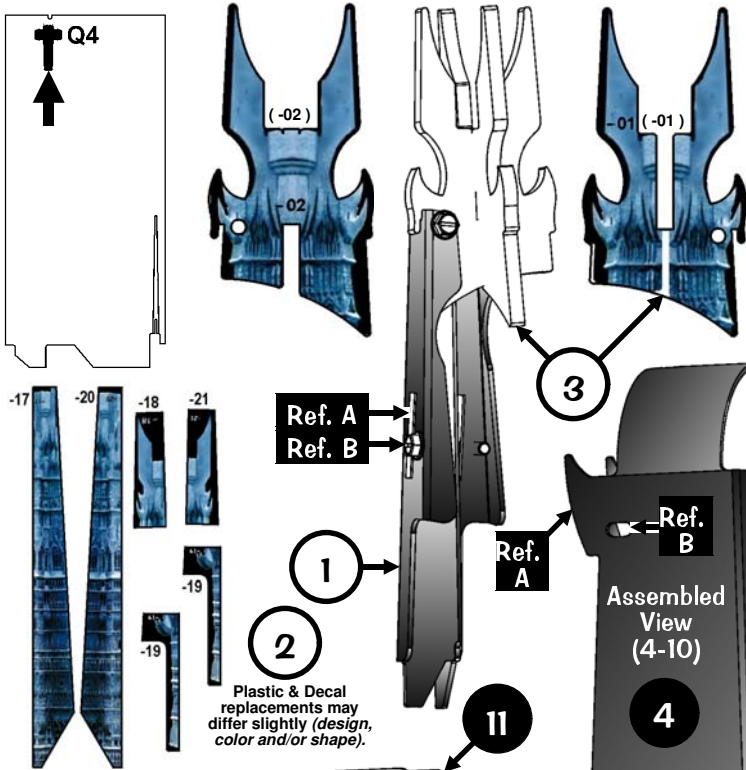

For Securing Hardware, see the Parts Table below, under Item desired.

For Securing Hardware, see the Parts Table below, under Item desired.

Assembly Reference Only:
500-6722-00 (1-13)
515-7335-00 (4-10)
515-7334-00 (11-13)

Sec. 4: Drawings ...

Nº	INDIVIDUAL PART NAME	QTY.	SPI PART Nº	Nº	INDIVIDUAL PART NAME	QTY.	SPI PART Nº
1	Orthanc Tower	1	535-9351-00	7	Coil Sleeve (Short) (Formost #10-7077)	1	545-5076-01
Item 1 is secured by slot holes (Ref. A) onto Item 4 and by (Ref. B): #8-32 X 3/8" HWH MS Type C (Qty. 2) (237-5903-00)				8	Plunger Assembly	1	515-5941-00
2	Kit: Decals (Screened) -17 thru -21	1	802-5000-80	For Individual Items use : Plunger (530-5210-00) & Nylon Plunger (530-5277-01)			
3	Kit: Thick Plastics (Screened) -01, -02	1	803-5001-80	9	Compression (Relay) Spring	1	266-5022-01
Item 3 is secured to Item 1 by: #8-32 X 3/8" HWH MS Type C (Qty. 1/per) (237-5903-00) Note: Individual Decals (-17, -18, -19 [x2], -20 & -21) and Thick Plastics (-01 & -02) are not available individually, ordering of kit is required. For all pieces, see Playfield - Plastics (Screened & Clear) & Decals, Page 67.				10	Rubber Bumper (Grommet)	1	545-5105-00
4	Up-Kicker (Frame) Coil Mntg. Bracket	1	535-9350-00	11	Ball Trough (Up-Kicker Tray) Bracket	1	535-9349-00
Item 4 is secured below the playfield by: #8 X 1/2" PRH AB (Zinc) (Qty. 4) (237-5101-00)				Item 11 is secured below the playfield by: #8 X 1/2" HWH AB (Zc.) (Qty. 2) (234-5101-00)			
5	Coil Retaining Bracket	1	535-5203-03	12	Single OPTO TRANS Bd. Assembly	1	515-7307-00
Item 5 is secured by: #8-32 X 1/4" PPH MS (Sems) Zinc (Qty. 2/per) (232-5300-00)				13	Single OPTO REC Board Assembly	1	515-7308-00
6	Coil, 26-1200	1	090-5044-00B	Items 12 & 13 are secured by: #6-32 X 5/8" HWH Swg. (Sr.) Zc. (Qty. 3/per) (237-5976-04) For Individual Items use : Single OPTO Transmitter Board (Qty. 1) (520-5230-00), Single OPTO Receiver Board (Qty. 1) (520-5231-00), OPTO PCB Tube Spacer (Brass) (Qty. 3/per) (530-5308-02) and OPTO PCB Rubber Grommet (Qty. 3/per) (545-5518-00)			
Coil has a Diode (1N4004) (112-5003-00) positioned @ bot (below lugs opposite windings).							



Barad-dûr Tilting Tower Individual Parts Only, (Items 1-10)

Nº	INDIVIDUAL PART NAME	QTY.	SPI PART Nº	Nº	INDIVIDUAL PART NAME	QTY.	SPI PART Nº
1	Barad-dûr Tower	1	545-5082-00	3	Bracket, Top (Tilt Mech.)	1	535-9365-00
Item 1 is secured to Item 2 (@ top) by: Washer, .17" ID X .5" OD X .042" Thick (Qty. 1) (242-5015-00) and #6-32 Nylon Stop Nut (Qty. 1) (240-5005-00)				Item 3 is secured to Item 4 by: #6-32 X 2" PPH MS (Zinc) (Qty. 1) (237-5513-00), Washer (White Teflon), .15" ID X .312" OD X .05" Thick (Qty. 2, 1 each outside bracket) (242-5079-00) and #6-32 Nylon Stop Nut (Qty. 1) (240-5005-00)			
2	Clevis (Tilt Mech. Brkt.) w/Pem Stud	1	515-7346-00	4	Tilt Mech. Coil Mounting Bracket	1	535-9364-00
Item 2 is secured to Item 8 (Ref. A) by: Roll Pin, 1/8" ø X 1/2" Long, Washer (White Teflon), .137" ID X .25" OD X .01" Thick (Qty. 2) (242-5080-00) and is secured to Item 3 (Ref. B) by: #6-32 X 1/4" PPH MS (Sems) Zinc (Qty. 2) (232-5200-00)				Item 4 is secured above the P/F by: #6-32 X 5/8" HWH Swage (Serr.) Zinc (Qty. 2) (237-5976-04)			
				5	Coil Retaining Bracket	1	535-5203-03
				Item 5 is secured to Item 4 by: #8-32 X 1/4" PPH MS (Sms.) Zc. (Qty. 2/per) (232-5300-00)			
				6	Coil, 23-800 (Lugless)	1	090-5001-NL
				Coil has a Diode (1N4004) (112-5003-00) located on a Terminal Strip (see Take Note below).			
				7	Coil Sleeve (Modified)	1	545-5847-01
				8	Pivot Plunger Assembly	1	515-7349-00
				For Individual Items use : Shaft Pivot Plunger (530-5647-00) & Extension (530-5510-00)			
				9	Shaft Head	1	530-5511-00
				Item 9 is secured to Item 8 (@ bot) by: #10-32 X 3/8" PH Truss (Qty. 1) (237-5988-00)			
				10	Compression Spring	1	266-5009-00

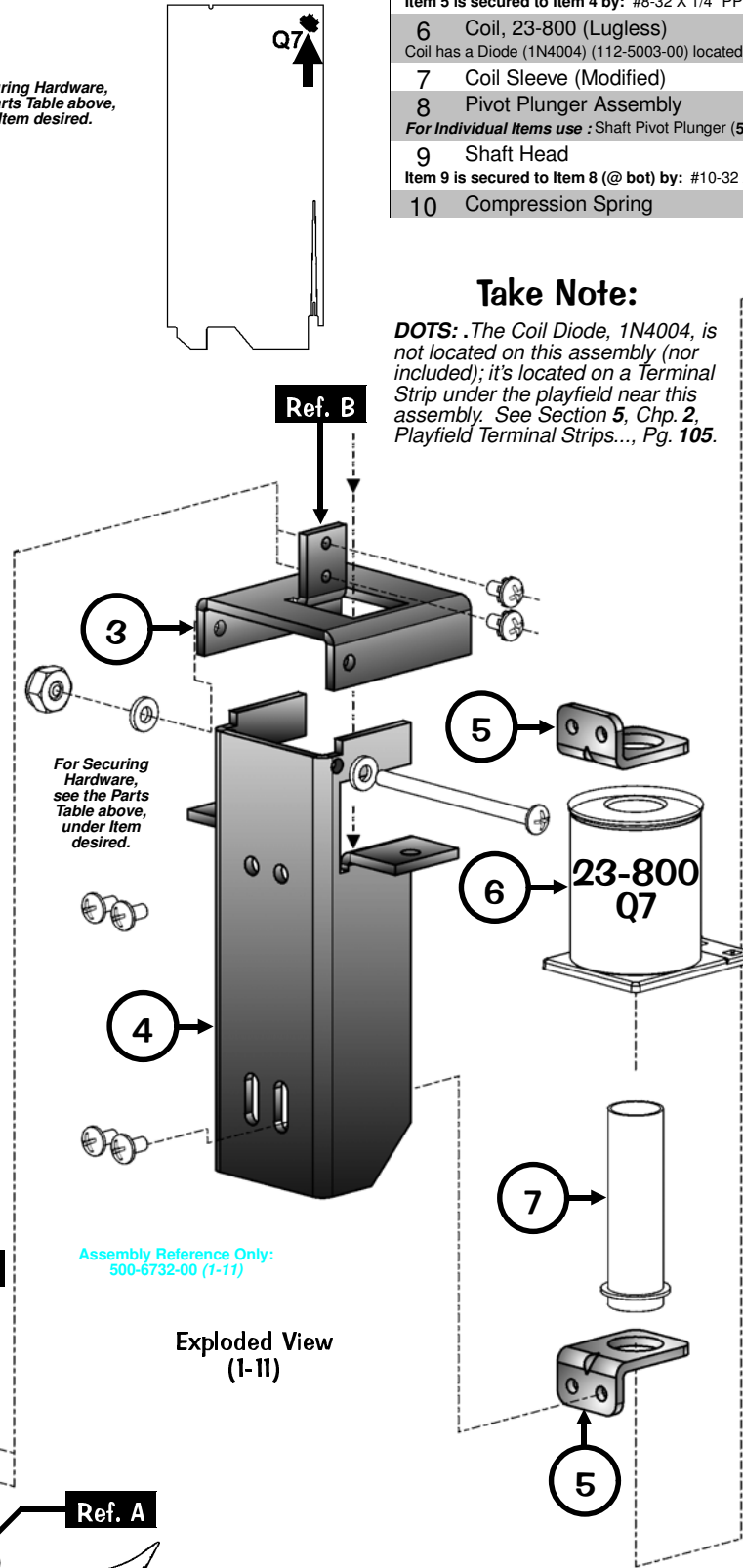
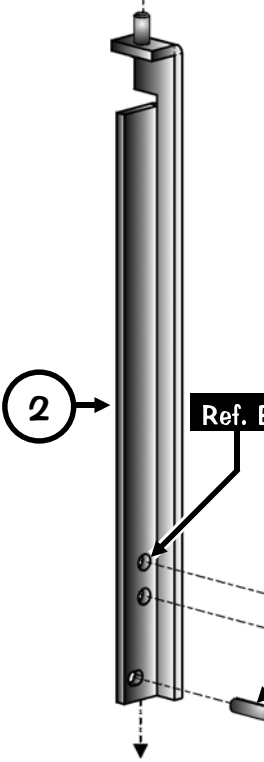
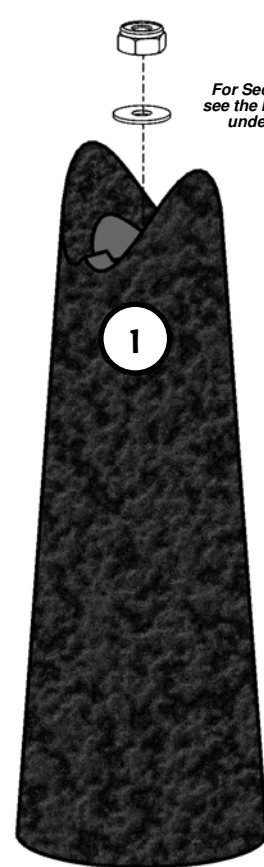

Take Note:
 DOTS: .The Coil Diode, 1N4004, is not located on this assembly (nor included); it's located on a Terminal Strip under the playfield near this assembly. See Section 5, Chp. 2, Playfield Terminal Strips..., Pg. 105.

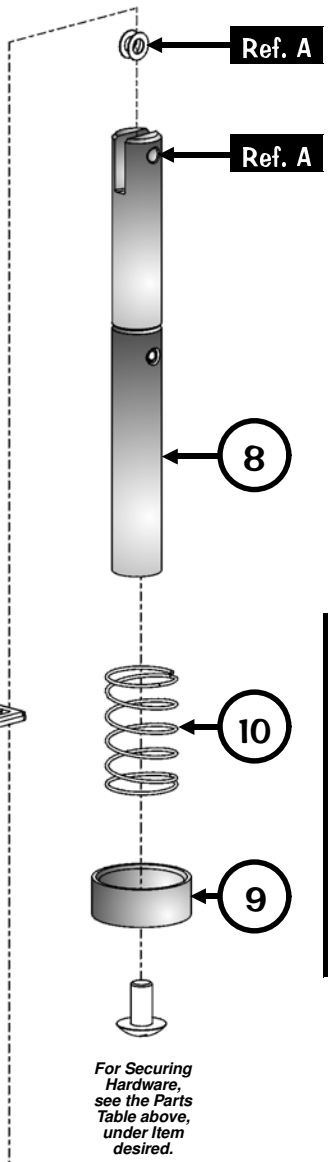

Drawings for Major Assemblies & Ramps



Sec. 4: Drawings ...

The Lord of the Rings Playfield Figurines (Characters) Overview



Balrog
545-5083-00
See Page 87.

Saruman
880-5080-00

Gandalf the Gray*
(Alternate, Not Shown)
880-5082-00

Gandalf the White
(riding Shadowfax)
880-5076-00

* This game used either Gandalf the Gray or the White and neither can be easily interchanged due to plastics, mounting and hardware. Character depictions in photos may not represent your games. Parts may change without notice due to ball-traps.

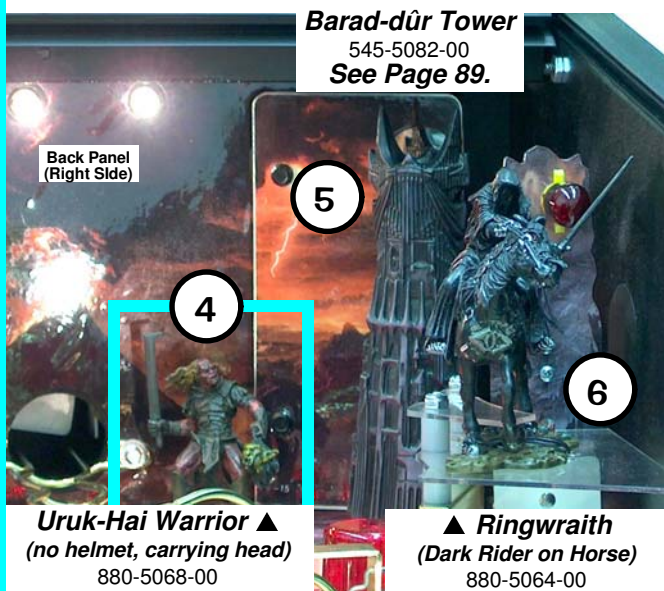

Barad-dûr Tower
545-5082-00
See Page 89.

Uruk-Hai Warrior ▲
(no helmet, carrying head)
880-5068-00

▲ Ringwraith
(Dark Rider on Horse)
880-5064-00

Uruk-Hai Warrior
(with helmet on) ▼
880-5070-00

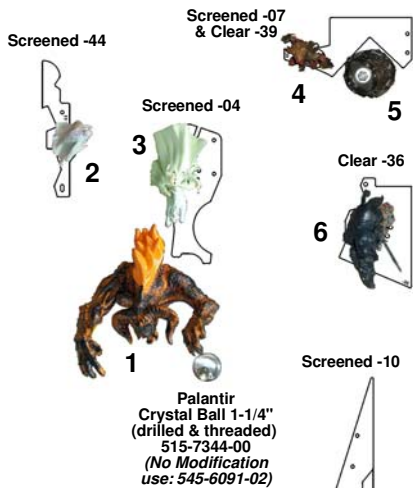

▲ Uruk Hai Mauhur
(no helmet)
880-5069-00



▲ Aragorn
(riding Horse)
880-5075-00

Sec. 4: Drawings ...

5-1/2" Cable Tie, use: 040-5001-02

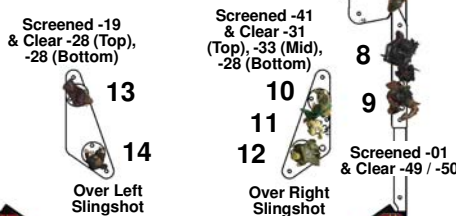

Pippin ▼
880-5071-00

▼ Merry
880-5078-00

Frodo ▼
880-5072-00

Note: Individual Plastics (Screened & Clear) are not available individually, ordering of kit is required. For all pieces, see Playfield - Plastics (Screened & Clear) & Decals, Page 67.

◀ Gollum
880-5063-00

Over Right Slingshot

Over Left Slingshot

▲ Samwise
880-5073-00

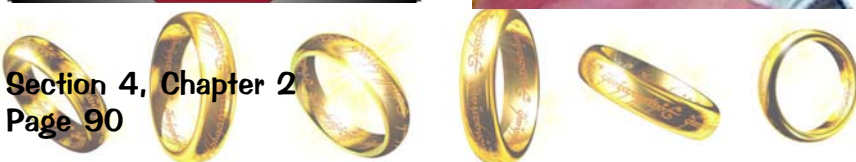

Down Post (Sword Ball Lock) Assembly, 500-6752-00 (Items 1-9)

When energized, the pinball is released to exit the Sword Ramp (Pg. 93).

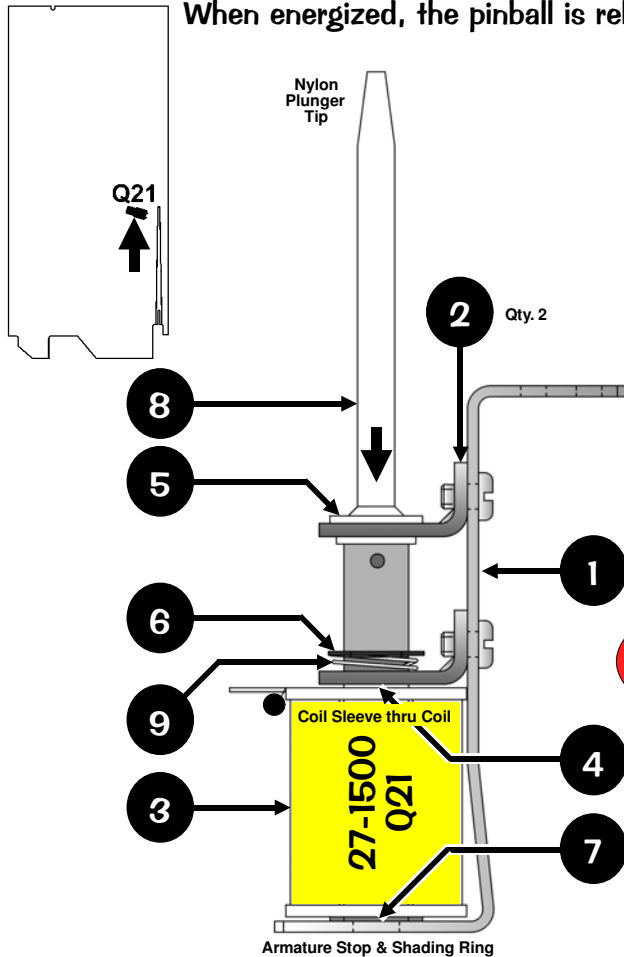

Nº	INDIVIDUAL PART NAME	QTY.	SPI PART Nº
1	Coil Mounting Bracket	1	515-7132-00
Item 1 is secured below the playfield by: #8 X 1/2" HWH AB (Zinc) (Qty. 3) (234-5101-00)			
2	Coil Retaining Bracket	2	535-5203-03
Item 2 is secured by: #8-32 X 1/4" PPH MS (Sems) Zinc (Qty. 2/per) (232-5300-00)			
3	Coil, 27-1500	1	090-5004-00T
Coil has a Diode (1N4004) (112-5003-00) positioned @ top (above lugs next to windings).			
4	Coil Sleeve	1	545-5411-00
5	Nyliner, 7/16" ø Shaft	1	545-5418-01
6	Retaining Ring, 7/16" ø Shaft	1	270-5005-00
7	Spring Washer, 17/32" ID X 3/4" X 1"	1	269-5002-00
8	Plunger (with Nylon Tip) Assembly	1	515-7350-00
For Individual Items use : Plunger (530-5315-00) & Nylon Tip (530-5656-00)			
9	Compression (Relay) Spring	1	266-5022-01

Ordering Note: If 500-6752-00 is unavailable, order the individual part(s) actually required.

For Securing Hardware, see the Parts Table above, under the item desired.

Plunger shown in its energized state (plunger down)

Take Note:

⊖ **Coil Note:** P Either -00B or -00T can be used for coil replacements. B/T listed is preferable for easier diode access & may differ on game.

Item 8 Note: Early Production games had a different Plunger Assembly and required a "flipper bushing" for a spacer. Some plunger tips may differ slightly but they all work the same. If replacing with above part, remove flipper bushing, if applicable.

30° Eject (Saucer) Assembly, 500-6511-11 (Items 1-8)

and Associated Part: See Parts Table below.

When energized, the pinball is kicked out of the Upper Right Orbit Saucer.

Nº	INDIVIDUAL PART NAME	QTY.	SPI PART Nº	Nº	INDIVIDUAL PART NAME	QTY.	SPI PART Nº
1	Mounting Bracket 30° Bend (Frame)	1	535-8932-02	7	Compression (Return) Spring	1	266-5022-01
Item 1 is secured below the playfield by: #8 X 1/2" HWH AB (Zinc) (Qty. 2) (234-5101-00)				8	Rubber Bumper (Grommet)	1	545-5105-00
2	Coil Retaining Bracket	1	535-5203-03	Ordering Note: If 500-6511-11 is unavailable, order the individual part(s) actually required.			
Item 2 is secured to Item 1 by: #8-32 X 1/4" PPH MS (Sems) (Qty. 2) (232-5300-00)				ASSOCIATED PART IS NOT INCLUDED WITH THE ABOVE ASSEMBLY.			
3	Coil, 26-1200	1	090-5044-00B	Nº ASSOCIATED PART NAME QTY. SPI PART Nº			
Coil has a Diode (1N4004) (112-5003-00) positioned @ bot (below lugs opposite windings).				AP-A	Switch Assembly	1	500-6520-00
4	Coil Sleeve (Short) (Formost #10-7077)	1	545-5076-01	For Individual Items use : Switch Bracket (535-6173-00), Micro Switch (180-5186-00), Switch Body Protect Plate (535-6539-00) and Diode 1N4004 (112-5003-00).			
5	Spring Washer (17/32" ID X 3/4" X 1")	1	269-5002-00				
6	Plunger (with Nylon Tip) Assembly	1	515-7197-00				

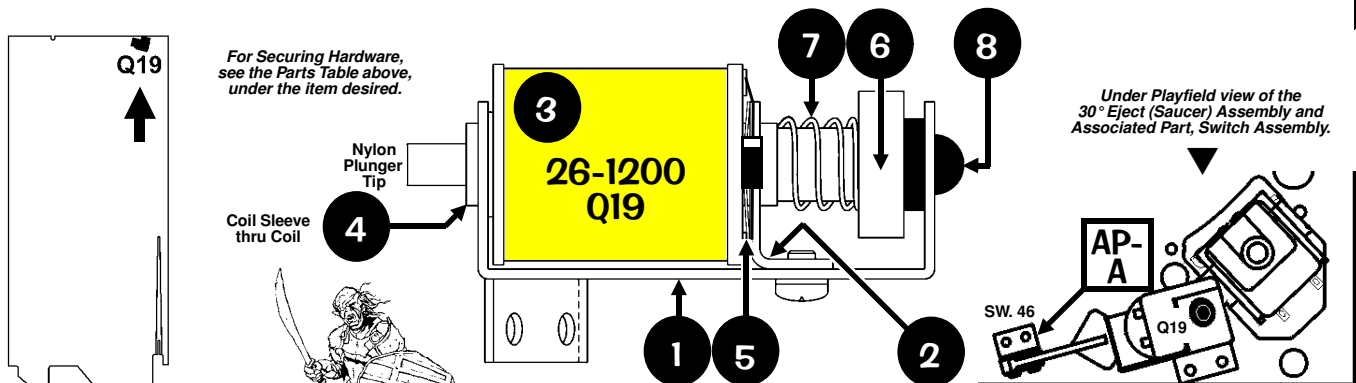

Drawings for Major Assemblies & Ramps



Upper Mini-Playfield, Left & Center Wire Ramps, Individual Parts Only (Items 1-14)

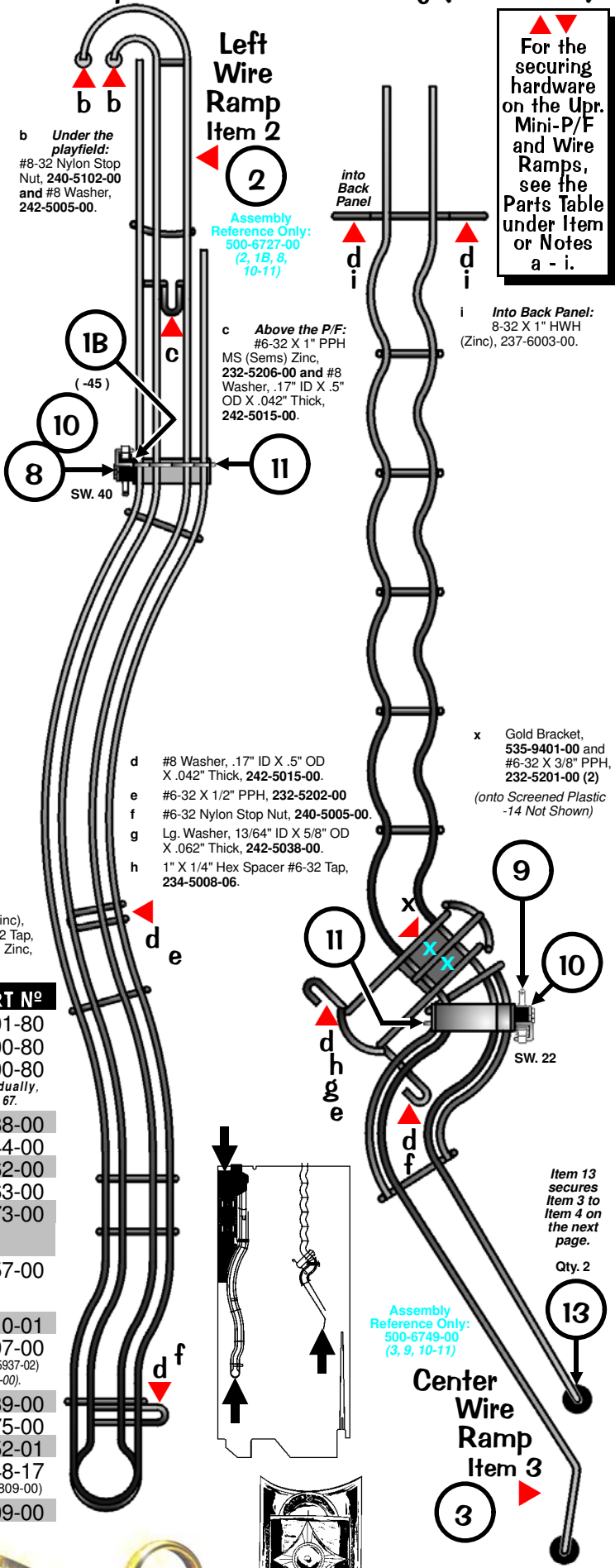
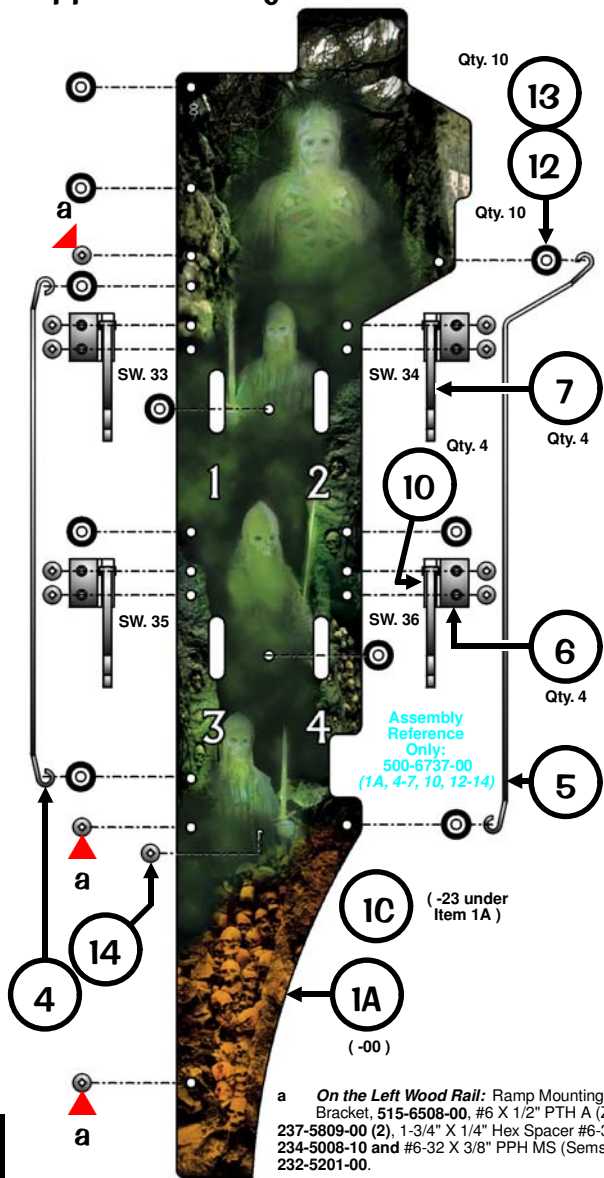

▲▲
For the securing hardware on the Upr. Mini-P/F and Wire Ramps, see the Parts Table under Item or Notes a - i.

a On the Left Wood Rail: Ramp Mounting Bracket, 515-6508-00, #6 X 1/2" PTH A (Zinc), 237-5809-00 (2), 1-3/4" X 1/4" Hex Spacer #6-32 Tap, 234-5008-10 and #6-32 X 3/8" PPH MS (Sems) Zinc, 232-5201-00.

b Under the playfield: #8-32 Nylon Stop Nut, 240-5102-00 and #8 Washer, 242-5005-00.

c Above the P/F: #6-32 X 1" PPH MS (Sems) Zinc, 232-5206-00 and #8 Washer, .17" ID X .5" OD X .042" Thick, 242-5015-00.

d #8 Washer, .17" ID X .5" OD X .042" Thick, 242-5015-00.
e #6-32 X 1/2" PPH, 232-5202-00
f #6-32 Nylon Stop Nut, 240-5005-00.
g Lg. Washer, 13/64" ID X 5/8" OD X .062" Thick, 242-5038-00.
h 1" X 1/4" Hex Spacer #6-32 Tap, 234-5008-06.

x Gold Bracket, 535-9401-00 and #6-32 X 3/8" PPH, 232-5201-00 (2) (onto Screened Plastic -14 Not Shown)

Sec. 4: Drawings ...

Nº	INDIVIDUAL PART NAME	QTY.	SPI PART Nº
1A	Kit: Thick Plastics (Screened) -00	1	803-5001-80
1B	Kit: Plastics (Screened) -45	1	803-5000-80
1C	Kit: Decals (Screened) -23	1	802-5000-80
<i>Note: Individual Thick Plastic (-00), Plastic (Clear -45) and Decal (-23) are not available individually, ordering of kit is required. For all pieces, see Playfield - Plastics (Screened & Clear) & Decals, Page 67.</i>			
2	Left Wire Ramp (No Parts)	1	535-9288-00
3	Center Wire Ramp (No Parts)	1	535-9344-00
4	Wire Form (Left Side)	1	535-9362-00
5	Wire Form (Right Side)	1	535-9363-00
6	Bracket, Switch Mounting	4	535-6173-00
<i>Item 6 is secured to Item 1A by: #6-32 X 1/2" PPH MS (Sems) Zinc (Qty. 2/per) (232-5202-00) and #6-32 Nylon Stop Nut (Qty. 2/per) (240-5005-00)</i>			
7	Micro Switch (High Form Flat Blade)	4	180-5057-00
<i>Item 7 is secured to Item 6 by: #2-56 X 1/2" HWH Ser Black (Qty. 2/per) (237-5937-02) and #2-56 Nylon Stop Nut (Qty. 2/per) (240-5321-00)</i>			
8	Micro Switch (1/8" Flat Blade)	1	180-5010-01
9	Micro Switch (1/8", 2x bend Flat Blade)	1	180-5197-00
<i>Items 8 & 9 are secured to Items 2 & 3 by: #2-56 X 1/2" HWH Ser Black (Qty. 2/per) (237-5937-02) Items 7 - 9: Switches have Diode (1N4004) (112-5003-00). Can be replaced with (1N4001) (112-5001-00).</i>			
10	Switch Body Protect Plate	6	535-6539-00
11	Wire Form (Ramp Roll-Under Gate)	2	535-9375-00
12	Mini-Jewel Plastic Post (Clear)	10	550-5052-01
13	Rubber Ring (Black), 7/16" O.D.	12	545-5348-17
<i>Items 12-13 are secured to Item 1A by: #6 X 1/2" PTH A (Zinc) (Qty. 1/per) (237-5809-00)</i>			
14	#6 X 1/2" PTH A (Zinc)	1	237-5809-00

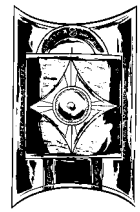

Center, Right, Sword and Shooter Lane Ramps Individual Parts Only (Items 1-17)

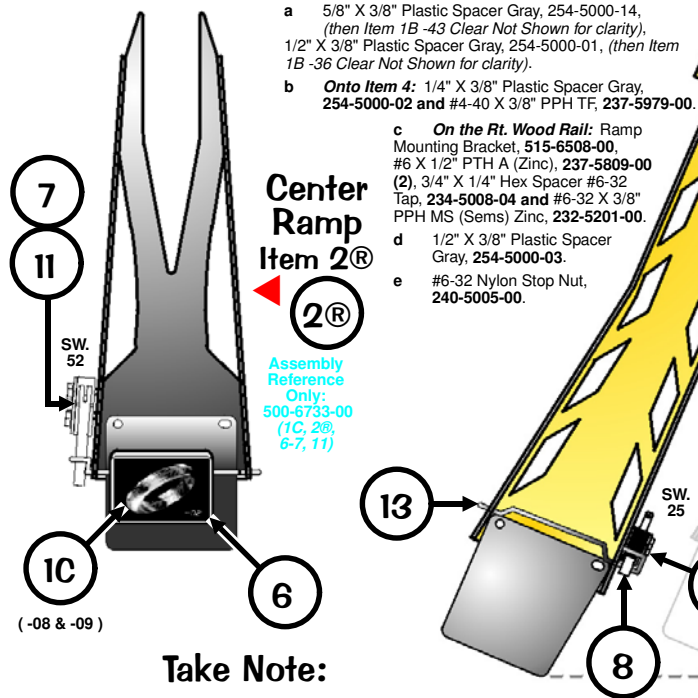

- a 5/8" X 3/8" Plastic Spacer Gray, 254-5000-14, (then Item 1B -43 Clear Not Shown for clarity), 1/2" X 3/8" Plastic Spacer Gray, 254-5000-01, (then Item 1B -36 Clear Not Shown for clarity).
- b **Onto Item 4:** 1/4" X 3/8" Plastic Spacer Gray, 254-5000-02 and #4-40 X 3/8" PPH TF, 237-5979-00.
- c **On the Rt. Wood Rail:** Ramp Mounting Bracket, 515-6508-00, #6 X 1/2" PTH A (Zinc), 237-5809-00 (2), 3/4" X 1/4" Hex Spacer #6-32 Tap, 234-5008-04 and #6-32 X 3/8" PPH MS (Sems) Zinc, 232-5201-00.
- d 1/2" X 3/8" Plastic Spacer Gray, 254-5000-03.
- e #6-32 Nylon Stop Nut, 240-5005-00.

Center Ramp Item 2®
 2®
 Assembly Reference Only:
 500-6733-00 (1C, 2®, 6-7, 11)

Take Note:

®"R" indicates Item noted is secured with rivet(s) as listed.

Nº	INDIVIDUAL PART NAME	QTY.	SPI PART Nº
1A	Kit: Thick Plastics (Screened) -03, -04	1	803-5001-80
1B	Kit: Plastics (Scr. & Clr.) -13, -24, 36, -43, -45 x2	1	803-5000-80
1C	Kit: Decals (Screened) -08, -09	1	802-5000-80

Note: Individual Thick Plastics (-03 & -04), Plastic (Clear -13) and Decals (-08 & -09) are not available individually, ordering of kit is required. For all pieces, see Playfield - Plastics (Screened & Clear) & Decals, Page 67.

2® Riveted Center Steel Ramp & Flap Assembly 1 515-7354-00
 Item 2 is secured through the playfield by: #8 Washer (Qty. 2) (242-5005-00) and #8-32 Nylon Stop Nut (Qty. 2) (240-5102-00)
For Individual Items use : Center Steel Ramp (No Parts) (515-7315-00) and Ramp Flap Left (535-9389-00) and is secured by: #6 Riveting Lock Washer (246-5000-00, Qty. 2) and Rivet, 1/8" ø X 3/16" Lg. (249-5001-00, Qty. 2)

3® Riveted Right Steel Ramp & Flap Assembly 1 515-7319-00-80
 Item 3 is secured through the playfield by: #8 Washer (Qty. 2) (242-5005-00) and #6-32 Nylon Stop Nut (Qty. 2) (240-5005-00)
For Individual Items use : Right Steel Ramp (No Parts) (515-7319-00) & Ramp Flap Right (535-9389-01) and is secured by: #6 Riveting Lock Washer (246-5000-00, Qty. 2) and Rivet, 1/8" ø X 3/16" Lg. (249-5001-00, Qty. 2)

4 Sword Steel Ramp (No Parts) 1 535-9289-00
5 Shooter Lane (Flat) Ramp 1 535-9051-00
 Item 5 is secured through the playfield by: #4-40 X 1/2" PFH (Zinc) (Qty. 2) (237-5840-00)

6 Spinner Target (Large) 1 515-7088-01
7 Micro Switch (Flat Blade) 1 180-5190-28
8 Micro Switch (1 1/8" Flat Blade) 1 180-5010-01
 Items 7 & 8 are secured by: #2-56 Nylon Stop Nut (Qty. 2/per) (240-5321-00)

9 Micro Switch (2-3/16", Flat Blade, 1 bend) 1 180-5198-00
 Item 9 is secured to Item 4 by: #2-56 X 3/8" HWH MS (Serr) Zinc TF 3/16" (Qty. 2/per) (237-5938-01)

10 Micro Switch (Roller Actuator, Lite Force) 3 180-5119-02
 Item 11 is secured to Item 10 by: #2-56 X 1/2" HWH Ser Blk. (Qty. 2/per) (237-5937-02)

11 Switch Body Protect Plate 5 535-6539-00
12® Sw. & Target Assy. 1" X 1 1/2" Rect. WHT 1 515-6027-08
 Item 12 is secured to Item 4 thru Item 1B (-13) by: #6-32 N. S. Nut (Qty. 2) (240-5005-00)

For Individual Items use : Stack Switch Radius End (180-5133-00), Washer 5/16" (242-5017-00), Rivet 1/8" ø X 3/16" (249-5001-00) and 1" Round Target (545-5456-08).
 Items 7-10 & 12: Switches have Diode (1N4004) (112-5003-00). Can be replaced with (1N4001) (112-5001-00).

13 Wire Form (Ramp Roll-Under Gate) 1 535-9393-01
14 Bracket, X3 Switch Mounting (under) 1 515-7341-00

15 Bracket, Hooded Ball Guide (over) 1 535-9406-00
 Items 14 & 15 are secured to Item 4 by: #6-32 X 3/8" HWH Swage (Serr) Zinc (Qty. 2) (237-5976-02) and #6-32 Nylon Stop Nut (Qty. 2) (240-5005-00)

16 #906 Wedge Base Bulb (Red) 1 165-5004-02
17 IDC Snap-On Socket No Diode 1 077-5216-01

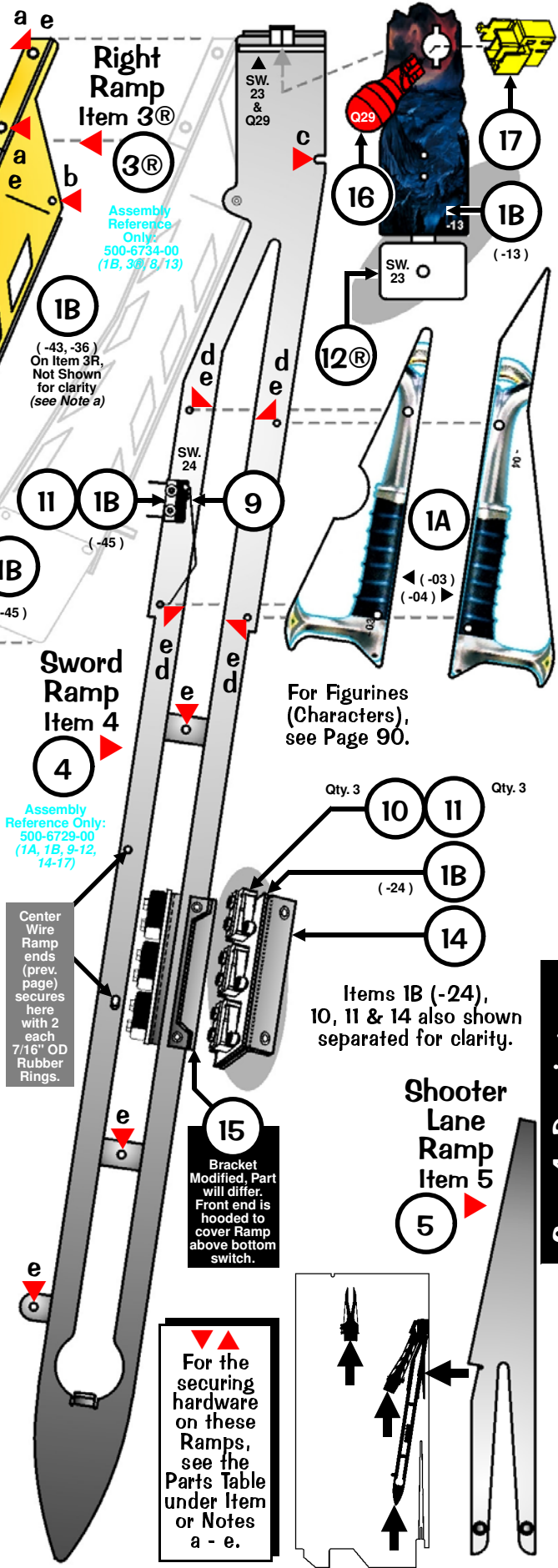

Sword Ramp Item 4
 4
 Assembly Reference Only:
 500-6729-00 (1A, 1B, 9-12, 14-17)

Center Wire Ramp ends (prev. page) secures here with 2 each 7/16" OD Rubber Rings.

15
 Bracket Modified Part will differ. Front end is hooded to cover Ramp above bottom switch.

For the securing hardware on these Ramps, see the Parts Table under Item a - e.

For Figurines (Characters), see Page 90.

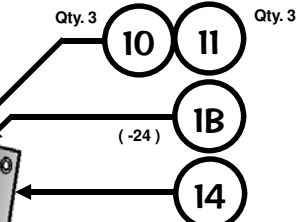

Items 1B (-24), 10, 11 & 14 also shown separated for clarity.

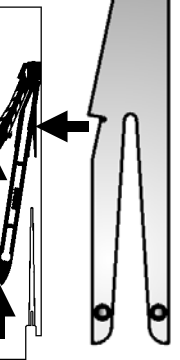
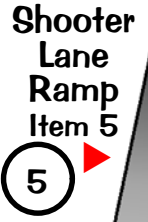

For Securing Hardware, see the Parts Table below, under Item desired.

Back Panel (Front View) Individual Parts Only, (Items 1-14)

Parts Table & Back View on continues on the next page.

Assembly Reference Only:
500-6723-00
(1A-15)

Exploded View & details of this Back Panel Trough Assembly on Page 97.

Exploded View (1-14)

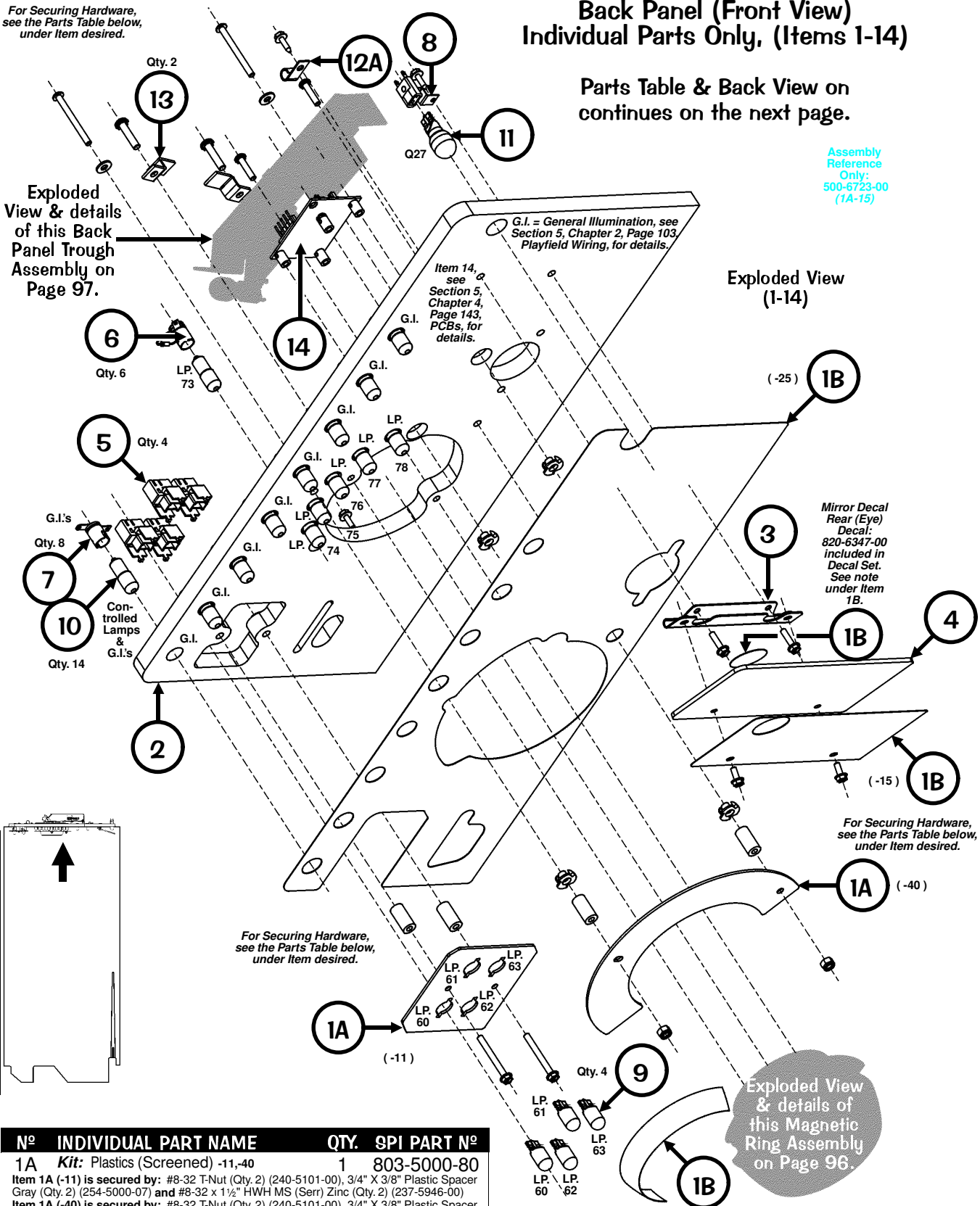

Sec. 4: Drawings ...

Nº	INDIVIDUAL PART NAME	QTY.	SPI PART Nº
1A	Kit: Plastics (Screened) -11,-40	1	803-5000-80
Item 1A (-11) is secured by: #8-32 T-Nut (Qty. 2) (240-5101-00), 3/4" X 3/8" Plastic Spacer Gray (Qty. 2) (254-5000-07) and #8-32 x 1 1/2" HWH MS (Serr) Zinc (Qty. 2) (237-5946-00)			
Item 1A (-40) is secured by: #8-32 T-Nut (Qty. 2) (240-5101-00), 3/4" X 3/8" Plastic Spacer Gray (Qty. 2) (254-5000-07), #8 Washer (Qty. 2) (242-5005-00), #8-32 X 1 1/4" PPH MS (Zinc) (Qty. 2) (237-5611-00) and #8-32 Nylon Stop Nut (Qty. 2) (240-5102-00)			
1B	Kit: Decals (Screened) noted & -15, -25	1	802-5000-80
Note: Individual Plastics (-11 & -40) and Decals (820-6347-00, -6348-00, -15 & -25) are not available individually, ordering of kit is required. For all pieces, see <i>Playfield - Plastics (Screened & Clear) & Decals</i> , Page 67.			
2	Back Panel (Black Wood, Plain No Parts)	1	525-5636-00
Item 2 is secured under the Playfield by: Bracket, Back Panel Mounting (Not Shown) (Qty. 2) (535-8964-00) and #8 X 1/2" HWH AB (Zinc) (Qty. 4/per) (234-5101-00)			

Nº	INDIVIDUAL PART NAME	QTY.	SPI PART Nº
3	Mirror Mounting Bracket	1	535-9397-00
Item 3 is secured to Item 2 by: #8-32 T-Nut (Qty. 2) (240-5101-00) and #8-32 X 5/8" HWH MS (Serr) Zinc TF (Qty. 2) (237-5951-00)			

Continued next Page 95 (Top) ▶



Section 4, Chapter 2
Page 94



Drawings for Major
Assemblies & Ramps

Back Panel (Back View) Continued Individual Parts Only, (Items 1-14)

Parts Table and Front View on previous page.

Nº	INDIVIDUAL PART NAME	QTY.	SPI PART Nº
◀ Continued from Page 94 (Bottom)			
4	Mirror Panel	1	820-6297-01
Item 4 is secured to Item 3 by: #8-32 X 3/8" HWH MS Type C (Qty. 2) (237-5903-00)			
5	IDC Snap-On Socket No Diode	4	077-5216-01
6	3-Lug Staple-Dn. Bayonet Socket	6	077-5001-00
Items 5 - 6: Lamps have Diode (1N4004) (112-5003-00). Can be replaced with (1N4001) (112-5001-00). Item 7: G.I. Sockets do not require a diode.			
7	2-Lug Staple-Dn. Bayonet Socket	8	077-5000-00
8	Wedge Base Socket (Offset)	1	077-5029-00
9	#555 Wedge Base Bulb (Green)	4	165-5054-04
Items 9: Can replace with #555 Wedge Base Bulb (Clear) (165-5002-00) with the use of a Green Lite Cover (545-5014-04). Green is preferred.			
10	#44 Bulb Bayonet Socket	14	165-5000-44
11	#906 Wedge Base Bulb (Clear)	1	165-5004-00
12A	1/4" Cable (Single) Clamp	1	040-5000-03
12B	1/2" Cable (Single) Clamp	1	040-5000-06
Items 12A & 12B are secured to Item 2 by: #8 X 1/2" HWH AB (Zinc) (Qty. 1/per) (234-5101-00)			
13	Magnet Bracket	2	535-9396-00
Item 13 is secured to Item 2 by: #10-32 X 7/8" PPH MS (Sems) Zinc (Qty. 1/per) (232-5405-00)			
14	OPTO Trans./Rec. Amplifier PCB	1	520-5239-00
Item 14 is secured to Item 2 by: 3/8" Sif. Rtn. Plastic Spacer White (Qty. 4) (254-5007-01) & #6 X 7/8" PPH AB (Zinc) (Qty. 4) (237-5003-00)			

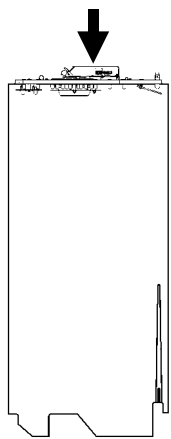
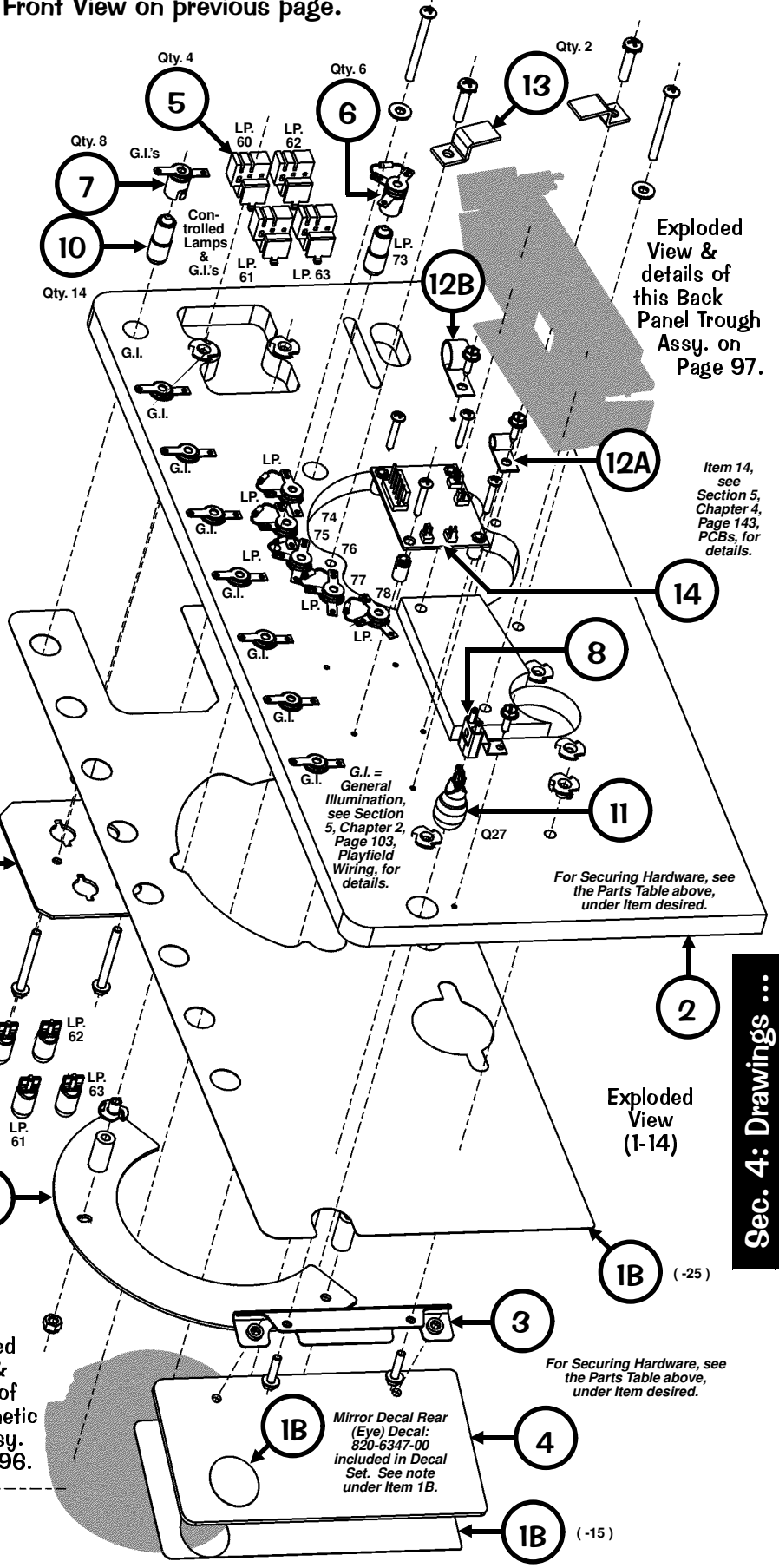

Transparent Ring Cover Decal: 820-6348-00 included in Decal Set. See note under Item 1B.

Assembly Reference Only: 500-6723-00 (1A-15)

Drawings for Major Assemblies & Ramps



Sec. 4: Drawings ...

Magnetic Ring Assembly Individual Parts Only (Items 1-7)
 Located on the front of the Back Panel
 (see Pages 94-95 for complete Back Panel Exploded Front & Back Views).

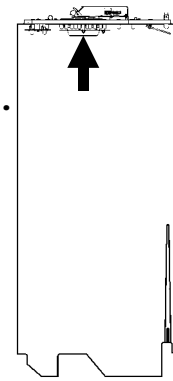

Assembly Reference Only:
 500-6718-00
 (1@-7)

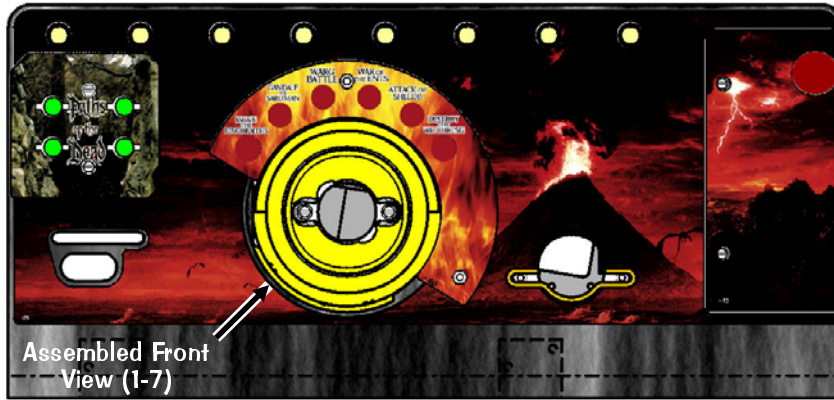

Nº	INDIVIDUAL PART NAME	QTY.	SPI PART Nº
1®	Riveted Magnetic Ring (Vacuum Form) Asm.	1	515-7345-00
Item 1 is secured to Item 4 by: #4-40 X 3/8" HWH MS (Zinc) TF (Qty. 4) (237-5933-00) For Individual Items use (requires drilling out rivets & re-venting) : Gold Plastic Ring (545-6095-00), Bracket, Mounting (535-9362-00, Qty. 4) and Pop Rivet, 1/8" ø X 3/16" (249-5025-00, Qty. 4)			
2	Ring Funnel (Plastic)	1	545-6096-00
Item 2 is secured to Items 3 & 4 by: #6-32 X 1/4" HWH Swage (Serr) Zinc (Qty. 2) (237-5976-00)			
3	Magnet Bushing	1	545-5966-01
4	Ring Mounting Plate	1	535-9379-00
5	Coil (Magnet), 20½-480	1	090-5064-02
6	OPTO Transmitter PCB Assembly	1	500-6746-00
7	OPTO Receiver PCB Assembly	1	500-6747-00
Items 6 & 7 are secured to Item 4 by: #4-40 x 1/2" PPH MS (Sems) Zinc (Qty. 2/per) (237-5813-00) For Individual Parts use : See Section 5, Chapter 4, Page 143, PCBs, for details.			

20½-480 Q6

Alternate Front View (7)

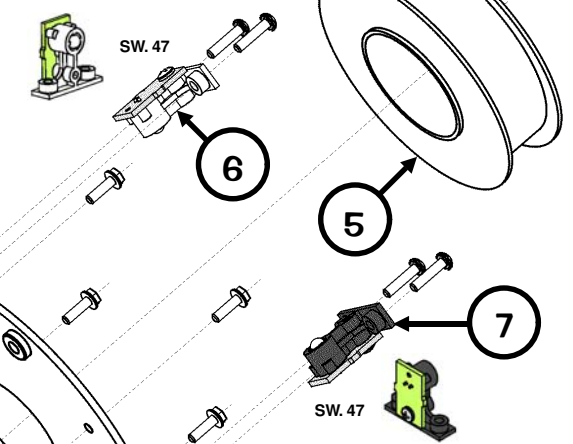

Alternate Rear View (7)

Items 6 & 7, see Section 5, Chapter 4, Page 143, PCBs, for details.

Take Note:

® "R" indicates Item noted is secured with rivet(s) as listed.

Exploded View (1-7)

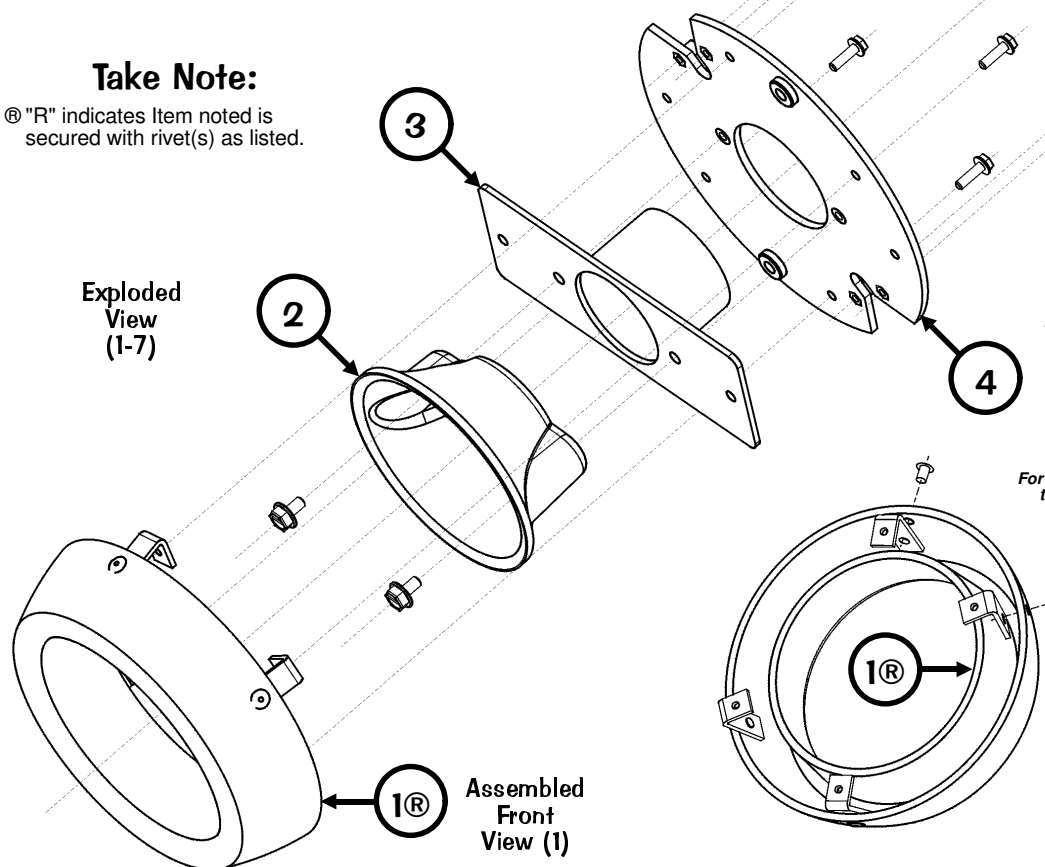

For Securing Hardware, see the Parts Table above, under Item desired.

Sec. 4: Drawings ...

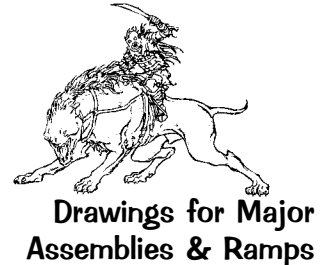

Back Panel Trough Assembly Individual Parts Only (Items 1-5)
 Located on the rear of the Back Panel
 (see Pages 94-95 for complete Back Panel Exploded Front & Back Views).

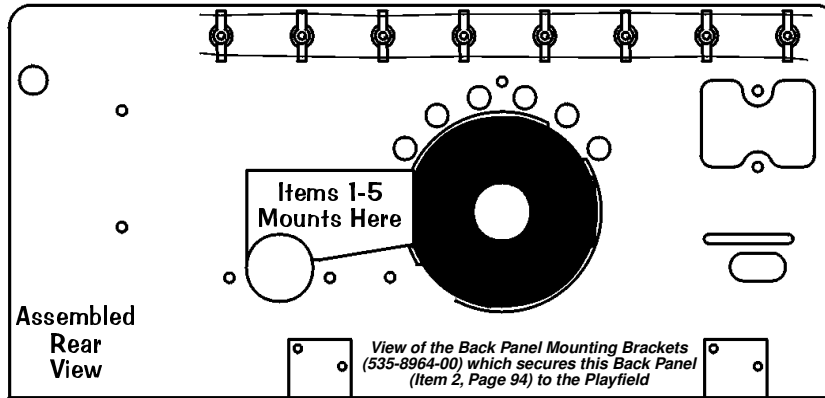
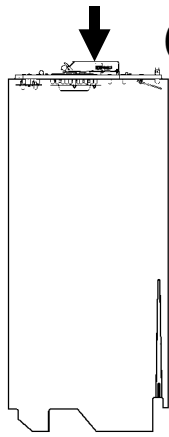

Assembly Reference Only:
 500-6748-00
 (1-4)

Nº	INDIVIDUAL PART NAME	QTY.	SPI PART Nº	Nº	INDIVIDUAL PART NAME	QTY.	SPI PART Nº
1	Ball Trough (Back Panel)	1	535-9345-00	3	#906 Wedge Base Bulb (Clear)	1	165-5004-00
Item 1 is secured to the Back Panel by: #8-32 X 3/4" PPH MS (Sems) Zinc (Qty. 2) (232-5304-00)				4	Micro Switch (High Form Flat Blade)	1	180-5057-00
2	Wedge Base Socket (Offset)	1	077-5029-00	5	Switch Body Protect Plate	1	535-6539-00
Item 2 is secured to Item 1 by: #4-40 X 5/8" PPH MS (Sems) Zinc (Qty. 1) (237-5832-00), Blk. Rbr. Ring, 3/8" O.D. (Qty. 1) (545-5348-19) and #4-40 N. Stop Nut (Qty. 1) (240-5303-00)				Items 4 & 5 are secured to Item 1 by: #2-56 X 1/2" HWH Ser Blk (Qty. 2/per) (237-5937-02) Switch has a Diode (1N4004) (112-5003-00). Can be replaced with (1N4001) (112-5001-00).			

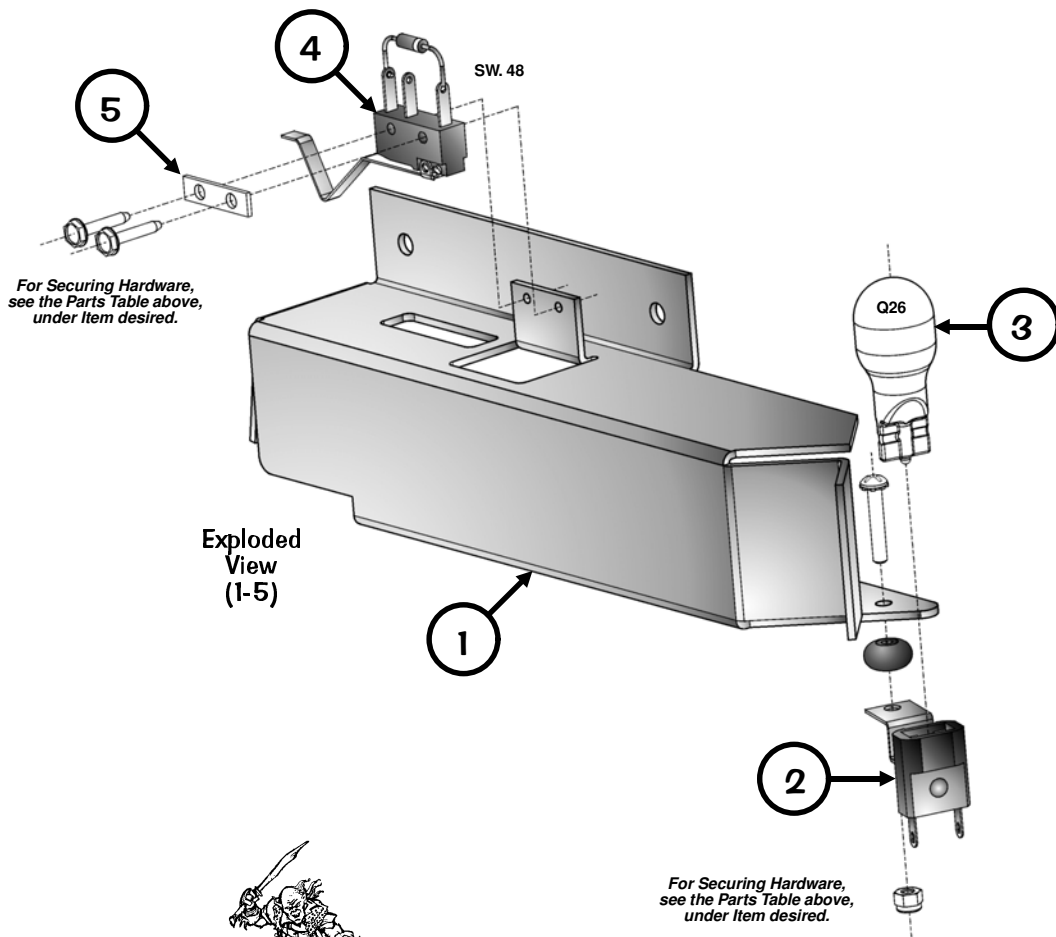

Sec. 4: Drawings ...



UK ONLY OPTIONAL
Ball Deflector Assemblies, 500-5788-02
(Qty. 2) (Items 1-8)

UK ONLY OPTIONAL
Up/Down Post Assy., 500-6293-00
(Items 1-9)

Nº	INDIVIDUAL PART NAME	QTY.	SPI PART Nº
1	Ball Deflector Coil Mounting Bracket	1	535-6857-02
Item 1 is secured below the playfield by: #8 X 1/2" HWH AB (Zinc) (Qty. 4) (234-5101-00)			
2	Coil Retaining Bracket	1	535-5203-03
Item 2 is secured by: #8-32 X 1/4" PPH MS (Sems) Zinc (Qty. 2) (232-5300-00)			
3	Coil, 26-1200	1	090-5044-00T
Coil has a Diode (1N4004) (112-5003-00) positioned @ top (above lugs next to windings).			
4	Coil Sleeve (Short) (Formost #10-7077)	1	545-5076-01
5	Spring Washer (17/32" ID X 3/4" X 1")	1	269-5002-00
6	Solid Plunger Assembly	1	515-6858-00
7	Compression (Relay) Spring	1	266-5022-01
8	#10-32 Adj. Spindle Stop w/Rubber Tip	1	280-5014-00
Item 8 is secured by: #10-32 Keps Nut (Qty. 1) (240-5208-00)			

Ordering Note: If 500-5788-02 is unavailable, order the individual part(s) actually required.

Nº	INDIVIDUAL PART NAME	QTY.	SPI PART Nº
1	Up/Down Post Coil Mounting Bracket	1	515-6840-00
Item 1 is secured below the playfield by: #8 X 1/2" HWH AB (Zinc) (Qty. 6) (234-5101-00)			
2	Adjustment Spindle Stop Bracket	1	535-8303-00
3	Coil Retaining Bracket	2	535-7356-00
Items 2 & 3 are secured by: #8-32 X 3/8" Swage (Serr) Zinc (Qty. 2/per) (237-5975-00)			
4	Coil, 23-1100 (ORG)	1	090-5030-00T
Coil has a Diode (1N4004) (112-5003-00) positioned @ top (above lugs next to windings).			
5	Coil Sleeve (with extension)	1	545-5847-00
6	Spring Washer, 17/32" ID X 3/4" X 1"	1	269-5002-00
7	Plunger & Shaft Assembly	1	515-6844-00

ORDERING ABOVE (ITEM 7) SUB-ASSY. PART Nº WILL INCLUDE:

7A	Ball Bumper Plastic (Top) Red	1	550-5029-02
7B*	Roll Pin, 3/32" ø X 1/2" Long	1	251-5002-00
7C*	Retaining Ring, 1/4" ø Shaft	1	270-5002-00
7D	Plunger & Shaft Sub-Assembly	1	515-6841-00
7E	Plunger Head	1	530-5511-00
7F	#10-32 X 3/8" PPH MS (Sems) Zinc	1	232-5401-00

Ordering Note: If 515-6844-00 is unavailable, order the individual part(s) actually required. Item 7D, part of Item 7, Plunger & Shaft Sub-Assembly, is 1 piece and cannot be ordered separated.

8	Compression (Relay) Spring	1	266-5022-01
9	#10-32 Adj. Spindle Stop w/Rubber Tip	1	280-5014-00

Item 9 is secured by: #10-32 Keps Nut (Qty. 1) (240-5208-00)

Ordering Note: If 500-6293-00 is unavailable, order the individual part(s) actually required.

Take Note:

⊖ **Coil Note:** ⊖ Either -00B or -00T can be used for coil replacements. B/T listed is preferable for easier diode access & may differ on game.

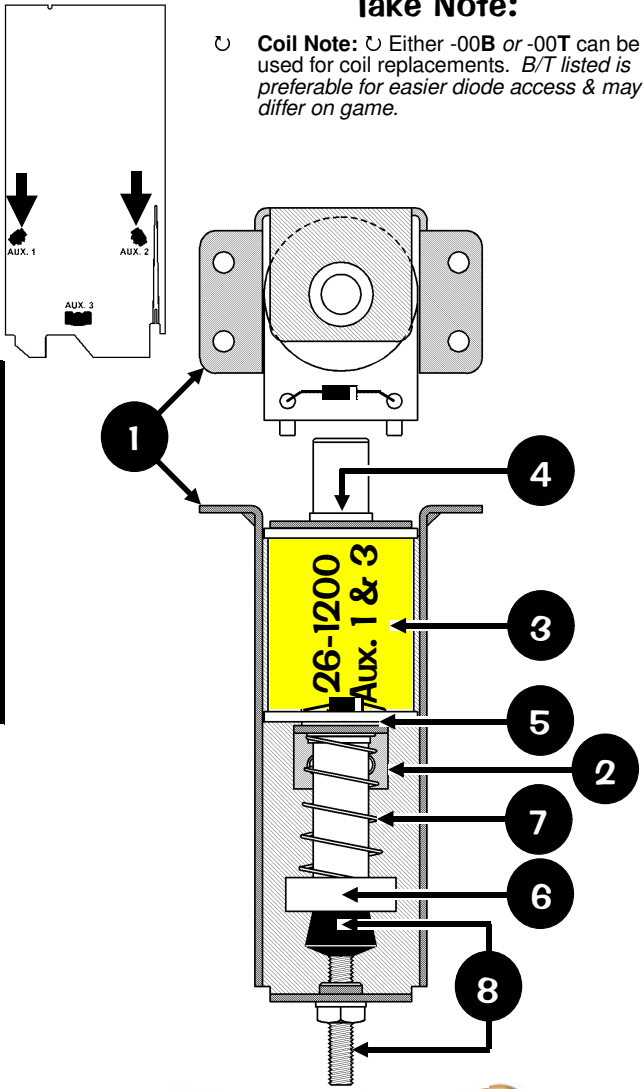

Sec. 4: Drawings ...



Take Note:

* An asterisk (*) indicates item(s) are not noted in the pictorials.
 ⊖ **Coil Note:** ⊖ Either -00B or -00T can be used for coil replacements. B/T listed is preferable for easier diode access & may differ on game.

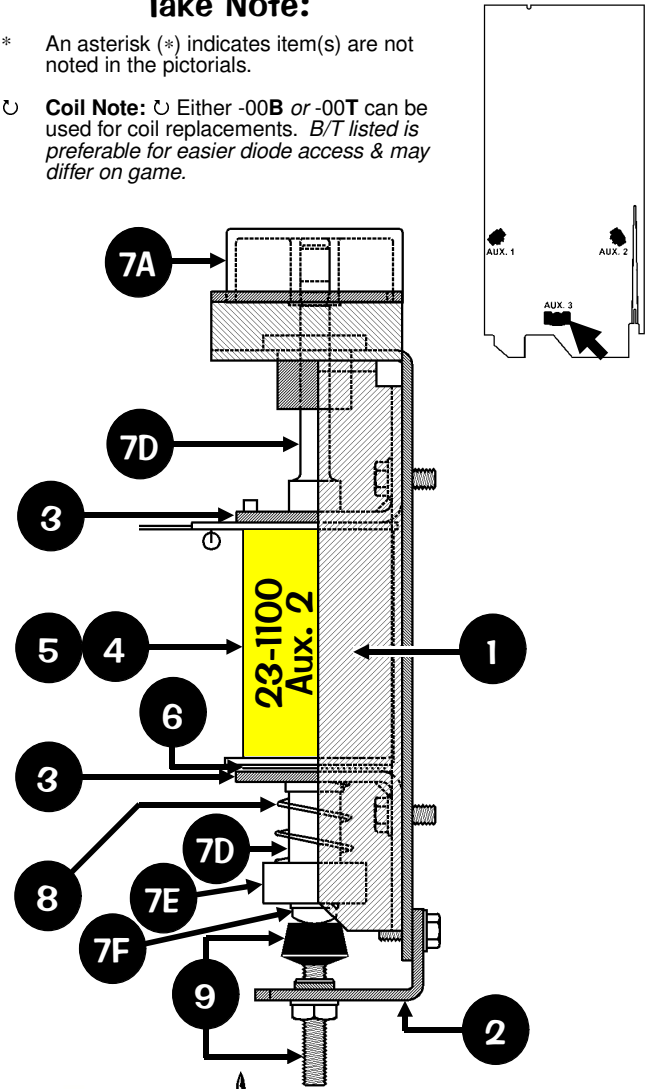

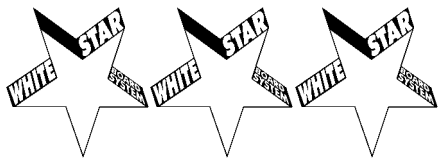

Section 5 Schematics & Troubleshooting Table of Contents

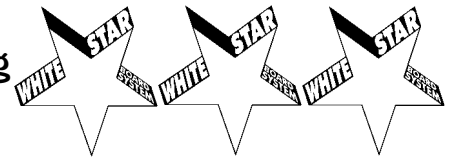

- COILS DETAILED CHART TABLE..... 100
- Chapter 1, Backbox Wiring101
 - Backbox I/O Power Driver Board Detailed Wiring Diagram..... 101
 - Backbox Board Layout Wiring Diagram 102
- Chapter 2, Playfield Wiring.....103
 - General Illumination Circuit Detailed Wiring Diagram 103
 - Playfield Switch Wiring Diagram & Playfield Lamp Wiring Diagram 104
 - Playfield Terminal Strips, Fuses & Misc. Wiring Descriptions & Locations 105
 - 2-Flipper Circuit Wiring Diagram 106
- Chapter 3, Cabinet Wiring..... 107
 - Transformer Power Wiring Diagram107
 - Cabinet / Coin Door Wiring Diagram 108
- Chapter 4, Printed Circuit Boards (PCBs)109
 - Trough Up-Kicker Dual OPTO Boards Theory of Operation & Schematic..... (Top) 109
 - Trough Up-Kicker Dual OPTO Boards Component Layout & Parts (Bot) 109
 - OPTO Troubleshooting (Top) 110
 - Trough Dual OPTO Boards Alignment / Tests for LED1 & LED2..... 110-111
 - Dot Matrix Display / Display Controller Bd. Combined Display Connections 112
 - Display Power Supply Board Schematic, Component Layout & Parts 113
 - Display Controller Board Schematic 114-115
 - Display Controller Board Component Layout & Parts 116
 - I/O Power Driver Board Theory of Operation 117
 - I/O Power Driver Board Schematic
(Sheet 1 of 5), (Sheet 2 of 5), (Sheet 3 of 5), (Sheet 4 of 5), (Sheet 5 of 5)..... 118-127
 - I/O Power Driver Board Component Layout 128
 - I/O Power Driver Board Parts 129
 - CPU/Sound Board II (with ATMEL Processor) Theory of Operation..... 131
 - CPU/Sound Board II (with ATMEL Processor) Schematic
(Sheet 1 of 4), (Sheet 2 of 4), (Sheet 3 of 4), (Sheet 4 of 4) 132-139
 - CPU/Sound Board II (with ATMEL Processor) Component Layout 140
 - CPU/Sound Board II (with ATMEL Processor) Parts..... 141
 - Playfield Switch Single OPTO Transmitter & Receiver Boards Schematic,
Component Layout & Parts..... 142
 - Back Panel Switch Mini OPTO Transmitter & Receiver Boards Schematic,
Component Layout & Parts..... (Top) 143
 - Back Panel OPTO Trans./Rec. Amplifier Bd. Component Layout & Parts (Bot) 143
 - Playfield 19-LED PC Board Component Layout..... 144
 - UK & Special App. 3X Transistor Driver Bd. Schematic & Component Layout 145
 - UK 3X Transistor Driver Bd. for Up-Posts & P/F 19-LED Overview & Wiring..... 146
 - UK 3X Trans. Driver Board ... with the Tournament Serial Interface (TSI) Board.....147
 - Tournament Serial Interface Board Schematic 148-149
 - Tournament Serial Interface Board Component Layout 150

Visit www.SternPinball.com/schematics.htm for the latest 11" X 17" Schematics (or "Split 8-1/2" X 11") for the Display Power Supply, Display Controller, I/O Power Driver & CPU/Sound Boards (White Star System Only). Along with the schematics you'll find the component layout and theory of operation. Keep visiting as these files are updated. If you have any comments or corrections, please email them to sternpinball@sternpinball.com. If you have any questions, please email them to sternpinball@sternpinball.com.
 To "download" once open, in your browser click "File" "Send" "Page by eMail". It will be sent to your eMail Address, where there you can save the file to your hardrive.

Sec. 5: Schematics ...

All 11 X 17 Schematics and other PDF files are also available on CD-ROM.

Schematics & Troubleshooting

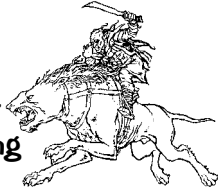

Use the below **Coils Detailed Chart Table** in conjunction with *Sec. 5, Chp. 1, Backbox I/O Power Driver Board Detailed Wiring Diagram (I/O Board Connectors J6, J7, J8 & J9) and Backbox Board Layout Wiring Diagram:*

COILS DETAILED CHART TABLE

High Current Coils Group 1		Drive Transistor	Driver Output Board	Power Line Color	Power Line Connection	Power Voltage	Drive Transistor Control Line Color	D.T. Control Line Connect	Coil GA-Turn or Bulb Type
#1	TROUGH UP-KICKER	Q1	▲ I/O Power Driver ▼	YEL-VIO	J10-P4/5	50v DC	BRN-BLK	J8-P1	26-1200 ♂ 090-5044-00T
#2	AUTO LAUNCH	Q2		YEL-VIO	J10-P4/5	50v DC	BRN-RED	J8-P3	24-940 ♂ 090-5036-00T
#3	LEFT VUK	Q3		YEL-VIO	J10-P4/5	50v DC	BRN-ORG	J8-P4	26-1200 ♂ 090-5044-00B
#4	TOP VUK	Q4		YEL-VIO	J10-P4/5	50v DC	BRN-YEL	J8-P5	26-1200 ♂ 090-5044-00B
#5	RIGHT VUK	Q5		YEL-VIO	J10-P4/5	50v DC	BRN-GRN	J8-P6	26-1200 ♂ 090-5044-00B
#6	RING MAGNET	Q6		VIO-YEL	J10-P3	50v DC	BRN-BLU	J8-P7	20 ¹ / ₂ -480 ♂ 090-5064-02
#7	RIGHT TOWER	Q7		YEL-VIO	J10-P4/5	50v DC	BRN-VIO	J8-P8	23-800 090-5001-NL
#8	LOOP DIVERTER	Q8		GRY-YEL-3A Fuse-YEL-VIO	J10-P1/2	50v DC	BRN-GRY	J8-P9	22-1080 ♂ 090-5032-00T
Diode On Terminal Strip (if noted)									
High Current Coils Group 2		Drive Transistor	Driver Output Board	Power Line Color	Power Line Connection	Power Voltage	Drive Transistor Control Line Color	D.T. Control Line Connect	Coil GA-Turn or Bulb Type
#9	LEFT BUMPER	Q9	▲ I/O Power Driver ▼	YEL-VIO	J10-P4/5	50v DC	BLU-BRN	J9-P1	26-1200 ♂ 090-5044-00T
#10	RIGHT BUMPER	Q10		YEL-VIO	J10-P4/5	50v DC	BLU-RED	J9-P2	26-1200 ♂ 090-5044-00T
#11	BOTTOM BUMPER	Q11		YEL-VIO	J10-P4/5	50v DC	BLU-ORG	J9-P4	26-1200 ♂ 090-5044-00T
#12	NOT USED	Q12					BLU-YEL	J9-P5	
#13	ORBIT PIN	Q13		BRN	J7-P1	20v DC	BLU-GRN	J9-P6	26-1200 ♂ 090-5044-00B
#14	FLASH: HELMS DEEP RT	Q14		ORG	J6-P10	50v DC	BLU-BLK	J9-P7	#906 Bulb 165-5004-00
#15	LEFT FLIPPER (50v RED/YEL)	Q15		GRY-YEL-3A Fuse-RED-YEL	J10-P1/2	50v DC	ORG-GRY	J9-P8	22-900 ♂ 090-5020-20T
#16	RIGHT FLIPPER (50v RED/YEL)	Q16		BLU-YEL-3A Fuse-RED-YEL	J10-P1/2	50v DC	ORG-VIO	J9-P9	22-900 ♂ 090-5020-20T
Low Current Coils Group 1		Drive Transistor	Driver Output Board	Power Line Color	Power Line Connection	Power Voltage	Drive Transistor Control Line Color	D.T. Control Line Connect	Coil GA-Turn or Bulb Type
#17	LEFT SLINGSHOT	Q17	▲ I/O Power Driver ▼	BRN	J7-P1	20v DC	VIO-BRN	J7-P2	23-800 ♂ 090-5001-00T
#18	RIGHT SLINGSHOT	Q18		BRN	J7-P1	20v DC	VIO-RED	J7-P3	23-800 ♂ 090-5001-00T
#19	TOP SAUCER	Q19		BRN	J7-P1	20v DC	VIO-ORG	J7-P4	26-1200 ♂ 090-5044-00B
#20	BALROG MOTOR RELAY	Q20		BRN	J7-P1	20v DC	VIO-YEL	J7-P6	DC Relay 520-5066-00
#21	SWORD LOCK RELEASE	Q21		BRN	J7-P1	20v DC	VIO-GRN	J7-P7	27-1500 ♂ 090-5004-00T
#22	BALROG MOTOR	Q22		BRN	J7-P1	20v DC	VIO-BLU	J7-P8	Motor 041-5088-01
#23	FLASH: HELMS DEEP LT	Q23		ORG	J6-P10	20v DC	VIO-BLK	J7-P9	#906 Bulb 165-5004-00
#24	OPTIONAL COIL	Q24		RED	J16-P7	5v DC	VIO-GRY	J7-P10	Opt. 5v
Low Current Coils Group 2		Drive Transistor	Driver Output Board	Power Line Color	Power Line Connection	Power Voltage	Drive Transistor Control Line Color	D.T. Control Line Connect	Coil GA-Turn or Bulb Type
#25	FLASH: POPS X3	Q25	▲ I/O Power Driver ▼	ORG	J6-P10	20v DC	BLK-BRN	J6-P1	#906 Bulb 165-5004-00
#26	FLASH: RING	Q26		ORG	J6-P10	20v DC	BLK-RED	J6-P2	#906 Bulb 165-5004-00
#27	FLASH: BACK PANEL	Q27		ORG	J6-P10	20v DC	BLK-ORG	J6-P3	#906 Bulb 165-5004-00
#28	NOT USED	Q28					BLK-YEL	J6-P4	
#29	FLASH: RINGWRAITH	Q29		ORG	J6-P10	20v DC	BLK-GRN	J6-P5	#906 Red 165-5004-02
#30	FLASH: SWORD	Q30		ORG	J6-P10	20v DC	BLK-BLU	J6-P6	#906 Bulb 165-5004-00
#31	FLASH: DESTROY THE RING	Q31		ORG	J6-P10	20v DC	BLK-VIO	J6-P7	#89 Bulb 165-5000-89
#32	FLASH: BALROG	Q32		ORG	J6-P10	20v DC	BLK-GRY	J6-P8	#89 Bulb 165-5000-89
Note: In Test Flash Lamps Menu ("Flash" Icon), Flashers tested are all Flash Lamps located between Q1-Q32 (This Game: Q14, Q23 & Q25-Q27, Q29-Q32)									
Auxiliary (UK ONLY)		Drive Transistor	Driver Output Board	Power Line Color	Power Line Connection	Power Voltage	Drive Transistor Control Line Color	D.T. Control Line Connect	Coil GA-Turn
	AUX 1: LEFT UP/DOWN POST	Q1	Solenoid Expander Auxiliary	BRN	J7-P1	20v DC	WHT	CN2-P5	26-1200 ♂ 090-5044-00T
	AUX 2: CENTER UP/DOWN POST	Q2		BRN	J7-P1	20v DC	RED	CN2-P4	23-1100 ♂ 090-5030-00T
	AUX 3: RIGHT UP/DOWN POST	Q3		BRN	J7-P1	20v DC	ORG	CN2-P3	26-1200 ♂ 090-5044-00T

♂ Coil Note: ♂ Either -00B or -00T can be used for coil replacements. B/T listed is preferable for easier diode access & may differ on game.

Sec. 5: Schematics...

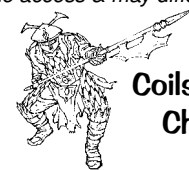

Backbox Wiring

Backbox I/O Power Driver Board Detailed Wiring Diagram

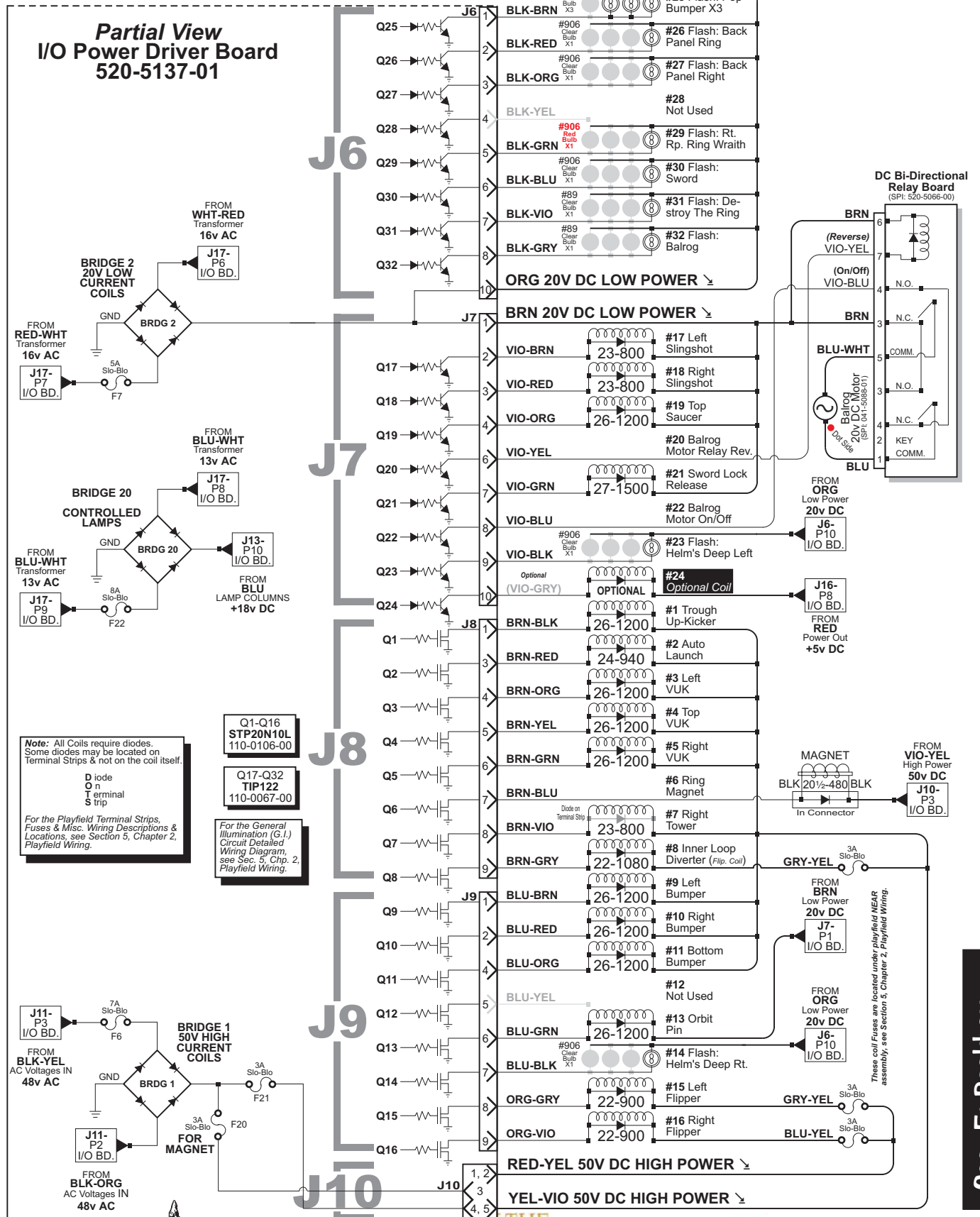

Backbox Board Layout Wiring Diagram

See Section 5, Chapter 4, Printed Circuit Boards (PCBs), Pages 145-150, for UK & Special Application(s) 3X Transistor Driver Board and ToPS™ Overview & Wiring, regarding the use of J2 & J3.

J3 ONLY used if UK GAME (Aux. Driver Bd. Required) or if ToPS™ Kit is installed, Tournament Serial Interface (TSI) Board required. or if Printer Interface Board is used (see Sec. 5, Chp. 3, Cabinet/Coin Door Wiring Diagram, bottom right corner).

J2 I/O to under Playfield Connector for 19-LED Board (Rings)..

Move Conn. J2 to J4 on TSI Bd. if ToPS™ Kit installed, then connect the Tournament Connector from J1 on TSI Bd. to J2 I/O Board.

Note: If the Printer Interface Board is used, the Dot Display or Tournament Wiring must be disconnected from J2 and/or J3.

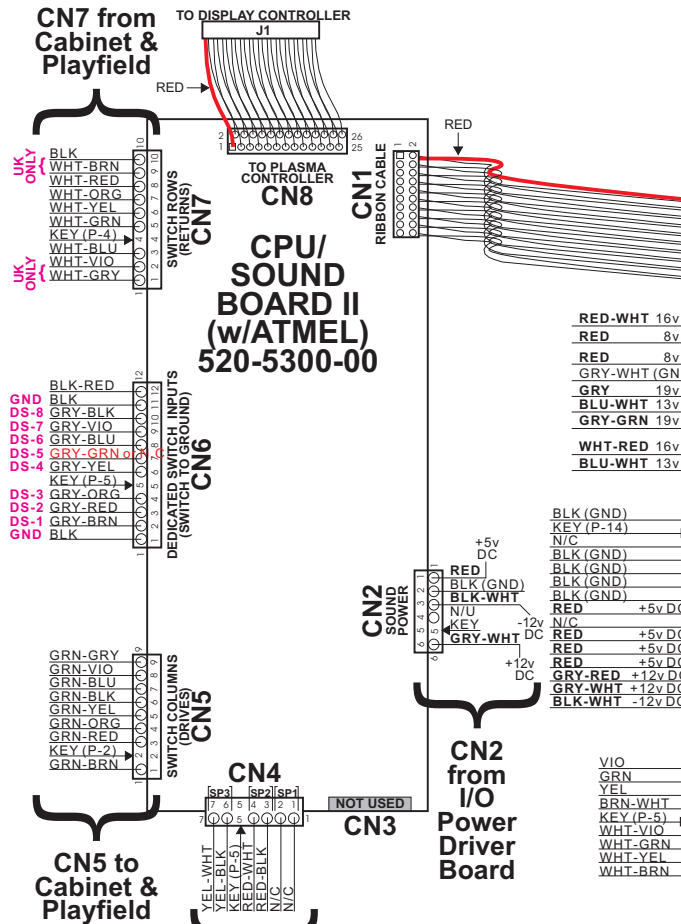

Important: When connecting any Ribbon Cable, always ensure the "Red Line" side of the ribbon cable goes to the Pin-1 side of any Dual 0.1" Header Connector.

Sec. 5: Backbox ...

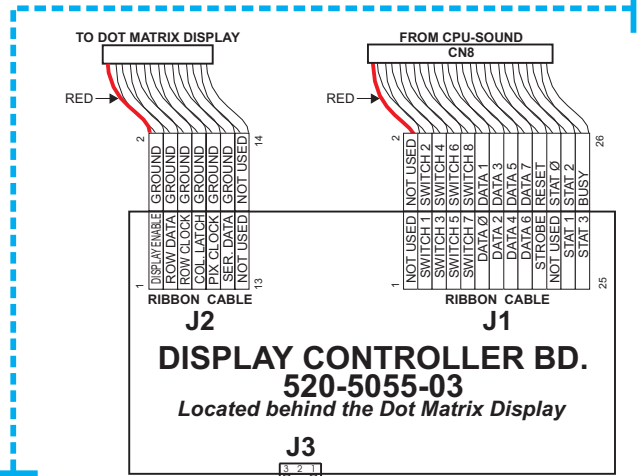
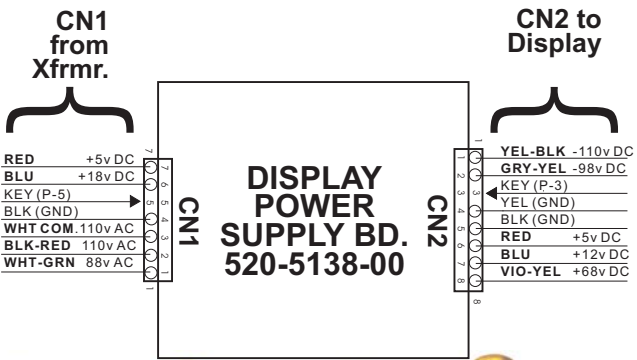

Playfield Wiring

General Illumination Circuit Detailed Wiring Diagram

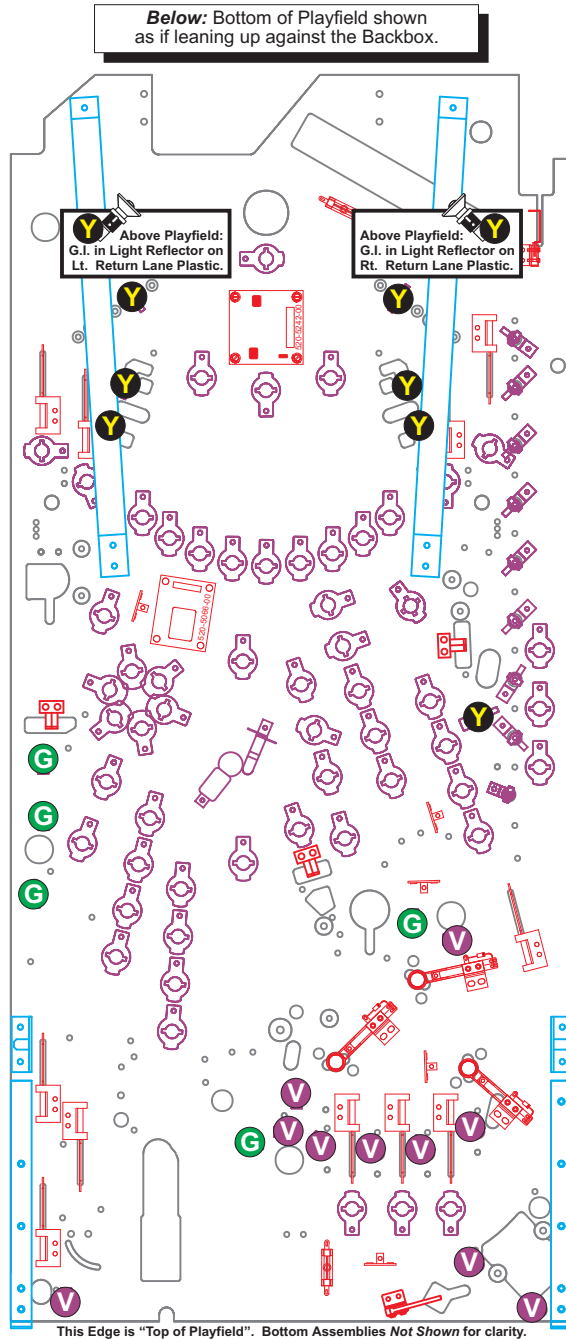

Below: Located at the top of the P/F, rear view of the Back Panel.

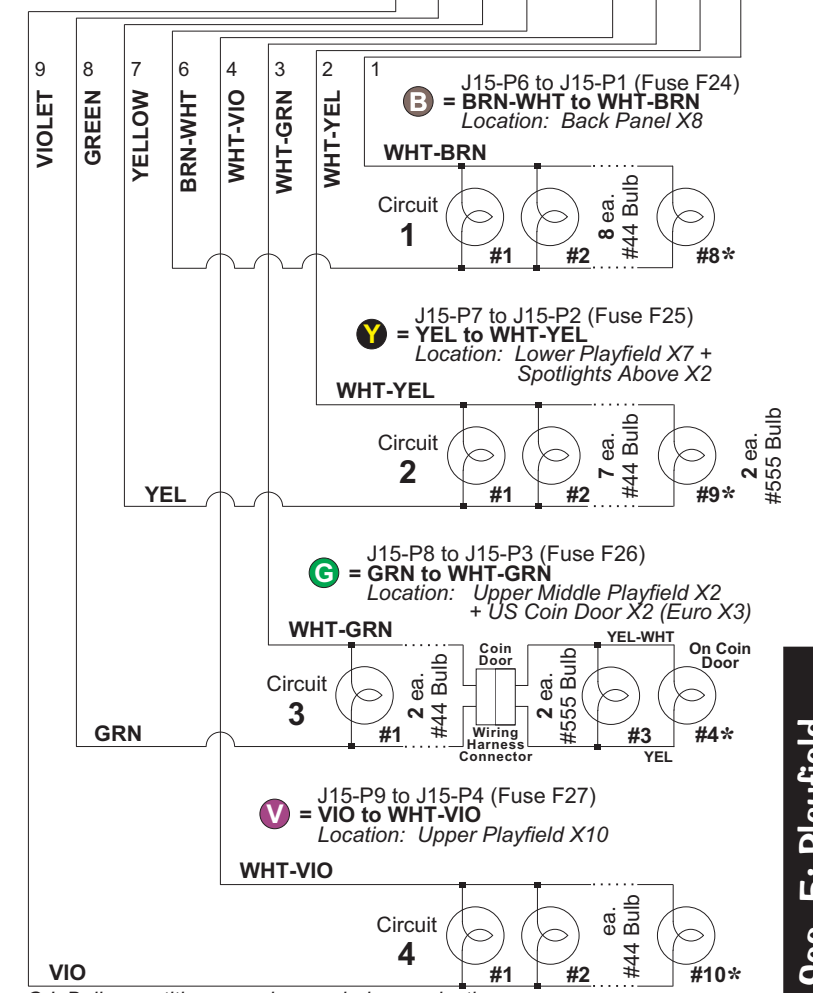
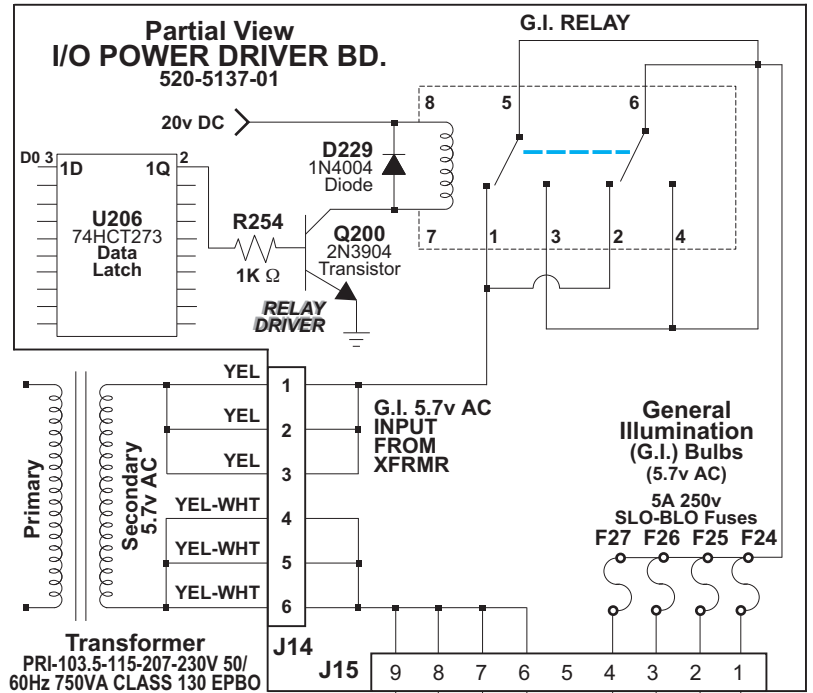
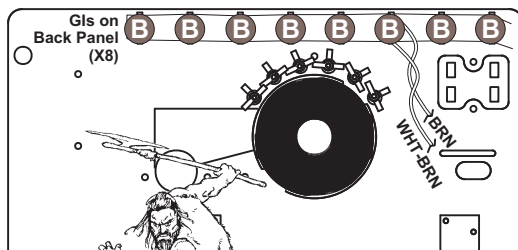

* G.I. Bulb quantities may change during production.

Sec. 5: Playfield ...

Playfield Switch Wiring Diagram

Note: All Switch, Lamp & Coil assemblies require diodes. Some diodes are located under the playfield on Terminal Strips or Diode Boards and not on the assemblies.

For Switch(es): 9, 25 & 30

Diode On Terminal Strip

Diode On Diode Board

Switch Drive Transistor Source N# 2N3904

SWITCH DRIVE

Wire & Transistor

CN5 PIN

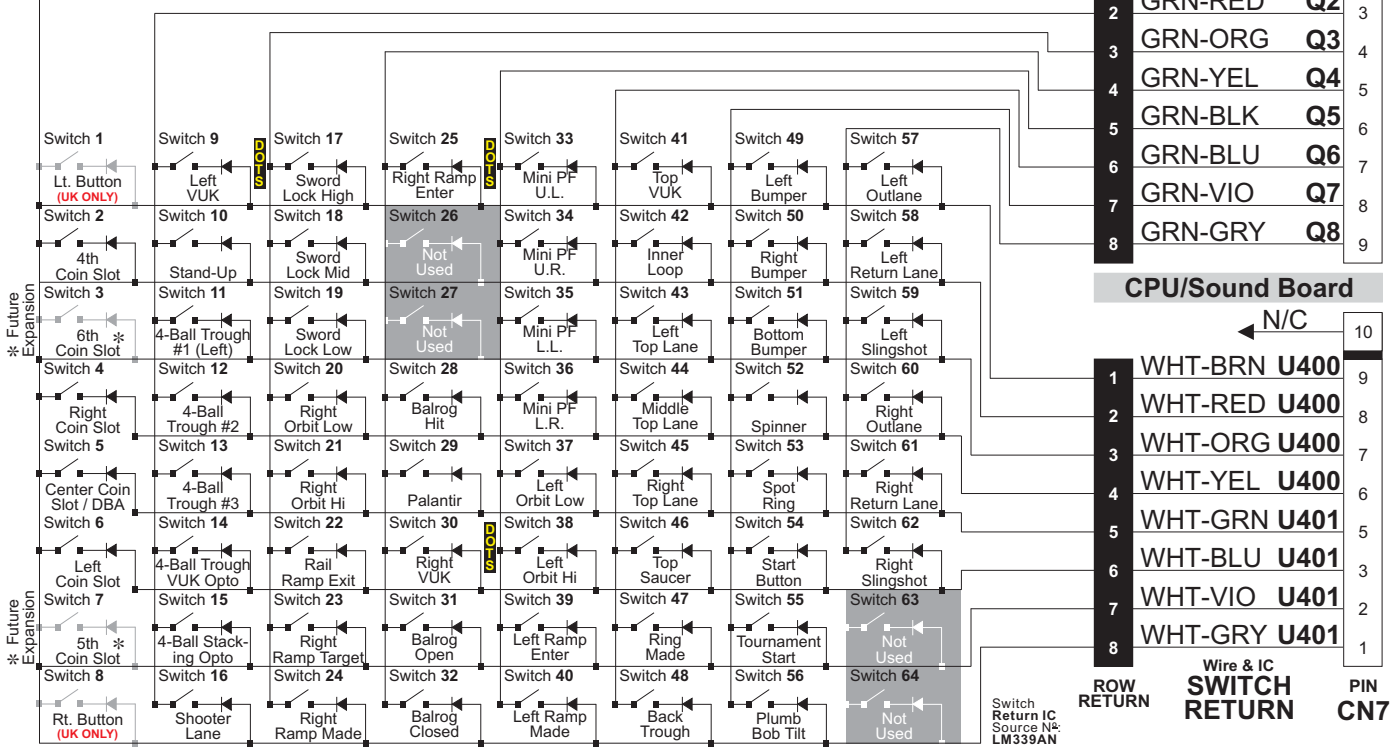

Playfield Lamp Wiring Diagram

Note: All Switch, Lamp & Coil assemblies require diodes. Some diodes are located under the playfield on Terminal Strips or Diode Boards and not on the assemblies.

For Lamp(s): N/A

Diode On Terminal Strip

Diode On Diode Board

J13-Pin 10 is Power Out for +18v DC to the Display Power Supply Bd at CN1-Pin 6

BLUE

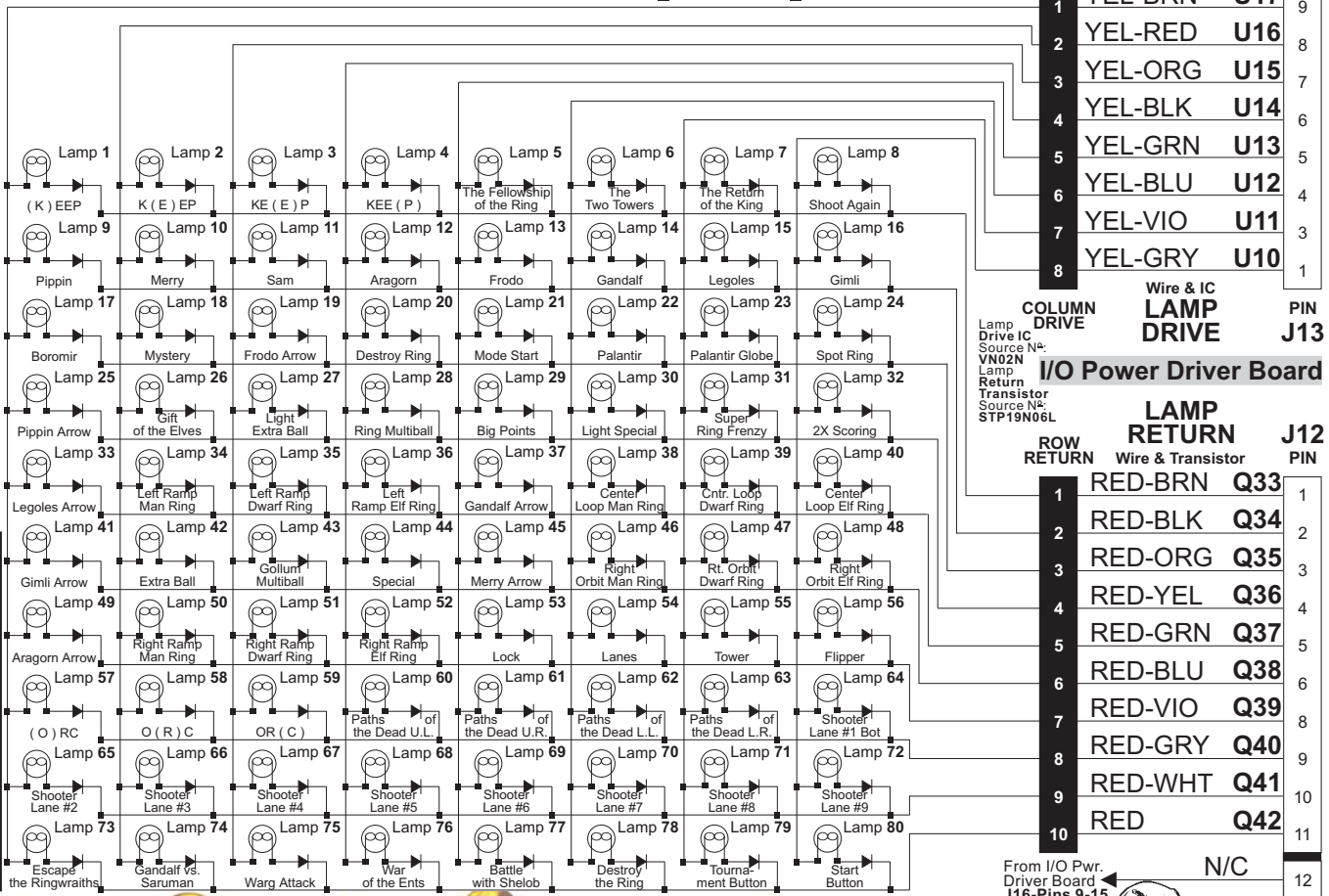

Sec. 5: Playfield ...



Playfield Terminal Strips, Fuses & Misc. Wiring Descriptions & Locations

Please Note: Terminal Strip(s), Diode Board(s) and/or Fuse Holder(s) locations shown, represent the general location (your game may differ slightly).

All fuses are rated:

3A 250v Slo-Blo
Do Not Over-Fuse

Bottom of Playfield
Shown as if leaning
up against the
Backbox.

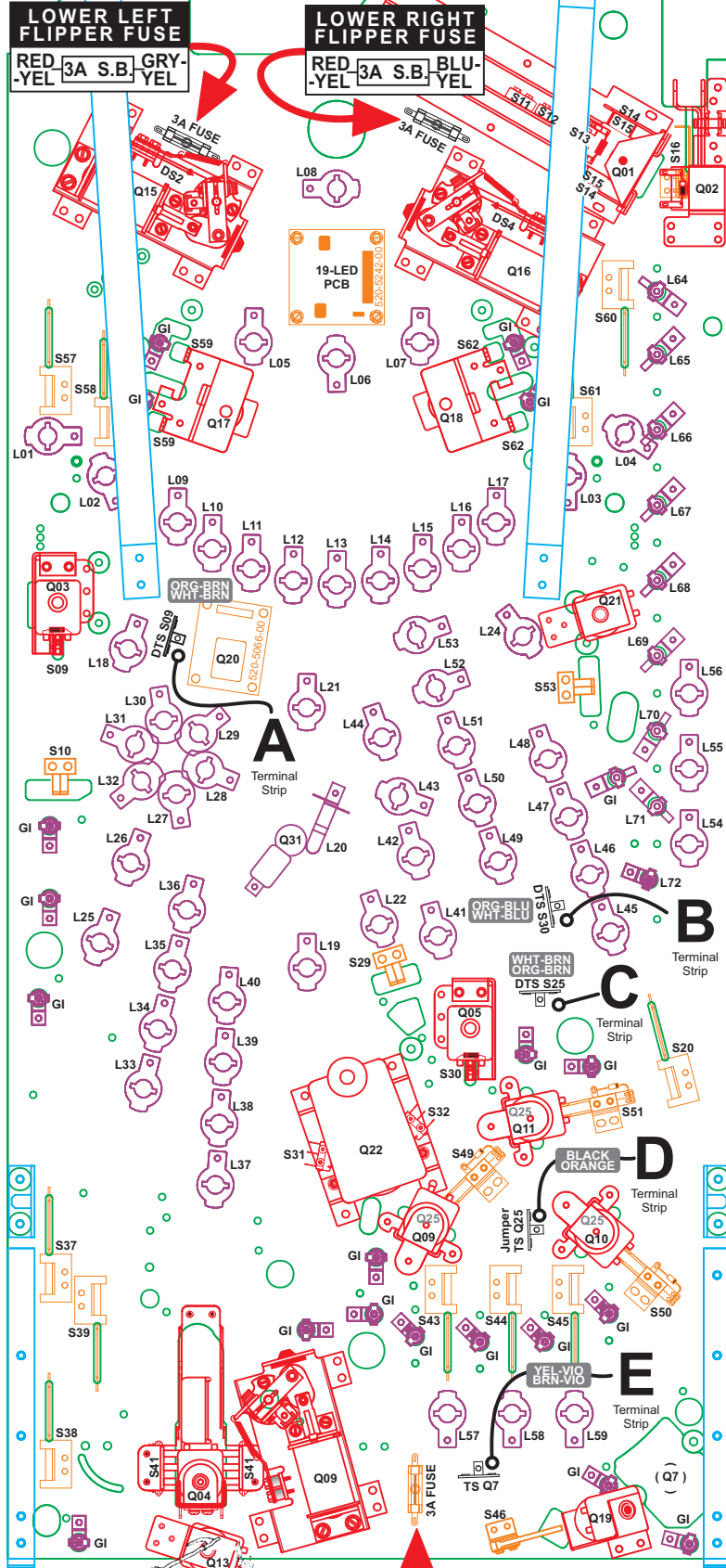

Explanation:

All Switch, Lamp & Coil assemblies require diodes. Some diodes are **located under the playfield** on Terminal Strips **or** Diode Boards and not on the assemblies. The Switch and Lamp Matrix Grids also note which Switch or Lamp has a diode on a Terminal Strip (noted by **"DOTS"** meaning: **"Diode On Terminal Strip"**) or on a Diode Board (noted by **"DODB"** meaning: **"Diode On Diode Board"**).

Legend:

S = Switch Matrix Number (Below P/F Only)

L = Lamp Matrix Number (Below P/F Only)

Q = Coil / Flash (see Page 101)

DTS / TS = (Diode) Terminal Strips (A-E)

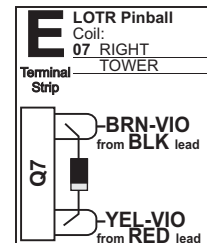
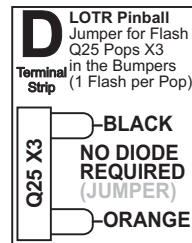
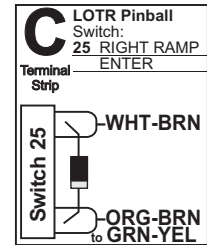
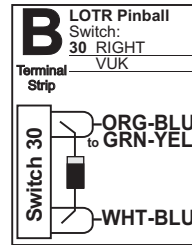
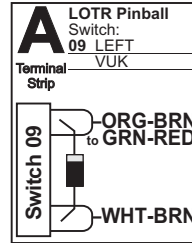

Playfield
Wiring



LOOP DIVERTER FUSE
YEL-VIO 3A S.B. GRN-YEL

See the Pink Pages, Playfield - General Parts & Switches (Below) (Pg. 66) for Terminal Strips, Diodes, Fuses and Fuse Holders Part Numbers.

2-Flipper Circuit Wiring Diagram

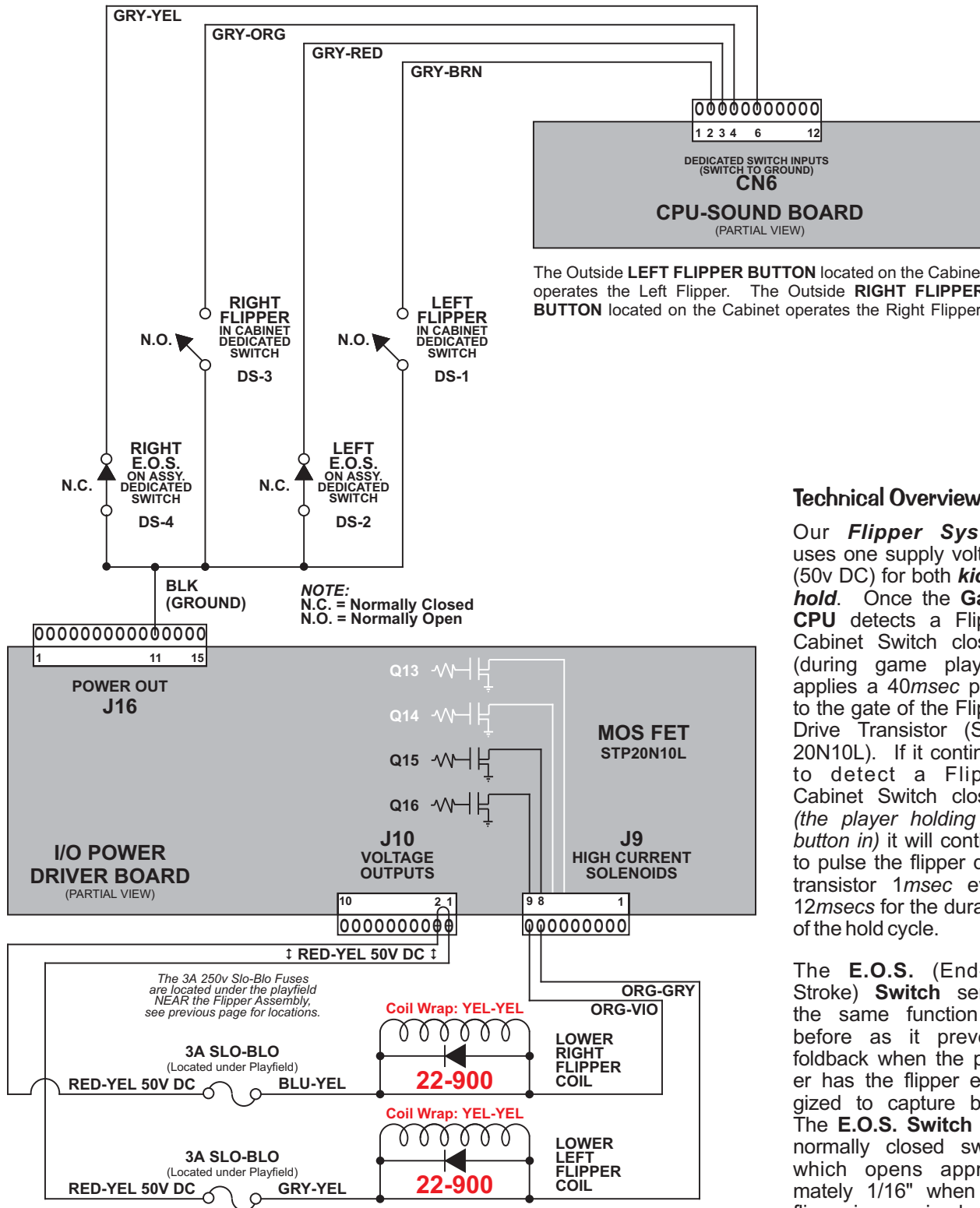

Technical Overview

Our **Flipper System** uses one supply voltage (50v DC) for both **kick & hold**. Once the **Game CPU** detects a Flipper Cabinet Switch closure (during game play) it applies a 40msec pulse to the gate of the Flipper Drive Transistor (STP-20N10L). If it continues to detect a Flipper Cabinet Switch closure (the player holding the button in) it will continue to pulse the flipper drive transistor 1msec every 12msecs for the duration of the hold cycle.

The **E.O.S.** (End-Of-Stroke) **Switch** serves the same function as before as it prevents foldback when the player has the flipper energized to capture balls. The **E.O.S. Switch** is a normally closed switch which opens approximately 1/16" when the flipper is energized. The **Game CPU** will detect a switch closure if the flipper bat is forced back by a high velocity shot or rebound on the playfield and will apply another 40msec pulse of 50v DC to the coil.

Sec. 5: Playfield ...

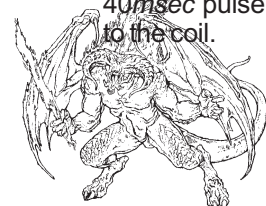

Cabinet Wiring

Transformer Power Wiring Diagram

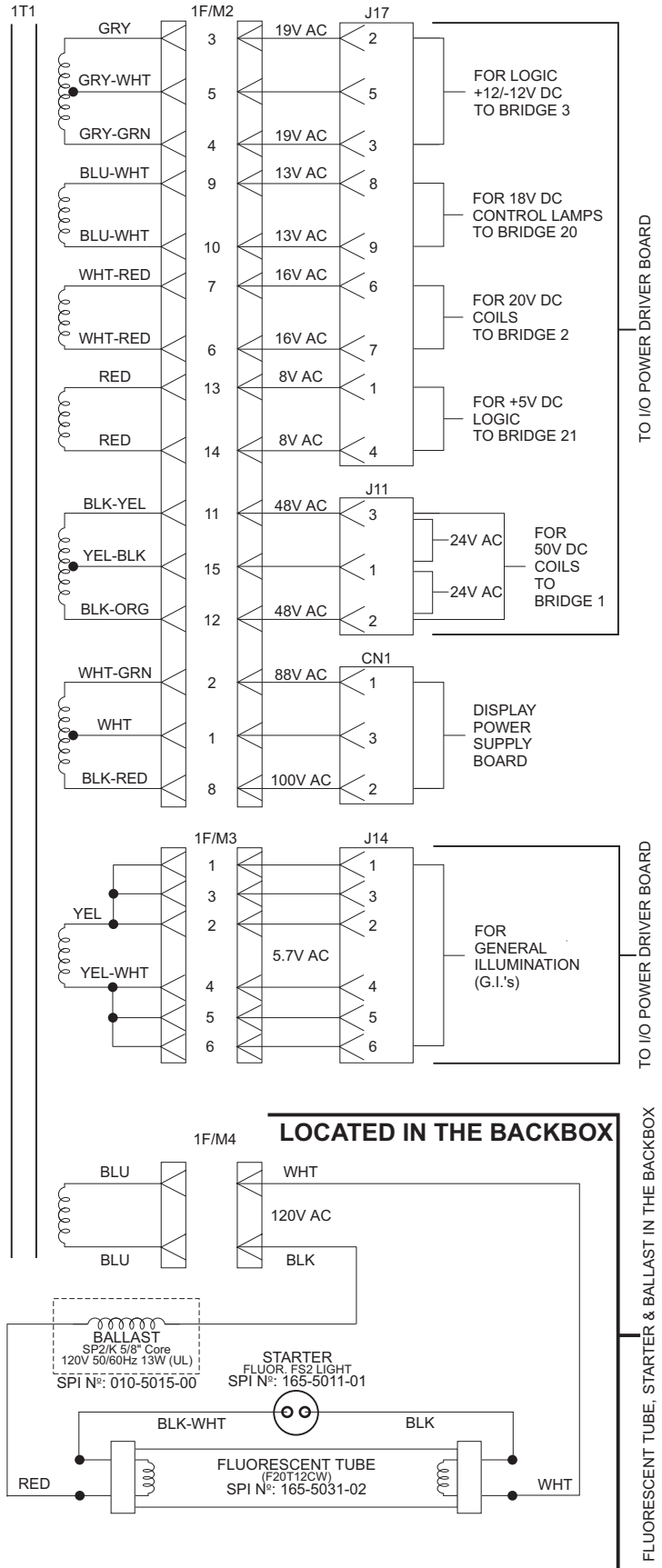
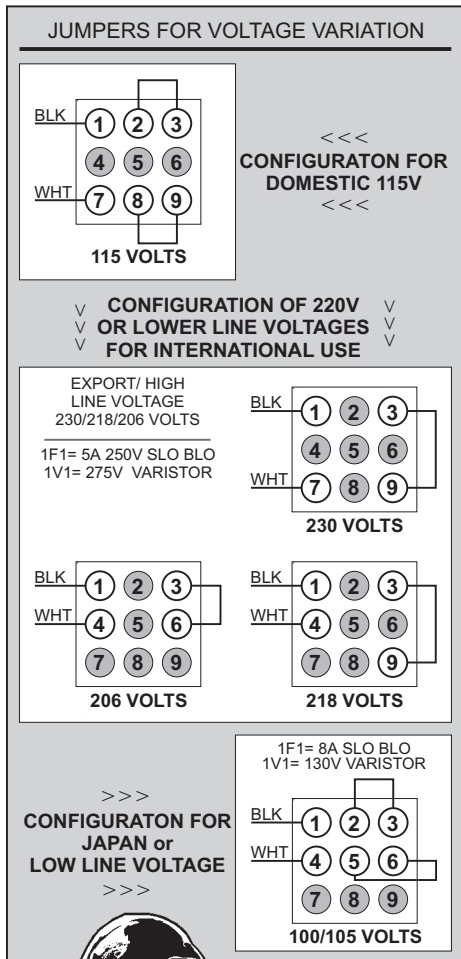
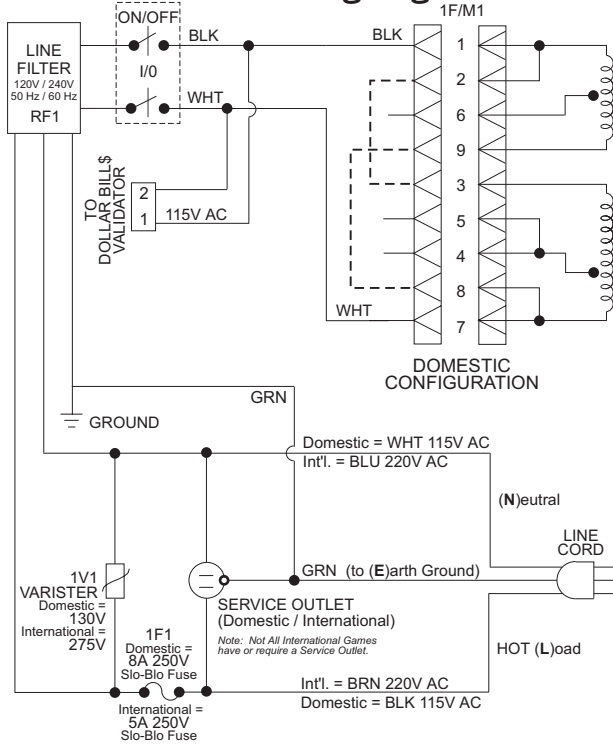

Cabinet Wiring



Cabinet / Coin Door Wiring Diagram

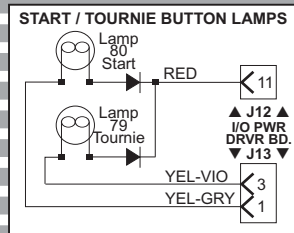
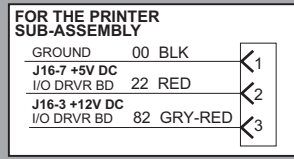
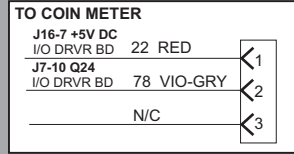
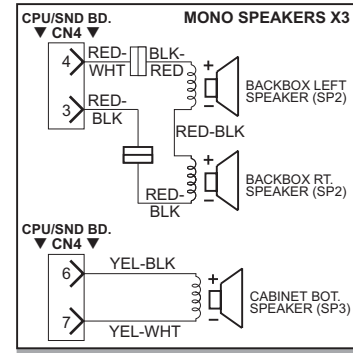
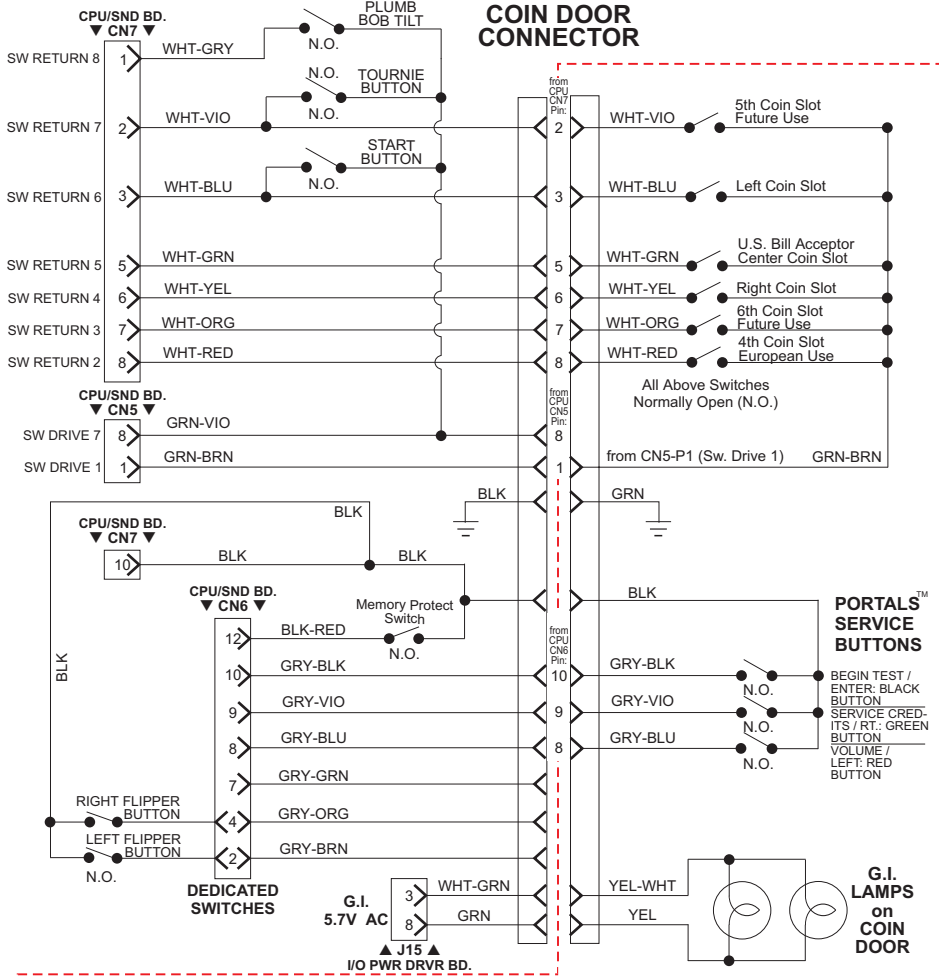

UK ONLY: 2 Extra Cabinet Buttons for the Post Save™ Feature are used. The Left Button operates the Left Outlane Ball Deflector. The Right Button operates the Right Outlane Ball Deflector. Both buttons pushed together operate the Center Up/Down Post. Both buttons are located under the Flipper Buttons.

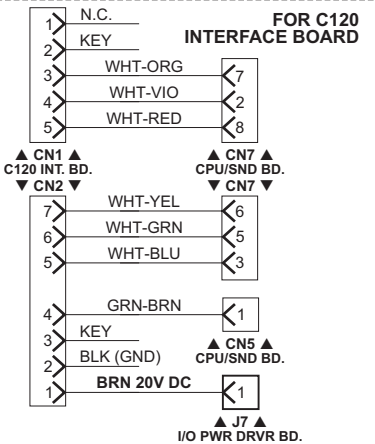
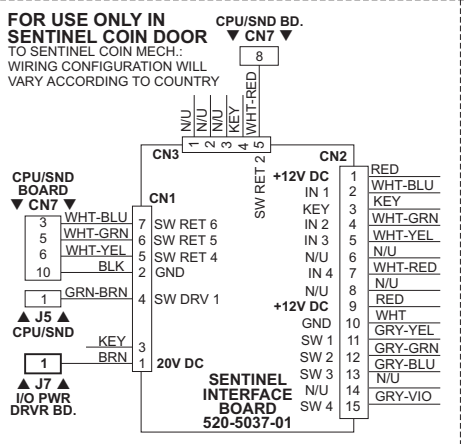
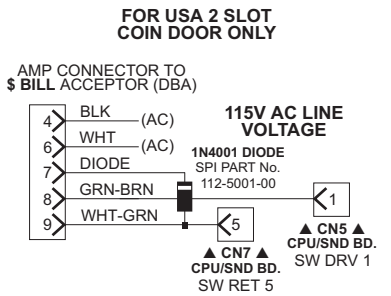
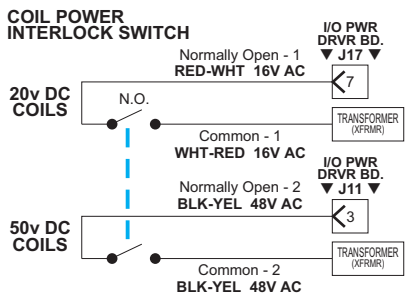
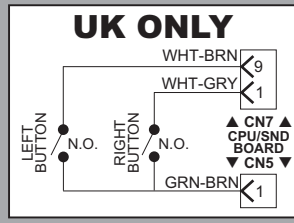

PRINTER INTERFACE OPTIONAL

Cable Wiring Harness SPI Part N°:
 036-5408-00
 RS-232 Printer Interface Board SPI Part N°:
 520-5069-00

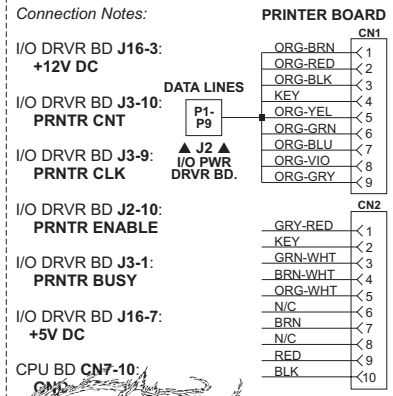

Sec. 5: Cabinet ...

COIN DOOR

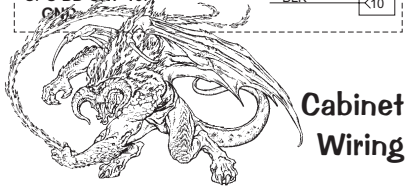

Printed Circuit Boards (PCBs)

Trough Up-Kicker Dual OPTO Boards Theory of Operation & Schematic

As light from the **Transmitter LED1** falls on the **Receiver LED1**, it generates a Positive Bias Voltage (0.7v to 1.5v) which is applied to the **Gate (G)** of **Q1 (Fet 2N5460)** turning **Q1** off. When **Q1** is held off, no current flows through **Q2's (2N3906) Base (B)**. With no *base current*, **Q2** is off and acts as an **OPEN SWITCH**. When the light is interrupted (**BLOCKED**) **R1 (Rec. Bd.)** bleeds the gate voltage off of **Q1** allowing it to conduct, switching **Q2** on, which acts as a **CLOSED SWITCH**. The **LED2 (Trans/Rec) Circuit** operates identical as the **LED1 Circuit**.

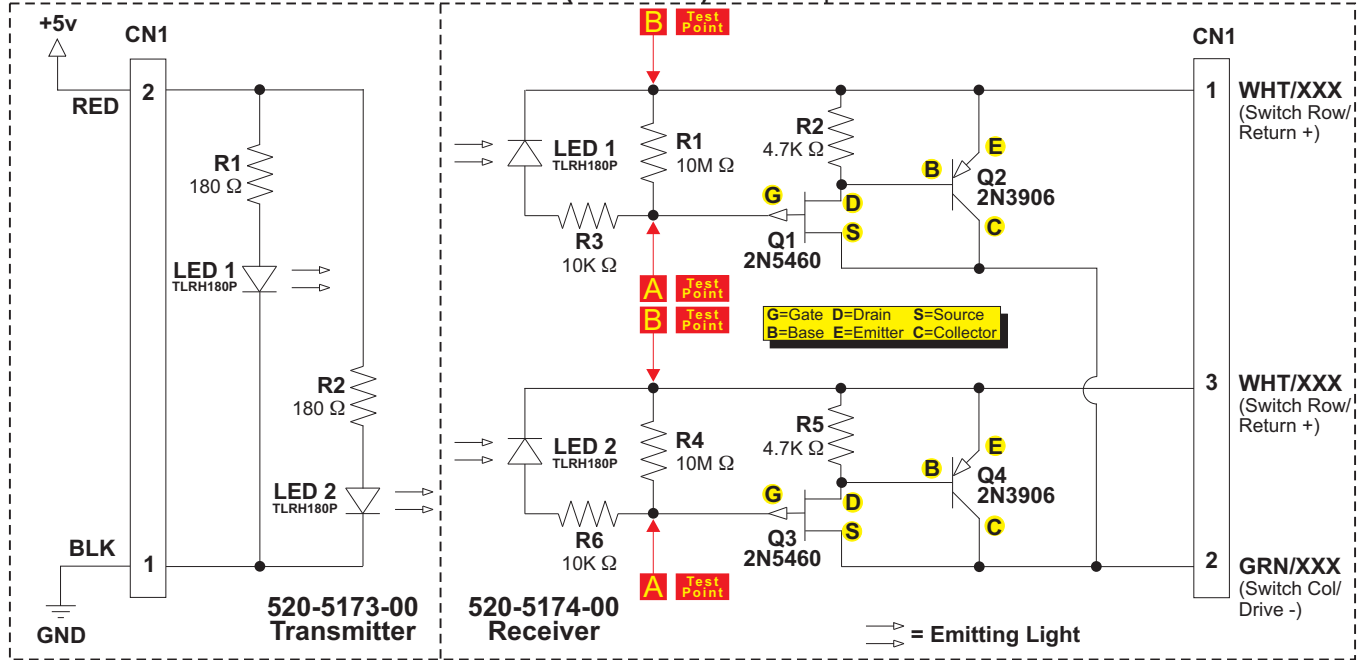

Trough Up-Kicker Dual OPTO Boards Component Layout & Parts

520-5173-00 (TRANS)

Boards Actual Size
(Screened Text Printed Larger for Clarity)

520-5174-00 (REC)

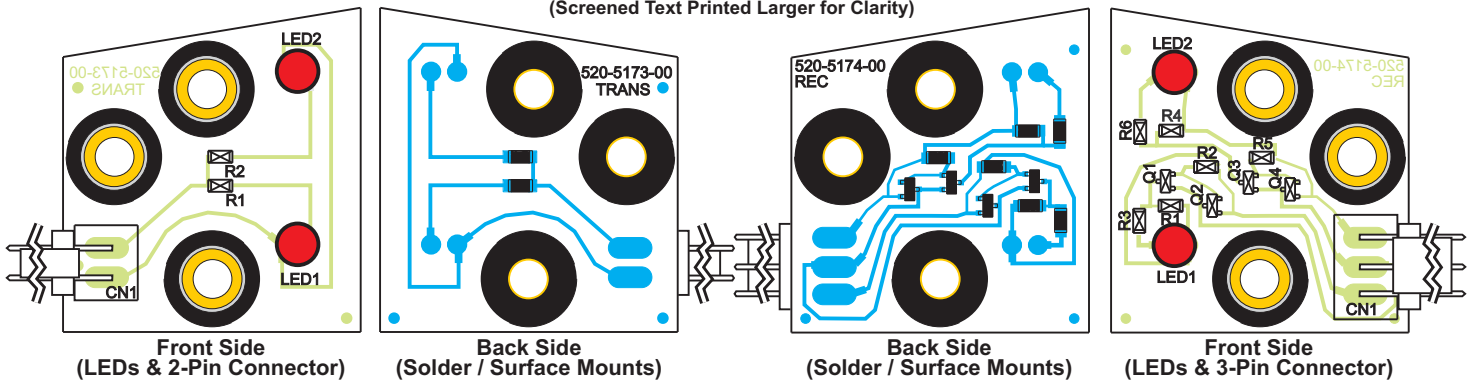

ITEM	QTY	PART NUMBER	REF-DESIGNATOR	DESCRIPTION
A	1	515-0173-00	Dual-OPTO Trans. Bd. Assy.	PCB Assy. (with all Items 1-5) PCB Assy. (with Items 1-3 only) 2X, .156" Rt. Angle (26-60-5020) Conn. LED TLRH180P (Ultra Bright Red) 180 Ω 1/8W Chip Res. (CRCW) OPTO PCB Brass Tube Spacer OPTO PCB Rubber Grommet
—	1	520-5173-00	Dual-OPTO Trans. Board	
01	1	045-5111-02	CN1	
02	2	165-5052-00	LED1, LED2	
03	2	121-5067-00	R1, R2	
04	3	530-5308-02	n/a	
05	3	545-5518-00	n/a	
B	1	515-0174-00	Dual-OPTO Rec. Bd. Assy.	
—	1	520-5174-00	Dual-OPTO Rec. Board	
01	1	045-5111-03	CN1	PCB Assy. (with all Items 1-9) PCB Assy. (with Items 1-7 only) 3X, .156" Rt. Angle (26-60-5030) Conn. LED TLRH180P (Ultra Bright Red) 2N5460, Transistor (P-FET SOT-23) 2N3906 , Transistor 10M Ω 1/8W Chip Res. (CRCW) 4.7K Ω 1/8W Chip Res. (CRCW) 10K Ω 1/8W Chip Res. (CRCW) OPTO PCB Brass Tube Spacer OPTO PCB Rubber Grommet
02	2	165-5052-00	LED 1, LED 2	
03	2	110-5006-00	Q1, Q3	
04	2	110-0086-00	Q2, Q4	
05	2	121-5082-00	R1, R4	
06	2	121-5083-00	R2, R5	
07	2	121-5011-00	R3, R6	
08	3	530-5308-02	n/a	
09	3	545-5518-00	n/a	

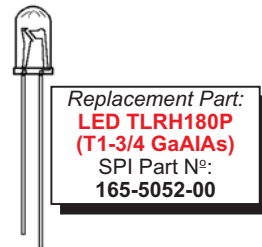

OPTO Troubleshooting

1. Volt Meter Test (indicates normal operating condition):

A. **OPEN OPTO** (Light Falling on LED) = *SWITCH OPEN*. Place meter leads across points **A** and **B** on the **LED1 Circuit** (Refer to Schematic Drawing on previous page, 520-5174-00 Receiver Side). It should read approximately 0.8 - 1.2v DC. The **LED2 Circuit** operates the same.

B. **CLOSED OPTO** (Light Blocked) = *SWITCH CLOSED*. Place meter leads across points **A** and **B** on the **LED1 Circuit** (Refer to Schematic Drawing on previous page, 520-5174-00 Receiver Side). It should read approximately 0.0 - 0.1v DC. The **LED2 Circuit** operates the same.

2. Oscilloscope Test (indicates normal operating condition):

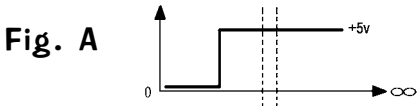

A. **OPEN OPTO** (Light Falling on LED) = *SWITCH OPEN*. Place Scope lead at **Pin-1** of OPTO Rec. Board with Scope Grounded (see Schematic). The Scope should display a **STEADY +5v** as shown in **Fig. A**, Wave Form Diagram.

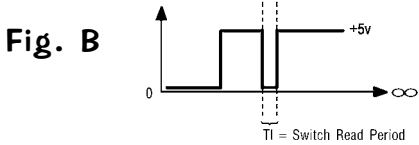

B. **CLOSED OPTO** (Light Blocked) = *SWITCH CLOSED*. Place Scope lead at **Pin-1** of OPTO Rec. Board with Scope Grounded (see Schematic). The Scope should display a **PULSE STREAM** indicating **Q2** has switched "On" as shown in **Fig. B**, Wave Form Diagram. This is your Switch Drive Pulse.

3. Bench Test (See Fig. C):

Please Note: To perform this test you must use a spare 560Ω Pull-Up Resistor, SPI N^o: 121-5047-00

Disconnect the **OPTO Transmitter / Receiver Board** from the circuit. Connect one side of a 560Ω Pull-Up Resistor to **Pin-1** of the OPTO Receiver Bd. and the other side of the resistor to a 5v DC source. Connect **Pin-2** to GND. Connect a +5v DC source to **Pin-1** of the Transmitter & GND to **Pin-2**. Align with the Receiver OPTO approx. 3" distance. Using your Volt-Meter or an Oscilloscope, monitor **Pin-1** while **BLOCKING** and **UNBLOCKING** the **BEAM** from the Trans. The output will be approx. +5v DC when the **BEAM IS NOT BLOCKED** and approx. 0v when the **BEAM IS BLOCKED**.

Fig. C

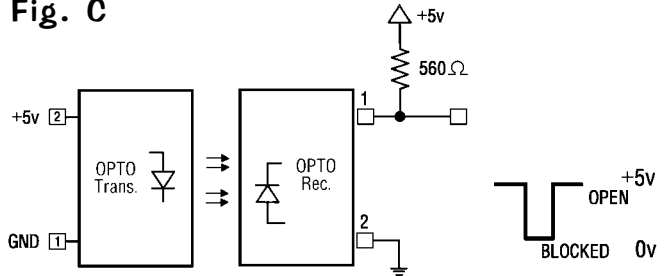

Trough Dual OPTO Boards Alignment / Test for LED1

When a working **OPTO** is installed and connected in a game, the transmitter should light (**LED1 lower & LED2 upper**) when the power is switched on. With the playfield in **Service Position #1** (playfield lifted up in the half-way position resting on the Prop Rod or edge slide support brackets) and the game on, the LED lights should show up as a **BRIGHT RED RINGS** through the back of the Receiver Board around the **Receivers LED1 & LED2** (See **Fig. 1**). Testing only **LED1**: With the game in **Switch Test Mode**, lifting the Trough Plunger with a fingertip should block the **BEAM** and cause the Switch Position to trigger (See **Fig. 2**). View **Fig. 2a & 2b** (on the next page) for a sectional view of the Light Path (note alignment) and what happens as a ball breaks the light beam.

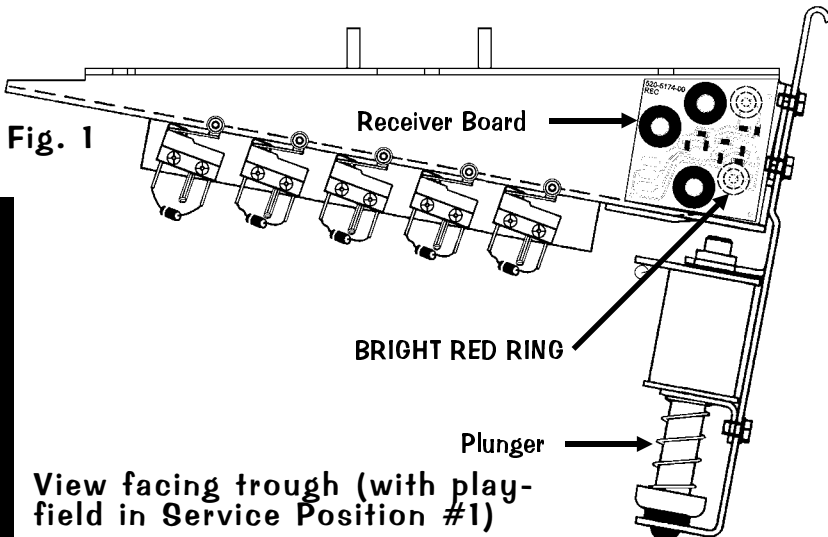

View facing trough (with playfield in Service Position #1)

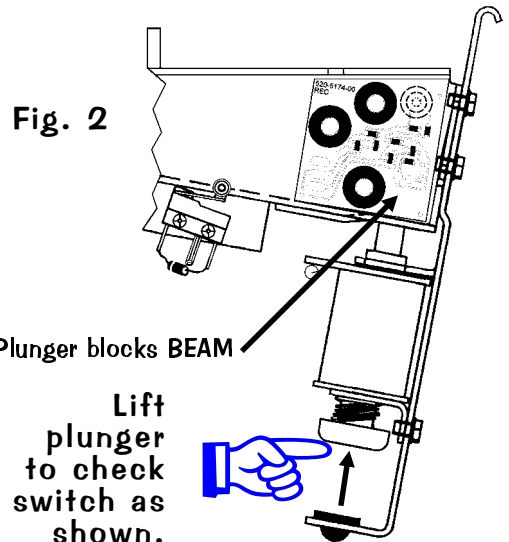

Sectional view from right (Fig. 2a & 2b)

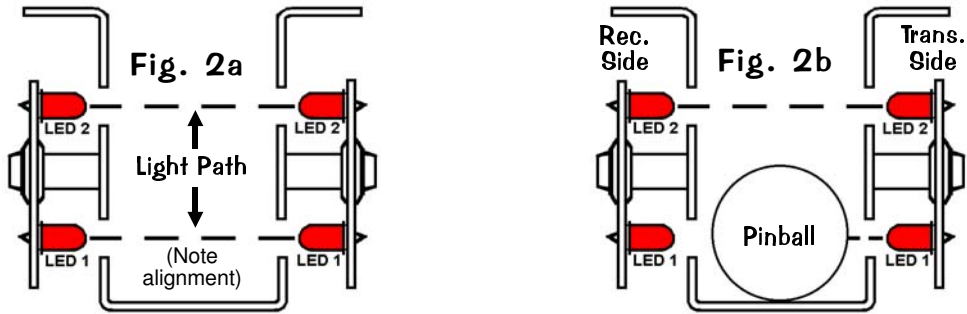

Trough Dual OPTO Boards Alignment / Test for LED2

When a working **OPTO** is installed and connected in a game, the transmitter should light (LED1 lower & LED2 upper) when the power is switched on. With the playfield in **Service Position #1** (playfield lifted up in the half-way position resting on the Prop Rod or edge slide support brackets) and the game on, the LED lights should show up as a **BRIGHT RED RINGS** through the back of the Receiver Board around the **Receivers LED1 & LED2** (See Fig. 1, previous page). Testing only **LED2**: *TO PERFORM THIS TEST, A PINBALL MUST BE IN THE BALL TROUGH.* With the game in **Switch Test Mode**, lifting the Trough Plunger with a finger tip should block the **BEAM** on LED2 and cause the Switch Position to trigger (See Fig. 3). View Fig. 3a & 3b for a sectional view of the Light Path (note alignment) and what happens as a "double-stacked" ball scenario breaks the light beam.

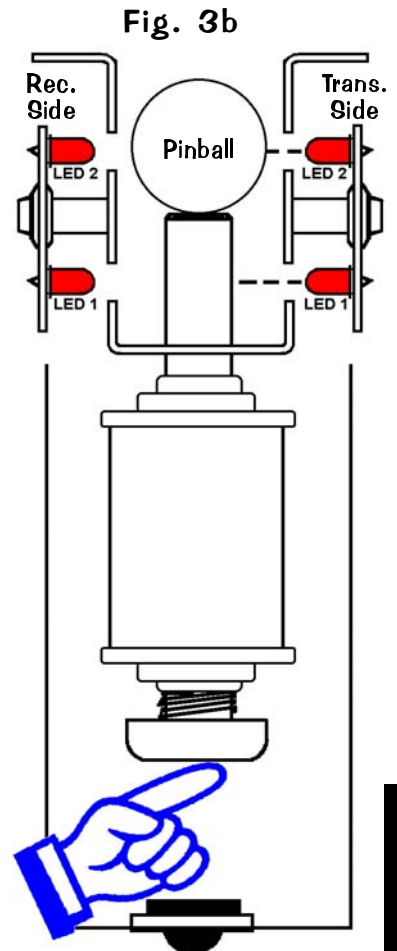
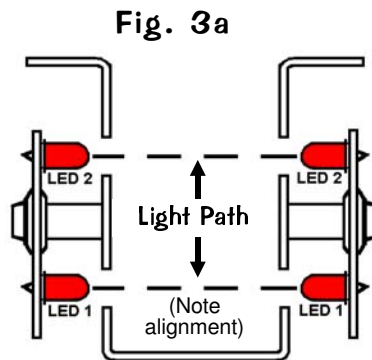
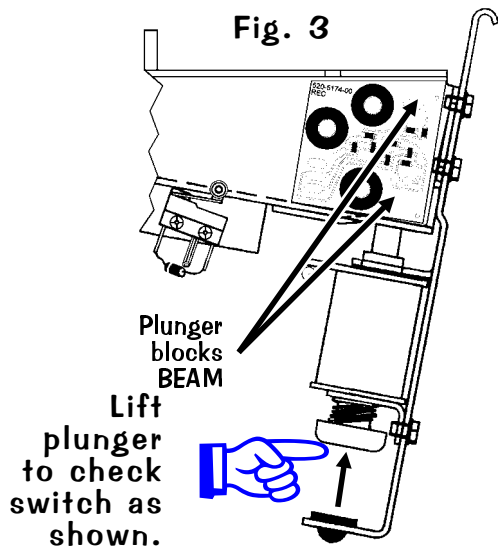

I M P O R T A N T

If replacement of **LED** is required, insure that is **mounted correctly before and after soldering** (See Fig. 4a / 4b).

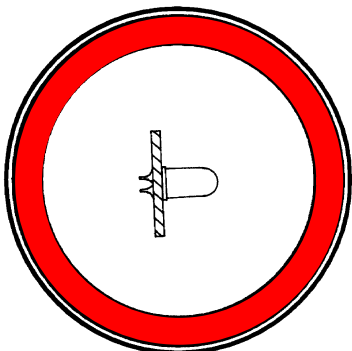

Fig. 4a
Correct Position

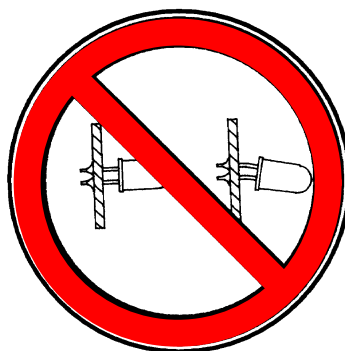
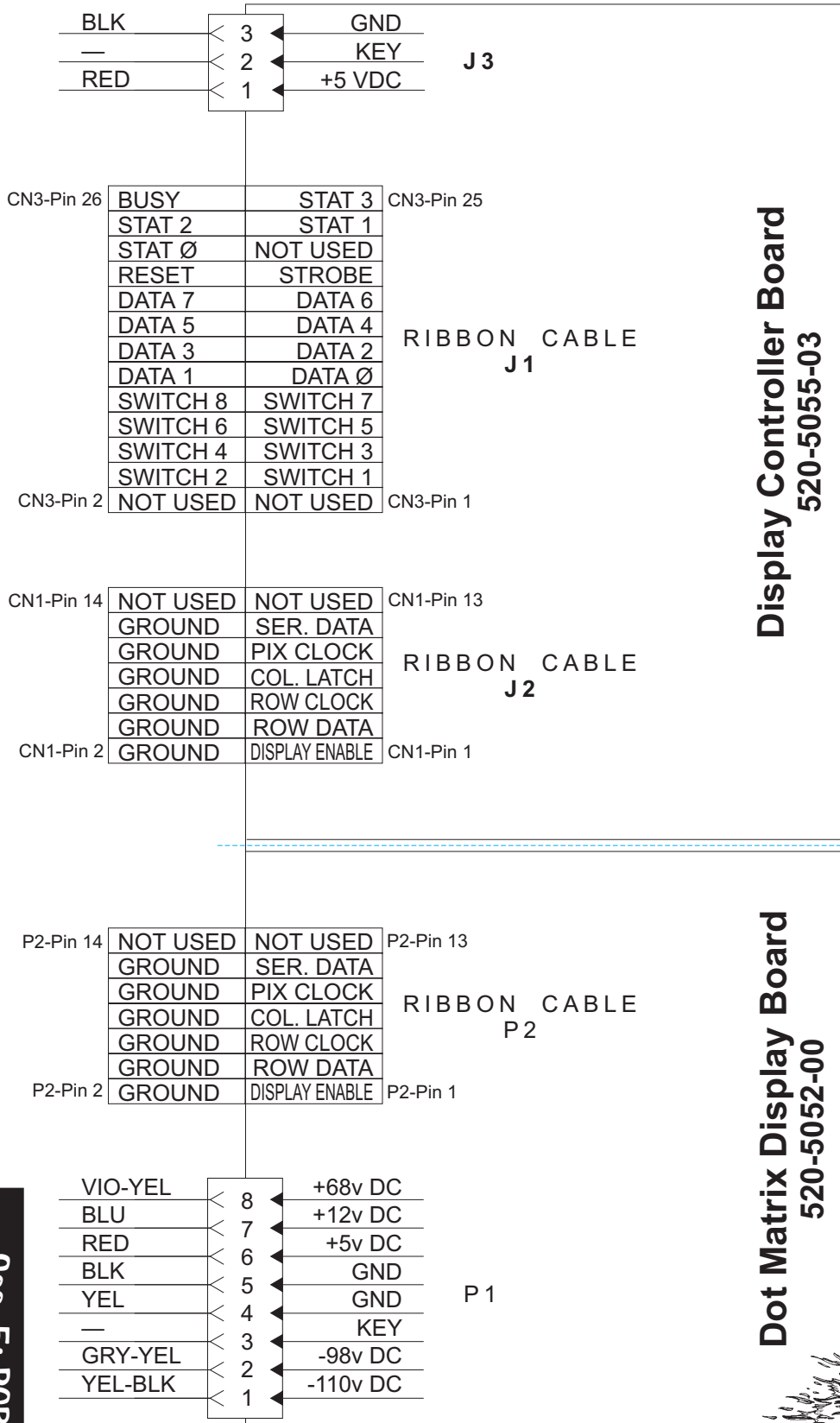

Fig. 4b
Incorrect Position



Dot Matrix Display / Display Controller Bd. Combined Display Connections



Display Controller Board
520-5055-03

Dot Matrix Display Board
520-5052-00

Dot Matrix Display Explained

The display utilizes a Micro-Processor Control Board mounted in piggyback fashion to the Dot Matrix Display (128 X 32) Driver Board. The purpose behind this board is to provide more information to the operator as well as displaying graphics to the player.

The board is controlled by a 6809E Micro processor and its personality ROM (Unique to the Game). It receives Data, Reset & Clock Information from the CPU/Sound Board via the ribbon cable and sends back multiple Status and Busy Signals to the CPU. This is to insure synchronized communication between the CPU and the Display Controller Board. The Drivers for the rows and columns are provided on 5 surface mounted integrated circuits on the Dot Matrix Display Driver Board.

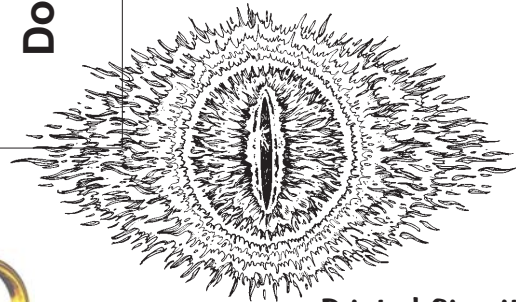

Printed Circuit Boards (PCBs)



Display Power Supply Board Schematic

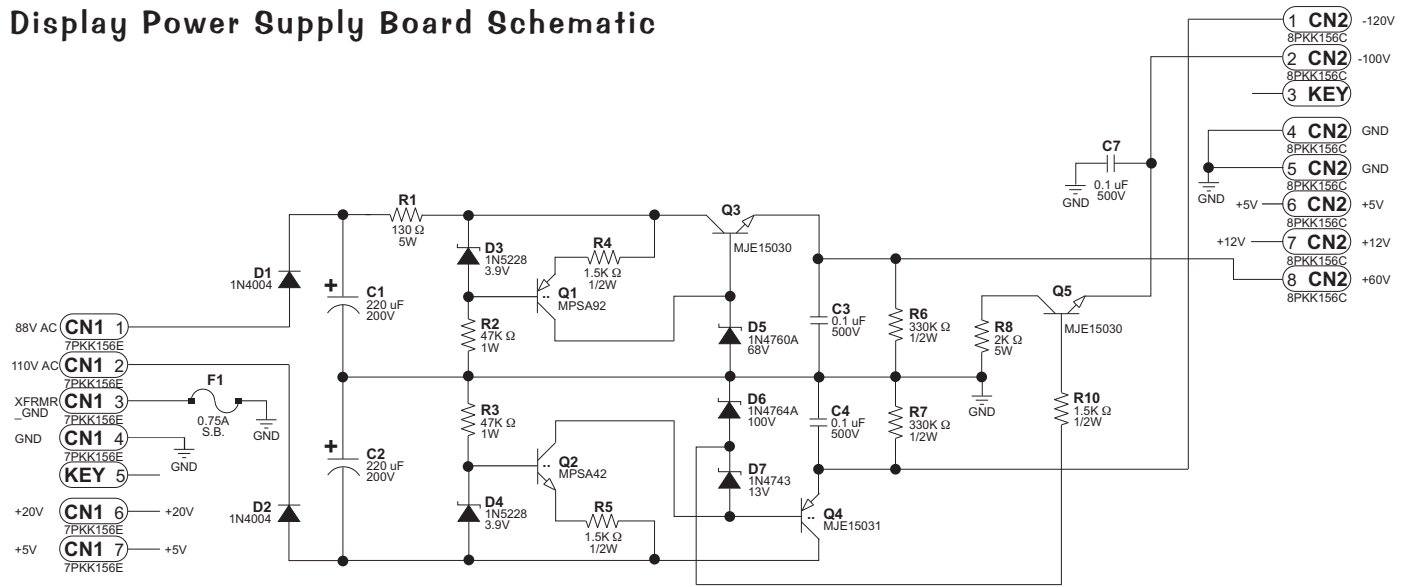

Display Power Supply Board Component Layout & Parts

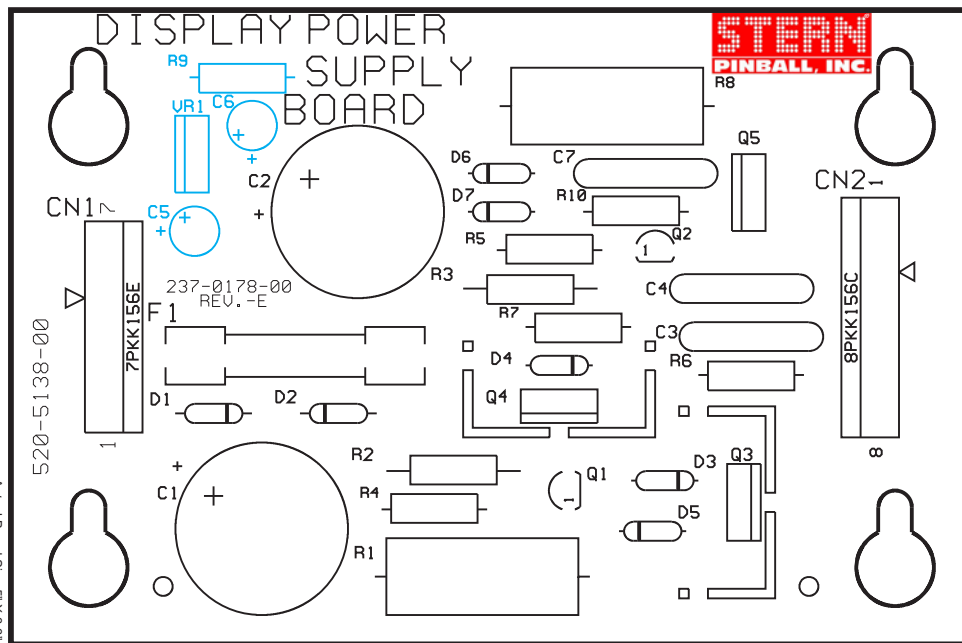

ITEM	QTY	PART NUMBER	REF-DESIGNATOR	DESCRIPTION (NS = Not Stuffed)
—	1	520-5138-00	Display Power Supply Board	Complete PCB Assembly
01	2	125-5044-00	C1, C2	220uF, 200v, Radial Lytic Cap.
02	3	125-5035-00	C3, C4, C7	0.1uF, 500v, Ceramic Disk Cap.
03	0	125-5003-00	(C5, C6: NS)	22uF, 35v, Rad Lytic Cap
04	1	045-5015-07	CN1	7PKK156E (PIN5=KEY)
05	1	045-5015-08	CN2	8PKK156 (PIN3=KEY)
06	2	112-5003-00	D1, D2	1N4004, Diode
07	2	112-0053-00	D3, D4	1N5228, 3.9v, Diode
08	1	112-0062-00	D5	1N4760A, 68v, Diode
09	1	112-0049-00A	D6	1N4764A, 100v, Diode
10	1	112-0061-00	D7	1N4743, 13v, Diode
11	1	200-5000-17	F1	3/4A (0.75A) S.B. Fuse
12	2	205-0004-00	F1	Fuse Clip
13	1	110-0100-00	Q1	MPSA92, Transistor
14	1	110-0082-00	Q2	MPSA42, Transistor
15	2	110-0101-00	Q3, Q5	MJE15030, Transistor
16	2	535-5000-11	Q3, Q4	Heatsinks - AAVID #563002
17	2	240-5008-00	Q3, Q4	#6-32 KEPS Nut
18	2	237-5501-00	Q3, Q4	#6-32 X 3/8" PPH Screw
19	1	110-0103-00	Q4	MJE15031, Transistor
20	1	121-5061-00	R1	130 Ω 5W Res.
21	2	121-5060-00	R2, R3	47K Ω 1W Res.
22	3	121-5038-00	R4, R5, R10	1.5K Ω 1/2W Res. (R9: NS)
23	2	121-5059-00	R6, R7	330K Ω 1/2W Res.
24	1	121-5062-00	R8	2K Ω 5W Res.
25	0	124-5003-00	(VR1: NS)	7812CT

Printed Circuit Boards (PCBs)



Sec. 5: PCBs

Display Controller Board Schematic

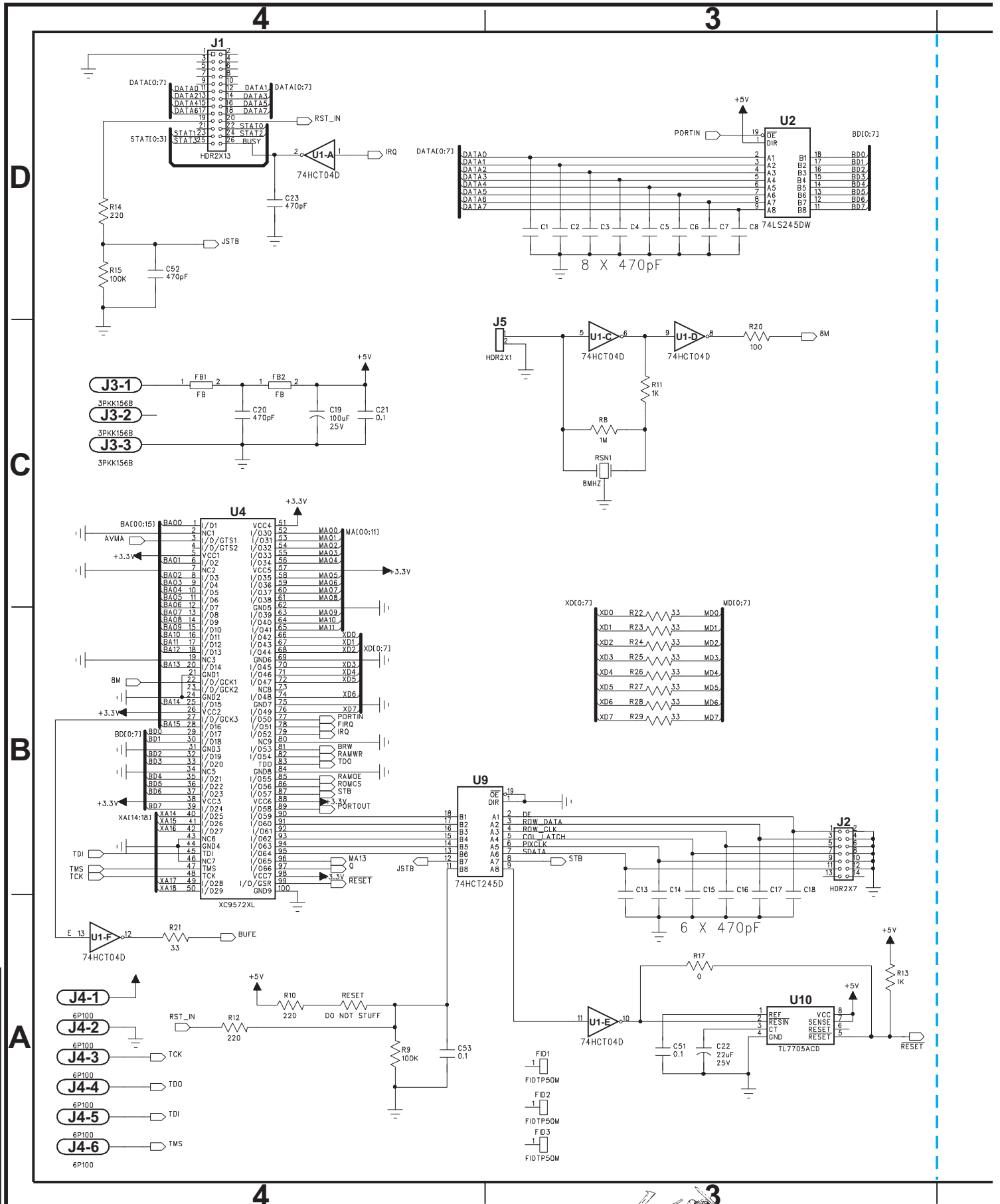

Sec. 5: PCBs



Display Controller Board Schematic

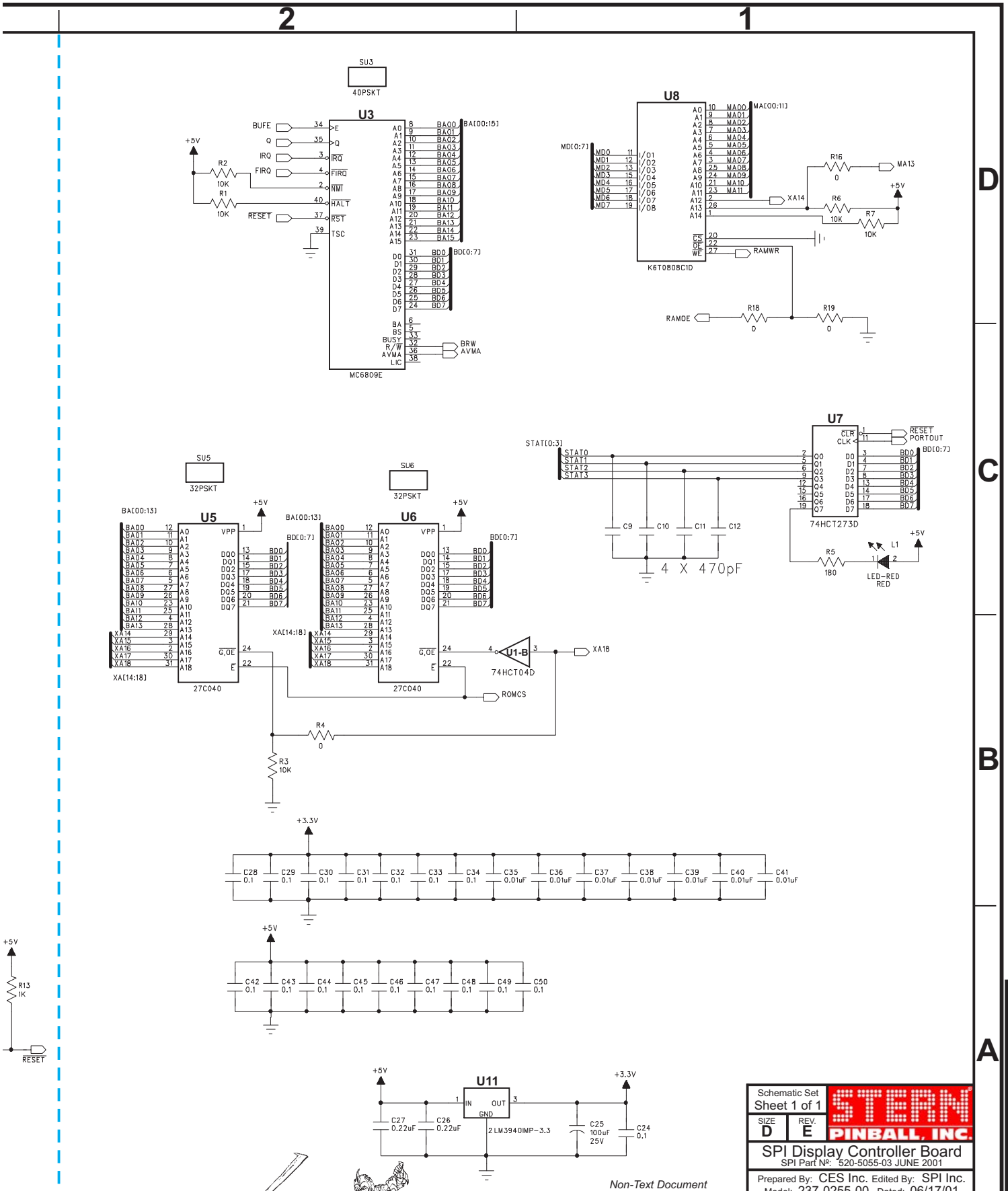

D
C
B
A

Sec. 5: PCBs

Schematic Set		STERN
Sheet 1 of 1		
SIZE	REV.	PINBALL, INC.
D	E	
SPI Display Controller Board		
SPI Part No: 520-5055-03 JUNE 2001		
Prepared By: CES Inc. Edited By: SPI Inc.		
Model: 237-0255-00 Dated: 06/17/01		

Non-Text Document



Display Controller Board Component Layout & Parts

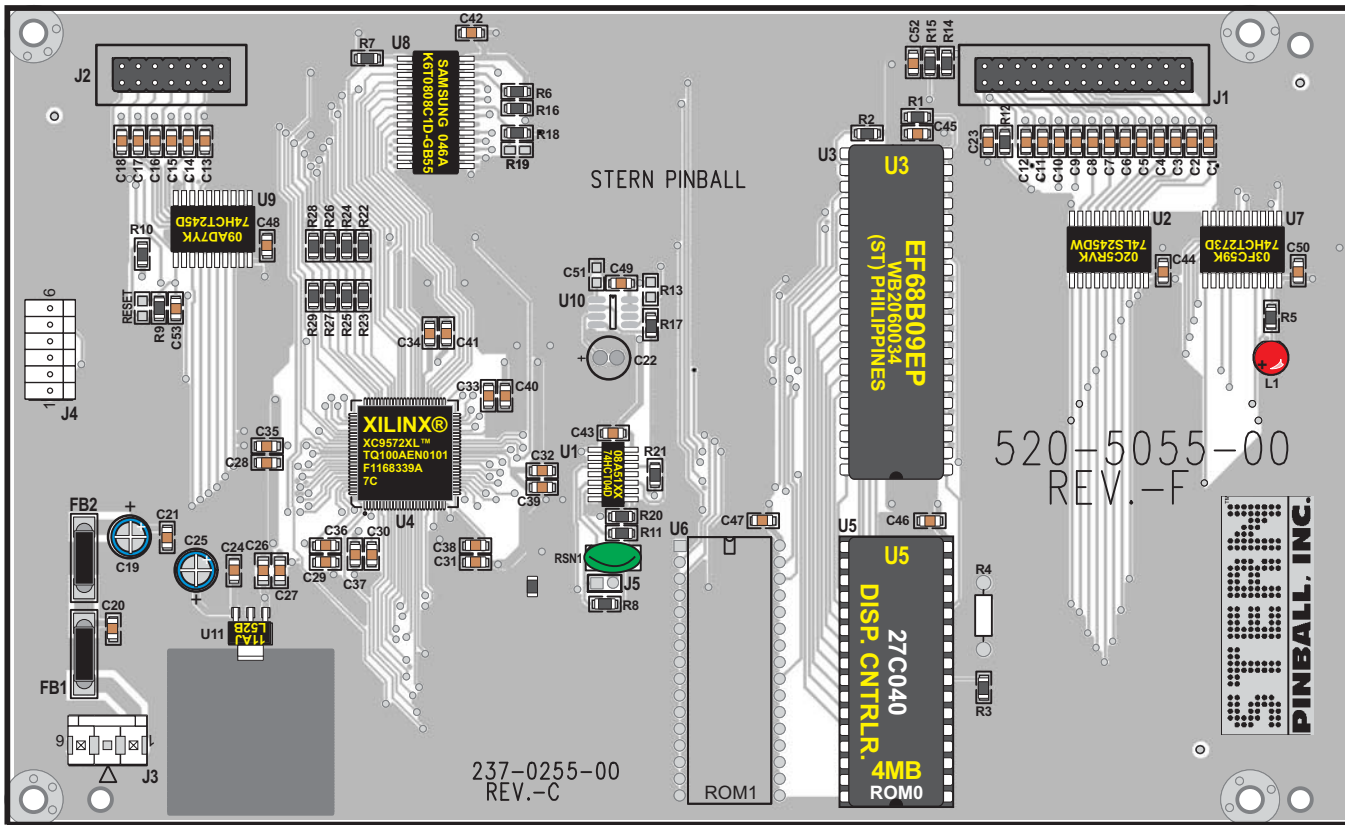

Actual Board Size 20.5cm X 12.5cm

ITEM	QTY	PART NUMBER	REF-DESIGNATOR	DESCRIPTION (NS = Not Stuffed)
—	1	520-5055-03	Display Controller Bd. (FCC FEB98) Rev. E June 2001	Complete PCB Assembly
01	1	045-5015-26	J1	13-Pin, Dual row .1" Hdr. Conn HDR2X13
02	1	045-5015-02	J2	7-Pin, Dual Row .1" Hdr. Conn HDR2X7
03	1	045-5015-03	J3	3-Pin, PKK156B Connector
04	1		J4	6-Pin (6P100)
05	7		C35-C39, C40, C41	SMT 0.01uF, 50v Cap. 103-0805-X7R
06	20		C21, C24, C28-C32, C33, C34, C42, C43, C44, C45, C46 C47, C48, C49, C50, C53 (C51: NS)	SMT 0.1uF, 50v Cap. 104-0805
07	2		C26, C27	SMT 0.22uF, 50v Cap. 224-1206-Z5U
08	21		C1-C12, C13-C18, C20, C23, C52	SMT 470pF, 50v Cap. 471-0805
09	2		C19, C25	100uF, 25v TCap.
10	1	165-5099-00	L1	LED T1-3/4 DIFFUSER RED
11	4		R16-R18 (R19: NS)	0 Ω 1/10W Resistor 0805
12	1	n/a	RESET	DO NOT STUFF
13	2		R11, R13	SMT 1K Ω 1/10W Resistor 0805
14	1		R8	SMT 1M Ω 1/10W Resistor 0805
15	5		R1, R2, R3, R7 (R6: NS)	SMT 10K Ω 1/10W Resistor 0805
16	9		R21, R22-R29	SMT 33 Ω 1/10W Resistor 0805
17	1		R20	SMT 100 Ω 1/10W Resistor 0805
18	2		R9, R15	SMT 100K Ω 1/10W Resistor 0805
19	1		R5	SMT 180 Ω 1/10W Resistor 0805
20	3		R10, R12, R14	SMT 220 Ω 1/10W Resistor 0805
21	1		U1	74HCT04D (74LS04)
22	1		U2	74LS245DW
23	1	100-0189-01	U3 (40-Pin Socket, 077-X)	MC6809E
24	1	100-5044-00	U4	XC9572XL, Int. Xilinx®
25	2 (See Pg. DR. Table)		U5 (ROM0) (U6: NS) (32-Pin, IC Dip Socket, 077-5217-00)	4MB ROM 27C040 (M27C401-100)
26	1		U7	74HCT273D
27	1	100-5045-00	U8	K6T0808C1D-GB55, Int. Samsung 046A
28	1		U9	74HCT245D
29	1		U11	LM3940IMP-3.3
30	1		RSN1	8MHZRSN (8Mhz) Crystal
31	2	n/a	FB1, FB2	Ferrite Bead, FB0370
32	0		FID1-3	FIDTP50M

If a part is required where a part number is not provided, call Technical Support (see back of cover).

Sec. 5: PCBs



I/O Power Driver Board Theory of Operation

5v Supply:

An AC voltage of approximately 9v comes into the board at [J17-(1-4)] this AC voltage is then *full-wave rectified* by bridge **BRDG 21** and filtered by Capacitor **C203**. The resulting voltage is 11v DC which is inserted into a linear voltage regulator for the output of 5v DC. This 5v regulated voltage can be adjusted by potentiometer **R116** the voltage should be set to 5.00v. Besides powering the **I/O Board** the regulated 5 volts supplies power to the **CPU / Sound Board, Gas Plasma (Dot Matrix) Display** and **Plasma (Display) Controller Board**. Power for these devices comes off the **I/O Board** on [J16-(4-8)].

+5v, +20v, +50v, +18v, & +12v LED Indicators:

These DC voltages are derived on the **I/O Board** by rectification and filtering. Each has a **LED** indicating that power is being supplied to each of these voltage sources. The **-12v** supply comes from the same transformer winding as the **+12v** thus it does not have a **LED** indicator.

LED	SUPPLY VOLTAGE
L2	+ 5
L200	+ 20v
L201	+ 50v
L202	+ 18v
L203	+ 12v

**** Note that the +50v & +20v power sources are turned off by the Interlock Switches when the Coin Door is OPEN.**

Reset Circuitry:

The **I/O** will reset in three (3) cases:

1. The CPU is in reset. The CPU's reset signal is fed into the **I/O** through connector **J1** and forces the **I/O** into reset.
2. The 5v supply has fallen below 4.75v.
3. The watchdog is not being fed by the scanning of the light matrix. More specifically **Pin-19** of **U6** must be toggling once every **50ms** to prevent the watchdog from resetting. The scanning of the light matrix is controlled by the CPU through **J1**.

LED L204 shows the reset state of the **I/O Board**. If this **LED** is not lit either the 5v DC is below 4.75v or the **CPU/Sound Board** is holding the **I/O** in reset. If the **LED** is flashing this means that the watchdog is not being feed by the **CPU/Sound Board** and the **I/O** is oscillating into and out of reset. If the **LED** is continuously on the board is out of reset and communication from the CPU to the lamp matrix is confirmed. **Testpoint Blanking** is the actual reset signal on the **I/O Board**. A low voltage indicates that it is in reset this will turn off all Solenoid (*Coil*) Drivers, Flash Lamps, Lamp Matrix Drivers, Auxiliary Outputs and Flipper Outputs. A high voltage indicates that it is out of reset and normal operation can take place.

Address Decoding:

All Address decoding is done by two **74LS138's (U204 & U205)** (3 of 8 decoder). Both of these must be in operation for the **I/O Board** to function properly.

Solenoid (Coil) Drivers & Flash Lamps:

J8 & J9 are high side drivers for driving solenoids and other heavy loads. Each connector has its own buffer driving 8 drivers. **J8 & J9** consist of **MOSFET Drivers 20N10L** which can easily & safely be tested by clipping one end of a clip-lead to test point **FET TPL1** and then the other to the corresponding gate resistor **R1-R16** (see *Note 1*). This will apply 3.4v to the gate of the **MOSFET Transistor** thus switching it on. **J7 & J6** each are a bank of 8 low side driver for driving lamps or other lower current solenoids (*coils*). They use a Bipolar Power Transistor **TIP122** which can also be tested by using **TEST POINT TIP TPL3** and the corresponding resistors **R17-R32*** (see *Note 1*).

Note 1 • Clip on the resistor side with the white stripe. •• R1 controls Q1, R2 controls Q2, et cetera...

Auxiliary In & Out:

J2-8 CMOS Outputs sometimes used for a printer interface.

J3-8 CMOS Inputs general purpose inputs.

Lamp Matrix:

J12 has 10 low side drivers for the lamp strobes which consist of **19N06L MOSFETS**. Only one lamp strobe should be low at any time. Again the scanning of the lamp strobes keeps the **I/O** from resetting. **J13** has 8 high side drivers with each having a status indicator. All the status indicators are logically 'OR'ed together and fed back to the **CPU/Sound Board**. The status can identify open loads (for example open lamp filaments or intermittent connections) and short circuits. These drivers are also short-circuit protected.

General Illumination (G.I.) Lights:

J15 has 6v AC switched on & off by a relay on the **I/O Board**. The relay is controlled by **Q200** which supplies power to the 24v coil winding to activate the relay. There are 4 taps on **J15** each fused at 5A for this 6v AC source.



I/O Power Driver Board Schematic (Sheet 1 of 5)

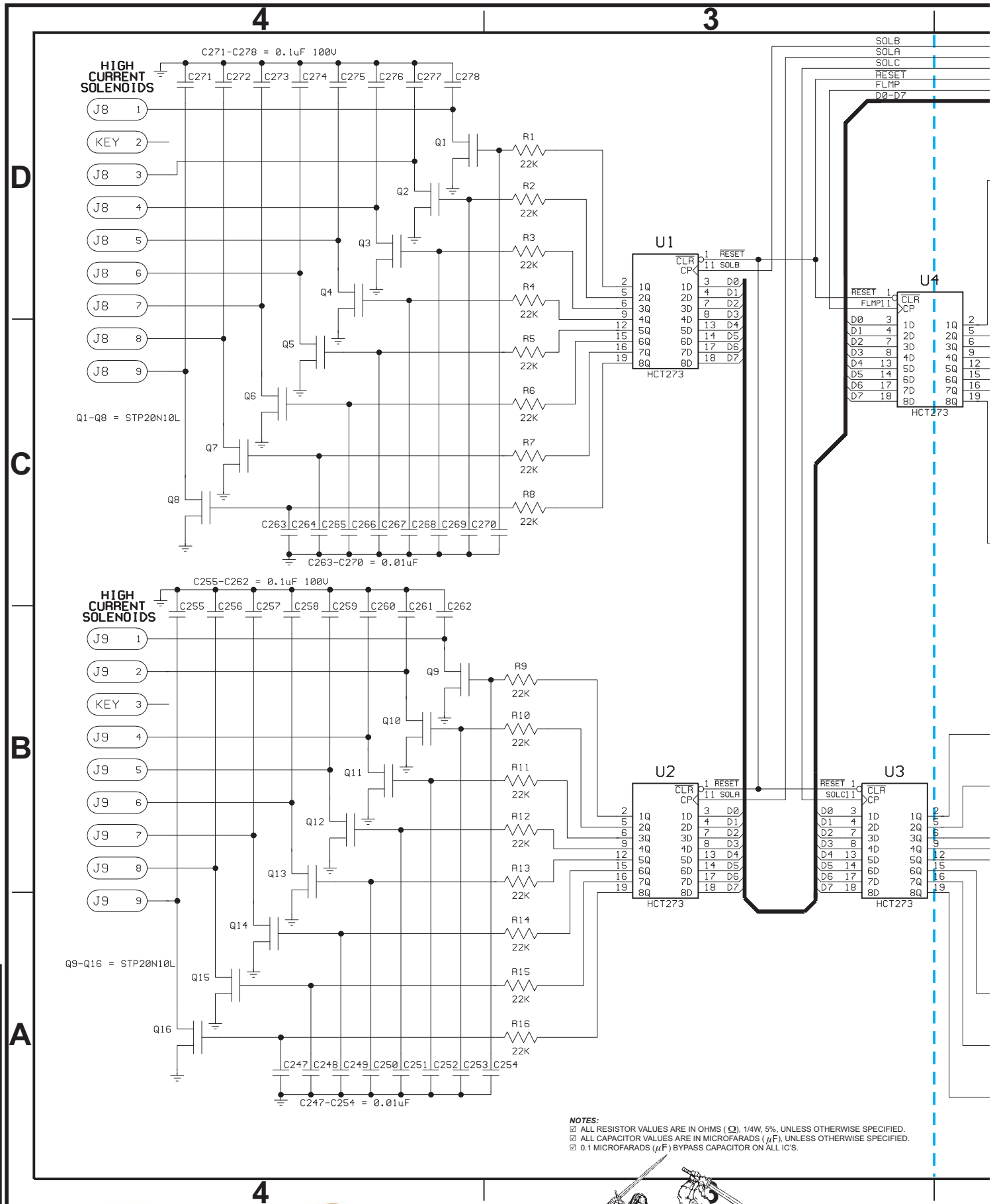

NOTES:
 [X] ALL RESISTOR VALUES ARE IN OHMS (Ω), 1/4W, 5%, UNLESS OTHERWISE SPECIFIED.
 [X] ALL CAPACITOR VALUES ARE IN MICROFARADS (μ F), UNLESS OTHERWISE SPECIFIED.
 [X] 0.1 MICROFARADS (μ F) BYPASS CAPACITOR ON ALL IC'S.

Sec. 5: PCBs

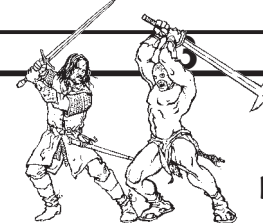

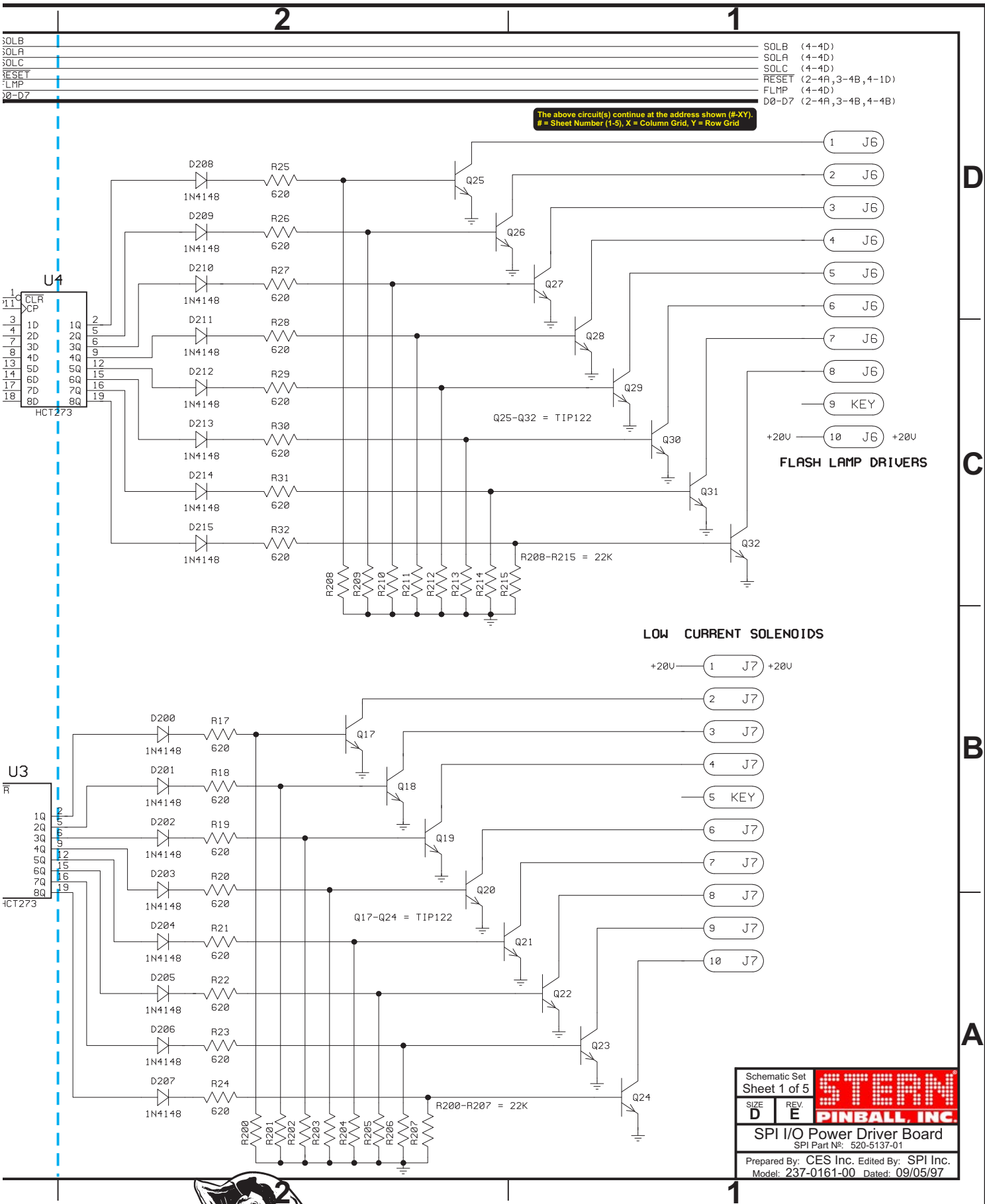

Schematic Set		STERN
Sheet 1 of 5		
SIZE	REV.	PINBALL, INC.
D	E	
SPI I/O Power Driver Board		
SPI Part No: 520-5137-01		
Prepared By: CES Inc. Edited By: SPI Inc.		
Model: 237-0161-00 Dated: 09/05/97		

D
C
B
A

Sec. 5: PCBs

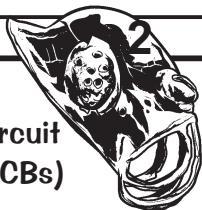

I/O Power Driver Board Schematic (Sheet 2 of 5)

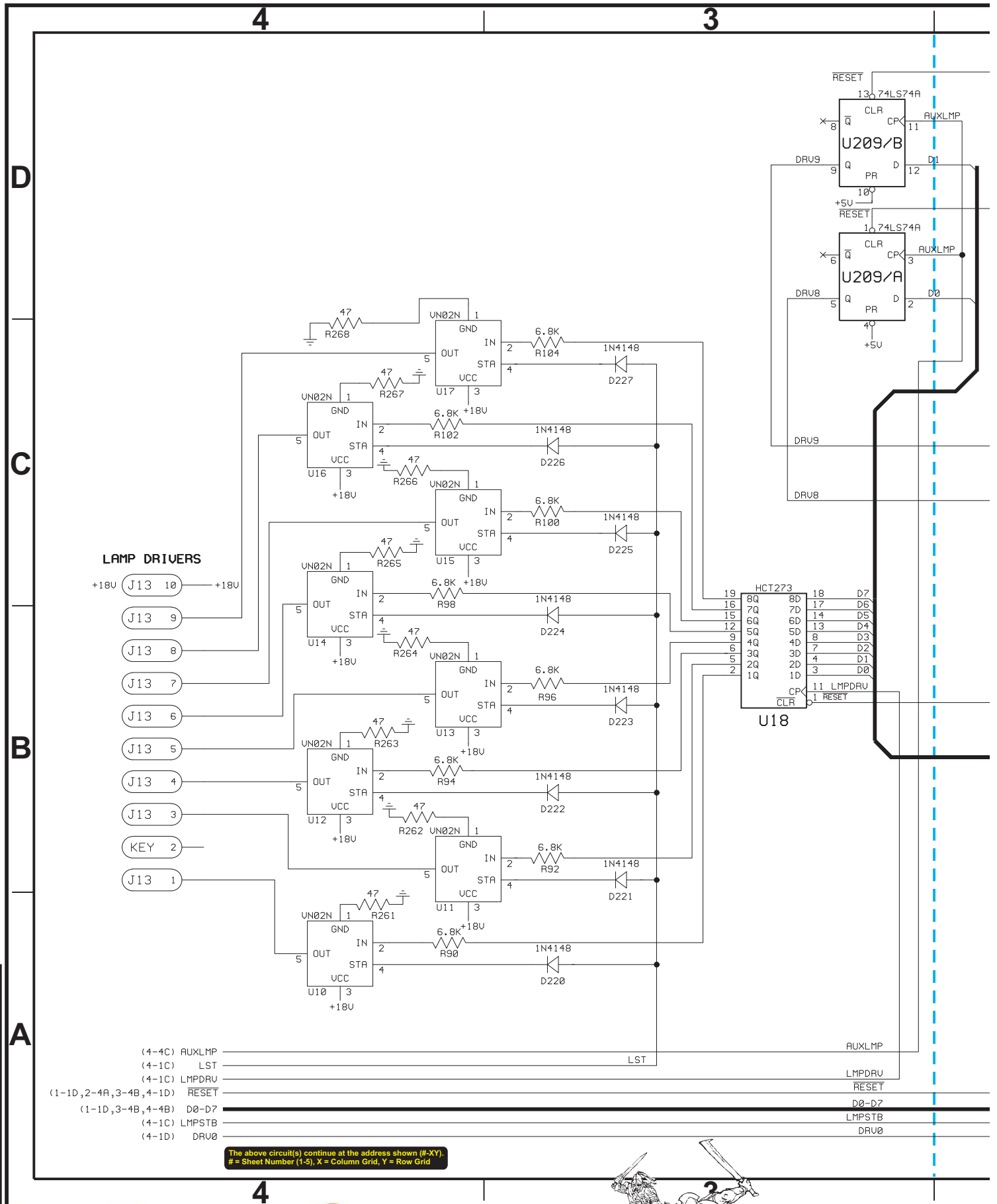

- (4-4C) AUXLMP
- (4-1C) LST
- (4-1C) LMPDRU
- (1-1D, 2-4A, 3-4B, 4-1D) RESET
- (1-1D, 3-4B, 4-4B) D0-D7
- (4-1C) LMPSTB
- (4-1D) DRV0

The above circuit(s) continue at the address shown (#.XY)
 # = Sheet Number (1-5), X = Column Grid, Y = Row Grid

Sec. 5: PCBs

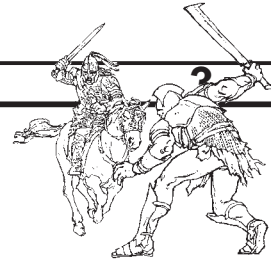

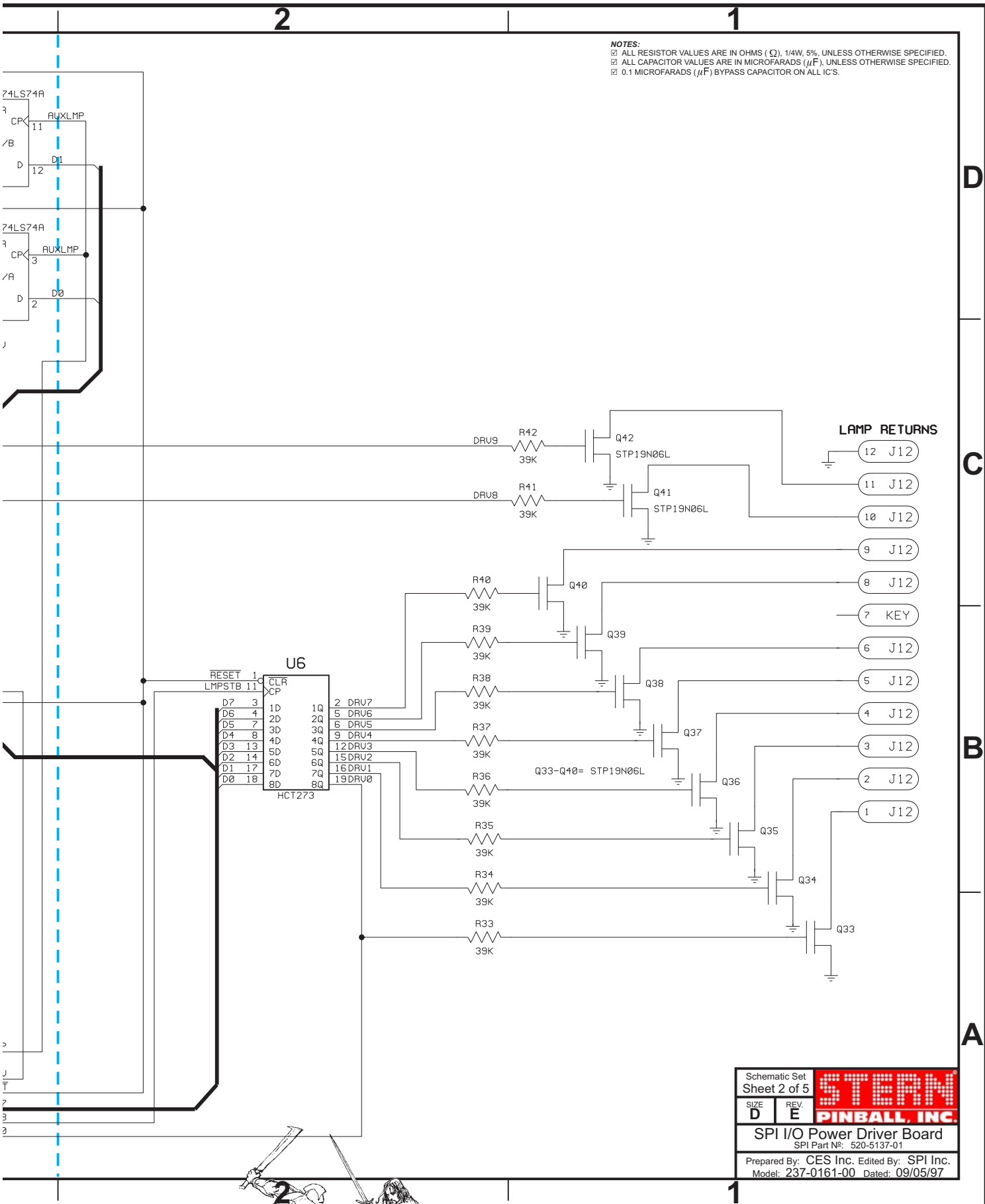

Schematic Set Sheet 2 of 5		STERN PINBALL, INC.
SIZE D	REV. E	
SPI I/O Power Driver Board SPI Part No: 520-5137-01		
Prepared By: CES Inc. Edited By: SPI Inc. Model: 237-0161-00 Dated: 09/05/97		

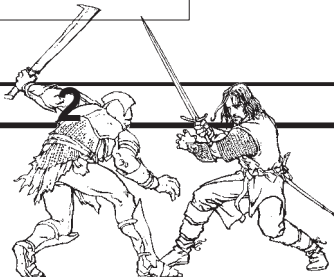

I/O Power Driver Board Schematic (Sheet 3 of 5)

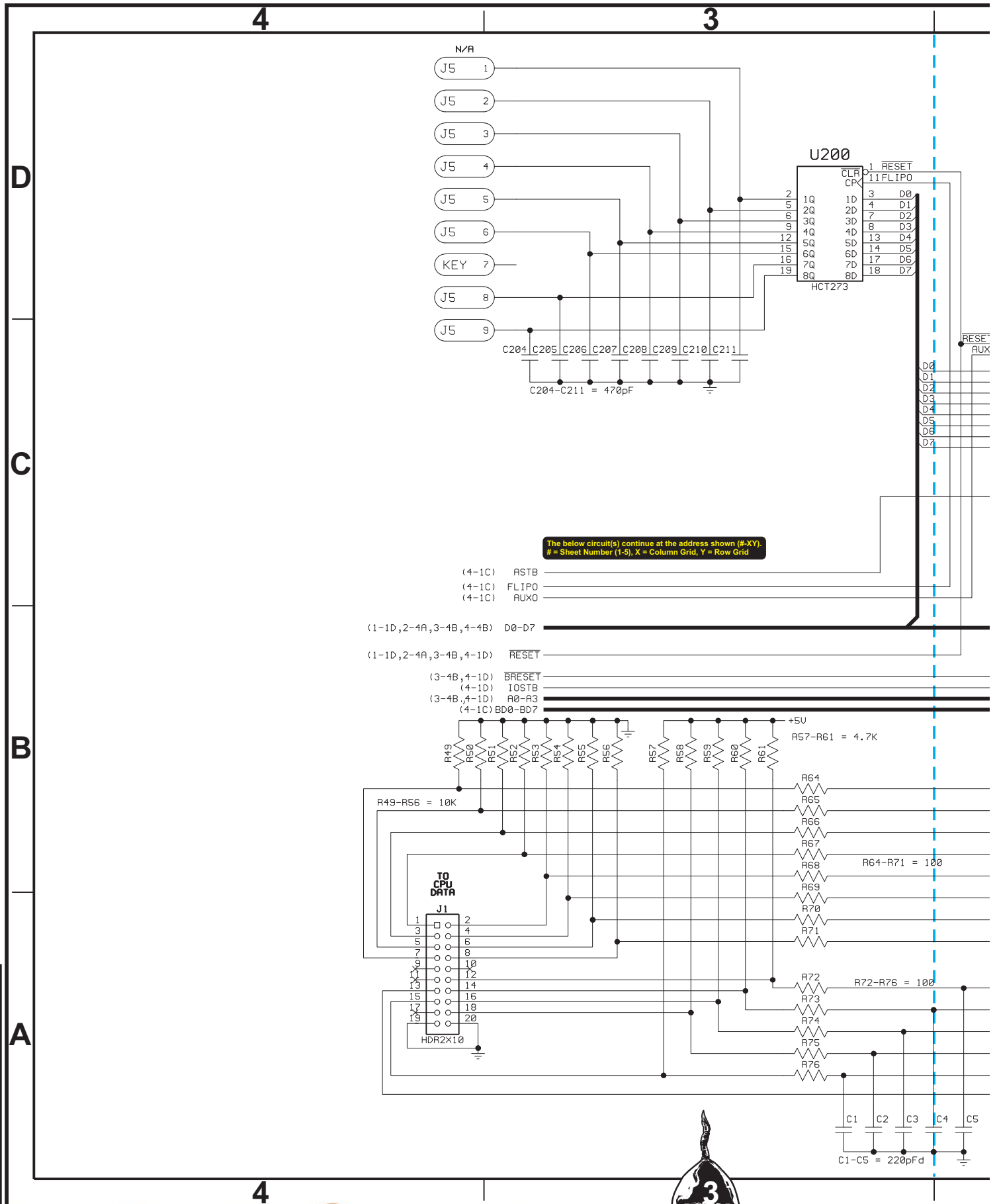

Sec. 5: PCBs



2

1

NOTES:
 ☑ ALL RESISTOR VALUES ARE IN OHMS (Ω), 1/4W, 5%, UNLESS OTHERWISE SPECIFIED.
 ☑ ALL CAPACITOR VALUES ARE IN MICROFARADS (μF), UNLESS OTHERWISE SPECIFIED.
 ☑ 0.1 MICROFARADS (μF) BYPASS CAPACITOR ON ALL IC'S.

DATE	DESCRIPTION OF CHANGES / REVISIONS	REQ.	BY.
JAN 2001	Cut trace on solder side at Aux. Out Port J2-PIN1 thru J2-PIN3 & J2-PIN5 thru J2-PIN9; Soldered Resistor 100Ω 1/4W 5% (SPI N#: 121-5007-00). This Modification (highlighted below at J2 with a dotted-line box) was accomplished on boards produced after Jan. 1, 2001. This board is backwards compatible for the White Star™ Board System.	TS	JET

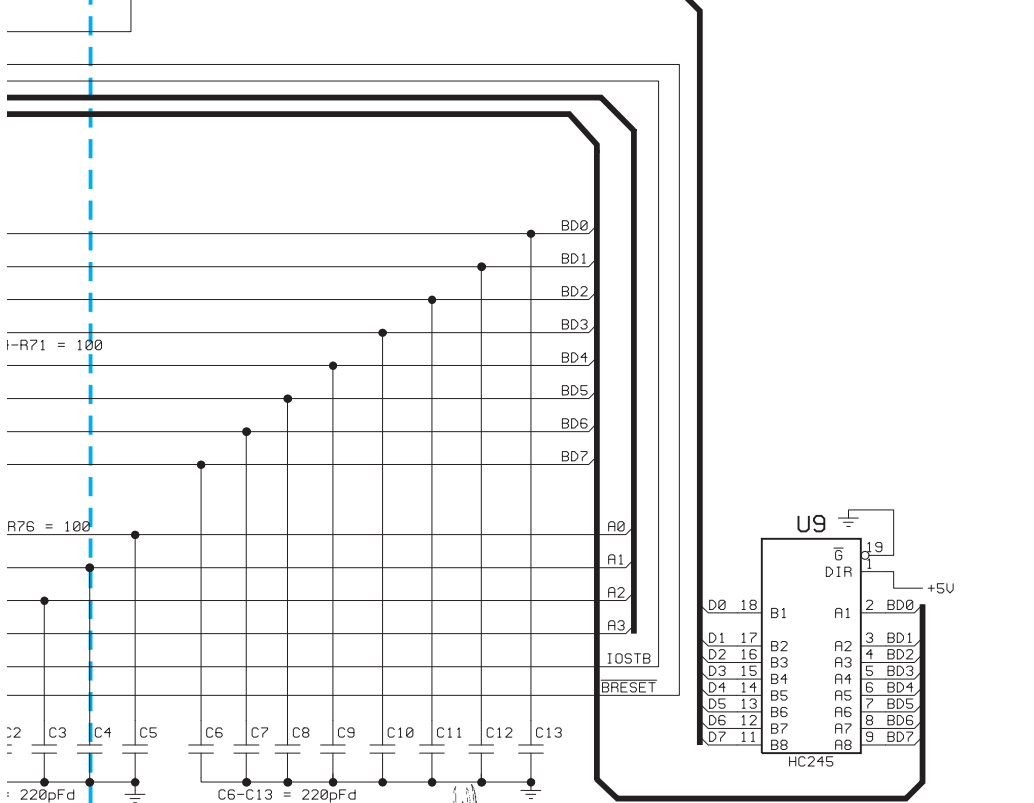
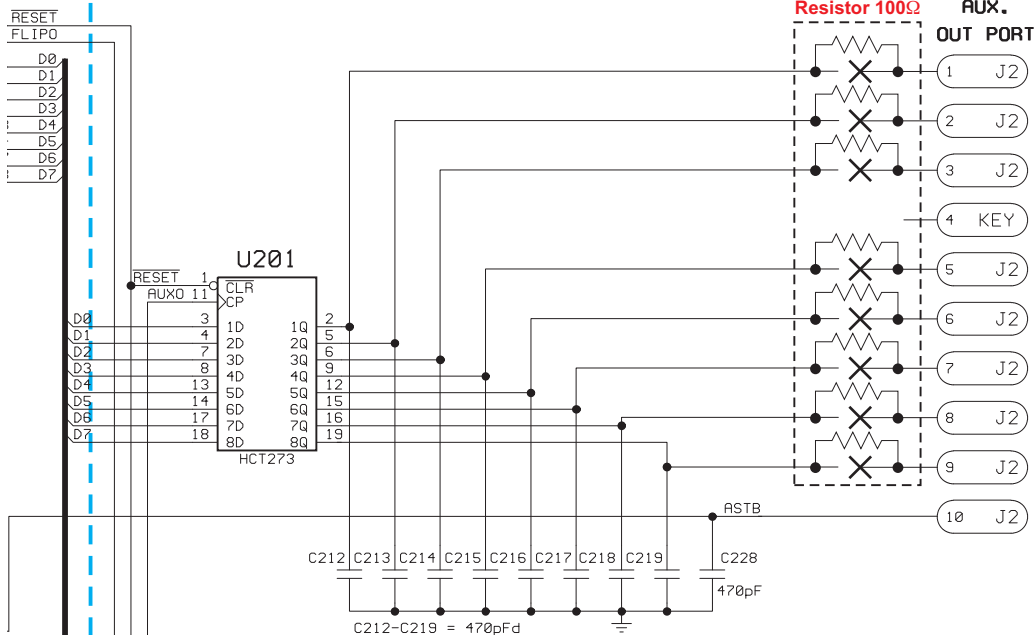

Schematic Set		STERN
Sheet 3 of 5		
SIZE	REV.	PINBALL, INC.
D	E	
SPI I/O Power Driver Board		
SPI Part N#: 520-5137-01		
Prepared By: CES Inc. Edited By: SPI Inc.		
Model: 237-0161-00 Dated: 09/05/97		

D

C

B

A

Sec. 5: PCBs

2

1



I/O Power Driver Board Schematic (Sheet 4 of 5)

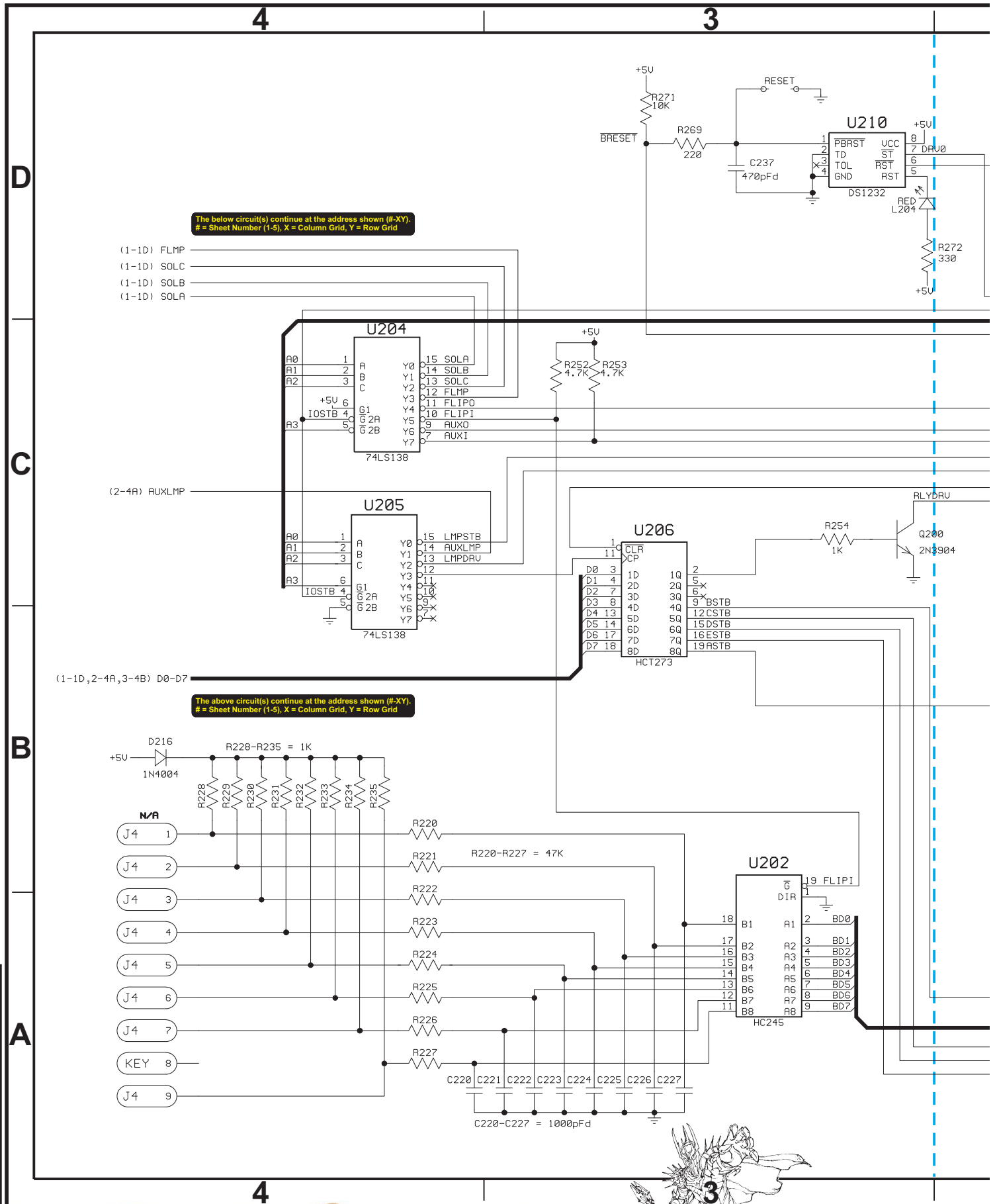

Sec. 5: PCBs

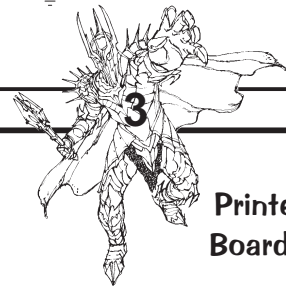

I/O Power Driver Board Schematic (Sheet 4 of 5)

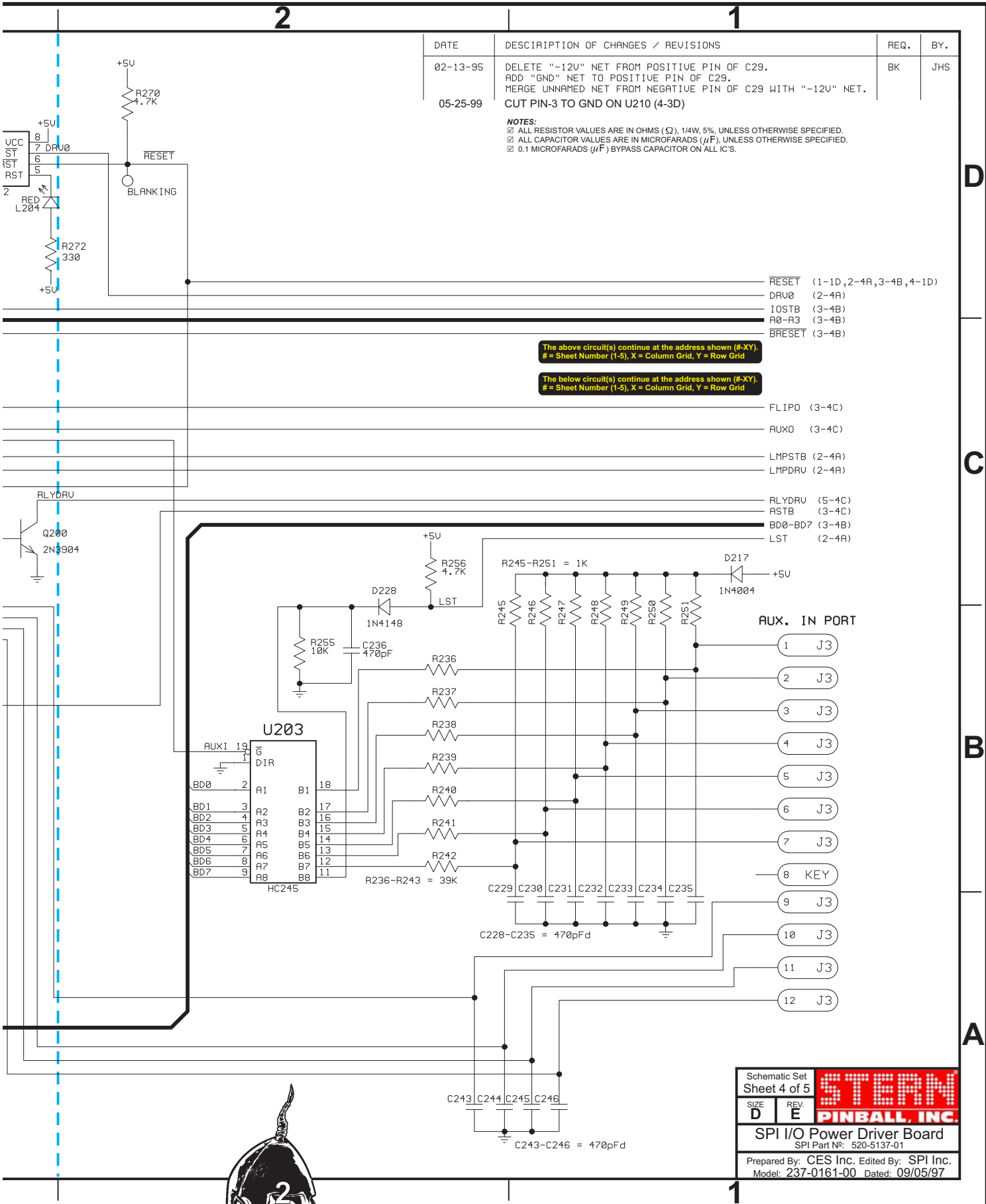

Schematic Set Sheet 4 of 5		STERN PINBALL, INC.
SIZE D	REV. E	
SPI I/O Power Driver Board SPI Part No: 520-5137-01		
Prepared By: CES Inc. Edited By: SPI Inc. Model: 237-0161-00 Dated: 09/05/97		

I/O Power Driver Board Schematic (Sheet 5 of 5)

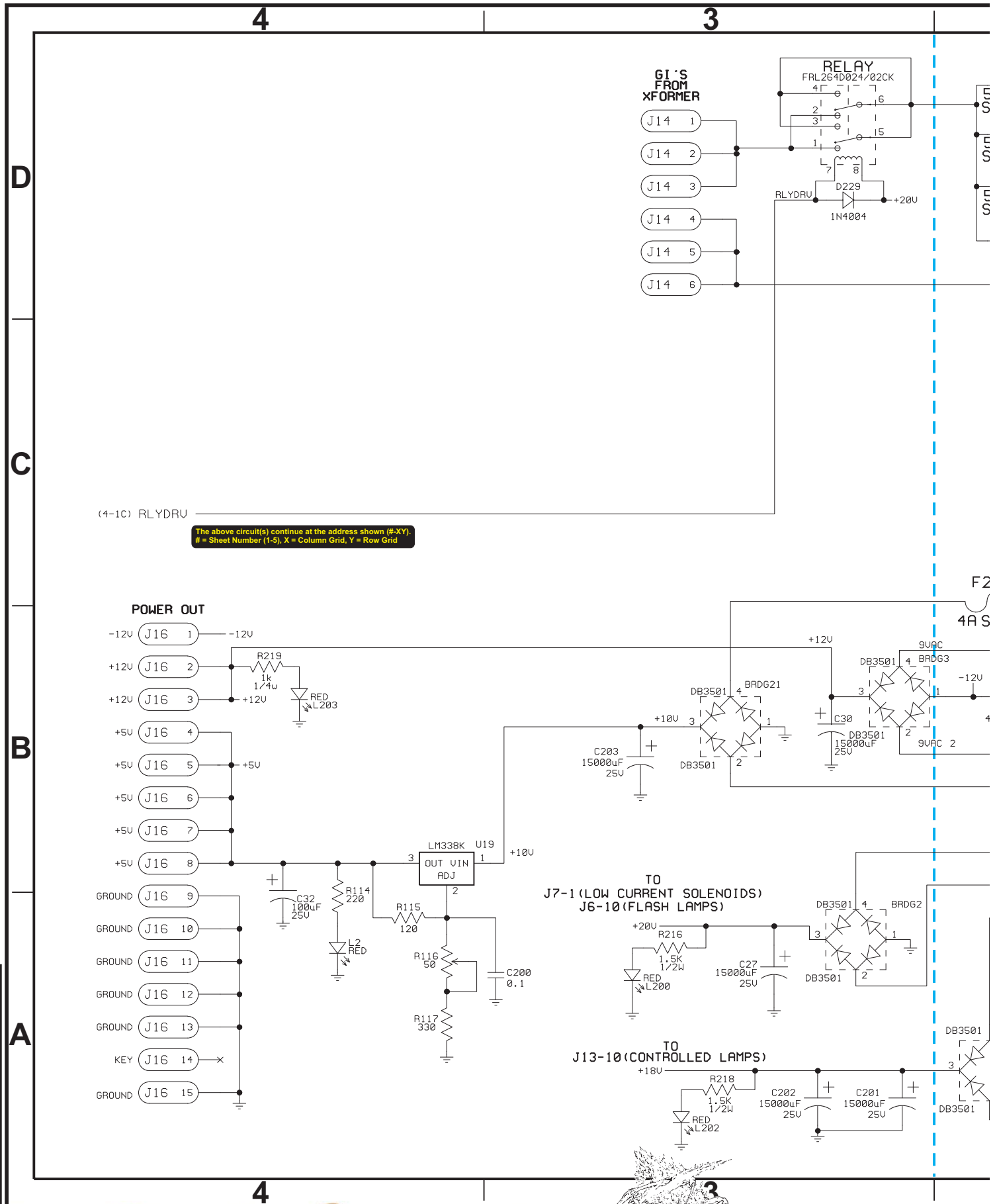

Sec. 5: PCBs



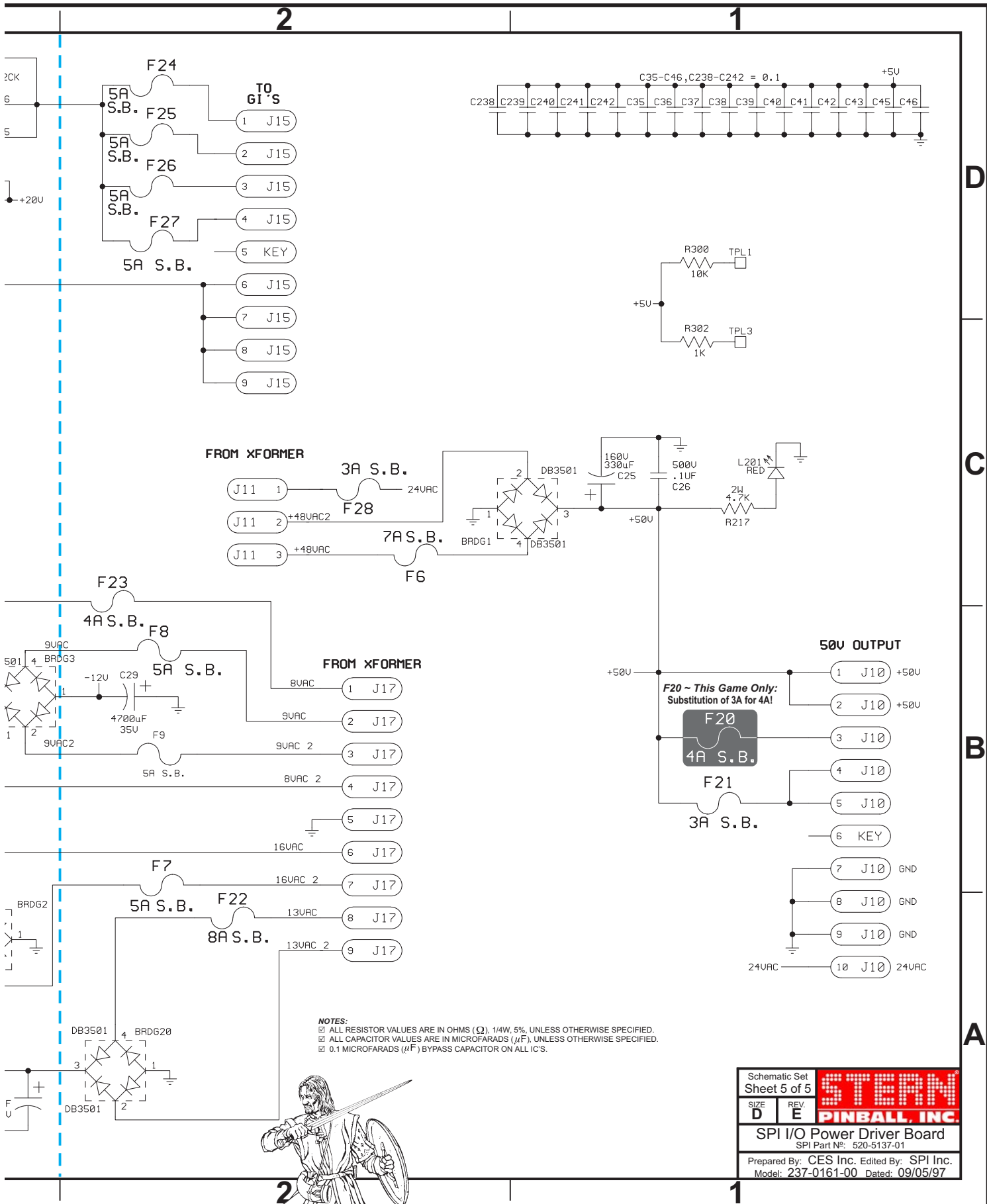

FROM XFORMER

FROM XFORMER

NOTES:
 ☑ ALL RESISTOR VALUES ARE IN OHMS (Ω), 1/4W, 5%, UNLESS OTHERWISE SPECIFIED.
 ☑ ALL CAPACITOR VALUES ARE IN MICROFARADS (μF), UNLESS OTHERWISE SPECIFIED.
 ☑ 0.1 MICROFARADS (μF) BYPASS CAPACITOR ON ALL IC'S.



Printed Circuit Boards (PCBs)

Schematic Set Sheet 5 of 5		STERN PINBALL, INC.
SIZE D	REV. E	
SPI I/O Power Driver Board SPI Part No: 520-5137-01		
Prepared By: CES Inc. Edited By: SPI Inc. Model: 237-0161-00 Dated: 09/05/97		

Sec. 5: PCBs

I/O Power Driver Board Component Layout

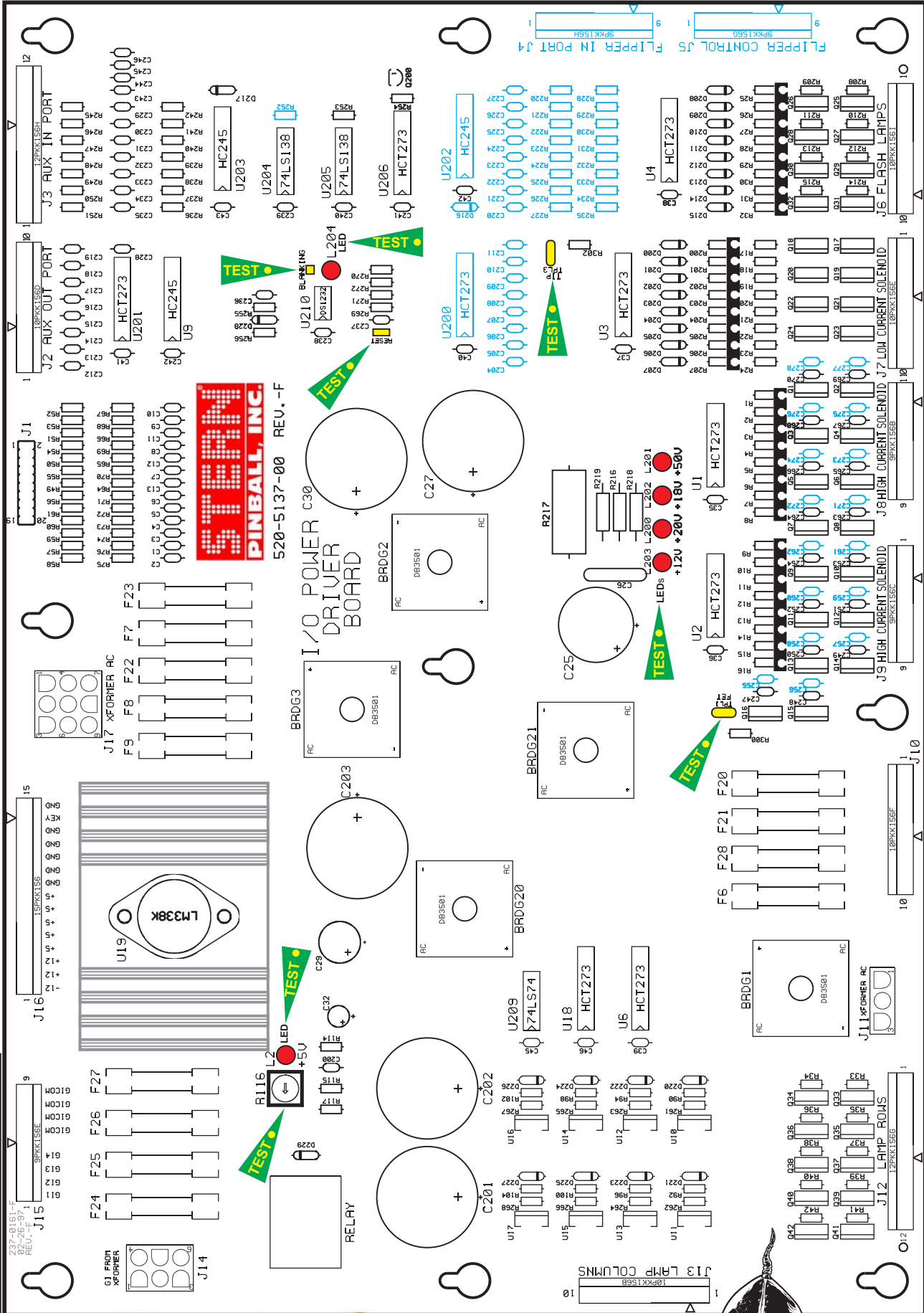

Test Points:



← TIP TPL3
← BLANKING
← L204 LED

← RESET

LEDs :
← L201+50v
← L202+18v
← L200+20v
← L203+12v

← FET TPL1

LED :
← L2+5V
← R116 POT

Actual Board Size 15.698" X 11"



I/O Power Driver Board Parts

ITEM	QTY	PART NUMBER	REF-DESIGNATOR	DESCRIPTION (NS = Not Stuffed)
—	1	520-5137-01	I/O Power Driver Board	Complete PCB Assembly
01	5	112-5000-00	BRDG1, BRDG2, BRDG3, BRDG20, BRDG21	DB3501
02	13	125-5030-00	C1, C2, C3>C6, C7, C8, C9>C10, C11, C12	220pF, (221), Cap.
03	1	125-5033-00	C25	100uF, 150v, Radial Lytic Cap.
04	1	125-5035-00	C26	.1uF, 500v, Ceramic Disk Cap.
05	5	125-5036-00	C27, C30, C201, C202, C203	15000uF, 25v, Radial Lytic Cap.
06	1	125-5034-00	C29	4700uF, 35v, Radial Lytic Cap.
07	1	125-5032-00	C32	100uF, 25v, Radial Lytic Cap.
08	17	125-5031-00	C35, C36, C37, C38, C39, C40, C41, C42, C43, C45, C46, C200, C238, C239, C240, C241, C242	0.1uF, (104), Cap.
09	22	125-5028-00	C212>C219, C228>C237, C243>C246 (C204-C211: NS)	470pF, (471), Axial Cap.
10	0	n/a	(C220>C227: NS)	
11	16	125-5029-00	C247>C254, C263>C270	0.01uF, (103), 100v Cap.
12	0	125-5027-00	(C255>C262, C271>C278: NS)	0.1uF, (104), 100v, Cap.
13	25	112-0054-00	D200>D207, D208>D215, D220, D221, D222, D223, D224, D225, D226, D227	1N4148, Diode
14	2	112-5003-00	D217, D229 (D216: NS)	1N4004, Diode
15	26	205-0004-00	F6, F7, F8, F9, F20, F21, F22, F23, F24> F27, F28	Fuse Clips
16	1	200-5000-03	F6	7A 250v S.B. Fuse
17	7	200-5000-01	F7, F8, F9, F24>F27	5A 250v S.B. Fuse
18	2	200-5000-08	F21, F28	3A 250v S.B. Fuse
19	1	200-5000-05	F22	8A 250v S.B. Fuse
20	2	200-5000-06	F20, F23	4A 250v S.B. Fuse
21	1	045-5015-01	J1	20-Pin, 0.1 Dual Row Header
22	1	045-5014-01	J2 (Key Pin-4), J6 (Key Pin-9), J7 (Key Pin-5) J10 (Key Pin-6), J13 (Key Pin-2)	10PKK156
23	1	045-5015-00	J3 (Key Pin-8)	12PKK156
	0	n/a	(J4, J5: NS)	
24	1	045-5013-00	J8 (Key Pin-2), J9 (Key Pin-3), J15 (Key Pin-5)	9PKK156
25	1	045-0014-03	J11	10-84-4030 (3-Pin MOLEX)
26	1	045-5015-00	J12 (Key Pin-7)	12PKK156
27	1	045-0014-06	J14	10-84-4060 (6-Pin MOLEX)
28	1	045-5016-00	J16 (Key Pin-14)	15PKK156
29	1	045-0014-09	J17	10-84-4090 (9-Pin MOLEX)
30	6	165-5099-00	L2, L200, L201, L202, L203, L204	LED T1-3/4 DIFFUSER LED
31	16	110-0106-00	Q1>Q16	22NE10L STP, Transistor
32	16	110-0067-00	Q17>Q24, Q25>Q32	TIP122
33	10	110-0088-00	Q33>Q42	19N06L STP, Transistor
34	1	110-0069-00	Q200	2N3904, Transistor.
35	32	121-5042-00	R1>R8, R9>R16, R200>R207, R208>R215	22K Ω 1/4W Res.
36	16	121-5003-00	R17>R24, R25>R32	620 Ω 1/4W Res.
37	17	121-5045-00	R33>R42, R236>R242	39K Ω 1/4W Res.
38	8	121-5021-00	R49, R57>R61, R253, R256, R270 (R252: NS)	4.7K Ω 1/4W Res.
39	11	121-5011-00	R50>R56, R255, R271, R300	10K Ω 1/4W Res.
40	13	121-5007-00	R64>R76	100 Ω 1/4W Res.
Resistors on Solder Side @ J2-Pins: 1-3 & 5-9				
41	8	121-5029-00	R90, R92, R94, R96, R98, R100, R102, R104	6.8K Ω 1/4W Res.
42	2	121-5033-00	R114, R269	220 Ω 1/4W Res.
43	1	121-5030-00	R115	120 Ω 1/4W Res.
44	1	121-5039-00	R116	50 Ω Pot
45	2	121-5036-00	R117, R272	330 Ω 1/4W Res.
46	2	121-5038-00	R216, R218	1.5K Ω 1/2W Res.
47	1	121-5050-00	R217	4.7K Ω 2W Res. (SANDBAR)
48	1	121-5009-00	R219, R245>R251, R254, R302 (R228>R235: NS)	1K Ω 1/4W Res.
49	8	121-5016-00	R261, R262, R263, R264, R265, R266, R267, R268	47 Ω 1/4W Res.
50	1	190-5002-00	RELAY	FRL264D024/02CK Relay
51	2	n/a	TPL1, TPL3	Test Point Wire (24ga.) Loops
52	8	100-5012-00	U1, U2, U3, U4, U6, U18, U201, U206 (U200: NS)	74HCT273
53	1	110-0058-00	U9	74LS245
54	1	100-5023-00	U210	DS1232
55	8	110-0089-00	U10, U11, U12, U13, U14, U15, U16, U17	VN02N
56	1	100-0356-00	U19	LM338K
57	1	n/a	U19	Heatsink (5v Reg.)
58	1	100-0338-00	U203 (U202: NS)	74HC245
59	2	100-0148-00	U204, U205	74LS138
60	1	100-0037-00	U209	74LS74
61	1	n/a	BLANKING, RESET	Test Points

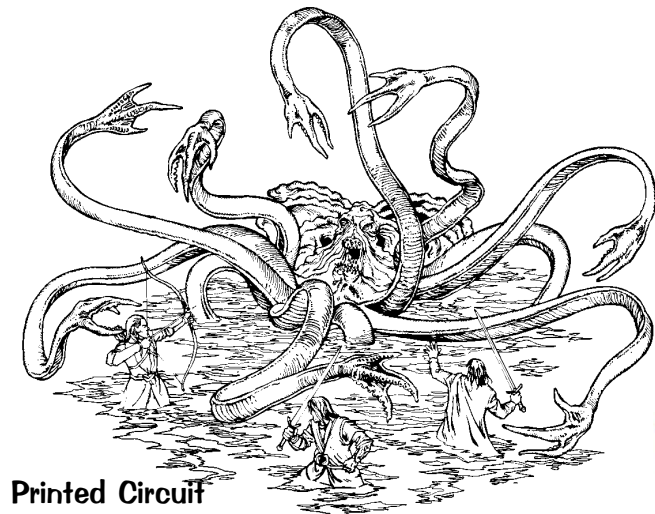

Printed Circuit Boards (PCBs)

To view Playfields (above & below), click this box.



Sec. 5: PCBs



Section 5, Chapter 4
Page 130

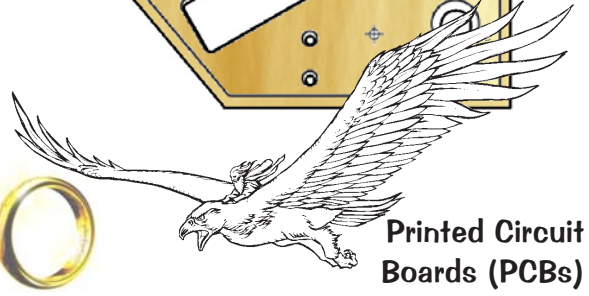

Printed Circuit Boards (PCBs)

CPU/Sound Board II (with ATMEL Processor) Theory of Operation

CPU Section:

The **CPU** is a **68B09E (U209)** with up to 8 MBytes of **CPU Code Space (U210)**. The **CPU** code is bank selected by the use of **U211** and each bank consists of 16 KBytes. 8 KBytes of **RAM (U212)** is available to the **CPU**. The RAM is battery backed and has a write protected area. Battery back up is accomplished by **3-AA Cells (BAT1)** Battery Pack which has a **TEST POINT (TP): VBATT** to check the battery voltage status. The write protected area consists of 512 Bytes used for storing game settings. This section of **RAM** can only be written to when the coin door is open. The Coin Door switch comes into the **CPU** on **CN6-12** and is fed into the address decoding **PAL U213**. When this memory protect signal is low writes to the protected **RAM** area are prohibited. Address decoding for the system is accomplished by one **PAL U213** and one 1-of-8 decoder **U214**.

A watchdog is used to monitor the **CPU** and the 5v supply. If the 5v supply is below 4.75 the watchdog will hold the **CPU/Sound Board & I/O Board** in *reset*. The watchdog must be fed at a rate of **250ms** or faster. The signal used to feed the watchdog comes from the EPROM Bank select signal used to load **U211**.

The **I/O** Interface **CN1** is buffered by two (2) **HC245** Chips (**U207 & U208**). The **CPU's** reset line is buffered by **Q10** and fed over to the **I/O** through **CN1**. An *I/O Strobe Signal* is fed through **CN1-15** and is used to notify the **I/O** that a valid address is being sent.

Switches:

The Switch Matrix consists of eight (8) **2N3904** Transistors (**Q1-Q8**) which pull one of 8 strobes 'low' to *activate* a Single Column of switches. The *Switch Return Signals* are fed into **CN7** [SWITCH ROWS] and are highly filtered and compared to a 2.5v *reference voltage*. The *Switch Return Voltage* must be below 2.5v to make a *Valid Switch Closure*. If *false switches* are appearing, check that none of the **2N3904** Transistors are permanently pulling the *strobe line low*. Only one strobe from **CN5** [SWITCH COLUMNS] should be *low at any time*. **CN6** [DEDICATED SWITCH IN] is a *Dedicated Bank of Input Switches*. Switches connected to **CN6** are connected to ground instead of a strobe and may be read at any time.

Plasma Interface:

The data path for communication to and from the **Plasma Controller Board** is 8 bits wide. There are separate *Input* and *Output Busses*. Data going out to the controller comes from the **CPU's Data Bus** through **U201** and onto **CN8-Pins 11-18**. Status back from the Plasma Controller comes in on **CN8-Pins 22-26** and is fed into **U202** for input to the **CPU's Data Bus**. Two control signals that go out to the Plasma Controller are **PRES** [TP17: PLASMA RESET] and **CN8-Pin 19 [PSTB - Plasma Strobe]**. The Plasma Reset is software controllable through **U216/B** and also has a test point "Plasma Reset". The *Plasma Strobe Signal* to the controller is generated from **U216/A** and is *used to latch data* into the Plasma Controller.

Other Test Points (TP):

TP 7: E & TP5: Q - The **CPU** signals for both **68B09E** processors. Should be at 2Mhz with **Q** leading **E** by **500 nsec**. **TP2: P0. TP3: P1. TP4: P2. TP20: (near U402). TP8: (near U219). TP1: +3.3V.**

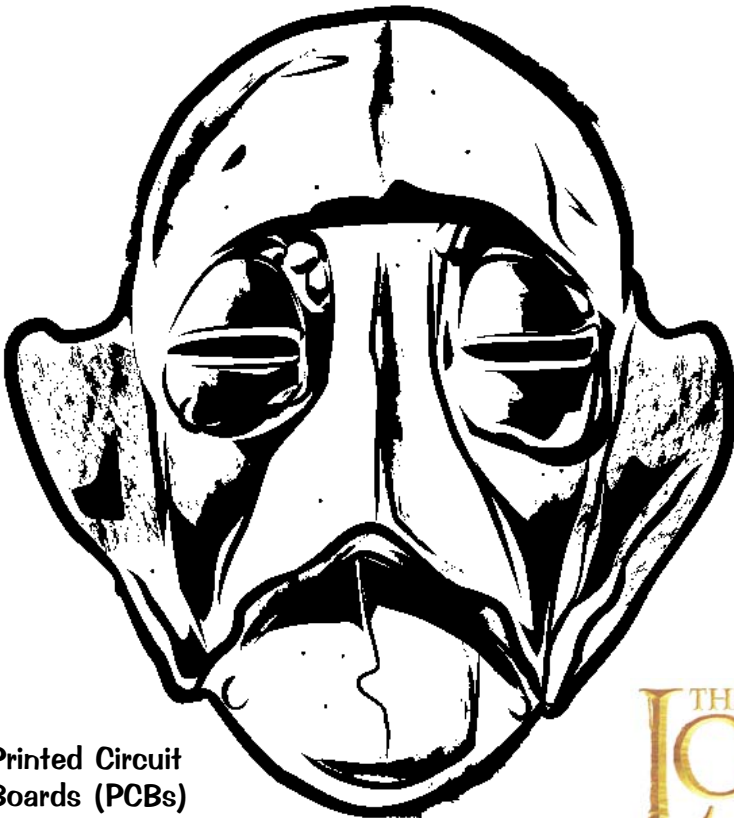

CPU/Sound Board II (with ATMEL Processor) Schematic (Sheet 1 of 4)

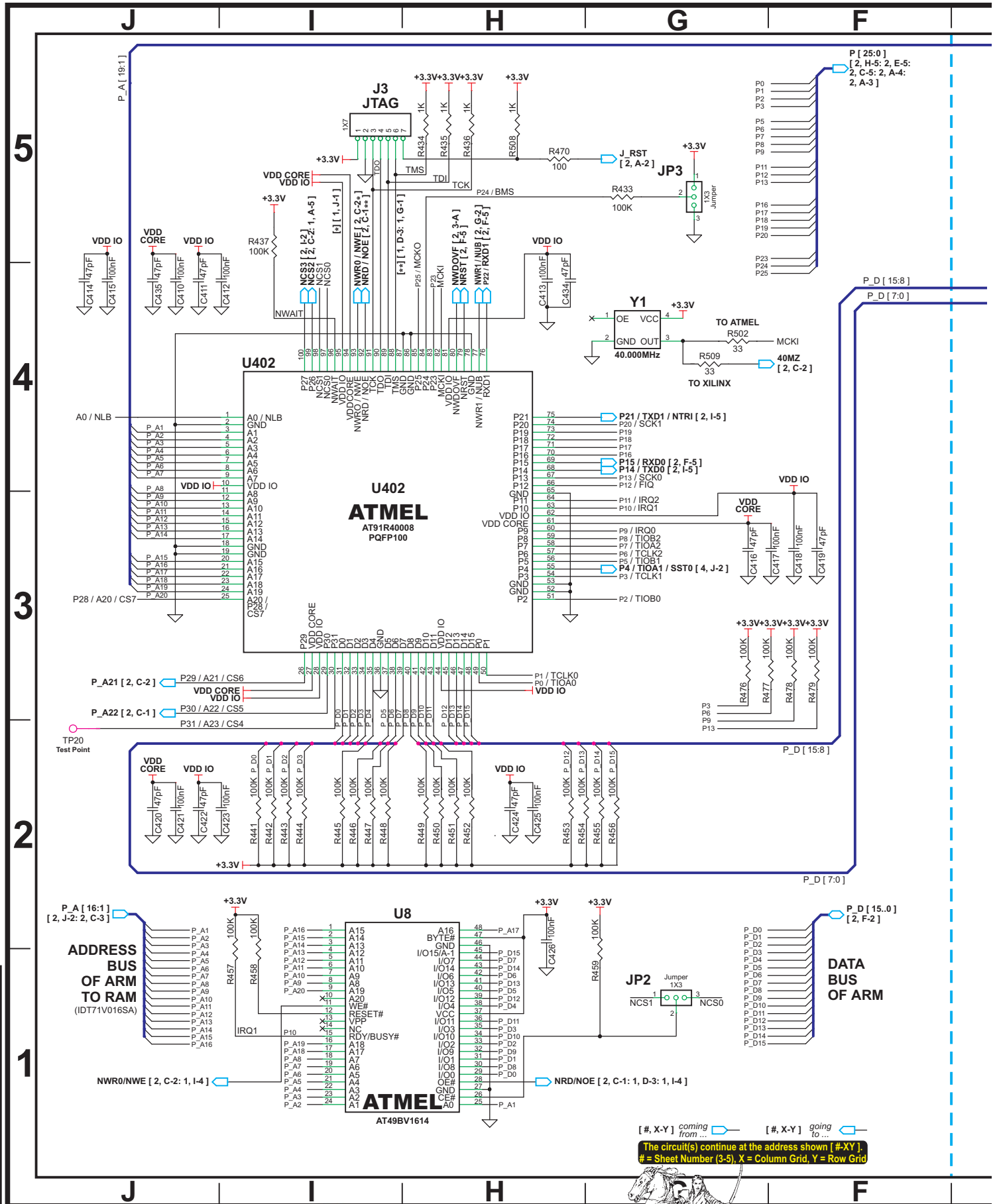

Sec. 5: PCBs



CPU/Sound Board II (with ATMEL Processor) Schematic (Sheet 1 of 4)

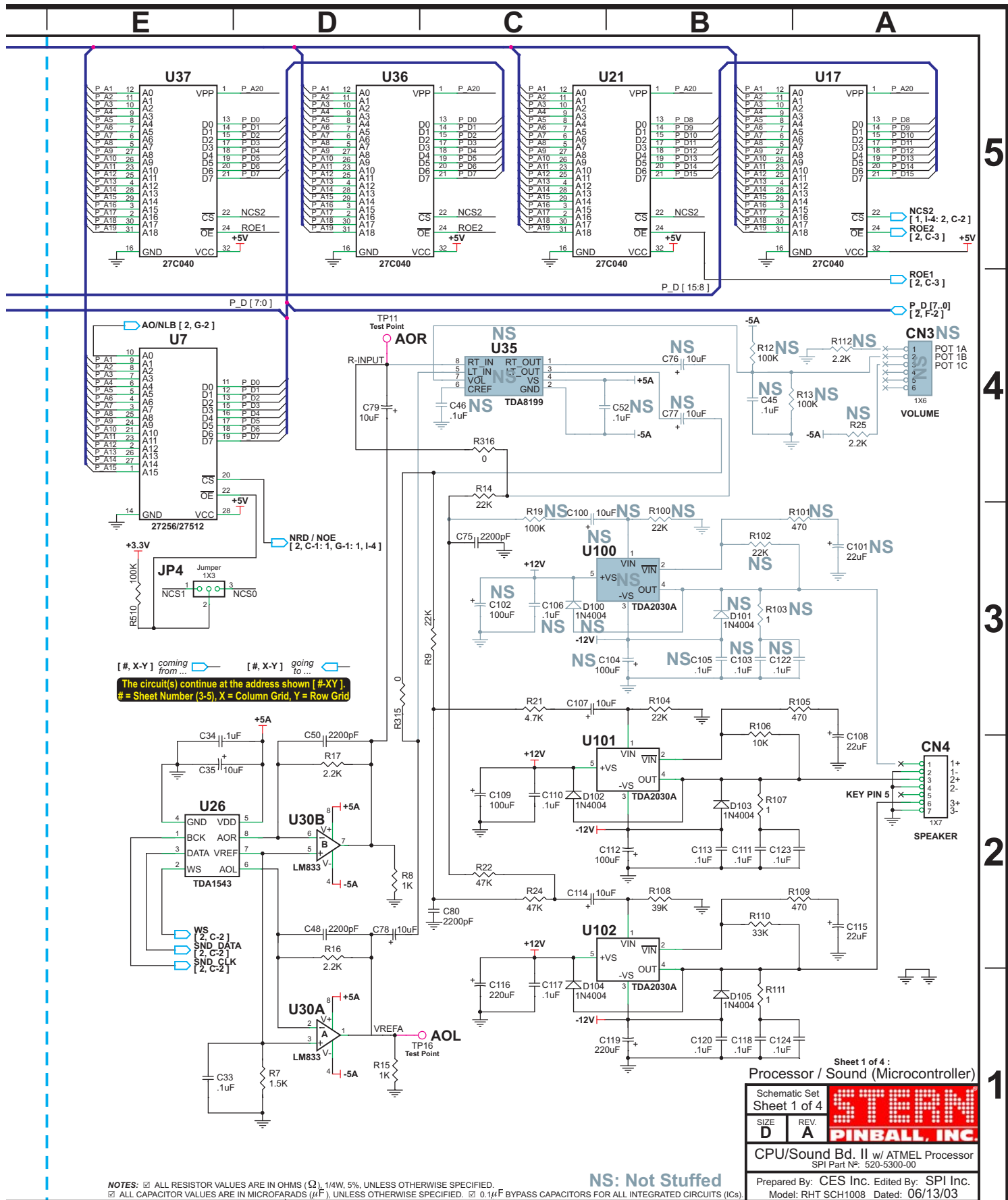

NOTES: □ ALL RESISTOR VALUES ARE IN OHMS (Ω), 1/4W, 5%, UNLESS OTHERWISE SPECIFIED.
 □ ALL CAPACITOR VALUES ARE IN MICROFARADS (μF), UNLESS OTHERWISE SPECIFIED. □ 0.1μF BYPASS CAPACITORS FOR ALL INTEGRATED CIRCUITS (ICs).

NS: Not Stuffed

Sheet 1 of 4:

Schematic Set		Sheet 1 of 4		STERN
SIZE	D	REV	A	
CPU/Sound Bd. II w/ ATMEL Processor				
SPI Part No: 520-5300-00				
Prepared By: CES Inc. Edited By: SPI Inc.				
Model: RHT SCH1008 Dated: 06/13/03				



CPU/Sound Board II (with ATMEL Processor) Schematic (Sheet 2 of 4)

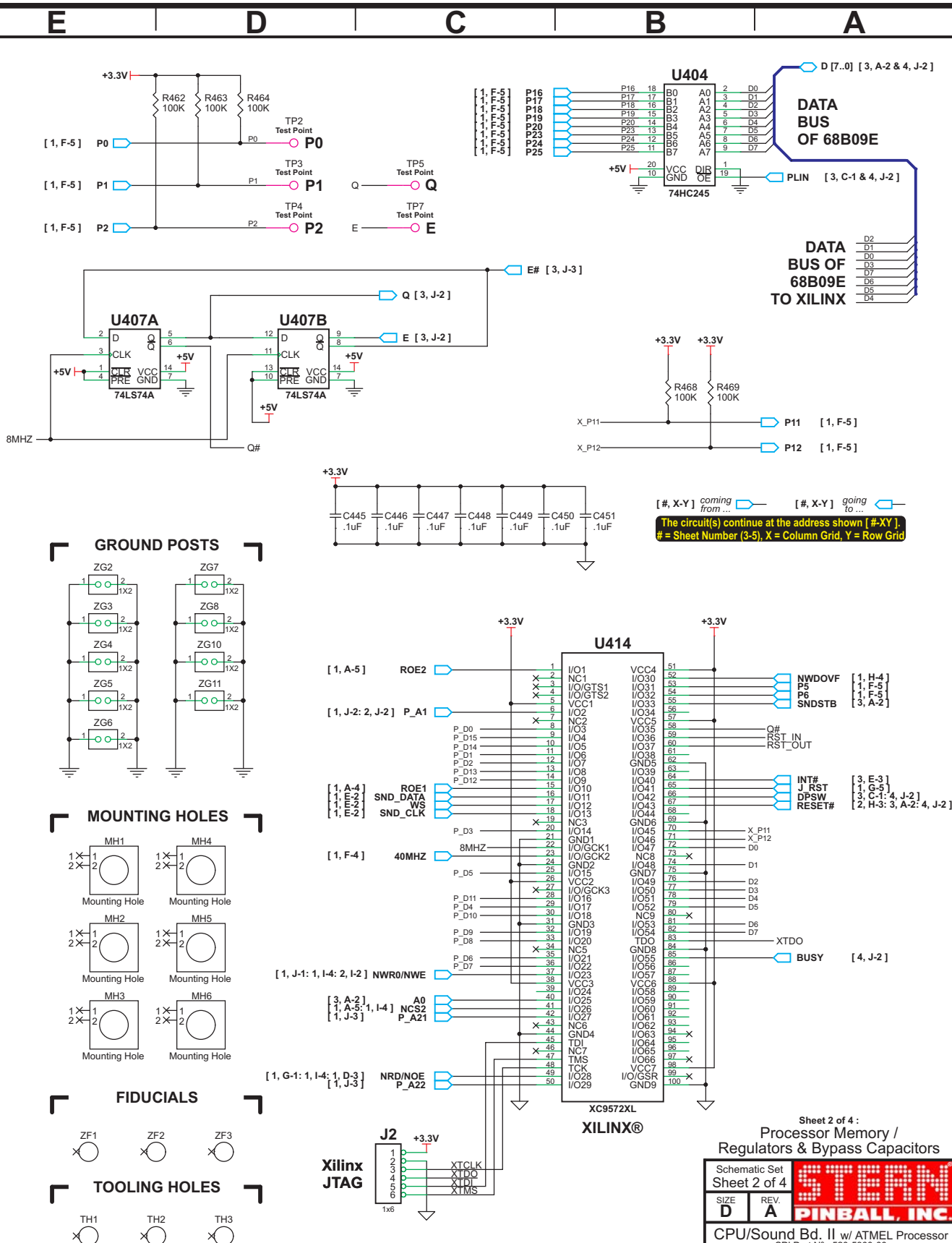

NOTES: □ ALL RESISTOR VALUES ARE IN OHMS (Ω), 1/4W, 5%, UNLESS OTHERWISE SPECIFIED.
 □ ALL CAPACITOR VALUES ARE IN MICROFARADS (μF), UNLESS OTHERWISE SPECIFIED. □ 0.1μF BYPASS CAPACITORS FOR ALL INTEGRATED CIRCUITS (ICs).

NS: Not Stuffed

Sheet 2 of 4 : Processor Memory / Regulators & Bypass Capacitors

Schematic Set	Sheet 2 of 4	STERN
SIZE	REV	
D	A	PINBALL, INC.

CPU/Sound Bd. II w/ ATMEL Processor
 SPI Part N°: 520-5300-00

Prepared By: CES Inc. Edited By: SPI Inc.
 Model: RHT SCH1008 Dated: 06/13/03



Sec. 5: PCBs

[#, X-Y] coming from ... [#, X-Y] going to ...
 The circuit(s) continue at the address shown [#-XY].
 # = Sheet Number (3-5), X = Column Grid, Y = Row Grid

5

4

3

2

1

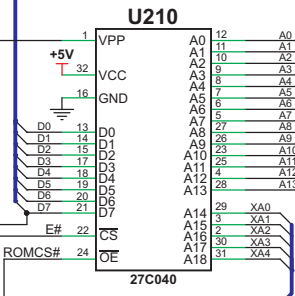
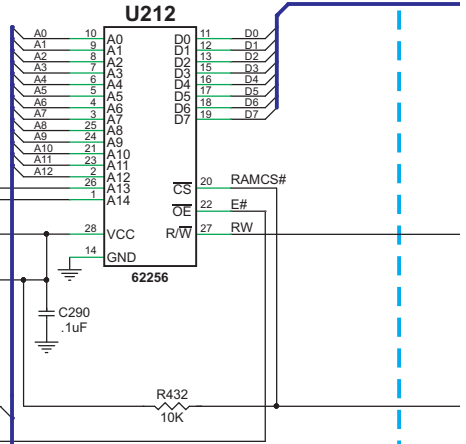
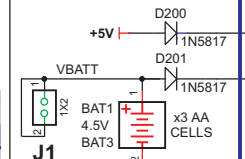
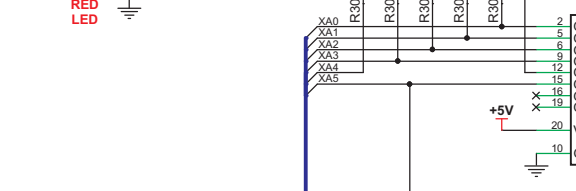
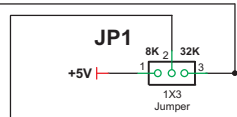
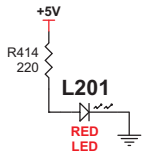

[2, C-5] E#

XA [5:0]

AVMA RW

AVMA RW

[2, C-4] E#

[2, H-3] BSEL

ROMCS#

XA0 BSEL

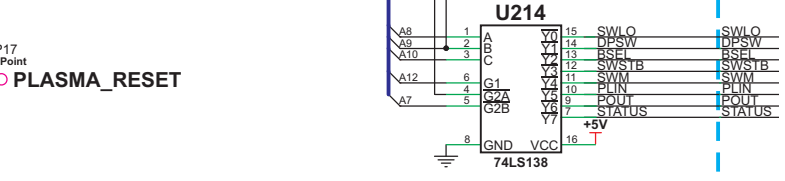
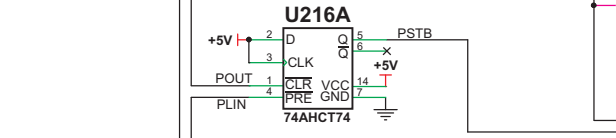
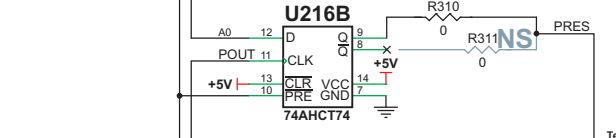
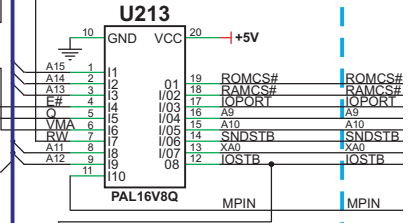
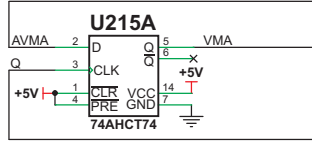
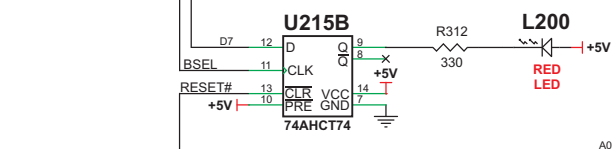

TP17 Test Point
 PLASMA_RESET

PRES BSEL PLIN RESET#

Sec. 5: PCBs

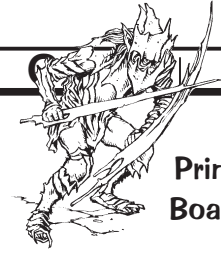

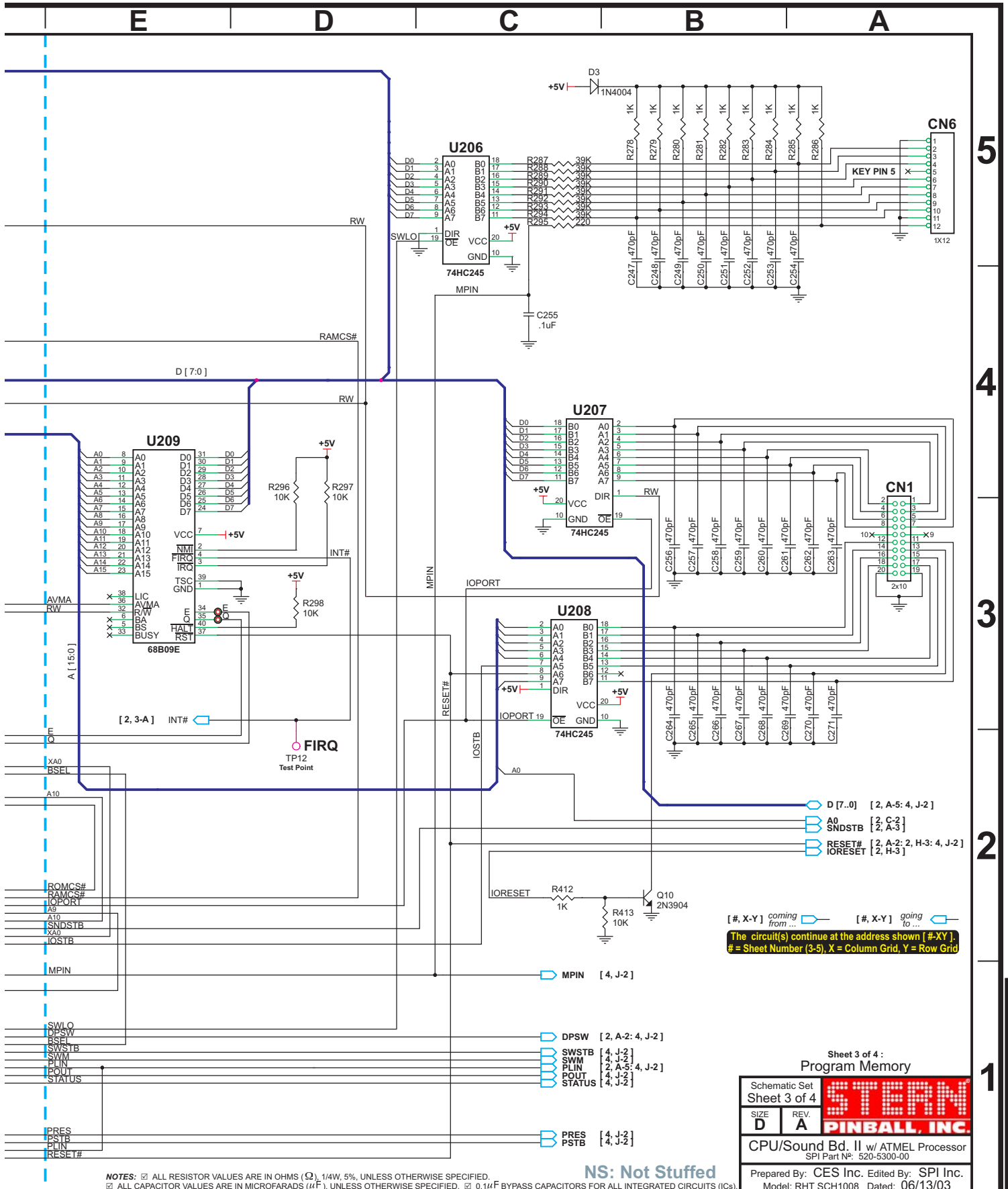

Sec. 5: PCBs



Sheet 3 of 4:
Program Memory

Schematic Set		STERN	
Sheet 3 of 4			
SIZE	REV	PINBALL, INC.	
D	A		
CPU/Sound Bd. II w/ ATMEL Processor			
SPI Part N ^o : 520-5300-00			
Prepared By: CES Inc.		Edited By: SPI Inc.	
Model: RHT SCH1008		Dated: 06/13/03	

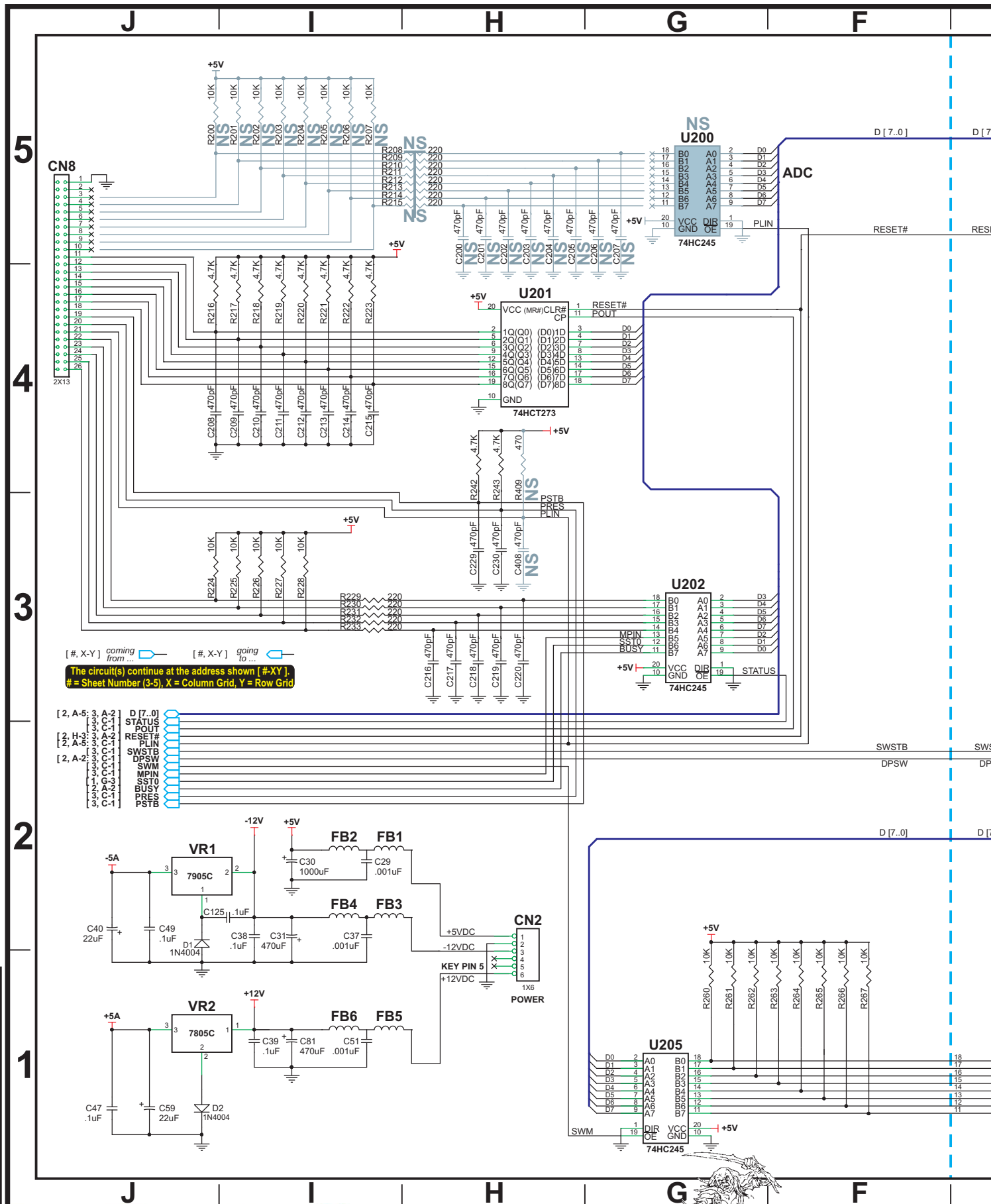

Sec. 5: PCBs

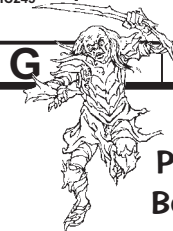

CPU/Sound Board II (with ATMEL Processor) Component Layout

Test Points (TP):



← VBATT [3, G-4]

← JPI [3, H-5]

← PLASMA_RESET TP17: [3, H-1]

← FIRQ TP12: [3, D-2]

← GND
← S2 RESET [2, J-3]
SW200

← LEDs
← L201 / L200 [3, J-5] & [3, H-2]
← GND

← Q TP5: [2, C-5]

← E TP7: [2, C-5]

← P2, PI, PO TP4, TP3, TP2: [2, D-5]

← U402 TP20: [1, J-2]

← JP3 [1, G-5]

← JP2 [1, G-1]

← U219 TP8: [2, H-4]

← LED1 [2, G-5]

← JTAG J3 [1, I-5]

← GND

← JP4 [1, E-3]

← JTAG J2 XILINX [2, C-1]

← LED2 [2, I-5]

← +3.3V TP1: [2, I-5]

← GND_SIGNAL

← AOL & AOR TP16: [1, C-1], TP11: [1, D-4]

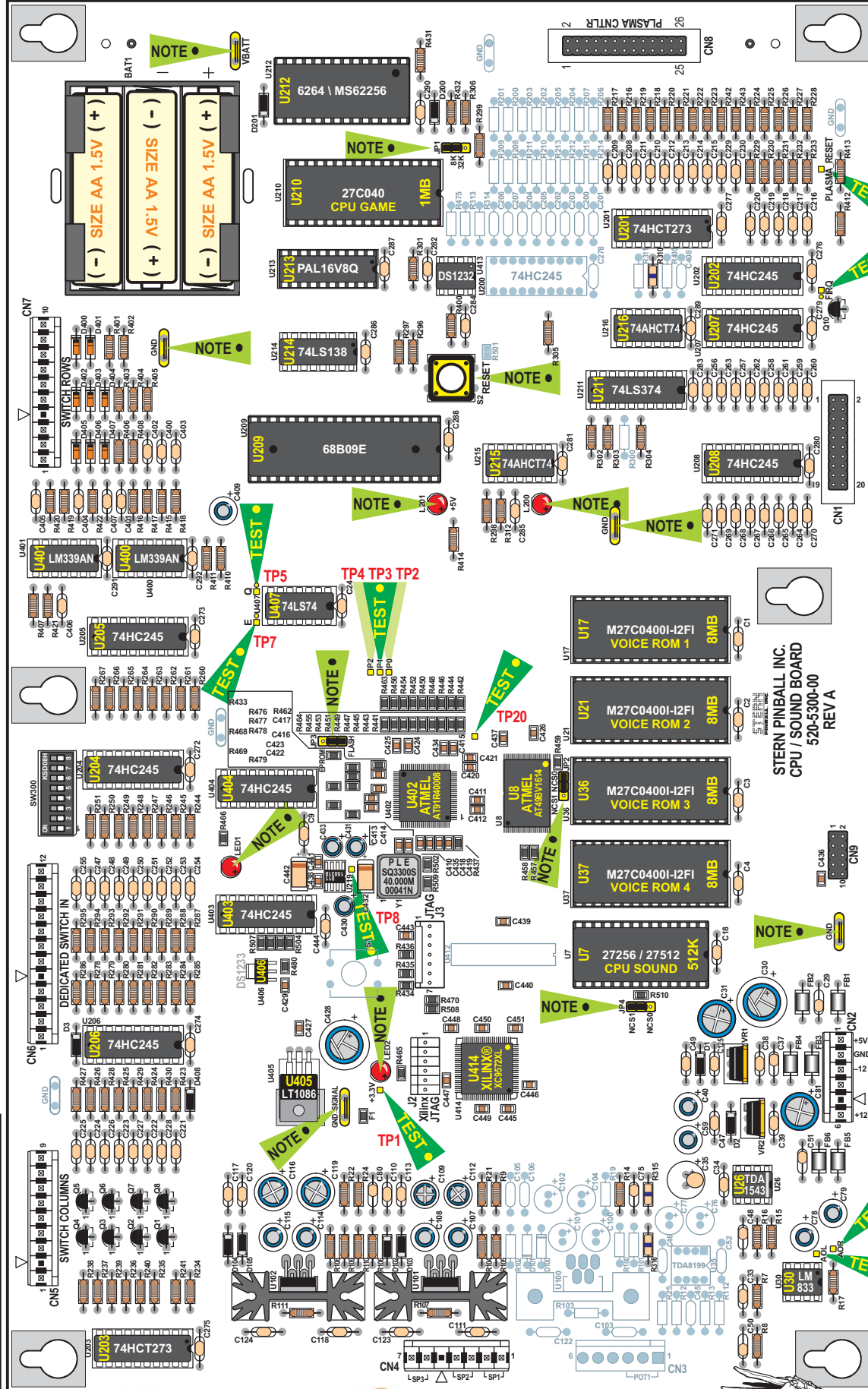

Actual Board Size
14.87" X 9.125"

Sec. 5: PCBs



CPU/Sound II Board (with Atmel Processor) Parts

ITEM	QTY	PART NUMBER	REF-DESIGNATOR	DESCRIPTION (NS = Not Stuffed)
			CPU/Sound II Board (with Atmel Processor)	Complete PCB Assembly
01	4	520-5300-00	JP1, JP2, JP3, JP4	3-Pin Jumper & 2-Pin Cover
02	1		CN2 (Key Pin-5)	6-Pin, 6PKK156
03	1	045-5015-06	J2 JTAG Xilinx®	6-Pin, Header
04	1	045-5015-07	CN4 (Key Pin-5)	7-Pin, 7PKK156
05	1		J3 JTAG	7-Pin, Header
06	1	045-5013-00	CN5 (Key Pin-2)	9-Pin, 9PKK156
07	1		CN9	10-Pin, 0.1 Header
08	1	045-5014-01	CN7 (Key Pin-4)	10-Pin, 10PKK156
09	1	045-5015-00	CN6 (Key Pin-5)	12-Pin, 12PKK156
10	1	045-5015-01	CN1	20-Pin, 0.1 Header
11	1	045-5015-26	CN8	26-Pin, 0.1 Header
12	3	125-5043-00	C29, C37, C51	0.001uF (102), Cap.
13	4	125-5039-00	C48, C50, C75, C80	0.0022uF or 2200pF, (222), Cap.
14	8	125-5029-00	C221>C228	0.01uF (103), 100v Cap.
15	52	125-5031-00	C1>C4, C9, C18, C24, C33, C34, C38, C39, C47, C49, C110, C111, C113, C117, C118, C120, C123, C124, C125, C255, C272>C277, C279>C292, C400>C407, C444 (C45, C46, C52, C103, C105, C106, C122, C278: NS)	0.1uF (104), Axial Cer. Cap.
16	3		C430, C431, C433 (near U403, U404)	1.0uF, v. Radial Lytic Cap.
17	1	125-5017-00	C35	10uF, 16v, Radial Tant. Cap.
18	4	125-5017-00	C78, C79, C107, C114 (C76, C77, C100: NS)	10uF, 25v-35v, Radial Lytic Cap.
19	2	125-5015-00	C109, C112 (C102, C104: NS)	100uF, 25v, Radial Lytic Cap.
20	1	125-5014-00	C409	22uF, 16v, Radial Lytic Cap.
21	4	125-5020-00	C40, C59, C108, C115 (C101: NS)	22uF, 25v, Radial Lytic Cap.
22	2	125-5012-00	C116, C119	220uF, 25v, Radial Lytic Cap.
23	2	125-5019-00	C31, C81	470uF, 25v, Radial Lytic Cap.
24	39	125-5028-00	C208>C215, C216>C220, C229, C230, C247>C254, C256>C263, C264>C271 (C200>C207, C408: NS)	470pF (471), Cer. Cap.
25	2	125-5037-00	C30, C428	1000uF, 16v, Radial Lytic Cap.
26	17		C427, C429, C436>C441, C443, C445>C451	SMT .1uF Cap.
27	2		C432, C442 (near U403 & U404)	SMT 10uF Cap.
28	9		C411, C414, C416, C419, C420, C422, C424, C434, C435	SMT 47pF Cap.
29	10		C410, C412, C413, C415, C417, C418, C421, C423, C425, C426	SMT 100nF Cap.
30	7	112-5003-00	D1>D3, D102>D105, D408 (D100, D101: NS)	1N4004, Diode
31	2	112-5008-00	D200, D201	1N5817, Diode
32	8	112-0054-00	D400-D407	1N1418, Diode
33	4	165-5099-00	LED1, LED2, L200, L201	LED T1-3/4 DIFFUSER LED
34	3	124-5064-00	R310, R315, R316 (R300, R311, R313, R314, R475: NS)	0Ω Jumper Res. (1-Stripe)
35	2	121-5041-00	R107, R111 (R103: NS)	1 Ω 1/4W Res.
36	1	121-5009-00	R8, R15, R234>R241, R278>R286, R412	1K Ω 1/4W Res.
37	2	121-5018-00	R7	1.5K Ω 1/4W Res.
38	2	121-5043-00	R16, R17 (R25, R112: NS)	2.2K Ω 1/4W Res.
39	2	121-5048-00	R410, R411	3.3K Ω 1/4W Res.
40	12	121-5021-00	R21, R216>R223, R242, R243, R400	4.7K Ω 1/4W Res.
	36	121-5011-00	R106, R224>R228, R244>R251, R260>R267, R296>R299, R301>R306, R413, R431, R432 (R200>R207, R501: NS)	10K Ω 1/4W Res.
41	3	121-5023-00	R9, R14, R104 (R100, R102: NS)	22K W 1/4W Res.
42	1	121-5022-04	R110	33K Ω 1/4W Res.
43	9	121-5045-00	R108, R287>R294	39K Ω Res.
44	2	121-5032-00	R22, R24	47K Ω 1/4W Res.
45	15	121-5014-00	R229>R233, R295, R414>R422 (R208>R215: NS)	220 Ω 1/4W Res.
46	1	121-5036-00	R312	330 Ω 1/4W Res.
47	2	121-5046-01	R105, R109 (R101, R409: NS)	470 Ω 1/4W Res.
48	16	121-5047-00	R401>R408, R423>R430	560 Ω 1/4W Res.
49	1		F1	SMT Res.
50	4		R434, R435, R436, R508	SMT 1K Ω Res.
51	1		R480	SMT 10K Ω Res.
52	2		R502, R509	SMT 33 Ω Res.
53	3		R465, R466, R470	SMT 100 Ω Res.
54	35		R433, R437, R441>R459, R462>R464, R468, R469, R476>R479, R504>R507, R510	SMT 100K Ω Res.
55	9	110-0069-00	Q1-Q8, Q10	2N3904, Transistor
56	1		U402	ATMEL , AT91R40008
57	1		U8	ATMEL , AT49BV1614
58	1		U414	XILINX® , XC9572XL
59	1		U7	512K EPROM Sound (27512)
60	1	(See Pg. DR. Ⓢ Table)	U210 (32-Pin, IC Socket, 077-5217-00)	1MB EPROM CPU Game (27C040)
61	4	(See Pg. DR. Ⓢ Table)	U17, U21, U36, U37 (32-Pin, IC Socket, 077-5217-00)	8MB EPROM Voice 1-4 (M27C04001-12FI)
62	1	965-6504-00	U213 (BLUE DOT)	PAL16V8Q (Programmed) BLUE DOT
63	1	105-5046-00	U212 (28-Pin, IC Dip Socket, 077-5208-00)	6264/MS62256 (MS6264A) (28-Pin)
64	1	100-0189-01	U209 (40-Pin, IC Socket, 077-5209-00)	68B09E (40-Pin)
65	2	100-5015-00	U215, U216	74AHC74 (14-Pin)
66	8	100-0338-00	U202, U204, U205, U206, U207, U208, U403, U404 (U200: NS)	74HC245 (20-Pin)
67	2	100-5012-00	U201, U203	74HCT273 (20-Pin)
68	1	100-0037-00	U407	74LS74 (14-Pin)
69	1	100-0148-00	U214	74LS138 (16-Pin)
70	1	100-0064-00	U211	74LS374 (20-Pin)
71	1		U406	3.3v Watchdog, DS1233 (3-Pin)
72	1	100-5023-00	U413	5.0v Watchdog, DS1232 (8-Pin)
73	1		U219	1.8v Volt. Regulator LT1503 (8-Pin)
74	1		U405	3.3v Volt. Regulator LT1086 (3-Pin)
75	1	124-5002-00	VR1	-5v Regulator, LM7905CT
76	1	124-5001-00	VR2	+5v Regulator, LM7805CT
77	2	100-0377-00	U400, U401	LM339AN (14-Pin)
78	1	100-0375-00	U30	LM833 (8-Pin)
79	1	100-5018-00	U26	TDA1543 (8-Pin)
80	2	100-5016-20	U101, U102 (U100: NS)	TDA2030A (5-Pin)
81	1	140-0040-00	Y1	40MHz Clock PLE SQ3300S
82	1	181-5002-00	SW300	Dip Switch 8-Pos., (KSD08H Black)
83		n/a	FB1>FB6	Ferrite Bead
84		535-5000-10	HS2, HS3, (HS1: NS) (over U101, U102)	Heat Sink (AAVID 531102)
85	1		S2 (Reset)	Push-Button Switch (B3F4000)
86	1	545-5685-00	BAT1 HOLDER (Always replace all 3, Size AA 1.5v Cells, with new ones, when required)	

* Surface Mounts (SMT) are not listed.

* Surface Mounts (SMT) are not listed.

Test Point Wire (24ga.) Loops:
 VBATT, GND (near CN7),
 GND (near CN9), GND (near L200),
 GND_SIGNAL (near U405)

Test Point Pads:
 TP1>TP5, TP7, TP8, TP11,
 TP12, TP16, TP17, TP20

If a part is required where a part number is not provided, call Tech. Support (see back of cover).

Printed Circuit Boards (PCBs)



Sec. 5: PCBs

Playfield Switch Single OPTO Transmitter & Receiver Boards Schematic

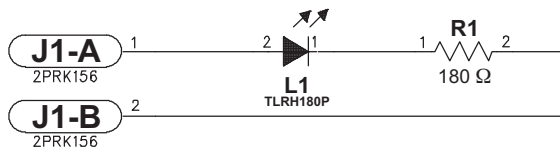

Single OPTO Transmitter
515-7307-00

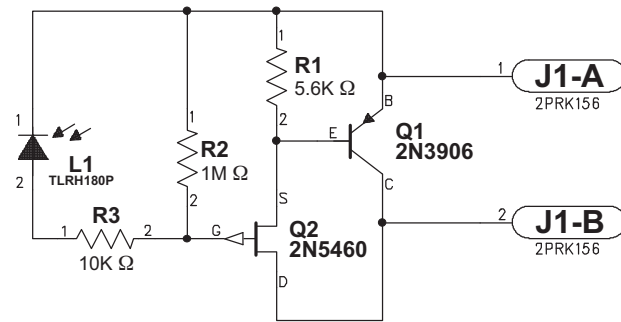

Single OPTO Receiver
515-7308-00

Playfield Switch Single OPTO Trans. & Rec. Boards Component Layout & Parts

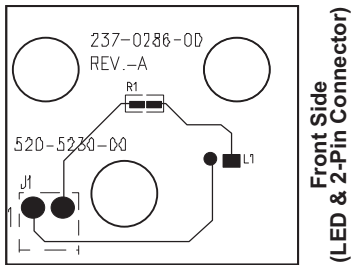

515-7307-00 (TRANS)

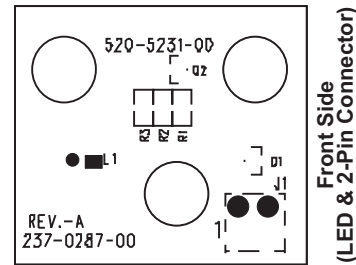

515-7308-00 (REC)

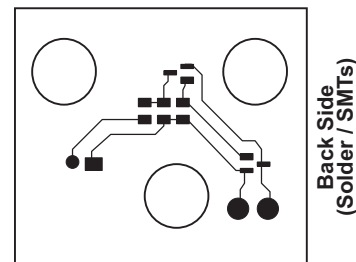
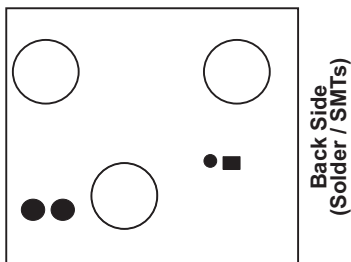

ITEM	QTY	PART NUMBER	REF-DESIGNATOR	DESCRIPTION
A	1	515-7307-00	Single OPTO Trans. Bd. Assy.	PCB Assy. (with all Items 1-5) PCB Assy. (with Items 1-3 only) 2X, .156" Rt. Angle (26-60-5020) Conn. LED TLRH180P (Ultra Bright Red) SMT 180 Ω 1/8W Chip Res. (CRCW) OPTO PCB Brass Tube Spacer OPTO PCB Rubber Grommet PCB Assy. (with all Items 1-9) PCB Assy. (with Items 1-7 only) 2X, .156" Rt. Angle (26-60-5030) Conn. LED TLRH180P (Ultra Bright Red) 2N3906, Transistor (P-FET SOT-23) 2N5460, Transistor SMT 5.6K Ω 1/8W Chip Res. (CRCW) SMT 1M Ω 1/8W Chip Res. (CRCW) SMT 10K Ω 1/8W Chip Res. (CRCW) OPTO PCB Brass Tube Spacer OPTO PCB Rubber Grommet
01	1	520-5230-00	Single OPTO Trans. Board	
02	1	165-5052-00	J1	
03	1	121-5067-00	L1	
04	3	530-5308-02	R1	
05	3	545-5518-00	n/a	
B	1	515-7308-00	Single OPTO Rec. Bd. Assy.	
01	1	520-5231-00	Single OPTO Rec. Board	
02	1	165-5052-00	J1	
03	1	110-5006-00	Q1	
04	1	110-0086-00	Q2	
05	1		R1	
06	1		R2	
07	1	121-5011-00	R3	
08	3	530-5308-02	n/a	
09	3	545-5518-00	n/a	



Replacement Part:
LED TLRH180P
(T1-3/4 GaAlAs)
 SPI Part N^o:
165-5052-00

If a part is required where a part number is not provided, call Tech Support (see back of cover).

Sec. 5: PCBs



Back Panel Switch Mini OPTO Transmitter & Receiver Boards Schematic, Component Layout & Parts

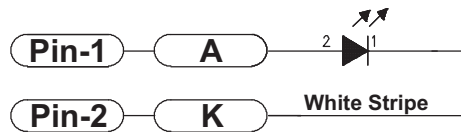
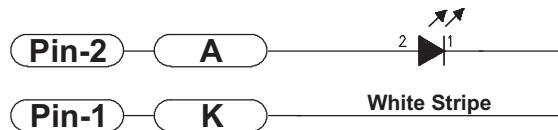

**Mini PCB
OPTO 12" Lead
(White Bracket)
500-6746-00**

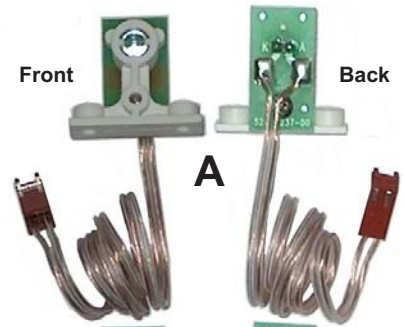

**Mini PCB
OPTO 6" Lead
(Black Bracket)
500-6747-00**

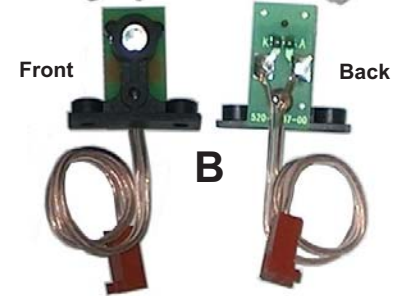

ITEM	QTY	PART NUMBER	REF-DESIGNATOR
A	1	500-6746-00	MINI PCB OPTO ASM WHT / 12" LEAD
—	1	520-5237-00	Mini OPTO Trans. or Rec. Board
01	1	545-6092-01	
02	1	237-5909-00	
03	1	165-5052-00	
04	1	601-5023-12	K, A
05	1	045-5020-02	Note White Strip to Pin-1
B	1	500-6747-00	MINI PCB OPTO ASM BLK / 6" LEAD
—	1	520-5237-00	Mini OPTO Trans. or Rec. Board
01	1	045-6092-00	
02	1	237-5909-00	
03	1	165-5052-00	
04	1	601-5023-06	K, A
05	1	045-5020-02	Note White Strip to Pin-2

DESCRIPTION
PCB Assy. (with all Items 1-5)
PCB Only Plain
White Bracket (Plastic) Holder
#4-40 X 1/4 PPH Screw
LED (Ultra Bright Red)
12" Speaker Wire (1-Side White Stripe)
2-Pin Cn., .100 KK Cmp Trm Molex 08-50-0113
PCB Assy. (with all Items 1-5)
PCB Only Plain
Black Bracket (Plastic) Holder
#4-40 X 1/4 PPH Screw
LED (Ultra Bright Red)
6" Speaker Wire (1-Side White Stripe)
2-Pin Cn., .100 KK Cmp Trm Molex 08-50-0113

Back Panel OPTO Transmitter / Receiver Amplifier Bd. Component Layout & Parts

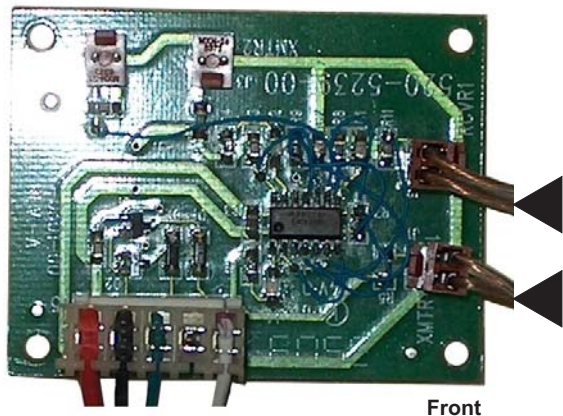

**OPTO
Transmitter /
Receiver
Amplifier PCB
520-5239-00**

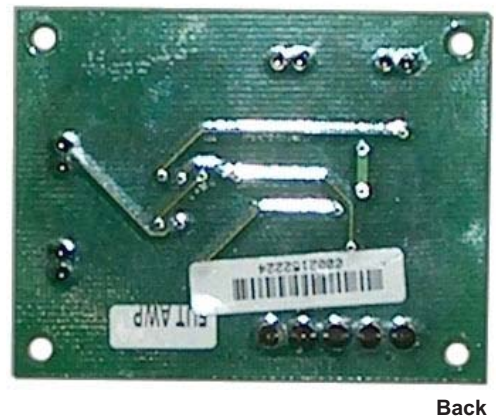

ITEM	QTY	PART NUMBER	REF-DESIGNATOR
—	1	520-5239-00	OPTO Transmitter/Receiver Amplifier Board
01	1		R7
02	2		R5, R6
03	1		R9
04	4		R1, R3, R12, R13
05	2		R10, R11
06	2		R2, R4
07	1		R8
08	3		C1, C2, C3
09	2		D1, D2
10	2		Q1, Q2
11	1		U1
12	4	Mfg. 22-23-2021	J1, J2, J3, J4
13	1	Mfg. 640445-5	J5
14	2	Mfg. APT3216SURC	L1, L2
15	4		n/a

DESCRIPTION
Complete PCB Assembly
SMT 150K Ω 1/10W Resistor 805, 5%
SMT 180 Ω 1/10W Resistor 805, 5%
SMT 180K Ω 1/10W Resistor 805, 5%
SMT 1K Ω 1/10W Resistor 805, 5%
SMT 1M Ω 1/10W Resistor 805, 5%
SMT 470 Ω 1/10W Resistor 805, 5%
SMT 6.8K Ω 1/10W Resistor 805, 5%
SMT Cer. .1uF 50v Cap., 10% X7R
1N4148W, Diode, 100v, 350MW
MMST3904, NPN, 40v, .02A
LM339M, Low Power Offset QUA
2-Pin, 0.1 Header (1 Row, VT, Tin)
5-Pin, .156 Header (1 Row, VT, Tin)
LEDD-SMT, Red 1206
Spacer (Nylon), .153" ID X 9/32" OD X 3/8"

Printed Circuit
Boards (PCBs)



Playfield 19-LED PCB Component Layout

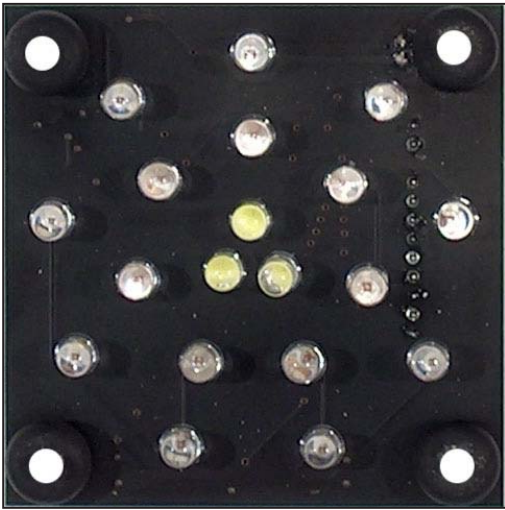

Front

19-LED PCB
520-5242-00

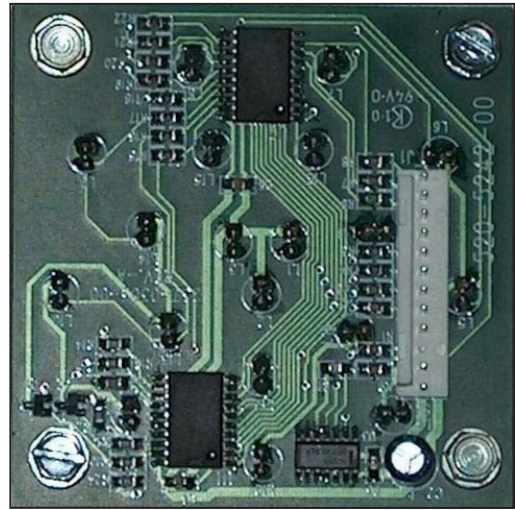

Back

Front

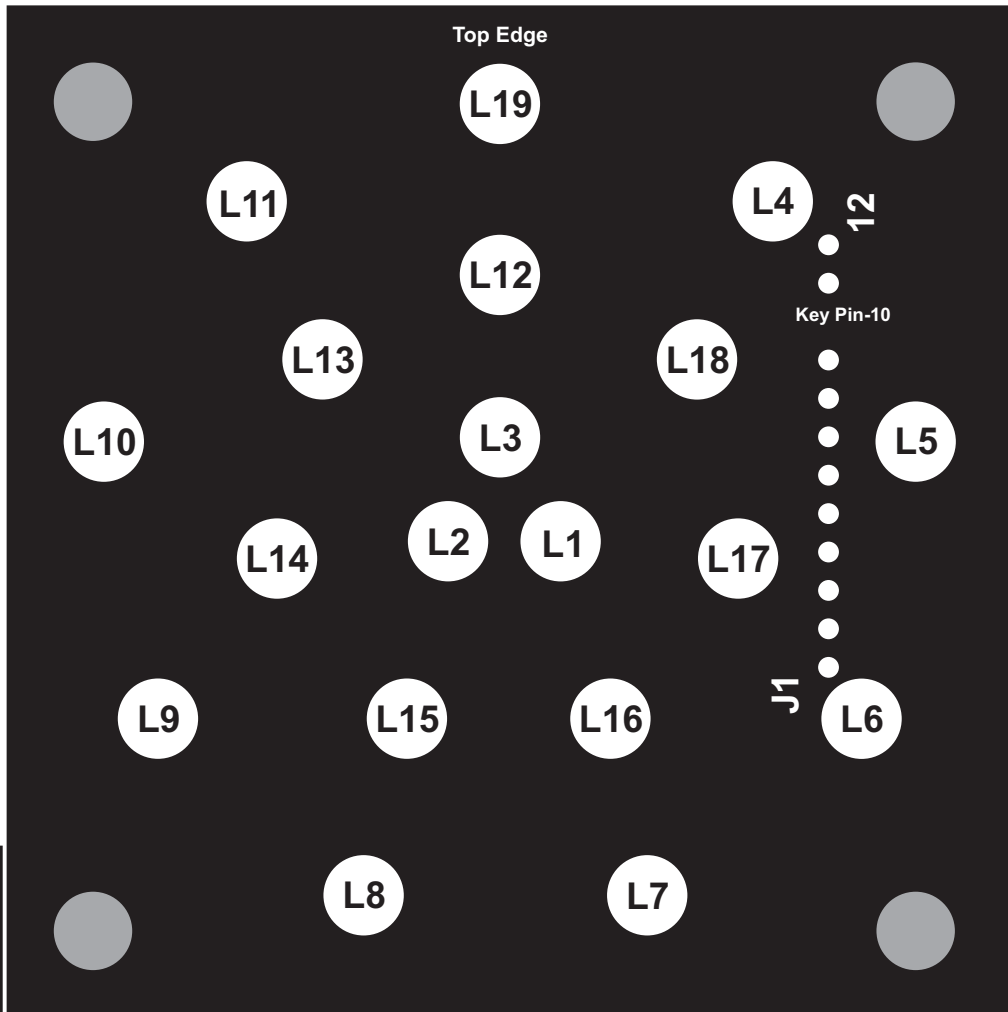

For Wiring, see
Pages 146 or 147.

Sec. 5: PCBs

ITEM	QTY	PART NUMBER	REF-DESIGNATOR	DESCRIPTION
—	1	520-5242-00	Playfield 19-LED PC Board	Complete PCB Assembly



UK & Special App. 3X Transistor Driver Bd. Schematic

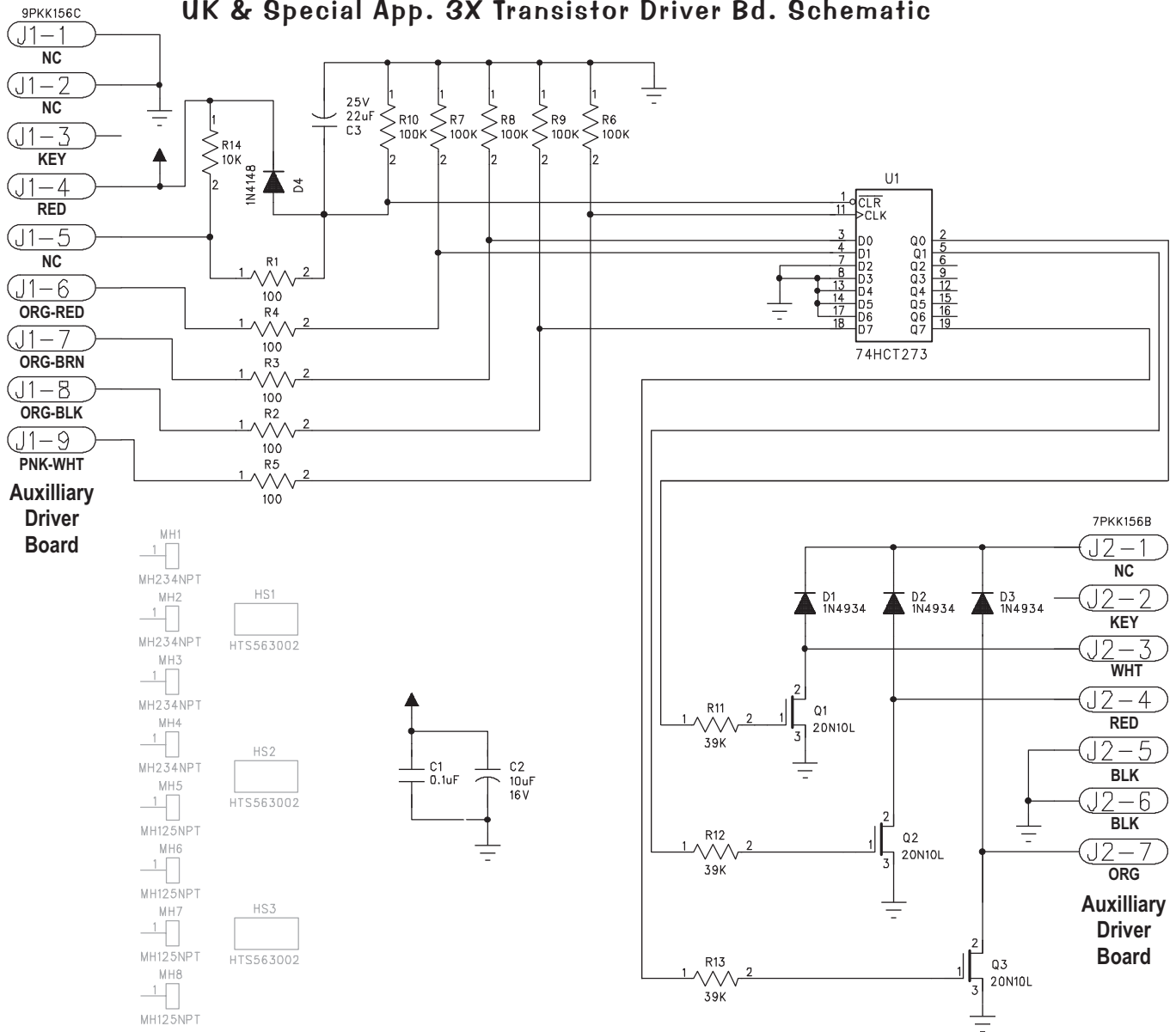

UK & Special App. 3X Transistor Driver Bd. Component Layout (Sol. Exp. Bd.)

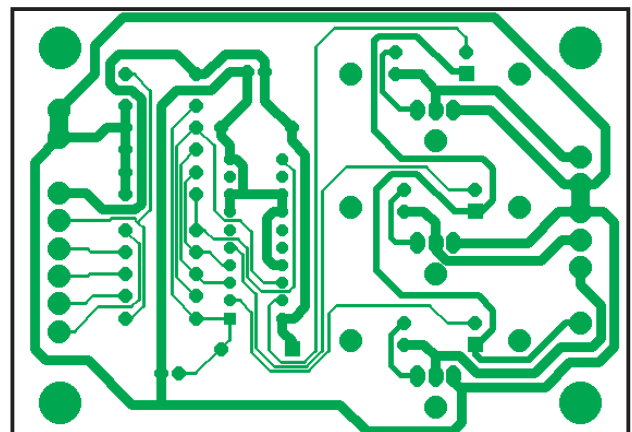
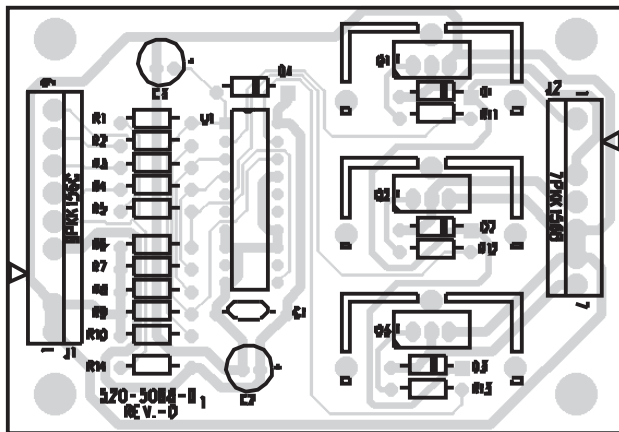

ITEM	QTY	PART NUMBER	REF-DESIGNATOR	DESCRIPTION
—	1	520-5068-01	Solenoid Expander (x3 Transistor) PC Board	Complete PCB Assembly



UK 3X Transistor Driver Board for Up-Posts & Playfield 19-LED Overview & Wiring

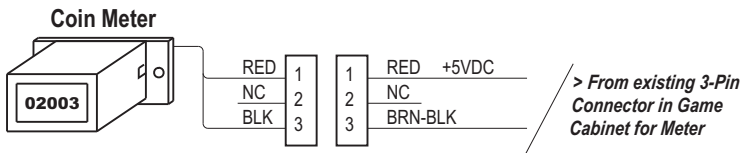
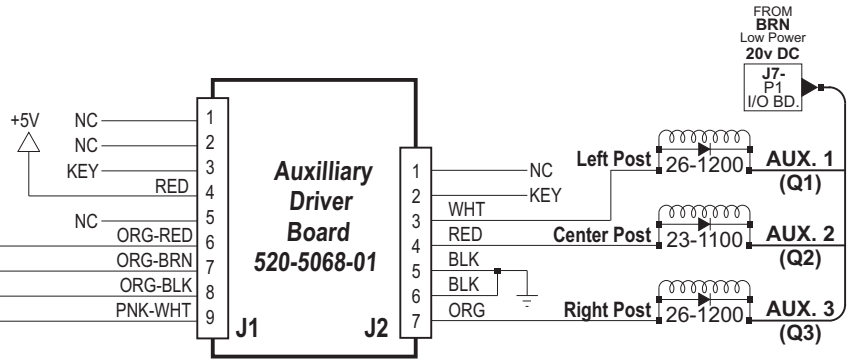
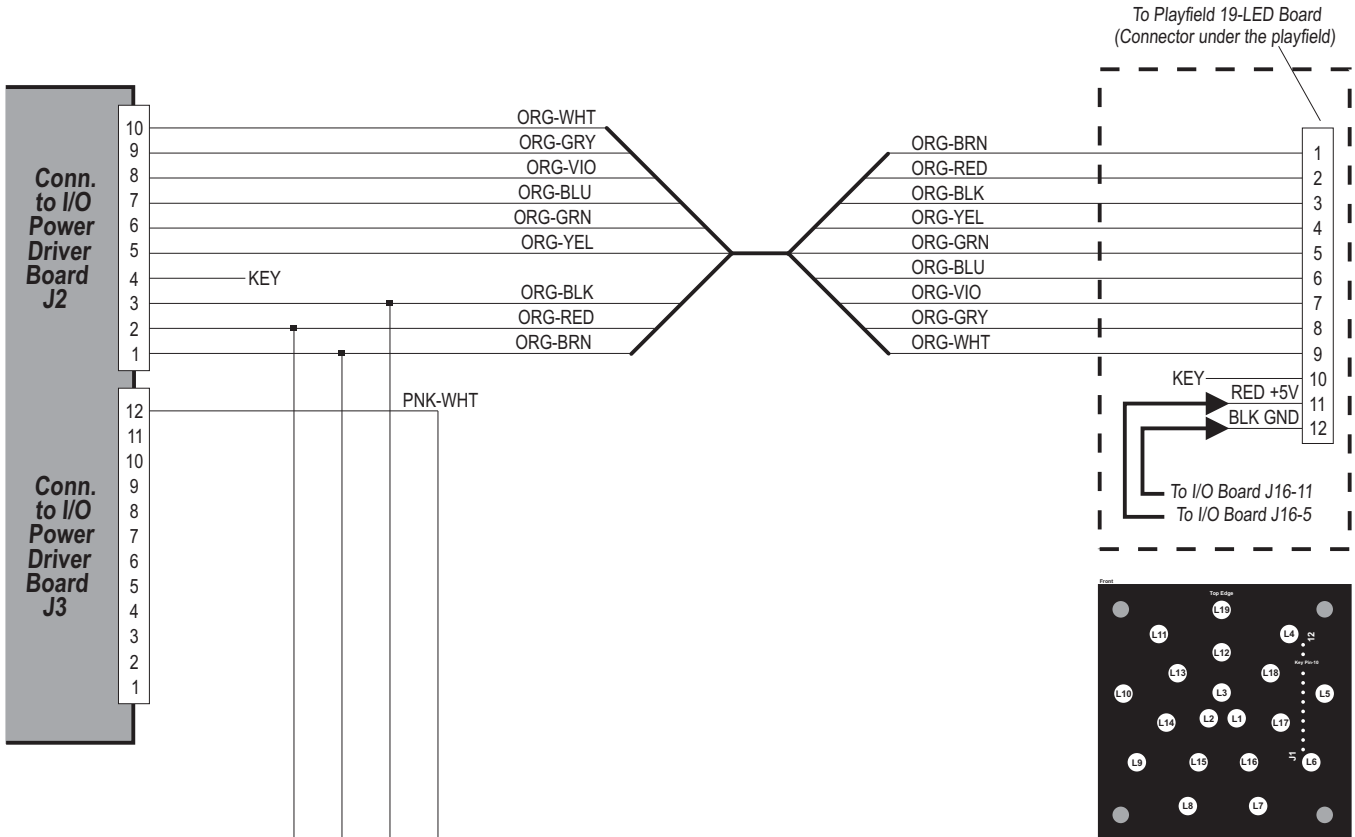

Sec. 5: PCBs

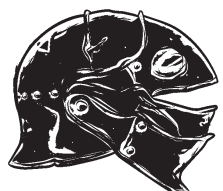

Printed Circuit Boards (PCBs)

UK 3X Transistor Driver Board for Up-Posts & Playfield 19-LED Overview & Wiring with the Tournament Serial Interface (TSI) Board

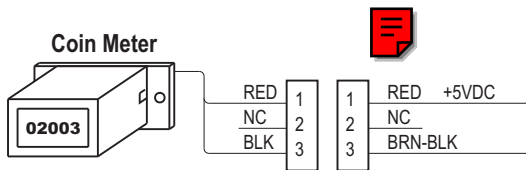
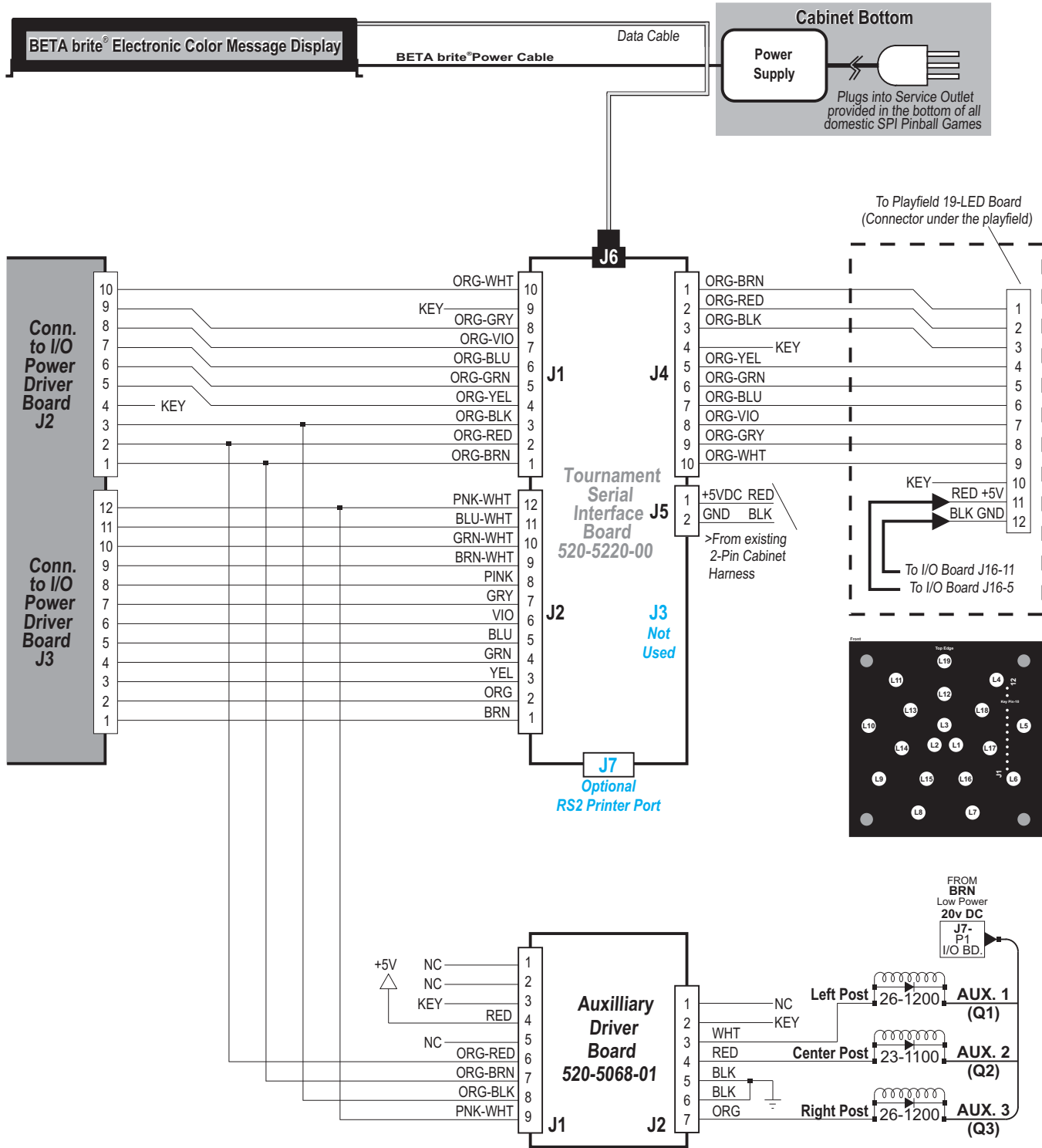

Printed Circuit Boards (PCBs)

Order the Optional ToPS™ (Tournament Pinball System) Kit!
Call Technical Support at 1-800-542-5377 for more information



THE LORD OF THE RINGS

Section 5, Chapter 4
Page 147

Sec. 5: PCBs

Tournament Serial Interface Board Schematic (Sheet 1 of 1)

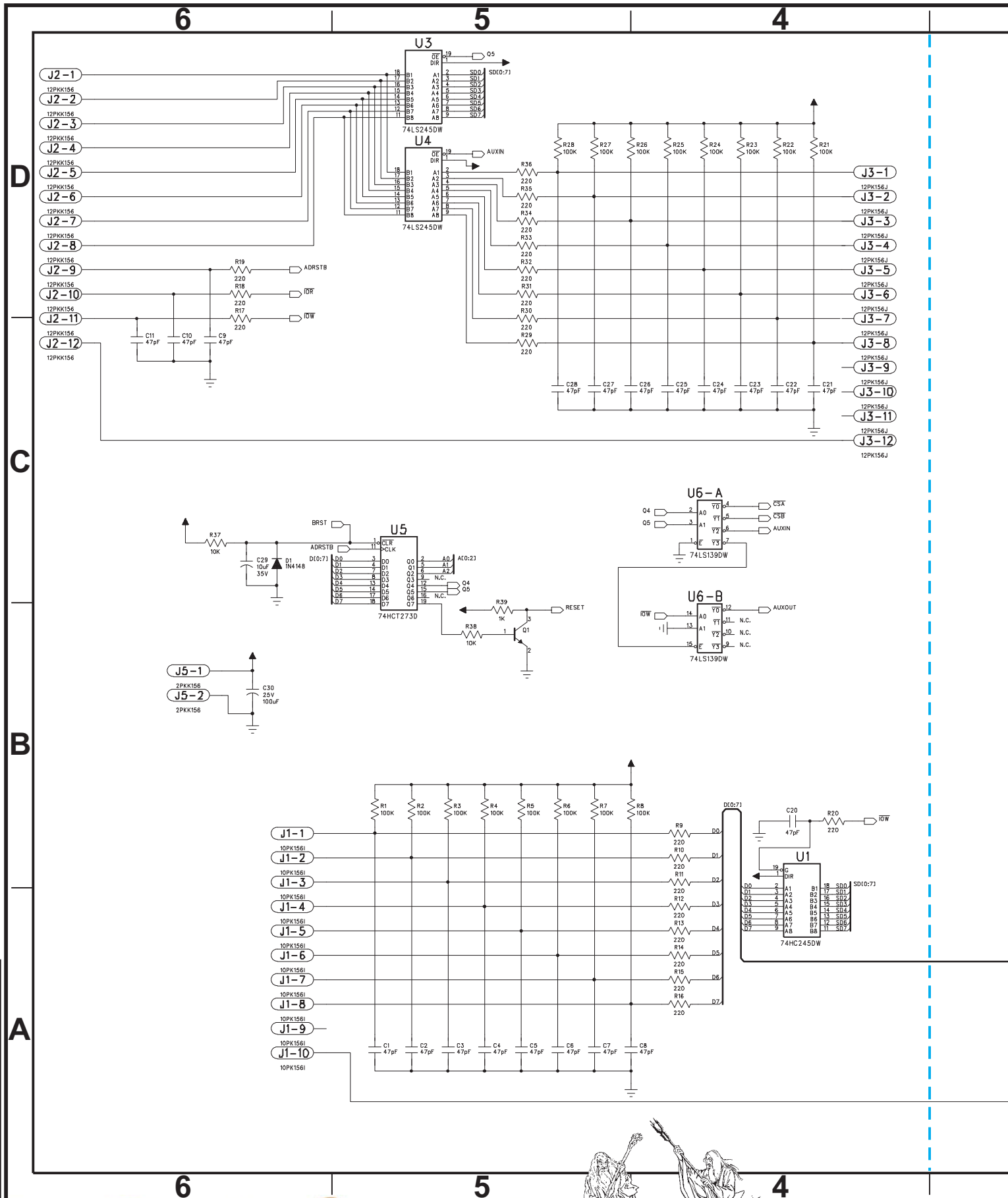

Sec. 5: PCBs



Tournament Serial Interface Board Schematic (Sheet 1 of 1)

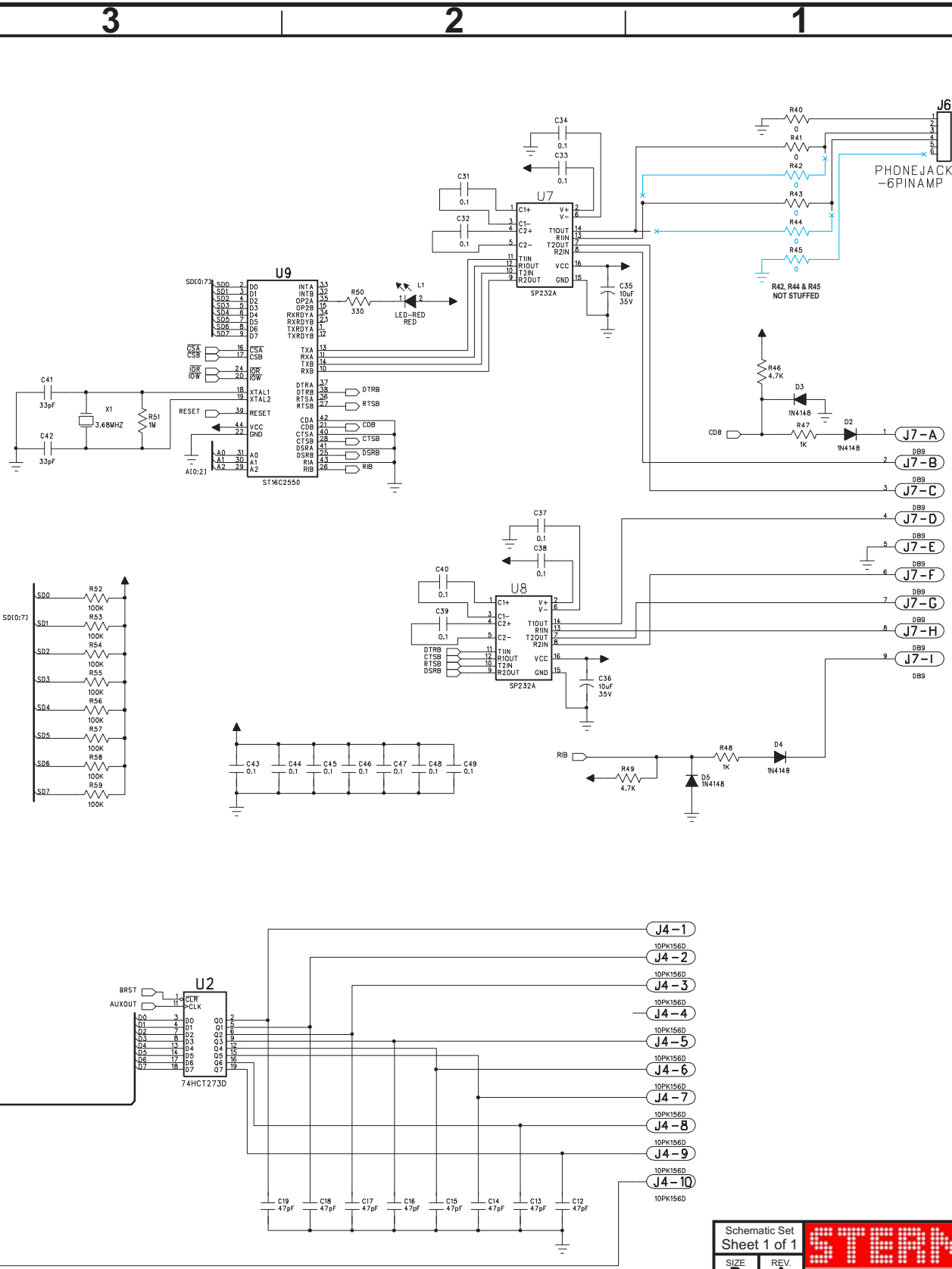

NOTES:
 [X] ALL RESISTOR VALUES ARE IN OHMS (Ω), 1/4W, 5%, UNLESS OTHERWISE SPECIFIED.
 [X] ALL CAPACITOR VALUES ARE IN MICROFARADS (μ F), UNLESS OTHERWISE SPECIFIED.
 [X] 0.1 MICROFARADS (μ F) BYPASS CAPACITOR ON ALL IC'S.

Non-Text Document

Schematic Set Sheet 1 of 1		STERN PINBALL, INC.
SIZE D	REV. A	
SPI Tournament Serial Interface Bd. SPI Part No: 520-5220-00		
Prepared By: CES Inc. Edited By: SPI Inc. Model: 237-0268-00 Dated: 08/2002		

Printed Circuit Boards (PCBs)

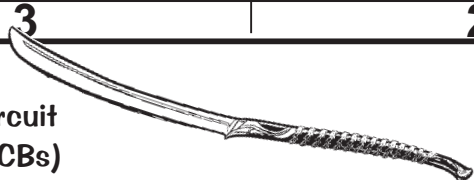

Sec. 5: PCBs

Tournament Serial Interface Board Component Layout

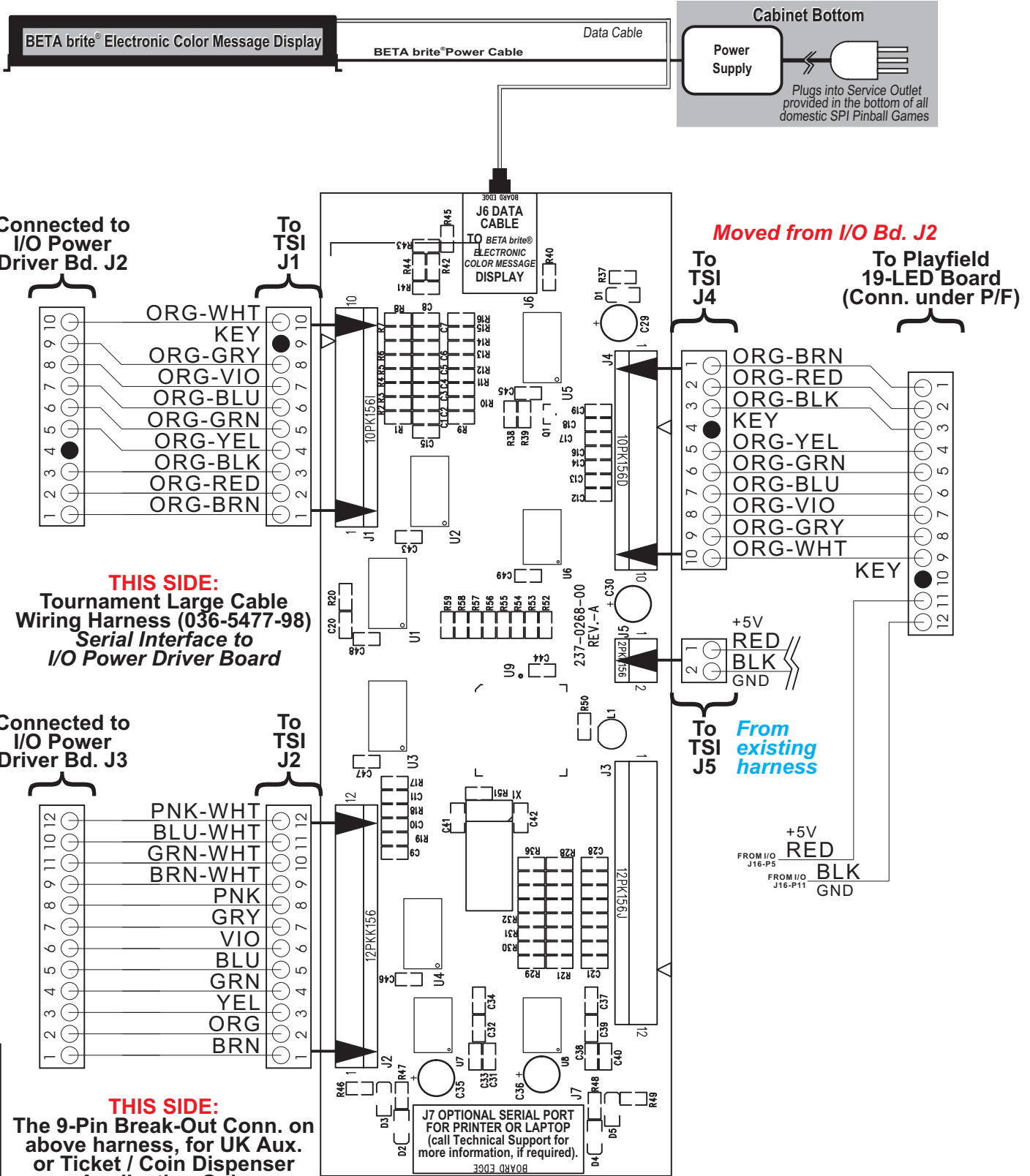

THIS SIDE:
Tournament Large Cable
Wiring Harness (036-5477-98)
Serial Interface to
I/O Power Driver Board

THIS SIDE:
The 9-Pin Break-Out Conn. on
above harness, for UK Aux.
or Ticket / Coin Dispenser
Application Only

Component Side

ITEM	QTY	PART NUMBER	REF-DESIGNATOR	DESCRIPTION
--	1	520-5220-00	Tournament Serial Interface (TSI) Board	PCB Assembly



Sec. 5: PCBs

Appendixes A through J

Table of Contents for Appendixes

- **Appendix A : Pinball Game Firmware TableA1-A2**
 - ▶ [White Star Board System and S.A.M. System Only*]
 - ▷ ... describes the ROM / Chip Size / Program & Raw Part Number / USA Version / Check Sum and CPU/Sound PCB I & II ROM locations for Games Apollo 13 — Grand Prix (White Star Games); World Poker Tour – current (S.A.M. Games).
- **Appendix B : Semi-Conductors / I.C.'s / Relays Cross-Reference Table B1**
 - ▷ ...describes diodes and transistors with Source Number, SPI Part Number, NTE Number, ECG Number, Radio Shack Number & RCA Part Number (If applicable).
- **Appendix C : Production Start Date, Manual Part N^o, ROM Size & Positions and Jumper W6 .. C1**
 - ▶ [White Star Board System and S.A.M. System Only*]
 - ▷ ...provides the Production Start Date, Manual Part Number, ROM Position(s), and Jumpers Installed for Games Apollo 13 — Grand Prix (White Star Games); World Poker Tour – current (S.A.M. Games).
- **Appendix D : Board TyPe Table D1-D2**
 - ▶ [White Star Board System and S.A.M. System Only*]
 - ▷ ...provides the Flipper**, I/O Power Driver, CPU/Sound, Display Power Supply, Dot Matrix Display, Display Controller, OPTOs and Misc. Board Part Numbers for Games Apollo 13 — Grand Prix (White Star Games); World Poker Tour – current (S.A.M. Games). ***Flipper Bd. with White Star Bd. System for A13 & Golden Eye only.*
- **Appendix E : Generic Coil Cross-Reference Guide & Flipper Coil TableE1-E2**
 - ▶ [White Star Board System and S.A.M. System Only*]
 - ▷ ...provides the Coils used with Part Number and Gauge-Turns (of the coil) for Games Apollo 13 — Grand Prix (White Star Games); World Poker Tour – current (S.A.M. Games).
- **Appendix F : Motor Specification Table F1-F2**
 - ▶ [White Star Board System and S.A.M. System Only*]
 - ▷ ...provides all the Motor Function, Specifications and Part Number for Games Apollo 13 — Grand Prix (White Star Games); World Poker Tour – current (S.A.M. Games)..
- **Appendix G : Part Number Prefix Classification Codes G1**
 - ▷ ...explains how our Part Numbers are developed to help sort parts easier.
- **Appendix H : Playfield Inserts (Plastic Light Covers) H1**
 - ▷ ...gives a pictoral view with the name and Part Nr. of all the inserts used (with Color Code Chart).
- **Appendix I : Stand-Up Targets & Modular Stand-Up Targets I1-I2**
 - ▷ ...gives a pictoral view with the name and Part Number of all the Single Stand-Up Targets used (with Color Code Chart).
- **Appendix J : Coin Cards (USA & International) J1**
 - ▷ ...gives a pictoral view with the name and Part Number of all the current Coin Cards for USA, Canada, Euro and other International Countries. For all Coin Cards and/or free Coin Card files for download, visit our website : www.sternpinball.com



APPENDIX A

Pinball Game Firmware (White Star Board System* & S.A.M. System** Only) Table



See website for the latest International Code or Updated USA version / checksums

ROM	Chip Size	Program Part N°	USA Ver. & Check Sum	Bd. Loc.	Raw Part N°
Ripley's Believe It or Not!® (Notes 7, 8)					
Sound	(512K)	965-0408-81	1.00 \$D93D	U7	960-7001-02
Game ROM	(1M)	965-0409-81	A3.20 \$43FF	U210	960-5009-00
Voice 1	(8M)	965-0410-81	1.00	\$067B U17	960-5016-00
Voice 2	(8M)	965-0411-81	1.00	\$C8B8 U21	960-5016-00
Voice 3	(8M)	965-0412-81	1.00	\$64C2 U36	960-5016-00
Voice 4	(8M)	965-0413-81	1.00	\$5341 U37	960-5016-00
Display	(4M)	965-0414-81	A3.00 \$DE4B	U5 DC PCB	960-5015-01

Elvis® (Notes 7, 8)					
Sound	(512K)	965-0415-84	1.00 \$8CD2	U7	960-7001-02
Game ROM	(1M)	965-0416-84	A5.00 \$50FF	U210	960-5009-00
Voice 1	(8M)	965-0417-84	1.00	\$538D U17	960-5016-00
Voice 2	(8M)	965-0418-84	1.00	\$8BCD U21	960-5016-00
Voice 3	(8M)	965-0419-84	1.00	\$60F8 U36	960-5016-00
Voice 4	(8M)	965-0420-84	1.00	\$14D8 U37	960-5016-00
Display	(4M)	965-0421-84	A5.00 \$A1F6	U5 DC PCB	960-5015-01

The SopranosSM (Notes 7, 8)					
Sound	(512K)	965-0422-85	4.00 \$9B5A	U7	960-7001-02
Game ROM	(1M)	965-0423-85	A5.00 \$5BFF	U210	960-5009-00
Voice 1	(8M)	965-0424-85	3.00	\$F01E U17	960-5016-00
Voice 2	(8M)	965-0425-85	1.04	\$C14C U21	960-5016-00
Voice 3	(8M)	965-0426-85	1.04	\$47A3 U36	960-5016-00
Voice 4	(8M)	965-0427-85	1.04	\$ADCD U37	960-5016-00
Display	(4M)	965-0428-85	A5.00 \$B4BB	U5 DC PCB	960-5015-01

NASCAR® (Notes 7, 8)					
Sound	(512K)	965-0429-86	2.00 \$32B3	U7	960-7001-02
Game ROM	(1M)	965-0430-86	A4.50 \$39FF	U210	960-5009-00
Voice 1	(8M)	965-0431-86	2.00	\$CFFB U17	960-5016-00
Voice 2	(8M)	965-0432-86	2.00	\$22C0 U21	960-5016-00
Voice 3	(8M)	965-0433-86	2.00	\$5FC8 U36	960-5016-00
Voice 4	(8M)	965-0434-86	2.00	\$2902 U37	960-5016-00
Display	(4M)	965-0435-86	A4.00 \$92BD	U5 DC PCB	960-5015-01

Grand Prix (Notes 7, 8)					
Sound	(512K)	965-0429-91	V1.00 \$6F89	U7	960-7001-02
Game ROM	(1M)	965-0430-91	A4.50 \$5EFF	U210	960-5009-00
Voice 1	(8M)	965-0431-91	1.00	\$C0E5 U17	960-5016-00
Voice 2	(8M)	965-0432-91	1.00	\$F4C6 U21	960-5016-00
Voice 3	(8M)	965-0433-91	1.00	\$057D U36	960-5016-00
Voice 4	(8M)	965-0434-91	1.00	\$2646 U37	960-5016-00
Display	(4M)	965-0435-91	A4.00 \$DA8E	U5 DC PCB	960-5015-01

[NDSE] (Notes 7, 8) <i>Call for more info if code update required.</i>					
Sound	(512K)	965-0436-97		U7	960-7001-02
Game ROM	(1M)	965-0437-97		U210	960-5009-00
Voice 1	(8M)	965-0438-97		U17	960-5016-00
Voice 2	(8M)	965-0439-97		U21	960-5016-00
Voice 3	(8M)	965-0440-97		U36	960-5016-00
Voice 4	(8M)	965-0441-97		U37	960-5016-00
Display	(4M)	965-0442-97		U5 DC PCB	960-5015-01

**** GAMES BELOW THIS LINE / NEXT COLUMN ARE S.A.M. SYSTEM GAMES**

TO ORDER MEMORY STICK WITH GAME FILES FROM YOUR DISTRIBUTOR, USE SPI PART NUMBER 970-0128-00 & INCLUDE THE GAME NAME / LANGUAGE FILE(S) DESIRED.

World Poker Tour™ Pinball (WPT) (Notes 7, 9)					
Boot B-02	(8M)	965-BOOT-SAM	1.04 \$7E62	U9	960-5016-00 unprogrammed
Memory Stick 128MB (970-0128-00)		Version		System	Bin Files:
English + Spanish		1.12AL		1.17+	WPT0112AL.bin
English Only		1.12A		1.17+	WPT0112A.bin
English + French		1.12AF		1.17+	WPT0112AF.bin
French Only		1.12F		1.17+	WPT0112F.bin
German + French		1.12GF		1.17+	WPT0112GF.bin
German Only		1.12G		1.17+	WPT0112G.bin
English + Italian		1.12AI		1.17+	WPT0112AI.bin
Italian Only		1.12I		1.17+	WPT0112I.bin

NOTE: THE TYPICAL SIZE PER UNZIPPED BIN FILE IS 25MB – 30MB+/-

The Simpsons™ Kooky Carnival Redemption (Note 9)					
Boot B-02	(8M)	965-BOOT-SAM	1.04 \$7E62	U9	960-5016-00 unprogrammed
Memory Stick 128MB (970-0128-00)		Version		Bin Files:	
English Only		1.05		SKC0105.bin	
English New Jersey Only		0.09NJ		SKC0090NJ.bin	

NOTE: THE TYPICAL SIZE PER UNZIPPED BIN FILE IS 5.5MB +/-

©Disney's Pirates of the Caribbean Pinball (POTC) (Notes 7, 9)					
Boot B-02	(8M)	965-BOOT-SAM	1.06 \$2014	U9	960-5016-00 unprogrammed
Memory Stick 128MB (970-0128-00)		Version		System	Bin Files:
English + Spanish		1.15AS		1.17+	POTC115AS.bin
English + French		1.15AF		1.17+	POTC115AF.bin
German + French		1.15GF		1.17+	POTC115GF.bin
English + Italian		1.15AI		1.17+	POTC115AI.bin

NOTE: THE TYPICAL SIZE PER UNZIPPED BIN FILE IS 25MB – 30MB+/-

Family Guy™ Pinball (FG) (Notes 7, 9)					
Boot B-02	(8M)	965-BOOT-SAM	2.09 \$10A3	U9	960-5016-00 unprogrammed
Memory Stick 128MB (970-0128-00)		Version		System	Bin Files:
English + Spanish		10.00AL		1.23+	FG1000AL.bin
English + French		10.00AF		1.23+	FG1000AF.bin
English + German		10.00AG		1.23+	FG1000GF.bin
English + Italian		10.00AI		1.23+	FG1000AI.bin

NOTE: THE TYPICAL SIZE PER UNZIPPED BIN FILE IS 25MB – 30MB+/-

Spider-Man™ Pinball (S-M) (Notes 7, 9)					
Boot B-02	(8M)	965-BOOT-SAM	2.10 \$F625	U9	960-5016-00 unprogrammed
Memory Stick 128MB (970-0128-00)		Version		System	Bin Files:
English + Spanish		1.3ES		1.27+	spd_1_30_es.bin
English + French		1.3EF		1.27+	spd_1_30_ef.bin
German + French		1.3GF		1.27+	spd_1_30_gf.bin
English + Italian		1.3EI		1.27+	spd_1_30_ei.bin

NOTE: THE TYPICAL SIZE PER UNZIPPED BIN FILE IS 25MB – 30MB+/-

footnotes:

- 1 ROMs on CPU/Sound Bd.: 520-5136-00 (Stereo) & Display Cont. Bd.: 520-5055-01
- 2 ROMs on CPU/Sound Bd.: 520-5136-10 (Mono) & Display Cont. Bd.: 520-5055-01
- 3 ROMs on CPU/Sound Board: 520-5136-15* (Mono) (*FCC 11-97) & Display Controller Board: 520-5055-02* (*FCC 11-97)



APPENDIX B

Semi-Conductors / Integrated Circuits (I.C.) / Relays Cross-Reference Table

Table No	Type	Source Number	STERN® PINBALL	NTE®	ECG®	Radio Shack®	RCA®
RECTIFICATION, BLOCKING, DAMPENING DIODES AND/OR LIGHT EMITTING DIODES (LEDs)							
1	Diode	1N4001	112-5001-00	NTE552	ECG552	- - - - -	SK9000
	Diode	1N4004	112-5003-00	NTE116	ECG116	276-1103	SK3312
	Diode	1N5401	112-0056-00	NTE5801	ECG5801	276-1143	SK9004
	Diode	1N5404	112-5004-00	NTE5804	ECG5804	276-1144	SK9007
	Diode	T6A10L	112-5006-01	NTE5812	ECG5812	- - - - -	- - - - -
	Diode	FR302	112-5009-00	NTE588	ECG588	- - - - -	SK5014
	Diode, Signal	1N914	112-5014-00	- - - - -	- - - - -	- - - - -	- - - - -
	LED	MT5000UR or TLRH180P (T1-3/4 GaAlAs)	165-5052-00 <i>(old SPI Part No: 165-5100-00)</i>	- - - - -	- - - - -	276-066B	- - - - -
ZENER DIODES							
2	Diode	1N4742A 12v	112-0061-00	NTE142A	ECG142A	276-563	SK12V
	Diode	1N4760B 68v	112-0062-00B	NTE5092A	ECG5092A	- - - - -	SK68V
	Diode	1N4764A 100v	112-0049-00A	NTE5096A	ECG5096A	- - - - -	SK100V
	Diode	1N5228 3.9v	112-0053-00	NTE5007A	ECG5007A	- - - - -	SK3A9
	Diode	1N5234B 6.2v	112-0047-00B	NTE5013A	ECG5013A	276-561	SK6A2
	Diode	1N5379 110v	112-0072-00	NTE5157	ECG5157	- - - - -	SK110X
	Diode	1N6267A 6.8v	112-5011-00	NTE4902	ECG4902	- - - - -	- - - - -
	Diode	1N4752A 33v	112-5010-00A	NTE147A	ECG147A	- - - - -	SK33V
	Diode	1N4736 6.8v 1w	112-5007-00	NTE5071A	ECG5071A	- - - - -	- - - - -
TRANSISTORS - TYPE FET, NPN, PNP AND/OR SCR							
3	FET Trans.	STP20N10L	110-0106-00	NTE2987	ECG2987	- - - - -	- - - - -
	FET Trans.	STP19N06L	110-0088-00	NTE2985	ECG2985	- - - - -	- - - - -
	FET Trans.	VN02N	110-0089-00	- - - - -	- - - - -	- - - - -	- - - - -
	NPN Trans.	2N4401	110-0073-00	NTE85	ECG85	276-2009	SK3124A
	NPN Trans.	2N6427	110-0070-00	NTE48	ECG48	- - - - -	SK4906
	NPN Trans.	MJE340	110-0071-00	NTE157	ECG157	- - - - -	SK3747
	NPN Trans.	MPSA42	110-0082-00	NTE287	ECG287	- - - - -	SK3232
	NPN Trans.	2N3904	110-0069-00	NTE123AP	ECG123AP	276-2009	- - - - -
	NPN Trans.	TIP122	110-0067-00	NTE261	ECG261	276-2068	SK3896
	NPN Trans.	MJE15030	110-0101-00	NTE375	ECG375	- - - - -	SK9118
	PNP Trans.	2N5401	110-0078-00	NTE288	ECG288	- - - - -	SK3434
	PNP Trans.	MJE15031	110-0103-00	NTE292	ECG292	- - - - -	SK3441
	PNP Trans.	MJE350	110-0072-00	NTE374	ECG374	- - - - -	SK9042
	PNP Trans.	MPSA92	110-0100-00	NTE288	ECG278	- - - - -	SK3434
	PNP Trans.	TIP42	110-0068-00	NTE332	ECG332	- - - - -	SK9236
	PNP Trans.	TIP32C	110-0081-00	NTE292	ECG292	- - - - -	SK3441
	PNP Trans.	TIP36C	110-0077-00	NTE393	ECG393	- - - - -	SK3961
	SCR Trans.	2N5060	110-0074-00	NTE5400	ECG5400	276-1067	SK3950
SCR Trans.	SCR2800B	110-0083-00	NTE5461-8	ECG5461-8	- - - - -	- - - - -	
BRIDGE RECTIFIERS (BR)				Comments:			
4	BR (Present)	DB3501 or CM3501	112-5000-00	For White Star I/O Bds., BR = 35 Amp @ 100v P.I.V.			
	RELAYS				Comments:		
5	Relay	FRL-264 D024/02CK	190-5002-00	For PPB, Power Supply, & White Star I/O Boards, Relay = 24v DC 10 Amp DPDT			
	Relay	FRL-264 D006/04CV	190-5001-00	For CPU Boards, Relay = 6v DC 5 Amp 4 Pole DT			





APPENDIX C

Production Start Date, Manual Part No., ROM Size & Positions and Jumper W6 Installed Note‡ (White Star Board System & S.A.M. System Only*)



Game Name White Star Bd. System™	Production Start Date and Manual Part Nr.	CPU/Sound Board Sound U7 512K CPU/Sound Board Game U210 1MB CPU/Sound Board Voice ROMS:				Jumper Installed (‡ see Note)	
		U17	U21	U36	U37		
<p>* Note: For complete Appendix Information for Games <i>Laser War</i> through <i>Batman Forever</i>, see any Service Game Manual between <i>Apollo 13</i> through <i>Ripley's Believe It or Not!</i> or on-line at our website www.sternpinball.com/parts.htm; also available on CD-R, 970-2003-00 (<i>The Simpsons™ Pinball Party</i>, <i>T3®</i> and <i>The Lord of the Rings™</i>).</p>							
29	Apollo 13 (A13)	NOV 95 780-5044-00	4MB	4MB	4MB	Not Used	n / a
30	Golden Eye	FEB 96 780-5042-00	4MB	4MB	Not Used	Not Used	n / a
31	Twister	APR 96 780-5041-00	4MB	4MB	Not Used	Not Used	n / a
32	ID4: Independence Day	JUL 96 780-5045-00	4MB	4MB	Not Used	Not Used	n / a
33	Space Jam	OCT 96 780-5043-00	4MB	4MB	4MB	Not Used	n / a
34	The Star Wars Trilogy - Sp. Ed.	FEB 97 780-5056-00	4MB	4MB	Not Used	Not Used	n / a
35	The Lost World: Jurassic Park	JUN 97 780-5053-00	4MB	4MB	Not Used	Not Used	n / a
36	The X-Files	AUG 97 780-5046-00	4MB	4MB	Not Used	Not Used	n / a
37	Starship Troopers	NOV 97 780-5059-00	4MB	4MB	4MB	Not Used	n / a
38	Viper Night Drivin'	FEB 98 780-5035-00	4MB	4MB	4MB	4MB	n / a
39	Lost In Space	JUN 98 780-5060-00	4MB	4MB	4MB	4MB	n / a
40	Godzilla	SEP 98 780-5040-00	4MB	4MB	4MB	4MB	n / a
41	South Park	JAN 99 780-5071-00	8MB	8MB	8MB	8MB	W6
42a	Harley-Davidson®	AUG 99 780-5067-01	8MB	8MB	8MB	8MB	W6
42b	Harley-Davidson® 2nd Ed.	SEP 02 780-5067-10	8MB	8MB	8MB	8MB	W6
42c	Harley-Davidson® 3rd Ed.	OCT 04 780-5087-00	8MB	8MB	8MB	8MB	W6
43a	Striker Xtreme	MAR 00 780-5068-01	8MB	8MB	8MB	8MB	W6
43b	NFL	OCT 00 780-5073-00	8MB	8MB	8MB	8MB	W6
44	Sharkey's Shootout	JUL/OCT 00 780-5072-01	8MB	8MB	8MB	Not Used	W6
45	High Roller Casino	JAN 01 780-5065-00	8MB	8MB	8MB	8MB	W6
46	Austin Powers™	MAY 01 780-5074-00	8MB	8MB	8MB	8MB	W6
47	MONOPOLY®	SEP 01 780-5075-00	8MB	8MB	8MB	Not Used	W6
48	Playboy	FEB 02 780-5076-00	8MB	8MB	8MB	8MB	W6
49	RollerCoaster Tycoon™	AUG 02 780-5078-00	8MB	8MB	8MB	Not Used	W6
50	The Simpsons™ Pinball Party	JAN 03 780-5077-00	8MB	8MB	8MB	8MB	W6
51	T3®: Rise of the Machines™	MAY 03 780-5079-00	8MB	8MB	8MB	8MB	W6
52	The Lord of the Rings™	NOV 03 780-5080-00	8MB	8MB	8MB	8MB	
53	Ripley's Believe It or Not!®	APR 04 780-5081-00	8MB	8MB	8MB	8MB	

‡ Additional Information for Installed Jumper (above games 41-51):

• Installed **W6** so 8MB ROMS can be utilized. See the **CPU/Sound Board Schematic** (Sheet 2 of 3, Address Location 3E) in the games' Service Game Manual. Games 52 - 57 CPU/Sound Board differ than <51 (See Appendix D).

See **Apdx. A** for more detailed information on **Pinball Game Firmware** (ROM Name, Size, Part Numbers, USA Version & Checksum and Board Locations).

Game Name White Star Board System™	Production Start Date and Manual Part Nr.	CPU/Sound Board Sound U7 512K CPU/Sound Board Game U210 1MB CPU/Sound Board Voice ROMS:				
		U17	U21	U36	U37	
54	Elvis®	AUG 04 780-5084-00	8MB	8MB	8MB	8MB
55	The Sopranos™	FEB 05 780-5085-00	8MB	8MB	8MB	8MB
56	NASCAR®	JUL 05 780-5086-00	8MB	8MB	8MB	8MB
57	Grand Prix	SEP 05 780-5091-00	8MB	8MB	8MB	8MB

See **Apdx. A** for more detailed information on **Pinball Game Firmware** (ROM Name, Size, Part Numbers, USA Version & Checksum and Board Locations).

Game Name S.A.M. System	Production Start Date and Manual Part Nr.	S.A.M. System CPU/Sound Board Boot EPROM U9			
		965-BOOT-SAM (Programmed)			
58	World Poker Tour™ (WPT)	JUN 06 780-5088-00	8MB	B-02 V2.1+ chksum \$F625	LOC: U9
59	The Simpsons™ Kooky Carnival	APR 06 780-5090-00	8MB	B-02 V2.1+ chksum \$F625	LOC: U9
60	©Disney's Pirates of the Caribbean	AUG 06 780-5092-00	8MB	B-02 V2.1+ chksum \$F625	LOC: U9
61	Famil Guy™	DEC 06 780-5093-00	8MB	B-02 V2.1+ chksum \$F625	LOC: U9
62	Spider-Man™	MAY 07 780-5094-00	8MB	B-02 V2.1+ chksum \$F625	LOC: U9

Games 58 – current, S.A.M. System : CPU/Sound & I/O Power Driver PCBs differ than White Star (previous Games 29 – 57); Disp. Controller Not Required.





APPENDIX D

Board Type (White Star Board System* Only) Table



Game Name	Flipper	I/O Power Driver	CPU/Sound Stereo	Disp. Power Supply	Dot Matrix Display	Display Controller	OPTO Transmitter	OPTO Receiver	OPTO Application
Apollo 13	520-5080-00 2-Flipper	520-5137-00	520-5136-00	520-5138-00	520-5052-00 128 X 32 Dots	520-5055-01	520-5124-00 Single OPTO	520-5125-00 Single OPTO	5-Ball Trough over Up-Kicker
	Miscellaneous PC Boards:	Light Boards 520-5130-01, -04 & -05 Magnet Interface, 7-Segment Display & Light Bd. 520-5130-06 Magnet Driver Board 520-5130-02 Switch Membrane Board 520-5130-03				Relay Board 520-5010-00			
Golden Eye	520-5080-00 2-Flipper	520-5137-00	520-5136-00	520-5138-00	520-5052-00 128 X 32 Dots	520-5055-01	520-5124-00 Single OPTO	520-5125-00 Single OPTO	5-Ball Trough over Up-Kicker
	Miscellaneous PC Boards:	Light Boards 520-5128-05 through -08		Mag. Processor X2 Driver Bd. 520-5143-00	Relay Board 520-5010-00				
GAMES HEREON NO LONGER REQUIRE THE FLIPPER BOARD WITH THE WHITE STAR BOARD SYSTEM™									
Game Name	I/O Power Driver	CPU/Sound Mono	Disp. Power Supply	Dot Matrix Display	Display Controller	OPTO Transmitter	OPTO Receiver	OPTO Application	Misc OPTO & App.
Twister	520-5137-01	520-5136-10	520-5138-00	520-5052-00 128 X 32 Dots	520-5055-01	520-5124-00 Single OPTO	520-5125-00 Single OPTO	5-Ball Trough over Up-Kicker	
	Miscellaneous PC Boards:	Light Boards 520-5145-01 through -07		Mag. Drv. Bd. 520-5143-00	Relay Board 520-5010-00				
Independence Day (ID4)	520-5137-01	520-5136-10	520-5138-00	520-5052-00 128 X 32 Dots	520-5055-01	520-5124-00 Single OPTO	520-5125-00 Single OPTO	4-Ball Trough over Up-Kicker	
	Miscellaneous PC Boards:	Light Boards 520-5149-01 through -10		Servo Mtr. Bd. 520-5152-00		520-5082-00 Long Hop OPTO	520-5083-00 Long Hop OPTO	Alien Head Enter	
Space Jam	520-5137-01	520-5136-10	520-5138-00	520-5052-00 128 X 32 Dots	520-5055-01	520-5124-00 Single OPTO	520-5125-00 Single OPTO	5-Ball Trough over Up-Kicker	
	Miscellaneous PC Boards:	2X 7-Segment Display Board 520-5153-00							
The Star Wars Trilogy - Special Ed.	520-5137-01	520-5136-10	520-5138-00	520-5052-00 128 X 32 Dots	520-5055-01	520-5124-00 Single OPTO	520-5125-00 Single OPTO	4-Ball Trough over Up-Kicker	
	Miscellaneous PC Boards:	Relay Board 520-5010-00							
The Lost World: J.P.	520-5137-01	520-5136-10	520-5138-00	520-5052-00 128 X 32 Dots	520-5055-01	520-5124-00 Single OPTO	520-5125-00 Single OPTO	4-Ball Trough over Up-Kicker	520-5162-00 2-Pos. Motor Sensor on Snagger Motor
	Miscellaneous PC Boards:	DC Relay Bd. 520-5066-00	Shaker Mtr. Bd. 520-5065-00						
The X-Files	520-5137-01	520-5136-10	520-5138-00	520-5052-00 128 X 32 Dots	520-5055-01	520-5124-00 Single OPTO	520-5125-00 Single OPTO	4-Ball Trough over Up-Kicker	520-5155-00 3-Pos. Motor Sensor on File Cab. Motor
	Miscellaneous PC Boards:					520-5082-00 Long Hop OPTO	520-5083-00 Long Hop OPTO	File Cabinet Enter	
Starship Troopers	520-5137-01	520-5136-15	520-5138-00	520-5052-00 128 X 32 Dots	520-5055-02	520-5124-00 Single OPTO	520-5125-00 Single OPTO	4-Ball Trough over Up-Kicker	
	Miscellaneous PC Boards:	4X 7-Segment Display Board 520-5166-00					520-5082-00 Long Hop OPTO	520-5083-01 Long Hop OPTO	L/R Orbit Lane Enter
Viper Night Drivin'	520-5137-01	520-5136-16	520-5138-00	520-5052-00 128 X 32 Dots	520-5055-03	520-5124-00 Single OPTO	520-5125-00 Single OPTO	4-Ball Trough over Up-Kicker	
	Miscellaneous PC Boards:	Relay Board 520-5010-00				520-5082-00 Long Hop OPTO	520-5083-01 Long Hop OPTO	Jump Ramp	
Lost In Space	520-5137-01	520-5136-16	520-5138-00	520-5052-00 128 X 32 Dots	520-5055-03	515-0173-00 Dual OPTO	515-0174-00 Dual OPTO	4-Ball Trough over Up-Kicker	
	Miscellaneous PC Boards:	Relay Board 520-5010-00							
Godzilla	520-5137-01	520-5136-16	520-5138-00	520-5052-00 128 X 32 Dots	520-5055-03	515-0173-00 Dual OPTO	515-0174-00 Dual OPTO	4-Ball Trough over Up-Kicker	
	Miscellaneous PC Boards:	Shaker Mtr. Bd. 520-5065-00							
South Park	520-5137-01	520-5136-16	520-5138-00	520-5052-00 128 X 32 Dots	520-5055-03	515-0173-00 Dual OPTO	515-0174-00 Dual OPTO	5-Ball Trough over Up-Kicker	
	Miscellaneous PC Boards:					520-5082-00 Long Hop OPTO	520-5083-01 Long Hop OPTO	Kenny Under Trough Enter	
Harley-Davidson® 1st-3rd* Editions	520-5137-01	520-5136-16 *520-5300-00*	520-5138-00	520-5052-00 128 X 32 Dots	520-5055-03	515-0173-00 Dual OPTO	515-0174-00 Dual OPTO	4-Ball Trough over Up-Kicker	
	Miscellaneous PC Boards:	Relay Board 520-5010-00		Shaker Mtr. Bd. 520-5065-00	Diode Board 520-5146-00	520-5082-00 Long Hop OPTO	520-5083-01 Long Hop OPTO	Motorcycle Enter	
Striker Xtreme (NFL)	520-5137-01	520-5136-16	520-5138-00	520-5052-00 128 X 32 Dots	520-5055-03	515-0173-00 Dual OPTO	515-0174-00 Dual OPTO	4-Ball Trough over Up-Kicker	520-5155-00 3-Pos. Motor Sensor on Goalie Motor
	Miscellaneous PC Boards:	DC Relay Bd. 520-5066-00	Relay Board 520-5010-00	Diode Board 520-5146-00	for UK ONLY- Solenoid Expander Bd. 520-5192-00	520-5082-00 Long Hop OPTO	520-5083-01 Long Hop OPTO	Goalie Under- Trough Enter	
Sharkey's Shootout	520-5137-64	520-5136-64	520-5138-00	520-5052-00 128 X 32 Dots	520-5055-03	515-0173-00 Dual OPTO	515-0174-00 Dual OPTO	4-Ball Trough over Up-Kicker	520-5194-00 4-Pos. Motor Sensor on ? -Ball Motor
	Miscellaneous PC Boards:	Relay Board 520-5010-00		Sol. Exp. Bd. 520-5192-00					
High Roller Casino	520-5137-01	520-5136-16	520-5138-00	520-5052-00 128 X 32 Dots	520-5055-03	515-0173-00 Dual OPTO	515-0174-00 Dual OPTO	4-Ball Trough over Up-Kicker	520-5194-00 4-Pos. Motor Sensor on Roulette Wheel Motor
	Miscellaneous PC Boards:	Dot Display (5X7) in Slot Mach. 520-5197-00				for UK ONLY- Solenoid Expander Bd. 520-5192-00	520-5196-00 3-Pos. OPTO	520-5195-00 3-Pos. OPTO	Ball Lock under Roulette Up/Dn Ramp in Slot Mach.
Austin Powers™	520-5137-01	520-5136-16	520-5138-00	520-5052-00 128 X 32 Dots	520-5055-03	515-0173-00 Dual OPTO	515-0174-00 Dual OPTO	4-Ball Trough over Up-Kicker	520-5212-00 Pulse-Stretcher OPTO on Spini-Me
	Miscellaneous PC Boards:	Relay Bd. (X3) 520-5010-00			for UK ONLY- Solenoid Expander Bd. 520-5192-00	520-5082-00 Long Hop OPTO	520-5083-01 Long Hop OPTO	Time Machine Ramp	
MONOPOLY®	520-5137-01	520-5136-16	520-5138-00	520-5052-00 128 X 32 Dots	520-5055-03	515-0173-00 Dual OPTO	515-0174-00 Dual OPTO	4-Ball Trough over Up-Kicker	
	Miscellaneous PC Boards:	DC Relay Bd. 520-5066-00	Mini-Dot Display (3 by 5X7) 520-5197-00 (Electric C- Sign)		for UK ONLY- Solenoid Expander Bd. 520-5192-00	520-5218-00 4-Pos. OPTO	520-5210-00 4-Pos. OPTO	Bank Door	

Table continued on the next page.





APPENDIX D

Board Type (White Star Board System* & S.A.M. System** Only) Table



Game Name	I/O Power Driver	CPU/Sound (old & new)	Disp. Power Supply	Dot Matrix Display	Display Controller	OPTO Transmitter	OPTO Receiver	OPTO Application	Misc OPTO & App.
Playboy	520-5137-01	520-5136-16	520-5138-00	520-5052-00 128 X 32 Dots	520-5055-03	515-0173-00 Dual OPTO	515-0174-00 Dual OPTO	4-Ball Trough over Up-Kicker	
	Miscellaneous PC Boards:	DC Relay Bd. 520-5066-00	Relay Bd. 520-5010-00		for UK ONLY- Solenoid Expander Bd. 520-5192-00				
RollerCoaster Tycoon™	520-5137-01	520-5136-16	520-5138-00	520-5052-00 128 X 32 Dots	520-5055-03	515-0173-00 Dual OPTO	515-0174-00 Dual OPTO	4-Ball Trough over Up-Kicker	520-5222-00 1-Position Switch Detect on Wheel Spin
	Miscellaneous PC Boards:	DC Relay Bd. 520-5066-00	Mini-Dot Display (3 by 5X7) 520-5221-00 (Ramp Enter Sign)		for UK ONLY- Solenoid Expander Bd. 520-5192-00	520-5082-00 Long Hop OPTO	520-5083-01 Long Hop OPTO	Behind 1-Bank Drop Target	
The Simpsons™ Pinball Party	520-5137-01	520-5136-16	520-5138-00	520-5052-00 128 X 32 Dots	520-5055-03	515-0173-00 Dual OPTO	515-0174-00 Dual OPTO	4-Ball Trough over Up-Kicker	
	Miscellaneous PC Boards:	LED Bd. 520-5219-00	Color Dot Display (4 by 5X7) 520-5225-00 (TV Set)		for UK ONLY ◀◀◀ Aux. Driver Bd. 520-5068-01				
Terminator® 3: Rise of the Machines™	520-5137-01	520-5136-16	520-5138-00	520-5052-00 128 X 32 Dots	520-5055-03	515-0173-00 Dual OPTO	515-0174-00 Dual OPTO	4-Ball Trough over Up-Kicker	
	Miscellaneous PC Boards:				for UK ONLY ◀◀◀ Aux. Driver Bd. 520-5068-01	515-7307-00 Single OPTO	515-7308-00 Single OPTO	TXCannon Trough	
The Lord of the Rings™	520-5137-01	New 520-5300-00	520-5138-00	520-5052-00 128 X 32 Dots	520-5055-03	515-0173-00 Dual OPTO	515-0174-00 Dual OPTO	4-Ball Trough over Up-Kicker	500-6746-00 (White Trans.) 500-6747-00 (Black Rec.)
	Miscellaneous PC Boards:	19-LED PCB 520-5242-00	OPTO Transmitter / Receiver Amplifier PCB 520-5239-00		for UK ONLY ◀◀◀ Aux. Driver Bd. 520-5068-01	515-7307-00 Single OPTO	515-7308-00 Single OPTO	Orthanc Tower Trough	
Ripley's Believe It or Not!®	520-5137-01	520-5300-00	520-5138-00	520-5052-00 128 X 32 Dots	520-5055-03	515-0173-00 Dual OPTO	515-0174-00 Dual OPTO	4-Ball Trough over Up-Kicker	500-6775-00 OPTO Trnscvr
	Miscellaneous PC Boards:	520-5236-00 X3 Dot Display	OPTO Transmitter / Receiver Amplifier PCB 520-5239-01		for UK ONLY ◀◀◀ Aux. Driver Bd. 520-5068-01	520-5234-00 3-Pos. OPTO	520-5234-00 3-Pos. OPTO	Vari-Target	520-5235-03 X3 Aux. Drvr
Elvis®	520-5137-01	520-5300-00	520-5138-00	520-5052-00 128 X 32 Dots	520-5055-03	515-0173-00 Dual OPTO	515-0174-00 Dual OPTO	4-Ball Trough over Up-Kicker	
	Miscellaneous PC Boards:				for UK ONLY ◀◀◀ Aux. Driver Bd. 520-5068-01				
The Sopranos™	520-5137-01	520-5300-00	520-5138-00	520-5052-00 128 X 32 Dots	520-5055-03	515-0173-00 Dual OPTO	515-0174-00 Dual OPTO	4-Ball Trough over Up-Kicker	
	Miscellaneous PC Boards:				for UK ONLY ◀◀◀ Aux. Driver Bd. 520-5068-01				
NASCAR® and [NDSE]	520-5137-01	520-5300-00	520-5138-00	520-5052-00 128 X 32 Dots	520-5055-03	515-0173-00 Dual OPTO	515-0174-00 Dual OPTO	4-Ball Trough over Up-Kicker	500-6775-00 OPTO Trans. (Qty. 16) Switch Detect.
	Miscellaneous PC Boards:	520-5235-03 X3 Aux. Drvr	OPTO Transmitter / Receiver Amplifier PCB 520-5239-01		for UK ONLY ◀◀◀ Aux. Driver Bd. 520-5068-01				
Grand Prix	520-5137-01	520-5300-00	520-5138-00	520-5052-00 128 X 32 Dots	520-5055-03	515-0173-00 Dual OPTO	515-0174-00 Dual OPTO	4-Ball Trough over Up-Kicker	500-6775-00 OPTO Trans. (Qty. 16) Switch Detect.
	Miscellaneous PC Boards:	520-5235-03 X3 Aux. Drvr	OPTO Transmitter / Receiver Amplifier PCB 520-5239-01		for UK ONLY ◀◀◀ Aux. Driver Bd. 520-5068-01				

Game Name	I/O Power Driver**	CPU / Sound**	Disp. Power Supply	Dot Matrix Display	Dual OPTO Transmitter	Dual OPTO Receiver	Dual OPTO Transceiver	OPTO Transceiver Miscellaneous
World Poker Tour™ (WPT)	520-5249-00 Backbox	520-5246-00 Backbox	520-5138-00 Backbox	520-5052-00 128 X 32 Dots	515-0173-00 4-Ball Trough	515-0174-00 4-Ball Trough	500-6775-00 4 Switch Pairs (Qty. 8)	520-5251-00 'U' 1/per PCB Jail Bars Up Ace/Hole Mech 520-5252-04 'U' 4/per PCB Drop Targets 4- & 8- Banks
	Miscellaneous PCBs:	520-5254-00 50V Step-Up Drv	520-5250-14 14LED 5X7 Disp.	520-5239-01 OPTO Amplifier	520-5247-00 Ace/Hole Mech	520-5248-00 Ace/Hole Mech		
The Simpsons™ Kooky Carnival	520-5249-00 Back Door	520-5246-00 Back Door	520-5138-00 Cabinet Rear	520-5052-00 128 X 32 Dots			520-5253-00-ASY Coin Drop (Qty. 11)	
	Miscellaneous PCBs:	515-5742-00 Shaker PCB	500-6700-00 Relay (incl. Wiring + Conn.)					
©Disney's Pirates of the Caribbean	520-5249-00 Backbox	520-5246-00 Backbox	520-5138-00 Backbox	520-5052-00 128 X 32 Dots	515-0173-00 4-Ball Trough	515-0174-00 4-Ball Trough	500-6775-00 5 Switch Pairs (Qty. 10)	
	Miscellaneous PCBs:	520-5239-01 OPTO Amp. (X3)	511-5024-03 Relay (incl. Wiring + Conn.)	520-5238-00 : H-E-A-R-T LED PCB				
Family Guy™	520-5249-00 Backbox	520-5246-00 Backbox	520-5138-00 Backbox	520-5052-00 128 X 32 Dots	515-0173-00 4-Ball Trough	515-0174-00 4-Ball Trough	500-6775-00 3 Switch Pairs (Qty. 6)	520-5252-01 'U' 1/per PCB Drop Target 1-Bank
	Miscellaneous PCBs:	520-5239-01 OPTO Amp. (X2)	520-5261-00 Stepper Motor	511-5042-01 Trgt. Sensor (X2)			500-6775-01 1 Switch Pair (Qty. 2)	520-5252-04 'U' 4/per PCB Drop Target 4-Bank
Spider-Man™	520-5249-00 Backbox	520-5246-00 Backbox	520-5138-00 Backbox	520-5052-00 128 X 32 Dots	515-0173-00 4-Ball Trough	515-0174-00 4-Ball Trough	500-6775-00 3 Switch Pairs (Qty. 6)	
	Miscellaneous PCBs:	520-5239-01 OPTO Amp. (X2)						



APPENDIX D

Board Type Table

Game Name	Flipper	Sound	Power Supply	Display X-Digit
<ul style="list-style-type: none"> Laser War 	2-Flipper Board Not Required	<i>initial:</i> 520-5002-00 <i>replaced with:</i> 520-5002-02 <i>520-5002-01 was not used.</i>	520-5000-00	Master: 520-5004-00 plus: 520-5005-00 (Qty. 2); 7 Digit Alpha/Numeric 520-5006-00 (Qty. 2); 7 Digit Numeric 520-5007-00 (Qty. 1); 4 Digit Numeric
<ul style="list-style-type: none"> Secret Service Torpedo Alley 	3-Flipper Board Not Required	520-5002-02		520-5014-01 7 Digit Alpha/Numeric Combined
<ul style="list-style-type: none"> Time Machine 	2-Flipper Board Not Required			520-5030-00 16 Digit Alpha/Numeric Combined
<ul style="list-style-type: none"> Playboy 35th Anniversary * ABC Monday Night Football * Robocop Phantom of the Opera Back to the Future The Simpsons 	520-5033-00 2-Flipper <i>(*only for 100 games of Playboy 35th Anniv. & ABC Mon. Night Football)</i>			
		520-5002-03		

Game Name	Flipper	Sound	Power Supply	Dot Matrix Display	Display Controller	OPTO Transmitter	OPTO Receiver	OPTO Application
<ul style="list-style-type: none"> Checkpoint Teenage Mutant Ninja Turtles 	520-5033-00 2-Flipper	520-5002-03	520-5047-00	520-5042-00 128 X 16	520-5055-00			
<ul style="list-style-type: none"> Batman Star Trek 25th Anniv. Hook 		520-5050-01						
<ul style="list-style-type: none"> Lethal Weapon 3 		520-5050-02	520-5047-01					
<ul style="list-style-type: none"> Star Wars Rocky & Bullwinkle & Friends 			520-5052-00 128 X 32					
<ul style="list-style-type: none"> Jurassic Park 		520-5076-00 3-Flipper		520-5047-02				
<ul style="list-style-type: none"> Last Action Hero 		520-5070-00 2-Flipper						
<ul style="list-style-type: none"> Tales from the Crypt 		520-5076-00 3-Flipper	520-5077-00					
<ul style="list-style-type: none"> The Who's Tommy 		520-5070 / 5080 -00 4-Flipper (2X2)						
<ul style="list-style-type: none"> WWF Royal Rumble 		520-5076-00 3-Flipper	520-5050-03					
<ul style="list-style-type: none"> Guns N' Roses 		520-5076-00 3-Flipper						
<ul style="list-style-type: none"> Maverick 	520-5076-00 3-Flipper	520-5077-00	520-5047-03	520-5075-00 192 X 64	520-5092-01	520-5102-00 Single OPTO	520-5103-00 Single OPTO	Paddle Boat Wheel Enter
<ul style="list-style-type: none"> Mary Shelley's Frankenstein 	520-5076-00 3-Flipper	520-5126-02				520-5124-00 Single OPTO	520-5125-00 Single OPTO	5-Ball Trough over Up-Kicker
<ul style="list-style-type: none"> Baywatch 	520-5070 / 5080 -00 4-Flipper (2X2)					520-5124-00 Single OPTO	520-5125-00 Single OPTO	4-Ball Trough over Up-Kicker
<ul style="list-style-type: none"> Batman Forever 	520-5076-00 3-Flipper							

Miscellaneous Boards (Lamp Boards & Relay Boards) not listed above can be found in each individual game manual.





APPENDIX E

Flipper Coil (White Star Board System* & S.A.M. System** Only) Table



Typical Coil Diode 1N4004 unless noted otherwise (Diode Top = above lugs next to windings; Diode Below (Bottom) = under lugs opposite of windings).

STANDARD COILS (TYPICAL APPLICATIONS)			LARGE COILS (FLIPPERS & SPECIAL APPLICATIONS)		
Ga.-Turn	Res (Ω)	SPI Part Number and Comments	Ga.-Turn	Res (Ω)	SPI Part Number and Comments
20-400	1.0 Ω	090-5021-use: -00 Diode Top	21-900	call Ω	090-5020-use: -01 3-Lugs + 1N4004 & 1N5404 Diodes -10 Diode Top <BROWN><RED>
22-500	1.7 Ω	090-5017-use: -00 Diode Top	22-750 / 30-2600	2.6 Ω 92.0 Ω	090-5011-use: -00 DUAL WND COIL // 3-Lugs Diode x2
22-600	2.2 Ω	090-5017-use: -0B Diode Below // -0T Diode Top			
23-700	3.1 Ω	090-5022-use: -0B Diode Below // -0T Diode Top	22-900	3.45 Ω	090-5020-use: -20T Diode Top <YELLOW> // -20-ND No Diode
23-750	3.4 Ω	090-5019-use: -00 Diode Top			
23-800	3.6 Ω	090-5001-use: -0B Diode Below // -0T Diode Top // -NL No Lugs 11" Leads // -ND No Diode	22-1080	4.2 Ω	090-5032-use: -0B D. Below // -0T D. Top <YEL-GRN> -NL No Diode
23-840	4.0 Ω	090-5005-use: -00 Diode Top			
23.5-765	3.6 Ω	090-5037-use: -03 Diode Top	23-620 / 30-2600	2.4 Ω 75.0 Ω	090-5006-use: -00 DUAL WND COIL // 3-Lugs Diode x2
24-900	5.0 Ω	090-5002-use: -02 Diode Top // -10 No Lugs 14" Leads			
24-940	5.5 Ω	090-5036-use: -0B Diode Below // -0T Diode Top use 090-5051-01 No Lugs 11" Leads	23-700 / 30-2600	3.0 Ω 83.5 Ω	090-5013-use: -00 DUAL WOUND COIL // Diode Top
25-1240	9.3 Ω	090-5034-use: -00 Diode Below			
26-1200	10.3 Ω	090-5044-use: -0B Diode Below // -0T Diode Top // -NL No Lugs 11" Leads // -ND No Diode	23-800 / 30-2600	2.4 Ω 90.5 Ω	090-5012-use: -00 DUAL WOUND COIL // Diode Top
27-1300	14.2 Ω	090-5003-use: -0T Diode Top			
27-1400	14.7 Ω	090-5015-use: -00 Diode Below	23-1100	5.1 Ω	090-5030-use: -0T Diode Top <ORANGE> -ND No Diode
27-1400	14.7 Ω	511-5031-00 Special App.: No Diode / Lugs + Conn.			
27-1500	16.3 Ω	090-5004-use: -0B Diode Below // -0T Diode Top	23-1200	7.1 Ω	090-5008-use: -00 Diode Top <BLACK>
29-2000	33.6 Ω	090-5016-use: -00 Diode Top	23-1500	4.4 Ω	090-5062-use: -00 Diode Top <BLUE>
LARGE, MEDIUM & MINI COILS (MAGNET APPLICATIONS)			24-1570	9.5 Ω	090-5025-use: -00 Diode Top <BLUE>
20.5-480	2.9 Ω	090-5064-use: -02 No Lugs or Core; 14" Leads // Large	25-1400	call Ω	090-5067-use: -0T Diode Top <RED>
22-650	4.3 Ω	090-5042-use: -00 No Lugs or Core; 6" Leads // Large -01 No Lugs or Core; 12" Leads // Large	25-1600	call Ω	090-5068-use: -0T Diode Top <WHITE>
24-780	8.0 Ω	090-5061-use: -00 No Lugs or Core; 6" Lds. // Medium	MINI COILS (RESET / TRIP APPLICATIONS)		
29-1000	15.2 Ω	090-5059-use: -00 Lugs + Diode + Magnet Core // Mini	27-950	call Ω	090-5046-use: -01 Diode Top
31-1500	52.0 Ω	090-5054-00: Straight Lugs + Diode + Mag Core // Mini 090-5055-00: 90° Lugs + Diode + Magnet Core // Mini	28-1050	11.5 Ω	090-5046-use: -00 Diode Top
Please Note: Ohm values may vary +/- .03 depending on meter calibration.			27-880	call Ω	500-6976-01 No Lugs or Diode + 6" Leads & Conn.
Ordering Note: Coils typically should not come with Coil Sleeves. IF A SLEEVE EXISTS, ensure it is the correct sleeve for the application usage. For the correct Coil Sleeve, refer to the Game Assembly Drawing the coil exists on and order separately.			31-590	call Ω	090-5010-use: -00 Diode Top
			32-1250	35.0 Ω	515-6916-01: includes Flap & Screw <YELLOW>
			32-1800	50.2 Ω	090-5031-use: -0B Diode Below // -0T Diode Top (515-6110-00) use 515-# to include mounting & armature brackets
			33-1590	59.0 Ω	515-6916-00: includes brackets <WHITE>

Flipper Coil (White Star Board System* Only) Table

GAME NAME	Nº of Flippers	FLIPPERS		FLIPPERS no E.O.S. Switch	
		SPI Nº / GAUGE-TURNS / Color		SPI Nº / GAUGE-TURNS / Color	
		LOWER LEFT	LOWER RIGHT	UPPER LEFT	UPPER RIGHT
Apollo 13	2	090-5032-0T 22-1080 -YEL-GRN-	SAME	Not Used	Not Used
Golden Eye	2	090-5032-0T 22-1080 -YEL-GRN-	SAME	Not Used	Not Used
Twister	2	090-5020-20T 22-900 -YELLOW-	090-5032-0T 22-1080 -YEL-GRN-	Not Used	Not Used
ID4: Independence Day	3	090-5032-0T 22-1080 -YEL-GRN-	SAME	Not Used	090-5020-30 23-900 -GREEN-
Space Jam †	2	090-5032-0T 22-1080 -YEL-GRN-	090-5020-20T 22-900 -YELLOW-	Not Used	Not Used
The Star Wars Trilogy - Special Edition †	2	090-5032-0T 22-1080 -YEL-GRN-	SAME	Not Used	Not Used
The Lost World: Jurassic Park †	2	090-5032-0T 22-1080 -YEL-GRN-	SAME	Not Used	Not Used
The X-Files †	2	090-5032-0T 22-1080 -YEL-GRN-	SAME	Not Used	Not Used
Starship Troopers †	3	090-5030-0T 23-1100 -ORANGE-	SAME	Not Used	090-5032-0T 22-1080 -YEL-GRN-
Viper Night Drivin' †	2	090-5030-0T 23-1100 -ORANGE-	SAME	Not Used	Not Used
Lost In Space †	2	090-5030-0T 23-1100 -ORANGE-	090-5032-0T 22-1080 -YEL-GRN-	Not Used	Not Used
Godzilla †	2	090-5032-0T 22-1080 -YEL-GRN-	SAME	Not Used	Not Used
South Park †	2	090-5030-0T 23-1100 -ORANGE-	SAME	Not Used	Not Used

† Coil Part Numbers ending with a "T" signifies the Diode is on the top of the lug (on the coil-winding side); Coil Part Numbers ending with a "B" signifies the Diode is on the bottom of the lugs.

Table continued on the next page.





APPENDIX E

Flipper Coil (White Star Board System* & S.A.M. System** Only) Table



GAME NAME	N ^o of Flippers	FLIPPERS w/E.O.S. Switch		FLIPPERS no E.O.S. Switch	
		SPI N ^o / GAUGE-TURNS / Color		SPI N ^o / GAUGE-TURNS / Color	
		LOWER LEFT	LOWER RIGHT	UPPER LEFT	UPPER RIGHT
Harley-Davidson® † and 1st through 3rd Editions	2	090-5032-0T 22-1080 -YEL-GRN-	090-5030-0T 23-1100 -ORANGE-	Not Used	Not Used
Striker Xtreme (NFL) †	3	090-5032-0T 22-1080 -YEL-GRN-	090-5030-0T 23-1100 -ORANGE-	090-5030-0T 23-1100 -ORANGE-	Not Used
Sharkey's Shootout †	3	090-5030-0T 23-1100 -ORANGE-	SAME	090-5030-0T 23-1100 -ORANGE-	Not Used
High Roller Casino †	2	090-5032-20T 22-900 -YELLOW-	090-5032-0T 22-1080 -YEL-GRN-	Not Used	Not Used
Austin Powers™ †	2	090-5020-30 23-900 -GREEN-	090-5030-0T 23-1100 -ORANGE-	Not Used	Not Used
MONOPOLY® †	3	090-5032-0T 22-1080 -YEL-GRN-	SAME	Not Used	090-5062-0T 23-1500 -BLUE-
Playboy †	2	090-5030-0T 23-1100 -ORANGE-	SAME	Not Used	Not Used
RollerCoaster Tycoon™ †	4	090-5032-0T 22-1080 -YEL-GRN-	SAME	090-5067-0T 25-1400 -RED-	090-5068-0T 25-1600 -WHITE-
The Simpsons™ Pinball Party †	6** (5 with Flipper Bats)	090-5032-0T 22-1080 -YEL-GRN-	SAME	Not Used	090-5030-0T 23-1100 -ORANGE-
		** The Homer Head Assembly is affixed to an Upr. Rt. Style Flipper (no E.O.S. Switch):		Flippers (Mini-Bats) on 2nd Level Playfield:	
			** 090-5020-20T 22-900 -YELLOW-	090-5041-00T 25-1800 -BLU-GRN-	090-5025-00 24-1570 -BLUE-
Terminator® 3: Rise of the Machines™ †	2	090-5032-0T 22-1080 -YEL-GRN-	SAME	Not Used	Not Used
The Lord of the Rings™ †	2	090-5020-20T 22-900 -YELLOW-	SAME	Not Used	Not Used
Ripley's Believe It or Not!® †	3	090-5032-0T 22-1080 -YEL-GRN-	SAME	Not Used	090-5067-00T 25-1400 -RED-
Elvis® †	4	090-5020-20T 22-900 -YELLOW-	SAME	090-5020-30 23-900 -GREEN-	SAME
The Sopranos™ †	2	090-5032-0T 22-1080 -YEL-GRN-	SAME	Not Used	Not Used
NASCAR® and [NDSE] †	2	090-5030-0T 23-1100 -ORANGE-	SAME	Not Used	Not Used
Grand Prix †	2	090-5030-0T 23-1100 -ORANGE-	SAME	Not Used	Not Used
† Coil Part Numbers ending with a "T" signifies the Diode is on the top of the lug (on the coil-winding side); Coil Part Numbers ending with a "B" signifies the Diode is on the bottom of the lugs.					
** S.A.M. System Games DO NOT REQUIRE DIODES. If you use a coil from your stock which has a diode, remove it ONLY FOR S.A.M. System Games.					
World Poker Tour™ (WPT)**	4	090-5032-ND 22-1080 [NO DIODE]	SAME	090-5030-ND 23-1100 [NO DIODE]	SAME
©Disney's Pirates of the Caribbean**	2	090-5030-ND 23-1100 [NO DIODE]	SAME	Not Used	Not Used
Family Guy™ **	3 Norm.	090-5030-ND 23-1100 [NO DIODE]	SAME	090-5062-ND 23-1500 [NO DIODE]	Not Used
	2 Mini	090-5046-01-ND 27-950 [NO DIODE]	SAME		
Spider-Man™ **	3	090-5032-ND 22-1080 [NO DIODE]	SAME	Not Used	090-5032-ND 22-1080 [NO DIODE]



APPENDIX E

Generic Coil Cross-Reference Guide † ‡

Flipper Coil Table ‡ ††

GAME NAME	Nº of Flippers	FLIPPERS w/E.O.S. Switch		FLIPPERS no E.O.S. Switch	
		SPI Nº / GAUGE-TURNS / Color		SPI Nº / GAUGE-TURNS / Color	
		LOWER LEFT	LOWER RIGHT	UPPER LEFT	UPPER RIGHT
Laser War ‡	2	090-5011-00 22-750 / 30-2600	SAME	Not Used	Not Used
Secret Service ‡	3	090-5006-00 23-620 / 30-2600	SAME	Not Used	090-5006-00 23-620 / 30-2600
Torpedo Alley ‡	3	090-5011-00 22-750 / 30-2600	090-5013-00 23-700 / 30-2600	Not Used	090-5012-00 23-800 / 30-2600
Time Machine ‡	2	090-5011-00 22-750 / 30-2600	SAME	Not Used	Not Used
‡ These coils are dual-wound.					
Playboy 35th Anniversary ††	2	090-5020-02 22-900 -YEL-YEL-	SAME	Not Used	Not Used
ABC Monday Night Football ††	2	090-5020-02 22-900 -YEL-YEL-	SAME	Not Used	Not Used
†† A very small % of these games used a 090-5020-20 coil which used a proto-type Solid State Flipper System. The two types of coils both are 22-900 coils; the only difference is the addition of the 1N5404 Diode on the (-02) coils which was used in the Deger Design.					
Robocop	2	090-5020-20 22-900 -YEL-YEL-	SAME	Not Used	Not Used
Phantom of the Opera	2	090-5020-20 22-900 -YEL-YEL-	SAME	Not Used	Not Used
Back to the Future	2	090-5020-20 22-900 -YEL-YEL-	SAME	Not Used	Not Used
The Simpsons	2	090-5020-20 22-900 -YEL-YEL-	SAME	Not Used	Not Used
Checkpoint	2	090-5020-20 22-900 -YEL-YEL-	SAME	Not Used	Not Used
Teenage Mutant Ninja Turtles	2	090-5020-30 23-900 -GRN-GRN-	SAME	Not Used	Not Used
Batman	2	090-5020-30 23-900 -GRN-GRN-	SAME	Not Used	Not Used
Star Trek 25th Anniversary	2	090-5020-30 23-900 -GRN-GRN-	SAME	Not Used	Not Used
Hook	2	090-5030-00 23-1100 -ORG-ORG-	090-5020-30 23-900 -GRN-GRN-	Not Used	Not Used
Lethal Weapon 3	2	090-5030-00 23-1100 -ORG-ORG-	SAME	Not Used	Not Used
Star Wars	2	090-5032-00 22-1080 -YEL-GRN-	SAME	Not Used	Not Used
Rocky & Bullwinkle & Friends	2	090-5020-30 23-900 -GRN-GRN-	SAME	Not Used	Not Used
Jurassic Park	3	090-5020-30 23-900 -GRN-GRN-	SAME	Not Used	090-5030-00 23-1100 -ORG-ORG-

Table continued on the next page.



APPENDIX E

Flipper Coil Table †

GAME NAME	N ^o of Flippers	FLIPPERS w/ E.O.S. Switch		FLIPPERS no E.O.S. Switch	
		SPI N ^o / GAUGE-TURNS / Color		SPI N ^o / GAUGE-TURNS / Color	
		LOWER LEFT	LOWER RIGHT	UPPER LEFT	UPPER RIGHT
Last Action Hero	2	090-5020-30 23-900 -GRN-GRN-	SAME	Not Used	Not Used
Tales from the Crypt	3	090-5032-00 22-1080 -YEL-GRN-	SAME	Not Used	090-5041-00 25-1800 -BLU-GRN-
The Who's Tommy	3	090-5020-30 23-900 -GRN-GRN-	SAME	090-5041-00 25-1800 -BLU-GRN-	Not Used
WWF Royal Rumble	4	090-5032-00 22-1080 -YEL-GRN-	SAME	090-5041-00 25-1800 -BLU-GRN-	SAME
Guns N' Roses	3	090-5032-00 22-1080 -YEL-GRN-	SAME	090-5030-00 23-1100 -ORG-ORG-	Not Used
Maverick	3	090-5032-00 22-1080 -YEL-GRN-	SAME	Not Used	090-5032-00 22-1080 -YEL-GRN-
Mary Shelley's Frankenstein	3	090-5030-00 23-1100 -ORG-ORG-	SAME	Not Used	090-5030-00 23-1100 -ORG-ORG-
Baywatch	4	090-5030-00 23-1100 -ORG-ORG-	090-5020-30 23-900 -GRN-GRN-	090-5025-00 24-1570 -See Note-	090-5030-00 23-1100 -ORG-ORG-
Batman Forever	3	090-5032-00 22-1080 -YEL-GRN-	090-5020-20 22-900 -YEL-YEL-	Not Used	090-5020-30 23-900 -GRN-GRN-
Apollo 13	2	090-5032-00 22-1080 -YEL-GRN-	SAME	Not Used	Not Used
Golden Eye	2	090-5032-00 22-1080 -YEL-GRN-	SAME	Not Used	Not Used
Twister	2	090-5020-20 22-900 -YEL-YEL-	090-5032-00 22-1080 -YEL-GRN-	Not Used	Not Used
ID4: Independence Day	3	090-5032-00 22-1080 -YEL-GRN-	SAME	Not Used	090-5020-30 23-900 -GRN-GRN-
Space Jam †	2	090-5032-00T 22-1080 -YEL-GRN-	090-5020-20T 22-900 -YEL-YEL-	Not Used	Not Used
The Star Wars Trilogy - Special Edition †	2	090-5032-00T 22-1080 -YEL-GRN-	SAME	Not Used	Not Used
The Lost World: Jurassic Park †	2	090-5032-00T 22-1080 -YEL-GRN-	SAME	Not Used	Not Used
The X-Files †	2	090-5032-00T 22-1080 -YEL-GRN-	SAME	Not Used	Not Used
Starship Troopers †	3	090-5030-00T 23-1100 -ORG-ORG-	SAME	Not Used	090-5032-00T 22-1080 -YEL-GRN-
Viper Night Drivin' †	2	090-5030-00T 23-1100 -ORG-ORG-	SAME	Not Used	Not Used
Lost In Space †	2	090-5030-00T 23-1100 -ORG-ORG-	090-5032-00T 22-1080 -YEL-GRN-	Not Used	Not Used
Godzilla †	2	090-5032-00T 22-1080 -YEL-GRN-	SAME	Not Used	Not Used
South Park †	2	090-5030-00T 23-1100 -ORG-ORG-	SAME	Not Used	Not Used
Harley-Davidson® † and Harley-Davidson® 2nd Ed. †	2	090-5032-00T 22-1080 -YEL-GRN-	090-5030-00T 23-1100 -ORG-ORG-	Not Used	Not Used
Striker Xtreme (NFL) †	3	090-5032-00T 22-1080 -YEL-GRN-	090-5030-00T 23-1100 -ORG-ORG-	090-5030-00T 23-1100 -ORG-ORG-	Not Used
Sharkey's Shootout †	3	090-5030-00T 23-1100 -ORG-ORG-	SAME	090-5030-00T 23-1100 -ORG-ORG-	Not Used
High Roller Casino †	2	090-5020-20T 22-900 -YEL-YEL-	090-5032-00T 23-1080 -YEL-GRN-	Not Used	Not Used
Austin Powers™ †	2	090-5020-30 23-900 -GRN-GRN-	090-5030-00T 23-1100 -ORG-ORG-	Not Used	Not Used
MONOPOLY® †	3	090-5032-00T 22-1080 -YEL-GRN-	SAME	Not Used	090-5062-00T 23-1500 -BLU-BLU-
Playboy †	2	090-5030-00T 23-1100 -ORG-ORG-	SAME	Not Used	Not Used
RollerCoaster Tycoon™ †	4	090-5032-00T 22-1080 -YEL-GRN-	SAME	090-5067-00T 25-1400 -RED-RED-	090-5068-00T 25-1600 -WHT-WHT
The Simpsons™ Pinball Party †	6* (5 with Flipper Bats)	090-5032-00T 22-1080 -YEL-GRN-	SAME	Not Used	090-5030-00T 23-1100 -ORG-ORG-
		* The Homer Head Assembly is affixed to an Upr. Rt. Style Flipper (no E.O.S. Switch):		Flippers (Mini-Bats) on 2nd Level Playfield:	
			* 090-5020-20T 22-900 -YEL-YEL-	090-5041-00T 25-1800 -BLU-GRN-	090-5025-00T 24-1570 -See Note-
Terminator® 3: Rise of the Machines™ †	2	090-5032-00T 22-1080 -YEL-GRN-	SAME	Not Used	Not Used
The Lord of the Rings™ †	2	090-5020-20T 22-900 -YEL-YEL-	SAME	Not Used	Not Used
Ripley's Believe It or Not!® †	3	090-5032-00T 22-1080 -YEL-GRN-	SAME	Not Used	090-5067-00T 25-1400 -RED-RED-

† Coil Part N^os ending with a "T" signifies the Diode is on the top of the lug (on the coil-winding side); Coil Part N^os ending with a "B" signifies the Diode is on the bottom of the lugs.



APPENDIX F

Motor Specification (White Star Board System* Only) Table



Game Name	Function	Specifications	Part Number
Apollo 13	Rocket Up/Down Movement	Bowman Motor 24VAC 60Hz 3W 6 RPM CCW	515-6383-00 <i>incl. Connector</i>
	Moon Unit Rotational Orbit	Multi Products Motor 24VAC 50/60Hz 3W 6 RPM CCW	515-6487-00 <i>incl. Connector</i>
	Shaker	Johnson Motor (Vibrator) 10.5VDC 10 AMP 2950 RPM CW	041-5029-00 MOTOR ONLY
Golden Eye	Satellite Left/Right Movement	Bowman Motor 24VAC 60Hz 3W 6 RPM CW	515-6528-00 <i>incl. Connector</i>
Twister	Spinning Disc with Magnet	Multi Products Motor 24VAC (041-5026-00) 50/60Hz 3W 325 RPM CCW	515-6347-00 <i>incl. Connector</i>
	Backbox Fan (Tornado Wind)	Multi Products Motor 24VAC (041-5052-00) 50/60Hz 3W 3600 RPM CW	515-6531-00 <i>incl. Connector</i>
ID4: Independence Day	Alien Head Open/Close Movement	Servo Motor (94322)	041-5045-00 MOTOR ONLY
<i>SPACE JAM (NO MOTOR USED)</i>			
The Star Wars Trilogy - S.E.	X-Wing Left/Right Movement	Bowman Motor 24VAC (041-5058-00) 60Hz 3W 10 RPM CCW	515-6383-01 <i>incl. Connector</i>
The Lost World: Jurassic Park	Snagger & Center Link Lift Up/Down Movement	Multi Products Motor 20VDC (041-5059-03) 9 RPM Non-Directional	515-6715-03 <i>incl. Connector</i>
	Shaker	Johnson Motor (Vibrator) 10.5VDC 10 AMP 2950 RPM CW	041-5029-00 MOTOR ONLY
The X-Files	X-File Cabinet Lift Up/Down Movement	Multi Products Motor 20VDC 9 RPM CCW	041-5057-00 MOTOR ONLY
Starship Troopers	Warrior Bug Forward/Reverse Movement	Haydon Switch & Instrument, Inc. Stepper Motor 12VDC 4.6W (041-5062-00), Series 36000: 1.4"ø (Non-Captive Shaft not included) HSI #36864-12 (Unipolar) Travel per Step: .004 Step Angle: 15°	515-6794-00 <i>incl. Connector</i> Requires 7" Shaft: 530-5503-00
<i>VIPER NIGHT DRIVIN' (NO MOTOR USED)</i>			
Lost In Space	Spinning Disc with Magnet	Multi Products Motor 24VAC (041-5046-00) 50/60Hz 3W 325 RPM CCW	515-6347-00 <i>incl. Connector</i>
Godzilla	Shaker ‡	Multi #3811 0630 Motor (Vibrator) 12VDC 3100 RPM CW (w/DRL PTS) ‡	041-5029-01 MOTOR ONLY
<i>SOUTH PARK (NO MOTOR USED)</i>			
Harley-Davidson® 1st through 3rd Editions	Shaker ‡	Multi #3811 0630 Motor (Vibrator) 12VDC 3100 RPM CW (w/DRL PTS) ‡	041-5029-01 MOTOR ONLY
	Motorcycle Lift Up/Down Movement	Autotrol 24VAC (041-5072-02) 20 RPM CCW	515-7025-00 <i>incl. Connector</i>
Striker Xtreme (NFL)	Goalie (Linebacker) Left to Right Movement	Multi #3590 12VDC (041-5075-00) 60 RPM	515-7071-00 <i>incl. Connector</i>
Sharkey's Shootout	Mystery Ball Rotating Movement	Hankscraft Motor Model-E 24VAC (041-5076-00) 50/60Hz 3W 20 RPM CW	515-7095-00 <i>incl. Connector</i>
High Roller Casino	Roulette Wheel Rotating Movement	Multi Products Motor 20VDC (041-5078-00) 17 RPM CCW	515-7153-00 <i>incl. Connector</i>
	Up/Dn. Ramp in Slot Mach. Lift Up/Down Movement	Haydon Switch & Instrument, Inc. Stepper Motor 12VDC 4.6W (041-5062-00), Series 36000: 1.4"ø (Non-Captive Shaft not included) HSI #36864-12 (Unipolar) Travel per Step: .004 Step Angle: 15°	515-6794-00 <i>incl. Connector</i> Requires Shaft 4¼": 530-5503-01
Austin Powers™	Time Machine Rotating Movement	Multi Products Motor 24VAC (041-5079-00) 50/60Hz 20RPM CCW	515-7141-00 <i>incl. Connector</i>
	Laser Beam Left to Right Directional	Autotrol Motor 24VAC (041-5081-00) 50/60Hz 4W 10RPM Bi-Directional	515-7171-00 <i>incl. Connector</i>
	Dr. Evil Target Lift Up/Down Movement	Hankscraft Motor Model-E 24VAC (041-5030-00) 50/60Hz 6RPM CCW	515-5900-00 <i>incl. Connector</i>
Monopoly®	Mini-Flipper (Waterworks) Rotating Movement	Multi Prod. Motor & Gear Box #7000 EX00159A 20VDC 50/60Hz 85RPM CC/CCW	041-5083-00 MOTOR ONLY
Playboy	Triangular Billboard Rotating Movement	Autotrol Motor (BD511 150-1387) 24VAC 50/60Hz 12RPM Bi-Directional	041-5086-02 MOTOR ONLY
	Centerfold Mechanism Open/Close Movement	Multi Products (3680) Motor 12v DC 10/12 RPM CC/CCW	041-5075-04 MOTOR ONLY
	Tease Drop Screen Lift Up/Down Movement	Haydon Switch & Instrument, Inc. Stepper Motor 12VDC 4.6W (041-5062-00), Series 36000: 1.4"ø (Non-Captive Shaft not included) HSI #36864-12 (Unipolar) Travel per Step: .004 Step Angle: 15°	515-6794-00 <i>incl. Connector</i> Requires 7" Shaft: 530-5503-00

‡ Please Note: ".01" Shaker Motor is **Not Compatible** with old Shaker Motor 041-5029-00 (Shaker Motor Assy. 515-5893-00). THIS NEW MOTOR CAN ONLY BE USED IN NEW SHAKER MOTOR ASSY. 515-5893-01.

Table continued on the next page.





APPENDIX F

Motor Specification (White Star Board System* & S.A.M. System** Only) Table



Game Name	Function	Specifications	Part Number
ROLLERCOASTER TYCOON™ (NO MOTOR USED)			
THE SIMPSONS™ PINBALL PARTY (NO MOTOR USED)			
Terminator® 3: Rise of the Machines™	Backbox Ball Shooter Up/Down Movement	Multi Products Motor 24VAC (041-5079-01) 21 RPM CW	515-7317-00 <i>incl. Connector</i>
The Lord of the Rings™	Balrog (Motor & Gate) Open/Close Movement	Multi Prod. Motor 20VDC Series 600B (or equiv.) 50/60Hz 10 RPM Bi-Directional	041-5088-01 MOTOR ONLY
RIPLEY'S BELIEVE IT OR NOT!® (NO MOTOR USED)			
Elvis®	Elvis™ Front/Back Movement	Haydon Switch & Instrument, Inc. Stepper Motor 12VDC 10W (041-5089-00), (Non-Captive Shaft not included) HSI #46868-12-002	500-6809-00 <i>incl. Connector</i> Requires 7.25" Shaft: 530-5658-00
	▶▶▶ OPTIONAL ◀◀◀ Shaker	Multi #3811 0630 Motor (Vibrator) 12VDC (041-5029-01) 3100 RPM (w/DRL PTS)	515-5893-01 <i>incl. Connector</i>
The Sopranos™	Bada Bing! Girls x2 Rotating Posts Movement	Autotrol Synchronous Motor 24VAC 4W 50/60Hz 45.7/54.9 RPM Bi-Directional	041-5092-00 <i>w/1" Shaft + 12" Leads</i>
NASCAR® and [NDSE]	Back Panel Rotating (Car) Windmill (Skill Ball Enter)	Multi Products Motor & Gear Box 20VDC Model #8000 (EX-04-073) 10 RPM	041-5093-00 MOTOR ONLY
Grand Prix	Back Panel Rotating (Car) Windmill (Skill Ball Enter)	Multi Products Motor & Gear Box 20VDC Model #8000 (EX-04-073) 10 RPM	041-5093-00 MOTOR ONLY
World Poker Tour™ (WPT) (NO MOTOR USED)			
The Simpsons™ Kooky Carnival	Bart on Skateboard Left/Right Movement	Multi Products Motor with Crank 24VAC (041-5095-01) 50/60Hz 3W 14 RPM	500-6947-01 <i>incl. Connector</i>
	Left & Right Ramps Up/Down Movement	Multi Products Motor 24VAC (041-5048-01) 50/60Hz 3W 15 RPM CCW (Qty. 2 in game)	515-7558-00 <i>incl. Connector</i>
	Shaker <i>(details in SKC Manual, Page 24)</i>	Multi #3811 0630 Motor (Vibrator) 12VDC 3100 RPM (w/DRL PTS)	041-5029-01 MOTOR ONLY
©Disney's Pirates of the Caribbean	Spinning Disk	Multi #3811R 0630 Motor (Vibrator) 12VDC (041-5029-04) 3100 RPM (w/DRL PTS) -04 is RoHS compliant; can substitute with -01 domestic	511-5024-04 <i>incl. Connector</i>
	Pirate Ship Sinking/Raising Movement	Multi Products Motor & Gear Box 24VDC Model #7000-DCM 12 RPM	041-5101-00 MOTOR ONLY
Family Guy™	Stewie Figurine Left & Right Movement	Stepper Motor NPM PF35T-48D4STD 5V RVB (041-5102-00 Reference Only)	511-5043-00 <i>incl. Connector</i>
Spider-Man™	Doc Ock, Sandman & 3-Bank Up/Down Movement	Sync. Motor 24VAC 50/60Hz 3W 12 RPM CW (041-5103-00 Reference Only)	511-5063-00 <i>incl. Connector</i>
	▶▶▶ OPTIONAL ◀◀◀ Shaker Motor Kit 502-5027-00	Multi #3811R 0630 Motor (Vibrator) 12VDC (041-5029-04) 3100 RPM (w/DRL PTS) -04 is RoHS compliant; can substitute with -01 domestic	515-5893-01 <i>incl. Connector</i>



APPENDIX F

Motor Specification Table

The following table only list games that used motors. Part Numbers starting with "515-" will include the Wiring Harness & Connector.

Game Name	Function	Specifications	Part N ^o
ABC Monday Night Football	Goal Post Up/Down Movement	Motor 24v A.C. 60 RPM CW	515-5222-00
Phantom of the Opera	Organ Up/Down Movement	Bowman Motor 24v 60Hz 3W 11 RPM CCW	515-5256-00
Checkpoint	Mag Wheel (in Backbox)	Motor D.C. (KEN)	041-5005-00
	Shaker	Johnson Motor (Vibrator)	041-5002-00
Teenage Mutant Ninja Turtles	Spinning Pizza Ball Deflector	Gear Motor 24v A.C. 325 RPM CW	515-5397-00
Batman	Bar Target Up/Down Movement	Bowman Motor 24v 60Hz 3W 11 RPM CCW	515-5256-00
Star Trek 25th Anniversary	Swinging Target	Bowman Motor 24v 22½ RPM	515-5534-00
	Transporter F/X	Gear Motor 24v A.C. 3½ RPM	500-5421-00
	Cooling Fan (for Transporter F/X)	4½" Motor 12v	041-5014-00
Lethal Weapon 3	Spinning Light	Motor 2½ v A.C. 4000 RPM CCW	041-5017-00
Star Wars	Bar Target Up/Down Movement	Bowman Motor 24v 60hz 3W 11 RPM CCW	515-5256-00
	R2D2 Robot Left/Right Movement	Bowman Motor 24v A.C. 22½ RPM CW	515-5571-00
	Death Star Rotation	Bowman "G" Motor 24v A.C. 60Hz 6 RPM CW	515-5570-00
Rocky & Bullwinkle & Friends	Nell Log "Cutting Blade" Forward/Back Movement	Autotrol Model E Motor 24v 60hz 4W 3 RPM CCW	041-5023-00
Jurassic Park	T-Rex Left/Right Movement	Multi Motor 5v D.C.	041-5025-00
	T-Rex Up/Down Movement	Bowman Motor 24v 11 RPM CW	041-5026-00
	Shaker	Johnson Motor (Vibrator)	041-5002-00
Last Action Hero	Crane Left/Right Movement	Multi Products Motor 12v D.C. #3312 OSC	041-5027-00
	Shaker	Johnson Motor (Vibrator) 10.5v D.C. 10 AMP 2950 RPM CW	041-5029-00
Tales from the Crypt	Tombstone Up/Down Movement	Bowman Motor 24v A.C. 6 RPM CCW	515-5900-00
	Shaker	Johnson Motor (Vibrator) 10.5v D.C. 10 AMP 2950 RPM CW	041-5029-00
The Who's Tommy	Mirror Up/Down Movement	Bowman Motor 24v A.C. 6 RPM CCW	515-5900-00
	Flipper Blinders	Servo Motor (94102)	041-5032-00
	Spinning Airplane Propellers	Motor D.C.	041-5033-00
WWF Royal Rumble	Shaker	Johnson Motor (Vibrator) 10.5v D.C. 10 AMP 2950 RPM CW	041-5029-00
Maverick, The Movie	Turning Paddle Wheel	Motor 24v A.C. 10 RPM	041-5036-00
Mary Shelley's Frankenstein	Creature Head Left/Right Movement	Servo Motor (94102)	041-5032-00
Batman Forever	Cannon Left/Right Movement	Bowman Motor 24v A.C. 60Hz 3W 6 RPM CCW	515-6383-00

APPENDIX G

Part Number Prefix Classification Codes

I. Electrical Source, Energy & Signal Converters

- 010- Transformers
- 031- Speakers
- 090- Solenoids (Coils)
- 150- Filters, Outlets, Varistors, Thermistors
- 200- Fuses

II. Conductors, Connectors & Insulators

- 034- Line Cords
- 036- Cable Assemblies & Wiring Harnesses
- 041- Motors
- 045- Connectors (All Types)
- 055- Lugs (M/F), Pins (M/F), Discs, Ring Terminals, Terminal Strips, etc.
- 060- Polarizing Keys and Conn. Covers
- 077- Lamp Sockets

III. Circuits & Circuit Elements

- 100- ICs
- 110- Transistors
- 112- Diodes (All Types including LEDs & Modules)
- 121- Resistors
- 123- Resistors (Variable & Adjustable)
- 124- Regulators & Bridge Rectifiers
- 125- Capacitors (Radial Lytics & Ferrites)
- 126- Piezo Crystal
- 127- Heatsinks
- 130- Capacitors (Tectates & Ceramics)
- 140- Oscillators (Clocks/Crystals)
- 165- Light Bulbs
- 180- Switches
- 181- Switch Membranes (Pads) & Piezo Sensors
- 190- Relays
- 960- EPROM (*Raw Part*)
- 965- EPROM (*Programmed Part*)

IV. Bolts, Screws, Nuts, Washers & Nails

- 231- Bolts
- 232- Screws (Pan Head)
- 234- Screws (HWH)
- 237- Screws (Misc.)
- 240- Nuts (Misc.)
- 242- Washers (Flat, Round)
- 244- Washers (Split Lock)
- 245- Nyloners
- 246- Washers (Lockers, External Tooth)
- 281- Nails

V. Mechanical Components

- 249- Rivets
- 251- Pins (Dowel), Finishing Nails, Hairpins, Spring Pins and Clevis Pins
- 254- Stand-Offs, Spacers and Shims
- 260- Steel Ball (All Types Steel, Glowing, Delrin, etc.)
- 265- Springs (Extension)
- 266- Springs (Compression)
- 267- Springs (Torsion)
- 269- Springs (Washers - Belleville, Wave)
- 270- Retaining Rings
- 280- Grommets, Bushings and Nyloners
- 283- Bearings

VI. Handles, Locks, Catches, Latches, Keys

- 355- Handles, Locks, Catches, Latches and Keys

VII. Fabricated Parts

- 390- Hinges
- 501- Coin Doors
- 515- Sub-Assemblies
- 520- Printed Circuit Boards (PCBs)
- 522- Display Glass
- 525- Wood Parts
- 530- Screw Machined Parts
- 535- Fabricated Parts
- 545- Molded (Extruded) Plastic and Rubber Parts (Rings, Sleeves, etc.)
- 550- Molded (Inserts)

VIII. In-House Assemblies

- 500- End Product (Systems and Models)
- 502- Kits (Created In-House)
- 505- Cabinets (complete)
- 510- Riveted Sub-Assemblies (In-House)
- 511- Sub-Assemblies (In-House)
- 515- Sub-Assemblies*

*2 or more 515-'s but still a sub-assembly.

IX. Bulk Materials

- 600- Braided Wire & Ground Straps
- 601- Stranded Wire
- 602- Ribbon Cable
- 604- Telephone Line Cord
- 605- Sleeving (Shrink Tubing)
- 625- Velcro (non-adhesive)
- 626- Foam Rubber, Foam Pads, Rubber Bumpers (Blue Pads), Tape (All Types) Velcro (adhesive) and String / Rope















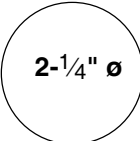
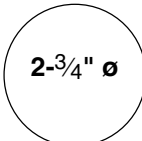
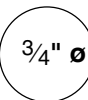
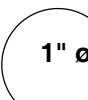
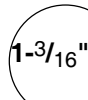
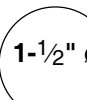
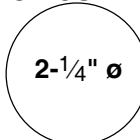
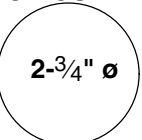

X. Miscellaneous

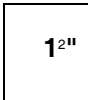
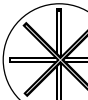
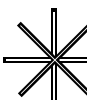
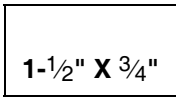
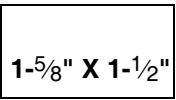
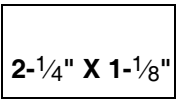
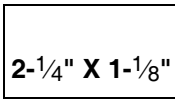
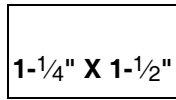
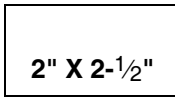
- 000- Tools (*see also 777-*) and Supplies
- 040- Clamps, Ties & Clips
- 042- Pulleys
- 091- Coin Mechs
- 205- Fuse Holders
- 631- Staples
- 660- Glass (Playfield, Backglass, etc.)
- 675- Cleaners
- 705- Packing & Shipping Items
- 755- Instruction, Coin Cards, Ins. Sheets
- 756- Information Sheets, Service Bulletins, Instruction Sheets in Kits and Templates
- 777- Tools (Wrenches and Drivers)
- 780- Manuals
- 802- Decal Kits (comprised of 820's)
- 820- Decals, Mylar and Labels (Sheets/Sets)
- 803- Plastic Kits (comprised of 830's)
- 830- Plastic Pieces (Butyrate Sheets/Sets)
- 880- Toys, Models, Figurines, etc.
- 900- Game Posters

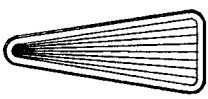
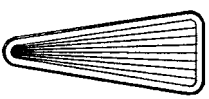
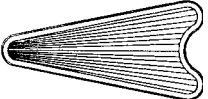
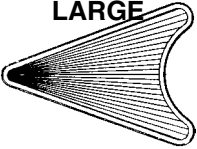

APPENDIX H

Playfield Inserts (Plastic Light Covers)

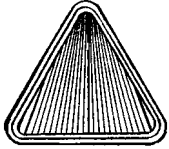
Patterns: STARBURST  STIPPLE 	STARBURST CIRCULAR  550-5000-XX	STARBURST CIRCULAR  550-5001-XX	STARBURST CIRCULAR  550-5002-XX	STARBURST CIRCULAR  550-5003-XX	STARBURST CIRCULAR  550-5004-XX
STARBURST CIRCULAR  550-5005-XX	STARBURST CIRCULAR  550-5006-XX	PLAIN CIRCULAR  550-5007-XX	PLAIN CIRCULAR  550-5008-XX	PLAIN CIRCULAR  550-5009-XX	PLAIN CIRCULAR  550-5010-XX
PLAIN CIRCULAR  550-5011-XX	PLAIN CIRCULAR  550-5012-XX	STIPPLE CIRCULAR  550-5048-XX	STIPPLE 1" SQUARE  550-5019-XX	ROLLOVER BUTTON BASE  550-5026-XX	WHITE STAR (only in white)  545-5015-00
STIPPLE RECTANGULAR  550-5018-XX	STIPPLE RECTANGULAR  550-5051-XX	STARBURST RECTANGULAR  550-5044-XX	PLAIN RECTANGULAR  550-5049-XX	PLAIN RECTANGULAR  550-5050-XX	PLAIN RECTANGULAR  550-5063-XX
STARBURST MINI SHIELD  550-5024-XX	STARBURST LARGE SHIELD  550-5025-XX	MINI HOT DOG  550-5020-XX	BEVEL HOT DOG  550-5021-XX	PLAIN HOT DOG  550-5022-XX	BANANA  550-5023-XX
STARBURST ARROW-SMALL  550-5013-XX	STARBURST ARROW-LARGE  550-5070-XX	STARBURST ARROW-HEAD SMALL  550-5014-XX	STARBURST ARROW-HEAD LARGE  550-5015-XX	STARBURST BULLET  550-5016-XX	STARBURST TRIANGLE  550-5017-XX

Note: The shapes and sizes shown above are not to scale. Some shapes may no longer be available in every color.

Instructions: Parts which may come in various colors (i.e. targets, some posts, playfield inserts, etc.) end in a 2-digit number which correspond to the color of that part. The "-XX" in part number which may come in various colors should be replaced with the desired 2-Digit number corresponding to the color desired below. *Not all colors may be available.*

PLASTIC PART COLOR CHART											
Nº	Color	Nº	Color	Nº	Color	Nº	Color	Nº	Color	Nº	Color
-00	Black or Solid Clear	-03	Amber	-06	Yellow	-09	Purple	-12	Fluor. Blue	-15	Luminescent
-01	Clear	-04	Green	-07	Orange	-10	Fluor. Orange	-13	Teal Green	-16	Gold
-02	Red	-05	Blue	-08	White	-11	Fluor. Green	-14	Gray	-17	Trans. Brown

APPENDIX I

Stand-Up Targets

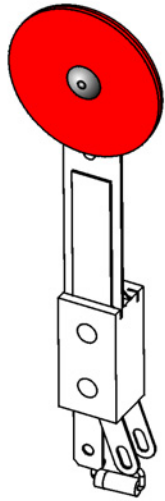

112-5003-00
Switch Diode, 1N4004
(all Stand-Up Targets)

515-5966-XX
1" ROUND STAND-UP
SWITCH & TARGET
RIVETED ASSEMBLY*

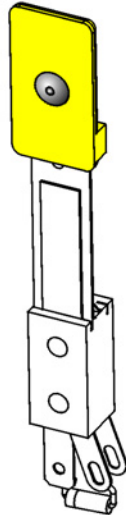

STANDARD
515-5967-XX or **ANTI-LOFT**
515-7581-XX
1" X 1/2" NARROW STAND-UP
SWITCH & TARGET
RIVETED ASSEMBLY*

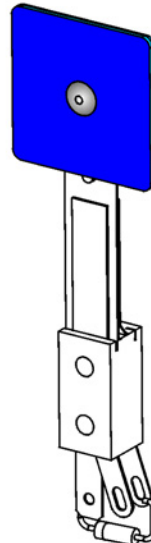

515-5162-XX
1" X 1" SQUARE STAND-UP
SWITCH & TARGET
RIVETED ASSEMBLY*

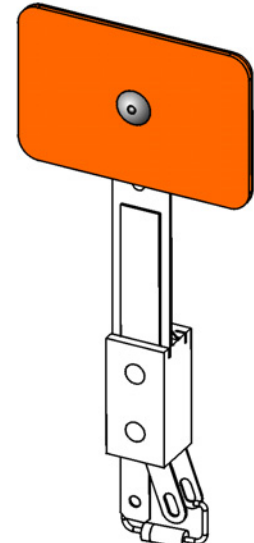

515-6027-XX
1" X 1-1/2" RECTANGLE STAND-UP
SWITCH & TARGET
RIVETED ASSEMBLY*

**Note: Does not include the Switch Back Plate, Mounting Bracket or screws.*

To include the Switch Back Plate, Foam Pad, and Switch Mounting Bracket assembled, use the follow assembly part numbers (replace the -XX with 2-digit number from chart):

- 500-5835-XX : 1" ROUND TARGET 500-5857-XX : 1" X 1/2" NARROW TARGET 500-5232-XX : 1" X 1" SQUARE TARGET 500-5321-XX : 1" X 1-1/2" RECT. TARGET

REAR VIEW 515-5967-06 SHOWN

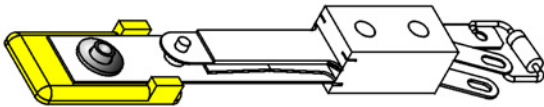

SHOWN BELOW : 500-5857-06
1" X 1/2" NARROW STAND-UP
TARGET ASSEMBLY COMPLETE

626-5029-00
Foam Pad, Square
.44" X .44" X .125" Thick (Self-Adhesive)**

-XX REPLACE WITH 2-DIGIT FOR COLOR:

- 00 Black
- 01 Clear
- 02 Red
- 03 Amber
- 04 Green
- 05 Blue
- 06 Yellow
- 07 Orange
- 08 White
- 09 Purple
- 10 Fluor. Orange
- 11 Fluor. Green
- 12 Fluor. Blue
- 13 Teal Green
- 14 Gray
- 15 Luminescent
- 16 Gold

Note: Not all colors available.

SHOWN BELOW : 500-6985-04

1" X 1/2" NARROW ANTI-LOFT
STAND-UP TARGET
ASSEMBLY COMPLETE

626-5069-00
Foam Pad, Rectangle
.6" X .4" X .25" Thick (Self-Adhesive) ‡

535-9823-01
Switch Back
Plate ‡

** Note:
Use with all Switch
& Targets THIS page
except for 515-7581-XX

‡ Note: Use only with
515-7581-XX Switch &
Target Assembly unless
otherwise noted.

535-6896-00
Bracket, Switch
Mounting
(all targets THIS page)

535-6896-00
Bracket, Switch
Mounting
(all targets THIS page)

237-5976-05
#6-32 X 3/4" SHWH Sc.
(all targets THIS page)

237-5976-05
#6-32 X 3/4" SHWH Sc.
(all targets THIS page)

515-5967-XX
1" X 1/2" NARROW
STAND-UP (STANDARD)
SWITCH & TARGET
RIVETED ASSEMBLY*

515-7581-XX
1" X 1/2" NARROW
STAND-UP TALL
SWITCH & TARGET
RIVETED ASSEMBLY*

ORDERING NOTE: 515-7581-XX (500-6985-XX)

differences from 515-5967-XX (500-5857-XX) are:

1. Switch & Target Taller (Target sits higher over P/F)
2. Switch Back Plate differs (bend, shape & tab)
3. Foam Pad differs (thicker, taller, different type foam)

**Note: Does not include the Switch Back Plate, Mounting Bracket or screws.*

APPENDIX I

Modular Stand-Up Targets

R means «Target Insert» is reversed, allowing for Rear Mounted application.

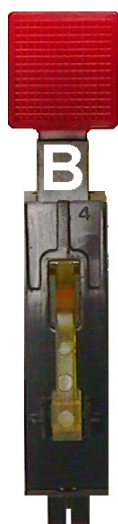
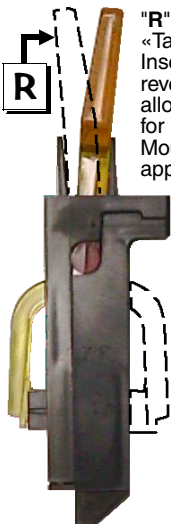

Take Note:

- Items A-E come in various colors. These targets may not be available in every color. The "-XX" in should be replaced with the desired 2-Digit number for the color desired as described in the Color Chart below. As of print date, the following colors were used :
 -01 Clear (A, D); -02 Red (A, B, C, D, E); -03 Amber (D, E);
 -04 Green (A, B); -05 Blue (C); -06 Yellow (A, C),
 -09 Purple (B, D); -11 Fluorescent Green (A, B, D)
- For location(s) and type of Stand-Up Targets used, if any, see Section 4, Chapter 1, Parts Identification & Location.

XX REPLACE WITH 2-DIGIT FOR COLOR:

- 00 Black
 - 01 Clear
 - 02 Red
 - 03 Amber
 - 04 Green
 - 05 Blue
 - 06 Yellow
 - 07 Orange
 - 08 White
 - 09 Purple
 - 10 Fluor. Orange
 - 11 Fluor. Green
 - 12 Fluor. Blue
 - 13 Teal Green
 - 14 Gray
 - 15 Luminescent
 - 16 Gold
- Note: Not all colors available.*

Nr.	STAND-UP TARGET PARTS	SPI PART Nr.
A	Modular Stand-Up Target Narrow Assy.	500-6138-XX
	Stand-Up Target Narrow (Insert)	545-6138-XX
B	Modular Stand-Up Target Square Assy.	500-6139-XX
	Stand-Up Target Square (Insert)	545-6139-XX
C	Modular Stand-Up Target Rectangle Assy.	500-6228-XX
	Stand-Up Target Rectangle (Insert)	545-6228-XX
D	Modular Stand-Up Target Round Assy.	500-6075-XX
	Stand-Up Target Round (Insert)	545-6075-XX
E	Mod. Stand-Up Target 1" Spherical Assy.	500-6189-XX
	Stand-Up Target 1" Spherical (Insert)	545-6189-XX

To Replace the « Target Insert » or change Target Orientation :

Items A-E Note: For the Target Assembly use the "500-" SPI Part Number(s) shown in the Parts Table below. To receive the Target Assembly with the « Target Insert » « Reversed » simply add a "R" at the end of the Part Number. See Side View picture left to compare (dashed line shows target reversed). For just the «Target Insert» use the "545-" SPI Part Number.

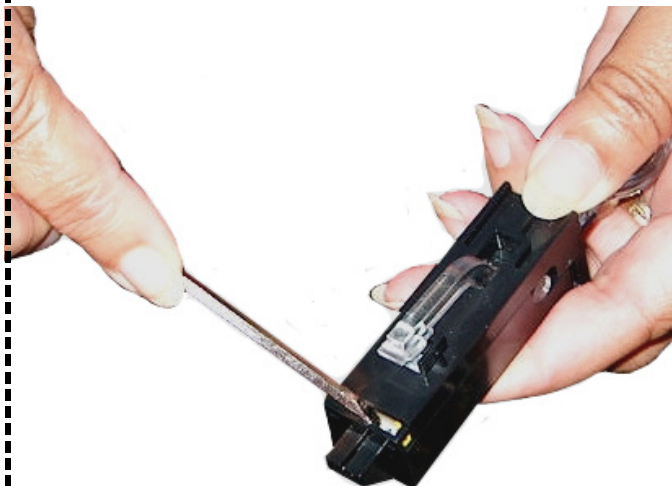

To reverse it yourself or to just change the insert:

- With a small flat head screwdriver, push into the small tab at the bottom of the target front and give a slight twist motion to "pop" the two halves.

- Push the Target Insert bottom in at the same time while you slide the top (front) part up, then let go of the insert as the two halves come apart.

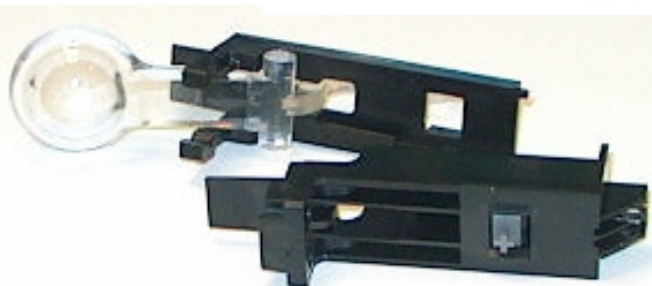

- Replace target or reinsert it into the other size while sliding the two halves back together.

Note: If you were reversing the orientation, don't forget to also turn the Switch Actuator PCB 180°. Test Switch.

APPENDIX J

Coin Cards (USA & International Pricing Defaults) ▶ For Yellow Stock add -Y to the Part Number

If more than one Pricing Scheme is available for countries listed, the **F.** listed beside the option, denotes the Factory Default Setting.

FOR VIEWS OF THE LATEST or OPTIONAL USA, INTERNATIONAL / EURO AND CUSTOM COIN CARDS, VISIT OUR WEBSITE.

Not Shown USA 755-5400-10 Tournament Option \$2 = X1; 755-5400-11 Tournament Option \$1.50 = X1

USA 10 F. 755-5400-11 Front		USA 10 755-5400-11 Back		USA 2-7 or CANADA 755-5400-02 Front		FOR CUSTOM PRICING † 755-5400-01, -02 or -04 Back		USA 3 with ToPS™ 755-5400-03 or -09 Front		USA 5 with ToPS™ 755-5400-03 Back / -08 Front	
AUSTRALIA 1 F. 755-5406-00 Front		AUSTRALIA 2 755-5406-00 Back		CROATIA 755-5410-00 Front		FOR CUSTOM PRICING † 755-5410-00 Back		DENMARK 1 F. 755-5402-00 Front		DENMARK 2 755-5402-00 Back	
JAPAN 1 755-5408-01 Front		JAPAN 2 F. 755-5408-01 Back		MIDDLE EAST 755-5400-06 Front		ANY COUNTRY CAN USE 755-5400-06 Back		NEW ZEALAND 1 F. 755-5406-00 Back		NEW ZEALAND 2 755-5406-00 Front	
NORWAY 1 F. 755-5403-01 Front		NORWAY 2 755-5403-01 Back		RUSSIA F. 755-5411-00 Front		RUSSIA (ALTERNATE) 755-5411-00 Back		SOUTH AFRICA 755-5409-01 Front		FOR CUSTOM PRICING † 755-5409-01 Back	
SWEDEN 1 F. 755-5404-00 Front		SWEDEN 2 755-5404-00 Back		SWITZERLAND 1 F. 755-5405-00 Front		SWITZERLAND 2 755-5405-00 Back		TAIWAN 755-5412-00 Front		FOR CUSTOM PRICING † 755-5412-00 Back	
UK 1 755-5407-00 Front		UK 3 755-5407-00 Back		UK 5 F. 755-5407-01 Front		FOR CUSTOM PRICING † 755-5407-01 Back		Appendix J Notes: 1. Coin Card on Game is determined by original shipping country destination. 2. Optional Coin Card(s), are available via your distributor or via free download @ www.sternpinball.com/coinagecards.shtml . Older style Coin Cards (foreign or domestic) not available on our website or no longer available through your distributor, are obsolete. 3. Coin Cards which have a Blank Backside can be used for †Custom Pricing.			

Not Shown EURO 755-5401-20 Tournament Custom (can fill in your own pricing).

EURO 1 755-5401-01 1-Side Only		EURO 2 755-5401-02 1-Side Only		EURO 3 755-5401-03 1-Side Only		EURO 4 755-5401-04 1-Side Only		EURO 5 755-5401-05 1-Side Only		EURO 6 755-5401-06 1-Side Only	
EURO 7 755-5401-07 1-Side Only		EURO 8 755-5401-08 1-Side Only		EURO 9 755-5401-09 1-Side Only		EURO 10 755-5401-10 1-Side Only		EURO 11 755-5401-11 1-Side Only		EURO 12 755-5401-12 1-Side Only	

▶ EURO FACTORY DEFAULT SUMMARY TABLE ◀

EURO 1	EURO 2	EURO 3	EURO 4	EURO 5	EURO 6	EURO 7	EURO 8	EURO 9	EURO 10	EURO 11	EURO 12
BELGIUM ITALY 1 PORTUGAL	GERMANY 2	NETHERLANDS SPAIN			GREECE		FINLAND	AUSTRIA	FRANCE		

Section 3, Chapter 4, GO TO ADJUSTMENTS MENU, Adj. 18, Game Pricing, USA & International (non-Euro) and Euro 1-12 Summary & International (Euro) Standard Pricing Select Tables, summarizes Standard or Custom Pricing Schemes & the Dip Switch Setting required.





APPENDIX A



Pinball Game Firmware (White Star Board System* Only) Table

See website for the latest International Code or Updated USA version / checksums

Table listing firmware details for games: Apollo 13, Golden Eye, Twister, ID4: Independence Day, Space Jam, The Star Wars Trilogy - Special Edition (S.E.), The Lost World: Jurassic Park, The X-Files, Starship Troopers, Viper Night Drivin', Lost In Space, Godzilla, South Park.

Table listing firmware details for games: Harley-Davidson, Striker Xtreme, NFL, Sharkey's Shootout, High Roller Casino, Austin Powers, MONOPOLY, Playboy, RollerCoaster Tycoon, The Simpsons Pinball Party, Terminator@ 3: Rise of the Machines, The Lord of the Rings.

Sound & Voice 1-4 identical to above H-D@ Original.

footnotes : 1 — 8 see the bottom of the next page (A2).





APPENDIX A

Pinball Game Firmware (White Star Board System* & S.A.M. System** Only) Table



See website for the latest International Code or Updated USA version / checksums

ROM	Chip Size	Program Part N°	USA Ver. & Check Sum	Bd. Loc.	Raw Part N°
Ripley's Believe It or Not!® (Notes 7, 8)					
Sound	(512K)	965-0408-81	1.00 \$D93D	U7	960-7001-02
Game ROM	(1M)	965-0409-81	A3.20 \$43FF	U210	960-5009-00
Voice 1	(8M)	965-0410-81	1.00 \$067B	U17	960-5016-00
Voice 2	(8M)	965-0411-81	1.00 \$C8E8	U21	960-5016-00
Voice 3	(8M)	965-0412-81	1.00 \$64C2	U36	960-5016-00
Voice 4	(8M)	965-0413-81	1.00 \$5341	U37	960-5016-00
Display	(4M)	965-0414-81	A3.00 \$DE4B	U5 DC PCB	960-5015-01

Elvis® (Notes 7, 8)					
Sound	(512K)	965-0415-84	1.00 \$8CD2	U7	960-7001-02
Game ROM	(1M)	965-0416-84	A5.00 \$50FF	U210	960-5009-00
Voice 1	(8M)	965-0417-84	1.00 \$538D	U17	960-5016-00
Voice 2	(8M)	965-0418-84	1.00 \$8BCD	U21	960-5016-00
Voice 3	(8M)	965-0419-84	1.00 \$60F8	U36	960-5016-00
Voice 4	(8M)	965-0420-84	1.00 \$14D8	U37	960-5016-00
Display	(4M)	965-0421-84	A5.00 \$A1F6	U5 DC PCB	960-5015-01

The SopranosSM (Notes 7, 8)					
Sound	(512K)	965-0422-85	4.00 \$9B5A	U7	960-7001-02
Game ROM	(1M)	965-0423-85	A5.00 \$5BFF	U210	960-5009-00
Voice 1	(8M)	965-0424-85	3.00 \$F01E	U17	960-5016-00
Voice 2	(8M)	965-0425-85	1.04 \$C14C	U21	960-5016-00
Voice 3	(8M)	965-0426-85	1.04 \$47A3	U36	960-5016-00
Voice 4	(8M)	965-0427-85	1.04 \$ADCD	U37	960-5016-00
Display	(4M)	965-0428-85	A5.00 \$B4BB	U5 DC PCB	960-5015-01

NASCAR® (Notes 7, 8)					
Sound	(512K)	965-0429-86	2.00 \$32B3	U7	960-7001-02
Game ROM	(1M)	965-0430-86	A4.50 \$39FF	U210	960-5009-00
Voice 1	(8M)	965-0431-86	2.00 \$CFFB	U17	960-5016-00
Voice 2	(8M)	965-0432-86	2.00 \$22C0	U21	960-5016-00
Voice 3	(8M)	965-0433-86	2.00 \$5FC8	U36	960-5016-00
Voice 4	(8M)	965-0434-86	2.00 \$2902	U37	960-5016-00
Display	(4M)	965-0435-86	A4.00 \$92BD	U5 DC PCB	960-5015-01

Grand Prix (Notes 7, 8)					
Sound	(512K)	965-0429-91	V1.00 \$6F89	U7	960-7001-02
Game ROM	(1M)	965-0430-91	A4.50 \$5EFF	U210	960-5009-00
Voice 1	(8M)	965-0431-91	1.00 \$CE5E	U17	960-5016-00
Voice 2	(8M)	965-0432-91	1.00 \$F4C6	U21	960-5016-00
Voice 3	(8M)	965-0433-91	1.00 \$057D	U36	960-5016-00
Voice 4	(8M)	965-0434-91	1.00 \$2646	U37	960-5016-00
Display	(4M)	965-0435-91	A4.00 \$DA8E	U5 DC PCB	960-5015-01

[NDSE] (Notes 7, 8) <i>Call for more info if code update required.</i>					
Sound	(512K)	965-0436-97		U7	960-7001-02
Game ROM	(1M)	965-0437-97		U210	960-5009-00
Voice 1	(8M)	965-0438-97		U17	960-5016-00
Voice 2	(8M)	965-0439-97		U21	960-5016-00
Voice 3	(8M)	965-0440-97		U36	960-5016-00
Voice 4	(8M)	965-0441-97		U37	960-5016-00
Display	(4M)	965-0442-97		U5 DC PCB	960-5015-01

**** GAMES BELOW THIS LINE / NEXT COLUMN ARE S.A.M. SYSTEM GAMES**

TO ORDER MEMORY STICK WITH GAME FILES FROM YOUR DISTRIBUTOR, USE SPI PART NUMBER 970-0128-00 & INCLUDE THE GAME NAME / LANGUAGE FILE(S) DESIRED.

World Poker Tour™ Pinball (WPT) (Notes 7, 9)					
Boot B-02	(8M)	965-BOOT-SAM	1.04 \$7E62	U9	960-5016-00 unprogrammed
Memory Stick 128MB (970-0128-00)		Version		System	Bin Files:
English + Spanish		1.12AL		1.17+	WPT0112AL.bin
English Only		1.12A		1.17+	WPT0112A.bin
English + French		1.12AF		1.17+	WPT0112AF.bin
French Only		1.12F		1.17+	WPT0112F.bin
German + French		1.12GF		1.17+	WPT0112GF.bin
German Only		1.12G		1.17+	WPT0112G.bin
English + Italian		1.12AI		1.17+	WPT0112AI.bin
Italian Only		1.12I		1.17+	WPT0112I.bin

NOTE: THE TYPICAL SIZE PER UNZIPPED BIN FILE IS 25MB – 30MB+/-

The Simpsons™ Kooky Carnival Redemption (Note 9)					
Boot B-02	(8M)	965-BOOT-SAM	1.04 \$7E62	U9	960-5016-00 unprogrammed
Memory Stick 128MB (970-0128-00)		Version		Bin Files:	
English Only		1.05		SKC0105.bin	
English New Jersey Only		0.09NJ		SKC0090NJ.bin	

NOTE: THE TYPICAL SIZE PER UNZIPPED BIN FILE IS 5.5MB +/-

©Disney's Pirates of the Caribbean Pinball (POTC) (Notes 7, 9)					
Boot B-02	(8M)	965-BOOT-SAM	1.06 \$2014	U9	960-5016-00 unprogrammed
Memory Stick 128MB (970-0128-00)		Version		System	Bin Files:
English + Spanish		1.15AS		1.17+	POTC115AS.bin
English + French		1.15AF		1.17+	POTC115AF.bin
German + French		1.15GF		1.17+	POTC115GF.bin
English + Italian		1.15AI		1.17+	POTC115AI.bin

NOTE: THE TYPICAL SIZE PER UNZIPPED BIN FILE IS 25MB – 30MB+/-

Family Guy™ Pinball (FG) (Notes 7, 9)					
Boot B-02	(8M)	965-BOOT-SAM	2.09 \$10A3	U9	960-5016-00 unprogrammed
Memory Stick 128MB (970-0128-00)		Version		System	Bin Files:
English + Spanish		10.00AL		1.23+	FG1000AL.bin
English + French		10.00AF		1.23+	FG1000AF.bin
English + German		10.00AG		1.23+	FG1000GF.bin
English + Italian		10.00AI		1.23+	FG1000AI.bin

NOTE: THE TYPICAL SIZE PER UNZIPPED BIN FILE IS 25MB – 30MB+/-

Spider-Man™ Pinball (S-M) (Notes 7, 9)					
Boot B-02	(8M)	965-BOOT-SAM	2.10 \$F625	U9	960-5016-00 unprogrammed
Memory Stick 128MB (970-0128-00)		Version		System	Bin Files:
English + Spanish		1.3ES		1.27+	spd_1_30_es.bin
English + French		1.3EF		1.27+	spd_1_30_ef.bin
German + French		1.3GF		1.27+	spd_1_30_gf.bin
English + Italian		1.3EI		1.27+	spd_1_30_ei.bin

NOTE: THE TYPICAL SIZE PER UNZIPPED BIN FILE IS 25MB – 30MB+/-

footnotes:

- 1 ROMs on CPU/Sound Bd.: 520-5136-00 (Stereo) & Display Cont. Bd.: 520-5055-01
- 2 ROMs on CPU/Sound Bd.: 520-5136-10 (Mono) & Display Cont. Bd.: 520-5055-01
- 3 ROMs on CPU/Sound Board: 520-5136-15* (Mono) (*FCC 11-97) & Display Controller Board: 520-5055-02* (*FCC 11-97)



APPENDIX B

Semi-Conductors / Integrated Circuits (I.C.) / Relays Cross-Reference Table

Table No	Type	Source Number	STERN® PINBALL	N T E®	E C G®	Radio Shack®	R C A®
RECTIFICATION, BLOCKING, DAMPENING DIODES AND/OR LIGHT EMITTING DIODES (LEDs)							
1	Diode	1N4001	112-5001-00	NTE552	ECG552	- - - - -	SK9000
	Diode	1N4004	112-5003-00	NTE116	ECG116	276-1103	SK3312
	Diode	1N5401	112-0056-00	NTE5801	ECG5801	276-1143	SK9004
	Diode	1N5404	112-5004-00	NTE5804	ECG5804	276-1144	SK9007
	Diode	T6A10L	112-5006-01	NTE5812	ECG5812	- - - - -	- - - - -
	Diode	FR302	112-5009-00	NTE588	ECG588	- - - - -	SK5014
	Diode, Signal	1N914	112-5014-00	- - - - -	- - - - -	- - - - -	- - - - -
	LED	MT5000UR or TLRH180P (T1-3/4 GaAlAs)	165-5052-00 <i>(old SPI Part No: 165-5100-00)</i>	- - - - -	- - - - -	276-066B	- - - - -
ZENER DIODES							
2	Diode	1N4742A 12v	112-0061-00	NTE142A	ECG142A	276-563	SK12V
	Diode	1N4760B 68v	112-0062-00B	NTE5092A	ECG5092A	- - - - -	SK68V
	Diode	1N4764A 100v	112-0049-00A	NTE5096A	ECG5096A	- - - - -	SK100V
	Diode	1N5228 3.9v	112-0053-00	NTE5007A	ECG5007A	- - - - -	SK3A9
	Diode	1N5234B 6.2v	112-0047-00B	NTE5013A	ECG5013A	276-561	SK6A2
	Diode	1N5379 110v	112-0072-00	NTE5157	ECG5157	- - - - -	SK110X
	Diode	1N6267A 6.8v	112-5011-00	NTE4902	ECG4902	- - - - -	- - - - -
	Diode	1N4752A 33v	112-5010-00A	NTE147A	ECG147A	- - - - -	SK33V
	Diode	1N4736 6.8v 1w	112-5007-00	NTE5071A	ECG5071A	- - - - -	- - - - -
TRANSISTORS - TYPE FET, NPN, PNP AND/OR SCR							
3	FET Trans.	STP20N10L	110-0106-00	NTE2987	ECG2987	- - - - -	- - - - -
	FET Trans.	STP19N06L	110-0088-00	NTE2985	ECG2985	- - - - -	- - - - -
	FET Trans.	VN02N	110-0089-00	- - - - -	- - - - -	- - - - -	- - - - -
	NPN Trans.	2N4401	110-0073-00	NTE85	ECG85	276-2009	SK3124A
	NPN Trans.	2N6427	110-0070-00	NTE48	ECG48	- - - - -	SK4906
	NPN Trans.	MJE340	110-0071-00	NTE157	ECG157	- - - - -	SK3747
	NPN Trans.	MPSA42	110-0082-00	NTE287	ECG287	- - - - -	SK3232
	NPN Trans.	2N3904	110-0069-00	NTE123AP	ECG123AP	276-2009	- - - - -
	NPN Trans.	TIP122	110-0067-00	NTE261	ECG261	276-2068	SK3896
	NPN Trans.	MJE15030	110-0101-00	NTE375	ECG375	- - - - -	SK9118
	PNP Trans.	2N5401	110-0078-00	NTE288	ECG288	- - - - -	SK3434
	PNP Trans.	MJE15031	110-0103-00	NTE292	ECG292	- - - - -	SK3441
	PNP Trans.	MJE350	110-0072-00	NTE374	ECG374	- - - - -	SK9042
	PNP Trans.	MPSA92	110-0100-00	NTE288	ECG278	- - - - -	SK3434
	PNP Trans.	TIP42	110-0068-00	NTE332	ECG332	- - - - -	SK9236
	PNP Trans.	TIP32C	110-0081-00	NTE292	ECG292	- - - - -	SK3441
	PNP Trans.	TIP36C	110-0077-00	NTE393	ECG393	- - - - -	SK3961
	SCR Trans.	2N5060	110-0074-00	NTE5400	ECG5400	276-1067	SK3950
SCR Trans.	SCR2800B	110-0083-00	NTE5461-8	ECG5461-8	- - - - -	- - - - -	
BRIDGE RECTIFIERS (BR)				Comments:			
4	BR (Present)	DB3501 or CM3501	112-5000-00	For White Star I/O Bds., BR = 35 Amp @ 100v P.I.V.			
	RELAYS				Comments:		
5	Relay	FRL-264 D024/02CK	190-5002-00	For PPB, Power Supply, & White Star I/O Boards, Relay = 24v DC 10 Amp DPDT			
	Relay	FRL-264 D006/04CV	190-5001-00	For CPU Boards, Relay = 6v DC 5 Amp 4 Pole DT			





APPENDIX C

Production Start Date, Manual Part No., ROM Size & Positions and Jumper W6 Installed Note‡ (White Star Board System & S.A.M. System Only*)



Game Name White Star Bd. System™	Production Start Date and Manual Part Nr.	CPU/Sound Board Sound U7 512K CPU/Sound Board Game U210 1MB CPU/Sound Board Voice ROMS:				Jumper Installed (‡ see Note)	
		U17	U21	U36	U37		
* Note: For complete Appendix Information for Games Laser War through Batman Forever , see any Service Game Manual between Apollo 13 through Ripley's Believe It or Not! or on-line at our website www.sternpinball.com/parts.htm ; also available on CD-R, 970-2003-00 (The Simpsons™ Pinball Party , T3® and The Lord of the Rings™).							
29	Apollo 13 (A13)	NOV 95 780-5044-00	4MB	4MB	4MB	Not Used	n / a
30	Golden Eye	FEB 96 780-5042-00	4MB	4MB	Not Used	Not Used	n / a
31	Twister	APR 96 780-5041-00	4MB	4MB	Not Used	Not Used	n / a
32	ID4: Independence Day	JUL 96 780-5045-00	4MB	4MB	Not Used	Not Used	n / a
33	Space Jam	OCT 96 780-5043-00	4MB	4MB	4MB	Not Used	n / a
34	The Star Wars Trilogy - Sp. Ed.	FEB 97 780-5056-00	4MB	4MB	Not Used	Not Used	n / a
35	The Lost World: Jurassic Park	JUN 97 780-5053-00	4MB	4MB	Not Used	Not Used	n / a
36	The X-Files	AUG 97 780-5046-00	4MB	4MB	Not Used	Not Used	n / a
37	Starship Troopers	NOV 97 780-5059-00	4MB	4MB	4MB	Not Used	n / a
38	Viper Night Drivin'	FEB 98 780-5035-00	4MB	4MB	4MB	4MB	n / a
39	Lost In Space	JUN 98 780-5060-00	4MB	4MB	4MB	4MB	n / a
40	Godzilla	SEP 98 780-5040-00	4MB	4MB	4MB	4MB	n / a
41	South Park	JAN 99 780-5071-00	8MB	8MB	8MB	8MB	W6
42a	Harley-Davidson®	AUG 99 780-5067-01	8MB	8MB	8MB	8MB	W6
42b	Harley-Davidson® 2nd Ed.	SEP 02 780-5067-10	8MB	8MB	8MB	8MB	W6
42c	Harley-Davidson® 3rd Ed.	OCT 04 780-5087-00	8MB	8MB	8MB	8MB	W6
43a	Striker Xtreme	MAR 00 780-5068-01	8MB	8MB	8MB	8MB	W6
43b	NFL	OCT 00 780-5073-00	8MB	8MB	8MB	8MB	W6
44	Sharkey's Shootout	JUL/OCT 00 780-5072-01	8MB	8MB	8MB	Not Used	W6
45	High Roller Casino	JAN 01 780-5065-00	8MB	8MB	8MB	8MB	W6
46	Austin Powers™	MAY 01 780-5074-00	8MB	8MB	8MB	8MB	W6
47	MONOPOLY®	SEP 01 780-5075-00	8MB	8MB	8MB	Not Used	W6
48	Playboy	FEB 02 780-5076-00	8MB	8MB	8MB	8MB	W6
49	RollerCoaster Tycoon™	AUG 02 780-5078-00	8MB	8MB	8MB	Not Used	W6
50	The Simpsons™ Pinball Party	JAN 03 780-5077-00	8MB	8MB	8MB	8MB	W6
51	T3®: Rise of the Machines™	MAY 03 780-5079-00	8MB	8MB	8MB	8MB	W6
52	The Lord of the Rings™	NOV 03 780-5080-00	8MB	8MB	8MB	8MB	
53	Ripley's Believe It or Not!®	APR 04 780-5081-00	8MB	8MB	8MB	8MB	

‡ Additional Information for Installed Jumper (above games 41-51):

• Installed **W6** so 8MB ROMS can be utilized. See the **CPU/Sound Board Schematic** (Sheet 2 of 3, Address Location 3E) in the games' Service Game Manual. Games 52 - 57 CPU/Sound Board differ than <51 (See Appendix D).

See **Apdx. A** for more detailed information on **Pinball Game Firmware** (ROM Name, Size, Part Numbers, USA Version & Checksum and Board Locations).

Game Name White Star Board System™	Production Start Date and Manual Part Nr.	CPU/Sound Board Sound U7 512K CPU/Sound Board Game U210 1MB CPU/Sound Board Voice ROMS:				
		U17	U21	U36	U37	
54	Elvis®	AUG 04 780-5084-00	8MB	8MB	8MB	8MB
55	The Sopranos™	FEB 05 780-5085-00	8MB	8MB	8MB	8MB
56	NASCAR®	JUL 05 780-5086-00	8MB	8MB	8MB	8MB
57	Grand Prix	SEP 05 780-5091-00	8MB	8MB	8MB	8MB

See **Apdx. A** for more detailed information on **Pinball Game Firmware** (ROM Name, Size, Part Numbers, USA Version & Checksum and Board Locations).

Game Name S.A.M. System	Production Start Date and Manual Part Nr.	S.A.M. System CPU/Sound Board Boot EPROM U9			
		965-BOOT-SAM (Programmed)			
58	World Poker Tour™ (WPT)	JUN 06 780-5088-00	8MB	B-02 V2.1+ chksum \$F625	LOC: U9
59	The Simpsons™ Kooky Carnival	APR 06 780-5090-00	8MB	B-02 V2.1+ chksum \$F625	LOC: U9
60	©Disney's Pirates of the Caribbean	AUG 06 780-5092-00	8MB	B-02 V2.1+ chksum \$F625	LOC: U9
61	Famil Guy™	DEC 06 780-5093-00	8MB	B-02 V2.1+ chksum \$F625	LOC: U9
62	Spider-Man™	MAY 07 780-5094-00	8MB	B-02 V2.1+ chksum \$F625	LOC: U9

Games 58 – current, S.A.M. System : CPU/Sound & I/O Power Driver PCBs differ than White Star (previous Games 29 – 57); Disp. Controller Not Required.





APPENDIX D

Board Type (White Star Board System* Only) Table



Game Name	Flipper	I/O Power Driver	CPU/Sound Stereo	Disp. Power Supply	Dot Matrix Display	Display Controller	OPTO Transmitter	OPTO Receiver	OPTO Application
Apollo 13	520-5080-00 2-Flipper	520-5137-00	520-5136-00	520-5138-00	520-5052-00 128 X 32 Dots	520-5055-01	520-5124-00 Single OPTO	520-5125-00 Single OPTO	5-Ball Trough over Up-Kicker
	Miscellaneous PC Boards:	Light Boards 520-5130-01, -04 & -05 Magnet Interface, 7-Segment Display & Light Bd. 520-5130-06 Magnet Driver Board 520-5130-02 Switch Membrane Board 520-5130-03				Relay Board 520-5010-00			
Golden Eye	520-5080-00 2-Flipper	520-5137-00	520-5136-00	520-5138-00	520-5052-00 128 X 32 Dots	520-5055-01	520-5124-00 Single OPTO	520-5125-00 Single OPTO	5-Ball Trough over Up-Kicker
	Miscellaneous PC Boards:	Light Boards 520-5128-05 through -08		Mag. Processor X2 Driver Bd. 520-5143-00	Relay Board 520-5010-00				

GAMES HEREON NO LONGER REQUIRE THE FLIPPER BOARD WITH THE WHITE STAR BOARD SYSTEM™

Game Name	I/O Power Driver	CPU/Sound Mono	Disp. Power Supply	Dot Matrix Display	Display Controller	OPTO Transmitter	OPTO Receiver	OPTO Application	Misc OPTO & App.
Twister	520-5137-01	520-5136-10	520-5138-00	520-5052-00 128 X 32 Dots	520-5055-01	520-5124-00 Single OPTO	520-5125-00 Single OPTO	5-Ball Trough over Up-Kicker	
	Miscellaneous PC Boards:	Light Boards 520-5145-01 through -07		Mag. Drv. Bd. 520-5143-00	Relay Board 520-5010-00				
Independence Day (ID4)	520-5137-01	520-5136-10	520-5138-00	520-5052-00 128 X 32 Dots	520-5055-01	520-5124-00 Single OPTO	520-5125-00 Single OPTO	4-Ball Trough over Up-Kicker	
	Miscellaneous PC Boards:	Light Boards 520-5149-01 through -10		Servo Mtr. Bd. 520-5152-00		520-5082-00 Long Hop OPTO	520-5083-00 Long Hop OPTO	Alien Head Enter	
Space Jam	520-5137-01	520-5136-10	520-5138-00	520-5052-00 128 X 32 Dots	520-5055-01	520-5124-00 Single OPTO	520-5125-00 Single OPTO	5-Ball Trough over Up-Kicker	
	Miscellaneous PC Boards:	2X 7-Segment Display Board 520-5153-00							
The Star Wars Trilogy - Special Ed.	520-5137-01	520-5136-10	520-5138-00	520-5052-00 128 X 32 Dots	520-5055-01	520-5124-00 Single OPTO	520-5125-00 Single OPTO	4-Ball Trough over Up-Kicker	
	Miscellaneous PC Boards:	Relay Board 520-5010-00							
The Lost World: J.P.	520-5137-01	520-5136-10	520-5138-00	520-5052-00 128 X 32 Dots	520-5055-01	520-5124-00 Single OPTO	520-5125-00 Single OPTO	4-Ball Trough over Up-Kicker	520-5162-00 2-Pos. Motor Sensor on Snagger Motor
	Miscellaneous PC Boards:	DC Relay Bd. 520-5066-00	Shaker Mtr. Bd. 520-5065-00						
The X-Files	520-5137-01	520-5136-10	520-5138-00	520-5052-00 128 X 32 Dots	520-5055-01	520-5124-00 Single OPTO	520-5125-00 Single OPTO	4-Ball Trough over Up-Kicker	520-5155-00 3-Pos. Motor Sensor on File Cab. Motor
	Miscellaneous PC Boards:					520-5082-00 Long Hop OPTO	520-5083-00 Long Hop OPTO	File Cabinet Enter	
Starship Troopers	520-5137-01	520-5136-15	520-5138-00	520-5052-00 128 X 32 Dots	520-5055-02	520-5124-00 Single OPTO	520-5125-00 Single OPTO	4-Ball Trough over Up-Kicker	
	Miscellaneous PC Boards:	4X 7-Segment Display Board 520-5166-00					520-5082-00 Long Hop OPTO	520-5083-01 Long Hop OPTO	L/R Orbit Lane Enter
Viper Night Drivin'	520-5137-01	520-5136-16	520-5138-00	520-5052-00 128 X 32 Dots	520-5055-03	520-5124-00 Single OPTO	520-5125-00 Single OPTO	4-Ball Trough over Up-Kicker	
	Miscellaneous PC Boards:	Relay Board 520-5010-00					520-5082-00 Long Hop OPTO	520-5083-01 Long Hop OPTO	Jump Ramp
Lost In Space	520-5137-01	520-5136-16	520-5138-00	520-5052-00 128 X 32 Dots	520-5055-03	515-0173-00 Dual OPTO	515-0174-00 Dual OPTO	4-Ball Trough over Up-Kicker	
	Miscellaneous PC Boards:	Relay Board 520-5010-00							
Godzilla	520-5137-01	520-5136-16	520-5138-00	520-5052-00 128 X 32 Dots	520-5055-03	515-0173-00 Dual OPTO	515-0174-00 Dual OPTO	4-Ball Trough over Up-Kicker	
	Miscellaneous PC Boards:	Shaker Mtr. Bd. 520-5065-00							
South Park	520-5137-01	520-5136-16	520-5138-00	520-5052-00 128 X 32 Dots	520-5055-03	515-0173-00 Dual OPTO	515-0174-00 Dual OPTO	5-Ball Trough over Up-Kicker	
	Miscellaneous PC Boards:					520-5082-00 Long Hop OPTO	520-5083-01 Long Hop OPTO	Kenny Under Trough Enter	
Harley-Davidson® 1st-3rd* Editions	520-5137-01	520-5136-16 *520-5300-00*	520-5138-00	520-5052-00 128 X 32 Dots	520-5055-03	515-0173-00 Dual OPTO	515-0174-00 Dual OPTO	4-Ball Trough over Up-Kicker	
	Miscellaneous PC Boards:	Relay Board 520-5010-00		Shaker Mtr. Bd. 520-5065-00	Diode Board 520-5146-00		520-5082-00 Long Hop OPTO	520-5083-01 Long Hop OPTO	Motorcycle Enter
Striker Xtreme (NFL)	520-5137-01	520-5136-16	520-5138-00	520-5052-00 128 X 32 Dots	520-5055-03	515-0173-00 Dual OPTO	515-0174-00 Dual OPTO	4-Ball Trough over Up-Kicker	520-5155-00 3-Pos. Motor Sensor on Goalie Motor
	Miscellaneous PC Boards:	DC Relay Bd. 520-5066-00	Relay Board 520-5010-00	Diode Board 520-5146-00	for UK ONLY- Solenoid Expander Bd. 520-5192-00	520-5082-00 Long Hop OPTO	520-5083-01 Long Hop OPTO	Goalie Under- Trough Enter	
Sharkey's Shootout	520-5137-64	520-5136-64	520-5138-00	520-5052-00 128 X 32 Dots	520-5055-03	515-0173-00 Dual OPTO	515-0174-00 Dual OPTO	4-Ball Trough over Up-Kicker	520-5194-00 4-Pos. Motor Sensor on ? -Ball Motor
	Miscellaneous PC Boards:	Relay Board 520-5010-00		Sol. Exp. Bd. 520-5192-00					
High Roller Casino	520-5137-01	520-5136-16	520-5138-00	520-5052-00 128 X 32 Dots	520-5055-03	515-0173-00 Dual OPTO	515-0174-00 Dual OPTO	4-Ball Trough over Up-Kicker	520-5194-00 4-Pos. Motor Sensor on Roulette Wheel Motor
	Miscellaneous PC Boards:	Dot Display (5X7) in Slot Mach. 520-5197-00			for UK ONLY- Solenoid Expander Bd. 520-5192-00		520-5196-00 3-Pos. OPTO	520-5195-00 3-Pos. OPTO	Ball Lock under Roulette Up/Dn Ramp in Slot Mach.
Austin Powers™	520-5137-01	520-5136-16	520-5138-00	520-5052-00 128 X 32 Dots	520-5055-03	515-0173-00 Dual OPTO	515-0174-00 Dual OPTO	4-Ball Trough over Up-Kicker	520-5212-00 Pulse-Stretcher OPTO on Spini-Me
	Miscellaneous PC Boards:	Relay Bd. (X3) 520-5010-00			for UK ONLY- Solenoid Expander Bd. 520-5192-00	520-5082-00 Long Hop OPTO	520-5083-01 Long Hop OPTO	Time Machine Ramp	
MONOPOLY®	520-5137-01	520-5136-16	520-5138-00	520-5052-00 128 X 32 Dots	520-5055-03	515-0173-00 Dual OPTO	515-0174-00 Dual OPTO	4-Ball Trough over Up-Kicker	
	Miscellaneous PC Boards:	DC Relay Bd. 520-5066-00	Mini-Dot Display (3 by 5X7) 520-5197-00 (Electric C- Sign)		for UK ONLY- Solenoid Expander Bd. 520-5192-00	520-5218-00 4-Pos. OPTO	520-5210-00 4-Pos. OPTO	Bank Door	

Table continued on the next page.





APPENDIX D

Board Type (White Star Board System* & S.A.M. System** Only) Table



Game Name	I/O Power Driver	CPU/Sound (old & new)	Disp. Power Supply	Dot Matrix Display	Display Controller	OPTO Transmitter	OPTO Receiver	OPTO Application	Misc OPTO & App.
Playboy	520-5137-01	520-5136-16	520-5138-00	520-5052-00 128 X 32 Dots	520-5055-03	515-0173-00 Dual OPTO	515-0174-00 Dual OPTO	4-Ball Trough over Up-Kicker	
	Miscellaneous PC Boards:	DC Relay Bd. 520-5066-00	Relay Bd. 520-5010-00		for UK ONLY- Solenoid Expander Bd. 520-5192-00				
RollerCoaster Tycoon™	520-5137-01	520-5136-16	520-5138-00	520-5052-00 128 X 32 Dots	520-5055-03	515-0173-00 Dual OPTO	515-0174-00 Dual OPTO	4-Ball Trough over Up-Kicker	520-5222-00 1-Position Switch Detect on Wheel Spin
	Miscellaneous PC Boards:	DC Relay Bd. 520-5066-00	Mini-Dot Display (3 by 5X7) 520-5221-00 (Ramp Enter Sign)		for UK ONLY- Solenoid Expander Bd. 520-5192-00	520-5082-00 Long Hop OPTO	520-5083-01 Long Hop OPTO	Behind 1-Bank Drop Target	
The Simpsons™ Pinball Party	520-5137-01	520-5136-16	520-5138-00	520-5052-00 128 X 32 Dots	520-5055-03	515-0173-00 Dual OPTO	515-0174-00 Dual OPTO	4-Ball Trough over Up-Kicker	
	Miscellaneous PC Boards:	LED Bd. 520-5219-00	Color Dot Display (4 by 5X7) 520-5225-00 (TV Set)		for UK ONLY ◀◀◀ Aux. Driver Bd. 520-5068-01				
Terminator® 3: Rise of the Machines™	520-5137-01	520-5136-16	520-5138-00	520-5052-00 128 X 32 Dots	520-5055-03	515-0173-00 Dual OPTO	515-0174-00 Dual OPTO	4-Ball Trough over Up-Kicker	
	Miscellaneous PC Boards:				for UK ONLY ◀◀◀ Aux. Driver Bd. 520-5068-01	515-7307-00 Single OPTO	515-7308-00 Single OPTO	TXCannon Trough	
The Lord of the Rings™	520-5137-01	New 520-5300-00	520-5138-00	520-5052-00 128 X 32 Dots	520-5055-03	515-0173-00 Dual OPTO	515-0174-00 Dual OPTO	4-Ball Trough over Up-Kicker	500-6746-00 (White Trans.) 500-6747-00 (Black Rec.)
	Miscellaneous PC Boards:	19-LED PCB 520-5242-00	OPTO Transmitter / Receiver Amplifier PCB 520-5239-00		for UK ONLY ◀◀◀ Aux. Driver Bd. 520-5068-01	515-7307-00 Single OPTO	515-7308-00 Single OPTO	Orthanc Tower Trough	
Ripley's Believe It or Not!®	520-5137-01	520-5300-00	520-5138-00	520-5052-00 128 X 32 Dots	520-5055-03	515-0173-00 Dual OPTO	515-0174-00 Dual OPTO	4-Ball Trough over Up-Kicker	500-6775-00 OPTO Trnscvr
	Miscellaneous PC Boards:	520-5236-00 X3 Dot Display	OPTO Transmitter / Receiver Amplifier PCB 520-5239-01		for UK ONLY ◀◀◀ Aux. Driver Bd. 520-5068-01	520-5234-00 3-Pos. OPTO	520-5234-00 3-Pos. OPTO	Vari-Target	520-5235-03 X3 Aux. Drvr
Elvis®	520-5137-01	520-5300-00	520-5138-00	520-5052-00 128 X 32 Dots	520-5055-03	515-0173-00 Dual OPTO	515-0174-00 Dual OPTO	4-Ball Trough over Up-Kicker	
	Miscellaneous PC Boards:				for UK ONLY ◀◀◀ Aux. Driver Bd. 520-5068-01				
The Sopranos™	520-5137-01	520-5300-00	520-5138-00	520-5052-00 128 X 32 Dots	520-5055-03	515-0173-00 Dual OPTO	515-0174-00 Dual OPTO	4-Ball Trough over Up-Kicker	
	Miscellaneous PC Boards:				for UK ONLY ◀◀◀ Aux. Driver Bd. 520-5068-01				
NASCAR® and [NDSE]	520-5137-01	520-5300-00	520-5138-00	520-5052-00 128 X 32 Dots	520-5055-03	515-0173-00 Dual OPTO	515-0174-00 Dual OPTO	4-Ball Trough over Up-Kicker	500-6775-00 OPTO Trans. (Qty. 16) Switch Detect.
	Miscellaneous PC Boards:	520-5235-03 X3 Aux. Drvr	OPTO Transmitter / Receiver Amplifier PCB 520-5239-01		for UK ONLY ◀◀◀ Aux. Driver Bd. 520-5068-01				
Grand Prix	520-5137-01	520-5300-00	520-5138-00	520-5052-00 128 X 32 Dots	520-5055-03	515-0173-00 Dual OPTO	515-0174-00 Dual OPTO	4-Ball Trough over Up-Kicker	500-6775-00 OPTO Trans. (Qty. 16) Switch Detect.
	Miscellaneous PC Boards:	520-5235-03 X3 Aux. Drvr	OPTO Transmitter / Receiver Amplifier PCB 520-5239-01		for UK ONLY ◀◀◀ Aux. Driver Bd. 520-5068-01				

Game Name	I/O Power Driver**	CPU / Sound**	Disp. Power Supply	Dot Matrix Display	Dual OPTO Transmitter	Dual OPTO Receiver	Dual OPTO Transceiver	OPTO Transceiver Miscellaneous
World Poker Tour™ (WPT)	520-5249-00 Backbox	520-5246-00 Backbox	520-5138-00 Backbox	520-5052-00 128 X 32 Dots	515-0173-00 4-Ball Trough	515-0174-00 4-Ball Trough	500-6775-00 4 Switch Pairs (Qty. 8)	520-5251-00 'U' 1/per PCB Jail Bars Up Ace/Hole Mech 520-5252-04 'U' 4/per PCB Drop Targets 4- & 8- Banks
	Miscellaneous PCBs:	520-5254-00 50V Step-Up Drv	520-5250-14 14LED 5X7 Disp.	520-5239-01 OPTO Amplifier	520-5247-00 Ace/Hole Mech	520-5248-00 Ace/Hole Mech		
The Simpsons™ Kooky Carnival	520-5249-00 Back Door	520-5246-00 Back Door	520-5138-00 Cabinet Rear	520-5052-00 128 X 32 Dots			520-5253-00-ASY Coin Drop (Qty. 11)	
	Miscellaneous PCBs:	515-5742-00 Shaker PCB	500-6700-00 Relay (incl. Wiring + Conn.)					
©Disney's Pirates of the Caribbean	520-5249-00 Backbox	520-5246-00 Backbox	520-5138-00 Backbox	520-5052-00 128 X 32 Dots	515-0173-00 4-Ball Trough	515-0174-00 4-Ball Trough	500-6775-00 5 Switch Pairs (Qty. 10)	
	Miscellaneous PCBs:	520-5239-01 OPTO Amp. (X3)	511-5024-03 Relay (incl. Wiring + Conn.)	520-5238-00 : H-E-A-R-T LED PCB				
Family Guy™	520-5249-00 Backbox	520-5246-00 Backbox	520-5138-00 Backbox	520-5052-00 128 X 32 Dots	515-0173-00 4-Ball Trough	515-0174-00 4-Ball Trough	500-6775-00 3 Switch Pairs (Qty. 6)	520-5252-01 'U' 1/per PCB Drop Target 1-Bank
	Miscellaneous PCBs:	520-5239-01 OPTO Amp. (X2)	520-5261-00 Stepper Motor	511-5042-01 Trgt. Sensor (X2)			500-6775-01 1 Switch Pair (Qty. 2)	520-5252-04 'U' 4/per PCB Drop Target 4-Bank
Spider-Man™	520-5249-00 Backbox	520-5246-00 Backbox	520-5138-00 Backbox	520-5052-00 128 X 32 Dots	515-0173-00 4-Ball Trough	515-0174-00 4-Ball Trough	500-6775-00 3 Switch Pairs (Qty. 6)	
	Miscellaneous PCBs:	520-5239-01 OPTO Amp. (X2)						



APPENDIX D

Board Type Table

Game Name	Flipper	Sound	Power Supply	Display X-Digit
<ul style="list-style-type: none"> Laser War 	2-Flipper Board Not Required	<i>initial:</i> 520-5002-00 <i>replaced with:</i> 520-5002-02 <i>520-5002-01 was not used.</i>	520-5000-00	Master: 520-5004-00 plus: 520-5005-00 (Qty. 2): 7 Digit Alpha/Numeric 520-5006-00 (Qty. 2): 7 Digit Numeric 520-5007-00 (Qty. 1): 4 Digit Numeric
<ul style="list-style-type: none"> Secret Service Torpedo Alley 	3-Flipper Board Not Required	520-5002-02		520-5014-01 7 Digit Alpha/Numeric Combined
<ul style="list-style-type: none"> Time Machine 	2-Flipper Board Not Required			520-5030-00 16 Digit Alpha/Numeric Combined
<ul style="list-style-type: none"> Playboy 35th Anniversary * ABC Monday Night Football * Robocop Phantom of the Opera Back to the Future The Simpsons 	520-5033-00 2-Flipper <i>(*only for 100 games of Playboy 35th Anniv. & ABC Mon. Night Football)</i>			
		520-5002-03		

Game Name	Flipper	Sound	Power Supply	Dot Matrix Display	Display Controller	OPTO Transmitter	OPTO Receiver	OPTO Application
<ul style="list-style-type: none"> Checkpoint Teenage Mutant Ninja Turtles 	520-5033-00 2-Flipper	520-5002-03	520-5047-00	520-5042-00 128 X 16	520-5055-00			
<ul style="list-style-type: none"> Batman Star Trek 25th Anniv. Hook 		520-5050-01						
<ul style="list-style-type: none"> Lethal Weapon 3 		520-5050-02	520-5047-01					
<ul style="list-style-type: none"> Star Wars Rocky & Bullwinkle & Friends 			520-5047-02	520-5052-00 128 X 32				
<ul style="list-style-type: none"> Jurassic Park 		520-5076-00 3-Flipper						
<ul style="list-style-type: none"> Last Action Hero 		520-5070-00 2-Flipper	520-5077-00					
<ul style="list-style-type: none"> Tales from the Crypt 		520-5076-00 3-Flipper						
<ul style="list-style-type: none"> WWF Royal Rumble 		520-5070 / 5080 -00 4-Flipper (2X2)	520-5126-02					
<ul style="list-style-type: none"> Guns N' Roses 		520-5076-00 3-Flipper						
<ul style="list-style-type: none"> Maverick 		520-5076-00 3-Flipper	520-5092-01	520-5102-00 Single OPTO				
<ul style="list-style-type: none"> Mary Shelley's Frankenstein 	520-5076-00 3-Flipper	520-5124-00 Single OPTO		520-5125-00 Single OPTO	5-Ball Trough over Up-Kicker			
<ul style="list-style-type: none"> Baywatch 	520-5070 / 5080 -00 4-Flipper (2X2)	520-5124-00 Single OPTO	520-5125-00 Single OPTO	4-Ball Trough over Up-Kicker				
<ul style="list-style-type: none"> Batman Forever 	520-5076-00 3-Flipper							

Miscellaneous Boards (Lamp Boards & Relay Boards) not listed above can be found in each individual game manual.





APPENDIX E

Flipper Coil (White Star Board System* & S.A.M. System** Only) Table



Typical Coil Diode 1N4004 unless noted otherwise (Diode Top = above lugs next to windings; Diode Below (Bottom) = under lugs opposite of windings).

STANDARD COILS (TYPICAL APPLICATIONS)			LARGE COILS (FLIPPERS & SPECIAL APPLICATIONS)		
Ga.-Turn	Res (Ω)	SPI Part Number and Comments	Ga.-Turn	Res (Ω)	SPI Part Number and Comments
20-400	1.0 Ω	090-5021-use: -00 Diode Top	21-900	call Ω	090-5020-use: -01 3-Lugs + 1N4004 & 1N5404 Diodes -10 Diode Top <BROWN><RED>
22-500	1.7 Ω	090-5017-use: -00 Diode Top	22-750 / 30-2600	2.6 Ω 92.0 Ω	090-5011-use: -00 DUAL WND COIL // 3-Lugs Diode x2
22-600	2.2 Ω	090-5017-use: -0B Diode Below // -0T Diode Top			
23-700	3.1 Ω	090-5022-use: -0B Diode Below // -0T Diode Top	22-900	3.45 Ω	090-5020-use: -20T Diode Top <YELLOW> // -20-ND No Diode
23-750	3.4 Ω	090-5019-use: -00 Diode Top			
23-800	3.6 Ω	090-5001-use: -0B Diode Below // -0T Diode Top // -NL No Lugs 11" Leads // -ND No Diode	22-1080	4.2 Ω	090-5032-use: -0B D. Below // -0T D. Top <YEL-GRN> -NL No Diode
23-840	4.0 Ω	090-5005-use: -00 Diode Top			
23.5-765	3.6 Ω	090-5037-use: -03 Diode Top	23-620 / 30-2600	2.4 Ω 75.0 Ω	090-5006-use: -00 DUAL WND COIL // 3-Lugs Diode x2
24-900	5.0 Ω	090-5002-use: -02 Diode Top // -10 No Lugs 14" Leads			
24-940	5.5 Ω	090-5036-use: -0B Diode Below // -0T Diode Top use 090-5051-01 No Lugs 11" Leads	23-700 / 30-2600	3.0 Ω 83.5 Ω	090-5013-use: -00 DUAL WOUND COIL // Diode Top
25-1240	9.3 Ω	090-5034-use: -00 Diode Below			
26-1200	10.3 Ω	090-5044-use: -0B Diode Below // -0T Diode Top // -NL No Lugs 11" Leads // -ND No Diode	23-800 / 30-2600	2.4 Ω 90.5 Ω	090-5012-use: -00 DUAL WOUND COIL // Diode Top
27-1300	14.2 Ω	090-5003-use: -0T Diode Top			
27-1400	14.7 Ω	090-5015-use: -00 Diode Below	23-1100	5.1 Ω	090-5030-use: -0T Diode Top <ORANGE> -ND No Diode
27-1400	14.7 Ω	511-5031-00 Special App.: No Diode / Lugs + Conn.			
27-1500	16.3 Ω	090-5004-use: -0B Diode Below // -0T Diode Top	23-1200	7.1 Ω	090-5008-use: -00 Diode Top <BLACK>
29-2000	33.6 Ω	090-5016-use: -00 Diode Top	23-1500	4.4 Ω	090-5062-use: -00 Diode Top <BLUE>
LARGE, MEDIUM & MINI COILS (MAGNET APPLICATIONS)			24-1570	9.5 Ω	090-5025-use: -00 Diode Top <BLUE>
20.5-480	2.9 Ω	090-5064-use: -02 No Lugs or Core; 14" Leads // Large	25-1400	call Ω	090-5067-use: -0T Diode Top <RED>
22-650	4.3 Ω	090-5042-use: -00 No Lugs or Core; 6" Leads // Large -01 No Lugs or Core; 12" Leads // Large	25-1600	call Ω	090-5068-use: -0T Diode Top <WHITE>
24-780	8.0 Ω	090-5061-use: -00 No Lugs or Core; 6" Lds. // Medium	MINI COILS (RESET / TRIP APPLICATIONS)		
29-1000	15.2 Ω	090-5059-use: -00 Lugs + Diode + Magnet Core // Mini	27-950	call Ω	090-5046-use: -01 Diode Top
31-1500	52.0 Ω	090-5054-00: Straight Lugs + Diode + Mag Core // Mini 090-5055-00: 90° Lugs + Diode + Magnet Core // Mini	28-1050	11.5 Ω	090-5046-use: -00 Diode Top
Please Note: Ohm values may vary +/- .03 depending on meter calibration.			27-880	call Ω	500-6976-01 No Lugs or Diode + 6" Leads & Conn.
Ordering Note: Coils typically should not come with Coil Sleeves. IF A SLEEVE EXISTS, ensure it is the correct sleeve for the application usage. For the correct Coil Sleeve, refer to the Game Assembly Drawing the coil exists on and order separately.			31-590	call Ω	090-5010-use: -00 Diode Top
			32-1250	35.0 Ω	515-6916-01: includes Flap & Screw <YELLOW>
			32-1800	50.2 Ω	090-5031-use: -0B Diode Below // -0T Diode Top (515-6110-00) use 515-# to include mounting & armature brackets
			33-1590	59.0 Ω	515-6916-00: includes brackets <WHITE>

Flipper Coil (White Star Board System* Only) Table

GAME NAME	Nº of Flippers	FLIPPERS		FLIPPERS no E.O.S. Switch	
		SPI Nº / GAUGE-TURNS / Color		SPI Nº / GAUGE-TURNS / Color	
		LOWER LEFT	LOWER RIGHT	UPPER LEFT	UPPER RIGHT
Apollo 13	2	090-5032-0T 22-1080 -YEL-GRN-	SAME	Not Used	Not Used
Golden Eye	2	090-5032-0T 22-1080 -YEL-GRN-	SAME	Not Used	Not Used
Twister	2	090-5020-20T 22-900 -YELLOW-	090-5032-0T 22-1080 -YEL-GRN-	Not Used	Not Used
ID4: Independence Day	3	090-5032-0T 22-1080 -YEL-GRN-	SAME	Not Used	090-5020-30 23-900 -GREEN-
Space Jam †	2	090-5032-0T 22-1080 -YEL-GRN-	090-5020-20T 22-900 -YELLOW-	Not Used	Not Used
The Star Wars Trilogy - Special Edition †	2	090-5032-0T 22-1080 -YEL-GRN-	SAME	Not Used	Not Used
The Lost World: Jurassic Park †	2	090-5032-0T 22-1080 -YEL-GRN-	SAME	Not Used	Not Used
The X-Files †	2	090-5032-0T 22-1080 -YEL-GRN-	SAME	Not Used	Not Used
Starship Troopers †	3	090-5030-0T 23-1100 -ORANGE-	SAME	Not Used	090-5032-0T 22-1080 -YEL-GRN-
Viper Night Drivin' †	2	090-5030-0T 23-1100 -ORANGE-	SAME	Not Used	Not Used
Lost In Space †	2	090-5030-0T 23-1100 -ORANGE-	090-5032-0T 22-1080 -YEL-GRN-	Not Used	Not Used
Godzilla †	2	090-5032-0T 22-1080 -YEL-GRN-	SAME	Not Used	Not Used
South Park †	2	090-5030-0T 23-1100 -ORANGE-	SAME	Not Used	Not Used

† Coil Part Numbers ending with a "T" signifies the Diode is on the top of the lug (on the coil-winding side); Coil Part Numbers ending with a "B" signifies the Diode is on the bottom of the lugs.

Table continued on the next page.





APPENDIX E

Flipper Coil (White Star Board System* & S.A.M. System** Only) Table



GAME NAME	N ^o of Flippers	FLIPPERS w/E.O.S. Switch		FLIPPERS no E.O.S. Switch	
		SPI N ^o / GAUGE-TURNS / Color		SPI N ^o / GAUGE-TURNS / Color	
		LOWER LEFT	LOWER RIGHT	UPPER LEFT	UPPER RIGHT
Harley-Davidson® † and 1st through 3rd Editions	2	090-5032-0T 22-1080 -YEL-GRN-	090-5030-0T 23-1100 -ORANGE-	Not Used	Not Used
Striker Xtreme (NFL) †	3	090-5032-0T 22-1080 -YEL-GRN-	090-5030-0T 23-1100 -ORANGE-	090-5030-0T 23-1100 -ORANGE-	Not Used
Sharkey's Shootout †	3	090-5030-0T 23-1100 -ORANGE-	SAME	090-5030-0T 23-1100 -ORANGE-	Not Used
High Roller Casino †	2	090-5032-20T 22-900 -YELLOW-	090-5032-0T 22-1080 -YEL-GRN-	Not Used	Not Used
Austin Powers™ †	2	090-5020-30 23-900 -GREEN-	090-5030-0T 23-1100 -ORANGE-	Not Used	Not Used
MONOPOLY® †	3	090-5032-0T 22-1080 -YEL-GRN-	SAME	Not Used	090-5062-0T 23-1500 -BLUE-
Playboy †	2	090-5030-0T 23-1100 -ORANGE-	SAME	Not Used	Not Used
RollerCoaster Tycoon™ †	4	090-5032-0T 22-1080 -YEL-GRN-	SAME	090-5067-0T 25-1400 -RED-	090-5068-0T 25-1600 -WHITE-
The Simpsons™ Pinball Party †	6** (5 with Flipper Bats)	090-5032-0T 22-1080 -YEL-GRN-	SAME	Not Used	090-5030-0T 23-1100 -ORANGE-
		** The Homer Head Assembly is affixed to an Upr. Rt. Style Flipper (no E.O.S. Switch):		Flippers (Mini-Bats) on 2nd Level Playfield:	
			** 090-5020-20T 22-900 -YELLOW-	090-5041-00T 25-1800 -BLU-GRN-	090-5025-00 24-1570 -BLUE-
Terminator® 3: Rise of the Machines™ †	2	090-5032-0T 22-1080 -YEL-GRN-	SAME	Not Used	Not Used
The Lord of the Rings™ †	2	090-5020-20T 22-900 -YELLOW-	SAME	Not Used	Not Used
Ripley's Believe It or Not!® †	3	090-5032-0T 22-1080 -YEL-GRN-	SAME	Not Used	090-5067-00T 25-1400 -RED-
Elvis® †	4	090-5020-20T 22-900 -YELLOW-	SAME	090-5020-30 23-900 -GREEN-	SAME
The Sopranos™ †	2	090-5032-0T 22-1080 -YEL-GRN-	SAME	Not Used	Not Used
NASCAR® and [NDSE] †	2	090-5030-0T 23-1100 -ORANGE-	SAME	Not Used	Not Used
Grand Prix †	2	090-5030-0T 23-1100 -ORANGE-	SAME	Not Used	Not Used
† Coil Part Numbers ending with a "T" signifies the Diode is on the top of the lug (on the coil-winding side); Coil Part Numbers ending with a "B" signifies the Diode is on the bottom of the lugs.					
** S.A.M. System Games DO NOT REQUIRE DIODES. If you use a coil from your stock which has a diode, remove it ONLY FOR S.A.M. System Games.					
World Poker Tour™ (WPT)**	4	090-5032-ND 22-1080 [NO DIODE]	SAME	090-5030-ND 23-1100 [NO DIODE]	SAME
©Disney's Pirates of the Caribbean**	2	090-5030-ND 23-1100 [NO DIODE]	SAME	Not Used	Not Used
Family Guy™ **	3 Norm.	090-5030-ND 23-1100 [NO DIODE]	SAME	090-5062-ND 23-1500 [NO DIODE]	Not Used
	2 Mini	090-5046-01-ND 27-950 [NO DIODE]	SAME		
Spider-Man™ **	3	090-5032-ND 22-1080 [NO DIODE]	SAME	Not Used	090-5032-ND 22-1080 [NO DIODE]



APPENDIX E

Generic Coil Cross-Reference Guide † ‡

Flipper Coil Table ‡ ††

GAME NAME	Nº of Flippers	FLIPPERS w/E.O.S. Switch		FLIPPERS no E.O.S. Switch	
		SPI Nº / GAUGE-TURNS / Color		SPI Nº / GAUGE-TURNS / Color	
		LOWER LEFT	LOWER RIGHT	UPPER LEFT	UPPER RIGHT
Laser War ‡	2	090-5011-00 22-750 / 30-2600	SAME	Not Used	Not Used
Secret Service ‡	3	090-5006-00 23-620 / 30-2600	SAME	Not Used	090-5006-00 23-620 / 30-2600
Torpedo Alley ‡	3	090-5011-00 22-750 / 30-2600	090-5013-00 23-700 / 30-2600	Not Used	090-5012-00 23-800 / 30-2600
Time Machine ‡	2	090-5011-00 22-750 / 30-2600	SAME	Not Used	Not Used
‡ These coils are dual-wound.					
Playboy 35th Anniversary ††	2	090-5020-02 22-900 -YEL-YEL-	SAME	Not Used	Not Used
ABC Monday Night Football ††	2	090-5020-02 22-900 -YEL-YEL-	SAME	Not Used	Not Used
†† A very small % of these games used a 090-5020-20 coil which used a proto-type Solid State Flipper System. The two types of coils both are 22-900 coils; the only difference is the addition of the 1N5404 Diode on the (-02) coils which was used in the Deger Design.					
Robocop	2	090-5020-20 22-900 -YEL-YEL-	SAME	Not Used	Not Used
Phantom of the Opera	2	090-5020-20 22-900 -YEL-YEL-	SAME	Not Used	Not Used
Back to the Future	2	090-5020-20 22-900 -YEL-YEL-	SAME	Not Used	Not Used
The Simpsons	2	090-5020-20 22-900 -YEL-YEL-	SAME	Not Used	Not Used
Checkpoint	2	090-5020-20 22-900 -YEL-YEL-	SAME	Not Used	Not Used
Teenage Mutant Ninja Turtles	2	090-5020-30 23-900 -GRN-GRN-	SAME	Not Used	Not Used
Batman	2	090-5020-30 23-900 -GRN-GRN-	SAME	Not Used	Not Used
Star Trek 25th Anniversary	2	090-5020-30 23-900 -GRN-GRN-	SAME	Not Used	Not Used
Hook	2	090-5030-00 23-1100 -ORG-ORG-	090-5020-30 23-900 -GRN-GRN-	Not Used	Not Used
Lethal Weapon 3	2	090-5030-00 23-1100 -ORG-ORG-	SAME	Not Used	Not Used
Star Wars	2	090-5032-00 22-1080 -YEL-GRN-	SAME	Not Used	Not Used
Rocky & Bullwinkle & Friends	2	090-5020-30 23-900 -GRN-GRN-	SAME	Not Used	Not Used
Jurassic Park	3	090-5020-30 23-900 -GRN-GRN-	SAME	Not Used	090-5030-00 23-1100 -ORG-ORG-

Table continued on the next page.



APPENDIX E

Flipper Coil Table †

GAME NAME	N ^o of Flippers	FLIPPERS w/ E.O.S. Switch		FLIPPERS no E.O.S. Switch	
		SPI N ^o / GAUGE-TURNS / Color		SPI N ^o / GAUGE-TURNS / Color	
		LOWER LEFT	LOWER RIGHT	UPPER LEFT	UPPER RIGHT
Last Action Hero	2	090-5020-30 23-900 -GRN-GRN-	SAME	Not Used	Not Used
Tales from the Crypt	3	090-5032-00 22-1080 -YEL-GRN-	SAME	Not Used	090-5041-00 25-1800 -BLU-GRN-
The Who's Tommy	3	090-5020-30 23-900 -GRN-GRN-	SAME	090-5041-00 25-1800 -BLU-GRN-	Not Used
WWF Royal Rumble	4	090-5032-00 22-1080 -YEL-GRN-	SAME	090-5041-00 25-1800 -BLU-GRN-	SAME
Guns N' Roses	3	090-5032-00 22-1080 -YEL-GRN-	SAME	090-5030-00 23-1100 -ORG-ORG-	Not Used
Maverick	3	090-5032-00 22-1080 -YEL-GRN-	SAME	Not Used	090-5032-00 22-1080 -YEL-GRN-
Mary Shelley's Frankenstein	3	090-5030-00 23-1100 -ORG-ORG-	SAME	Not Used	090-5030-00 23-1100 -ORG-ORG-
Baywatch	4	090-5030-00 23-1100 -ORG-ORG-	090-5020-30 23-900 -GRN-GRN-	090-5025-00 24-1570 -See Note-	090-5030-00 23-1100 -ORG-ORG-
Batman Forever	3	090-5032-00 22-1080 -YEL-GRN-	090-5020-20 22-900 -YEL-YEL-	Not Used	090-5020-30 23-900 -GRN-GRN-
Apollo 13	2	090-5032-00 22-1080 -YEL-GRN-	SAME	Not Used	Not Used
Golden Eye	2	090-5032-00 22-1080 -YEL-GRN-	SAME	Not Used	Not Used
Twister	2	090-5020-20 22-900 -YEL-YEL-	090-5032-00 22-1080 -YEL-GRN-	Not Used	Not Used
ID4: Independence Day	3	090-5032-00 22-1080 -YEL-GRN-	SAME	Not Used	090-5020-30 23-900 -GRN-GRN-
Space Jam †	2	090-5032-00T 22-1080 -YEL-GRN-	090-5020-20T 22-900 -YEL-YEL-	Not Used	Not Used
The Star Wars Trilogy - Special Edition †	2	090-5032-00T 22-1080 -YEL-GRN-	SAME	Not Used	Not Used
The Lost World: Jurassic Park †	2	090-5032-00T 22-1080 -YEL-GRN-	SAME	Not Used	Not Used
The X-Files †	2	090-5032-00T 22-1080 -YEL-GRN-	SAME	Not Used	Not Used
Starship Troopers †	3	090-5030-00T 23-1100 -ORG-ORG-	SAME	Not Used	090-5032-00T 22-1080 -YEL-GRN-
Viper Night Drivin' †	2	090-5030-00T 23-1100 -ORG-ORG-	SAME	Not Used	Not Used
Lost In Space †	2	090-5030-00T 23-1100 -ORG-ORG-	090-5032-00T 22-1080 -YEL-GRN-	Not Used	Not Used
Godzilla †	2	090-5032-00T 22-1080 -YEL-GRN-	SAME	Not Used	Not Used
South Park †	2	090-5030-00T 23-1100 -ORG-ORG-	SAME	Not Used	Not Used
Harley-Davidson® † and Harley-Davidson® 2nd Ed. †	2	090-5032-00T 22-1080 -YEL-GRN-	090-5030-00T 23-1100 -ORG-ORG-	Not Used	Not Used
Striker Xtreme (NFL) †	3	090-5032-00T 22-1080 -YEL-GRN-	090-5030-00T 23-1100 -ORG-ORG-	090-5030-00T 23-1100 -ORG-ORG-	Not Used
Sharkey's Shootout †	3	090-5030-00T 23-1100 -ORG-ORG-	SAME	090-5030-00T 23-1100 -ORG-ORG-	Not Used
High Roller Casino †	2	090-5020-20T 22-900 -YEL-YEL-	090-5032-00T 23-1080 -YEL-GRN-	Not Used	Not Used
Austin Powers™ †	2	090-5020-30 23-900 -GRN-GRN-	090-5030-00T 23-1100 -ORG-ORG-	Not Used	Not Used
MONOPOLY® †	3	090-5032-00T 22-1080 -YEL-GRN-	SAME	Not Used	090-5062-00T 23-1500 -BLU-BLU-
Playboy †	2	090-5030-00T 23-1100 -ORG-ORG-	SAME	Not Used	Not Used
RollerCoaster Tycoon™ †	4	090-5032-00T 22-1080 -YEL-GRN-	SAME	090-5067-00T 25-1400 -RED-RED-	090-5068-00T 25-1600 -WHT-WHT
The Simpsons™ Pinball Party †	6* (5 with Flipper Bats)	090-5032-00T 22-1080 -YEL-GRN-	SAME	Not Used	090-5030-00T 23-1100 -ORG-ORG-
		* The Homer Head Assembly is affixed to an Upr. Rt. Style Flipper (no E.O.S. Switch):		Flippers (Mini-Bats) on 2nd Level Playfield:	
			* 090-5020-20T 22-900 -YEL-YEL-	090-5041-00T 25-1800 -BLU-GRN-	090-5025-00T 24-1570 -See Note-
Terminator® 3: Rise of the Machines™ †	2	090-5032-00T 22-1080 -YEL-GRN-	SAME	Not Used	Not Used
The Lord of the Rings™ †	2	090-5020-20T 22-900 -YEL-YEL-	SAME	Not Used	Not Used
Ripley's Believe It or Not!® †	3	090-5032-00T 22-1080 -YEL-GRN-	SAME	Not Used	090-5067-00T 25-1400 -RED-RED-

† Coil Part N^os ending with a "T" signifies the Diode is on the top of the lug (on the coil-winding side); Coil Part N^os ending with a "B" signifies the Diode is on the bottom of the lugs.



APPENDIX F

Motor Specification (White Star Board System* Only) Table



Game Name	Function	Specifications	Part Number
Apollo 13	Rocket Up/Down Movement	Bowman Motor 24VAC 60Hz 3W 6 RPM CCW	515-6383-00 <i>incl. Connector</i>
	Moon Unit Rotational Orbit	Multi Products Motor 24VAC 50/60Hz 3W 6 RPM CCW	515-6487-00 <i>incl. Connector</i>
	Shaker	Johnson Motor (Vibrator) 10.5VDC 10 AMP 2950 RPM CW	041-5029-00 MOTOR ONLY
Golden Eye	Satellite Left/Right Movement	Bowman Motor 24VAC 60Hz 3W 6 RPM CW	515-6528-00 <i>incl. Connector</i>
Twister	Spinning Disc with Magnet	Multi Products Motor 24VAC (041-5026-00) 50/60Hz 3W 325 RPM CCW	515-6347-00 <i>incl. Connector</i>
	Backbox Fan (Tornado Wind)	Multi Products Motor 24VAC (041-5052-00) 50/60Hz 3W 3600 RPM CW	515-6531-00 <i>incl. Connector</i>
ID4: Independence Day	Alien Head Open/Close Movement	Servo Motor (94322)	041-5045-00 MOTOR ONLY
<i>SPACE JAM (NO MOTOR USED)</i>			
The Star Wars Trilogy - S.E.	X-Wing Left/Right Movement	Bowman Motor 24VAC (041-5058-00) 60Hz 3W 10 RPM CCW	515-6383-01 <i>incl. Connector</i>
The Lost World: Jurassic Park	Snagger & Center Link Lift Up/Down Movement	Multi Products Motor 20VDC (041-5059-03) 9 RPM Non-Directional	515-6715-03 <i>incl. Connector</i>
	Shaker	Johnson Motor (Vibrator) 10.5VDC 10 AMP 2950 RPM CW	041-5029-00 MOTOR ONLY
The X-Files	X-File Cabinet Lift Up/Down Movement	Multi Products Motor 20VDC 9 RPM CCW	041-5057-00 MOTOR ONLY
Starship Troopers	Warrior Bug Forward/Reverse Movement	Haydon Switch & Instrument, Inc. Stepper Motor 12VDC 4.6W (041-5062-00), Series 36000: 1.4"ø (Non-Captive Shaft not included) HSI #36864-12 (Unipolar) Travel per Step: .004 Step Angle: 15°	515-6794-00 <i>incl. Connector</i> Requires 7" Shaft: 530-5503-00
<i>VIPER NIGHT DRIVIN' (NO MOTOR USED)</i>			
Lost In Space	Spinning Disc with Magnet	Multi Products Motor 24VAC (041-5046-00) 50/60Hz 3W 325 RPM CCW	515-6347-00 <i>incl. Connector</i>
Godzilla	Shaker ‡	Multi #3811 0630 Motor (Vibrator) 12VDC 3100 RPM CW (w/DRL PTS) ‡	041-5029-01 MOTOR ONLY
<i>SOUTH PARK (NO MOTOR USED)</i>			
Harley-Davidson® 1st through 3rd Editions	Shaker ‡	Multi #3811 0630 Motor (Vibrator) 12VDC 3100 RPM CW (w/DRL PTS) ‡	041-5029-01 MOTOR ONLY
	Motorcycle Lift Up/Down Movement	Autotrol 24VAC (041-5072-02) 20 RPM CCW	515-7025-00 <i>incl. Connector</i>
Striker Xtreme (NFL)	Goalie (Linebacker) Left to Right Movement	Multi #3590 12VDC (041-5075-00) 60 RPM	515-7071-00 <i>incl. Connector</i>
Sharkey's Shootout	Mystery Ball Rotating Movement	Hankscraft Motor Model-E 24VAC (041-5076-00) 50/60Hz 3W 20 RPM CW	515-7095-00 <i>incl. Connector</i>
High Roller Casino	Roulette Wheel Rotating Movement	Multi Products Motor 20VDC (041-5078-00) 17 RPM CCW	515-7153-00 <i>incl. Connector</i>
	Up/Dn. Ramp in Slot Mach. Lift Up/Down Movement	Haydon Switch & Instrument, Inc. Stepper Motor 12VDC 4.6W (041-5062-00), Series 36000: 1.4"ø (Non-Captive Shaft not included) HSI #36864-12 (Unipolar) Travel per Step: .004 Step Angle: 15°	515-6794-00 <i>incl. Connector</i> Requires Shaft ¾": 530-5503-01
Austin Powers™	Time Machine Rotating Movement	Multi Products Motor 24VAC (041-5079-00) 50/60Hz 20RPM CCW	515-7141-00 <i>incl. Connector</i>
	Laser Beam Left to Right Directional	Autotrol Motor 24VAC (041-5081-00) 50/60Hz 4W 10RPM Bi-Directional	515-7171-00 <i>incl. Connector</i>
	Dr. Evil Target Lift Up/Down Movement	Hankscraft Motor Model-E 24VAC (041-5030-00) 50/60Hz 6RPM CCW	515-5900-00 <i>incl. Connector</i>
Monopoly®	Mini-Flipper (Waterworks) Rotating Movement	Multi Prod. Motor & Gear Box #7000 EX00159A 20VDC 50/60Hz 85RPM CC/CCW	041-5083-00 MOTOR ONLY
Playboy	Triangular Billboard Rotating Movement	Autotrol Motor (BD511 150-1387) 24VAC 50/60Hz 12RPM Bi-Directional	041-5086-02 MOTOR ONLY
	Centerfold Mechanism Open/Close Movement	Multi Products (3680) Motor 12v DC 10/12 RPM CC/CCW	041-5075-04 MOTOR ONLY
	Tease Drop Screen Lift Up/Down Movement	Haydon Switch & Instrument, Inc. Stepper Motor 12VDC 4.6W (041-5062-00), Series 36000: 1.4"ø (Non-Captive Shaft not included) HSI #36864-12 (Unipolar) Travel per Step: .004 Step Angle: 15°	515-6794-00 <i>incl. Connector</i> Requires 7" Shaft: 530-5503-00

‡ Please Note: ".01" Shaker Motor is **Not Compatible** with old Shaker Motor 041-5029-00 (Shaker Motor Assy. 515-5893-00). THIS NEW MOTOR CAN ONLY BE USED IN NEW SHAKER MOTOR ASSY. 515-5893-01.

Table continued on the next page.





APPENDIX F

Motor Specification (White Star Board System* & S.A.M. System** Only) Table



Game Name	Function	Specifications	Part Number
ROLLERCOASTER TYCOON™ (NO MOTOR USED)			
THE SIMPSONS™ PINBALL PARTY (NO MOTOR USED)			
Terminator® 3: Rise of the Machines™	Backbox Ball Shooter Up/Down Movement	Multi Products Motor 24VAC (041-5079-01) 21 RPM CW	515-7317-00 <i>incl. Connector</i>
The Lord of the Rings™	Balrog (Motor & Gate) Open/Close Movement	Multi Prod. Motor 20VDC Series 600B (or equiv.) 50/60Hz 10 RPM Bi-Directional	041-5088-01 MOTOR ONLY
RIPLEY'S BELIEVE IT OR NOT!® (NO MOTOR USED)			
Elvis®	Elvis™ Front/Back Movement	Haydon Switch & Instrument, Inc. Stepper Motor 12VDC 10W (041-5089-00), (Non-Captive Shaft not included) HSI #46868-12-002	500-6809-00 <i>incl. Connector</i> Requires 7.25" Shaft: 530-5658-00
	▶▶▶ OPTIONAL ◀◀◀ Shaker	Multi #3811 0630 Motor (Vibrator) 12VDC (041-5029-01) 3100 RPM (w/DRL PTS)	515-5893-01 <i>incl. Connector</i>
The Sopranos™	Bada Bing! Girls x2 Rotating Posts Movement	Autotrol Synchronous Motor 24VAC 4W 50/60Hz 45.7/54.9 RPM Bi-Directional	041-5092-00 <i>w/1" Shaft + 12" Leads</i>
NASCAR® and [NDSE]	Back Panel Rotating (Car) Windmill (Skill Ball Enter)	Multi Products Motor & Gear Box 20VDC Model #8000 (EX-04-073) 10 RPM	041-5093-00 MOTOR ONLY
Grand Prix	Back Panel Rotating (Car) Windmill (Skill Ball Enter)	Multi Products Motor & Gear Box 20VDC Model #8000 (EX-04-073) 10 RPM	041-5093-00 MOTOR ONLY
World Poker Tour™ (WPT) (NO MOTOR USED)			
The Simpsons™ Kooky Carnival	Bart on Skateboard Left/Right Movement	Multi Products Motor with Crank 24VAC (041-5095-01) 50/60Hz 3W 14 RPM	500-6947-01 <i>incl. Connector</i>
	Left & Right Ramps Up/Down Movement	Multi Products Motor 24VAC (041-5048-01) 50/60Hz 3W 15 RPM CCW (Qty. 2 in game)	515-7558-00 <i>incl. Connector</i>
	Shaker <i>(details in SKC Manual, Page 24)</i>	Multi #3811 0630 Motor (Vibrator) 12VDC 3100 RPM (w/DRL PTS)	041-5029-01 MOTOR ONLY
©Disney's Pirates of the Caribbean	Spinning Disk	Multi #3811R 0630 Motor (Vibrator) 12VDC (041-5029-04) 3100 RPM (w/DRL PTS) -04 is RoHS compliant; can substitute with -01 domestic	511-5024-04 <i>incl. Connector</i>
	Pirate Ship Sinking/Raising Movement	Multi Products Motor & Gear Box 24VDC Model #7000-DCM 12 RPM	041-5101-00 MOTOR ONLY
Family Guy™	Stewie Figurine Left & Right Movement	Stepper Motor NPM PF35T-48D4STD 5V RVB (041-5102-00 Reference Only)	511-5043-00 <i>incl. Connector</i>
Spider-Man™	Doc Ock, Sandman & 3-Bank Up/Down Movement	Sync. Motor 24VAC 50/60Hz 3W 12 RPM CW (041-5103-00 Reference Only)	511-5063-00 <i>incl. Connector</i>
	▶▶▶ OPTIONAL ◀◀◀ Shaker Motor Kit 502-5027-00	Multi #3811R 0630 Motor (Vibrator) 12VDC (041-5029-04) 3100 RPM (w/DRL PTS) -04 is RoHS compliant; can substitute with -01 domestic	515-5893-01 <i>incl. Connector</i>



APPENDIX F

Motor Specification Table

The following table only list games that used motors. Part Numbers starting with "515-" will include the Wiring Harness & Connector.

Game Name	Function	Specifications	Part N ^o
ABC Monday Night Football	Goal Post Up/Down Movement	Motor 24v A.C. 60 RPM CW	515-5222-00
Phantom of the Opera	Organ Up/Down Movement	Bowman Motor 24v 60Hz 3W 11 RPM CCW	515-5256-00
Checkpoint	Mag Wheel (in Backbox)	Motor D.C. (KEN)	041-5005-00
	Shaker	Johnson Motor (Vibrator)	041-5002-00
Teenage Mutant Ninja Turtles	Spinning Pizza Ball Deflector	Gear Motor 24v A.C. 325 RPM CW	515-5397-00
Batman	Bar Target Up/Down Movement	Bowman Motor 24v 60Hz 3W 11 RPM CCW	515-5256-00
Star Trek 25th Anniversary	Swinging Target	Bowman Motor 24v 22½ RPM	515-5534-00
	Transporter F/X	Gear Motor 24v A.C. 3½ RPM	500-5421-00
	Cooling Fan (for Transporter F/X)	4½" Motor 12v	041-5014-00
Lethal Weapon 3	Spinning Light	Motor 2½ v A.C. 4000 RPM CCW	041-5017-00
Star Wars	Bar Target Up/Down Movement	Bowman Motor 24v 60hz 3W 11 RPM CCW	515-5256-00
	R2D2 Robot Left/Right Movement	Bowman Motor 24v A.C. 22½ RPM CW	515-5571-00
	Death Star Rotation	Bowman "G" Motor 24v A.C. 60Hz 6 RPM CW	515-5570-00
Rocky & Bullwinkle & Friends	Nell Log "Cutting Blade" Forward/Back Movement	Autotrol Model E Motor 24v 60hz 4W 3 RPM CCW	041-5023-00
Jurassic Park	T-Rex Left/Right Movement	Multi Motor 5v D.C.	041-5025-00
	T-Rex Up/Down Movement	Bowman Motor 24v 11 RPM CW	041-5026-00
	Shaker	Johnson Motor (Vibrator)	041-5002-00
Last Action Hero	Crane Left/Right Movement	Multi Products Motor 12v D.C. #3312 OSC	041-5027-00
	Shaker	Johnson Motor (Vibrator) 10.5v D.C. 10 AMP 2950 RPM CW	041-5029-00
Tales from the Crypt	Tombstone Up/Down Movement	Bowman Motor 24v A.C. 6 RPM CCW	515-5900-00
	Shaker	Johnson Motor (Vibrator) 10.5v D.C. 10 AMP 2950 RPM CW	041-5029-00
The Who's Tommy	Mirror Up/Down Movement	Bowman Motor 24v A.C. 6 RPM CCW	515-5900-00
	Flipper Blinders	Servo Motor (94102)	041-5032-00
	Spinning Airplane Propellers	Motor D.C.	041-5033-00
WWF Royal Rumble	Shaker	Johnson Motor (Vibrator) 10.5v D.C. 10 AMP 2950 RPM CW	041-5029-00
Maverick, The Movie	Turning Paddle Wheel	Motor 24v A.C. 10 RPM	041-5036-00
Mary Shelley's Frankenstein	Creature Head Left/Right Movement	Servo Motor (94102)	041-5032-00
Batman Forever	Cannon Left/Right Movement	Bowman Motor 24v A.C. 60Hz 3W 6 RPM CCW	515-6383-00

APPENDIX G

Part Number Prefix Classification Codes

I. Electrical Source, Energy & Signal Converters

- 010- Transformers
- 031- Speakers
- 090- Solenoids (Coils)
- 150- Filters, Outlets, Varistors, Thermistors
- 200- Fuses

II. Conductors, Connectors & Insulators

- 034- Line Cords
- 036- Cable Assemblies & Wiring Harnesses
- 041- Motors
- 045- Connectors (All Types)
- 055- Lugs (M/F), Pins (M/F), Discs, Ring Terminals, Terminal Strips, etc.
- 060- Polarizing Keys and Conn. Covers
- 077- Lamp Sockets

III. Circuits & Circuit Elements

- 100- ICs
- 110- Transistors
- 112- Diodes (All Types including LEDs & Modules)
- 121- Resistors
- 123- Resistors (Variable & Adjustable)
- 124- Regulators & Bridge Rectifiers
- 125- Capacitors (Radial Lytics & Ferrites)
- 126- Piezo Crystal
- 127- Heatsinks
- 130- Capacitors (Tectates & Ceramics)
- 140- Oscillators (Clocks/Crystals)
- 165- Light Bulbs
- 180- Switches
- 181- Switch Membranes (Pads) & Piezo Sensors
- 190- Relays
- 960- EPROM (*Raw Part*)
- 965- EPROM (*Programmed Part*)

IV. Bolts, Screws, Nuts, Washers & Nails

- 231- Bolts
- 232- Screws (Pan Head)
- 234- Screws (HWH)
- 237- Screws (Misc.)
- 240- Nuts (Misc.)
- 242- Washers (Flat, Round)
- 244- Washers (Split Lock)
- 245- Nyloners
- 246- Washers (Lockers, External Tooth)
- 281- Nails

V. Mechanical Components

- 249- Rivets
- 251- Pins (Dowel), Finishing Nails, Hairpins, Spring Pins and Clevis Pins
- 254- Stand-Offs, Spacers and Shims
- 260- Steel Ball (All Types Steel, Glowing, Delrin, etc.)
- 265- Springs (Extension)
- 266- Springs (Compression)
- 267- Springs (Torsion)
- 269- Springs (Washers - Belleville, Wave)
- 270- Retaining Rings
- 280- Grommets, Bushings and Nyloners
- 283- Bearings

VI. Handles, Locks, Catches, Latches, Keys

- 355- Handles, Locks, Catches, Latches and Keys

VII. Fabricated Parts

- 390- Hinges
- 501- Coin Doors
- 515- Sub-Assemblies
- 520- Printed Circuit Boards (PCBs)
- 522- Display Glass
- 525- Wood Parts
- 530- Screw Machined Parts
- 535- Fabricated Parts
- 545- Molded (Extruded) Plastic and Rubber Parts (Rings, Sleeves, etc.)
- 550- Molded (Inserts)

VIII. In-House Assemblies

- 500- End Product (Systems and Models)
- 502- Kits (Created In-House)
- 505- Cabinets (complete)
- 510- Riveted Sub-Assemblies (In-House)
- 511- Sub-Assemblies (In-House)
- 515- Sub-Assemblies*

*2 or more 515-'s but still a sub-assembly.

IX. Bulk Materials

- 600- Braided Wire & Ground Straps
- 601- Stranded Wire
- 602- Ribbon Cable
- 604- Telephone Line Cord
- 605- Sleeving (Shrink Tubing)
- 625- Velcro (non-adhesive)
- 626- Foam Rubber, Foam Pads, Rubber Bumpers (Blue Pads), Tape (All Types) Velcro (adhesive) and String / Rope













X. Miscellaneous

- 000- Tools (*see also 777-*) and Supplies
- 040- Clamps, Ties & Clips
- 042- Pulleys
- 091- Coin Mechs
- 205- Fuse Holders
- 631- Staples
- 660- Glass (Playfield, Backglass, etc.)
- 675- Cleaners
- 705- Packing & Shipping Items
- 755- Instruction, Coin Cards, Ins. Sheets
- 756- Information Sheets, Service Bulletins, Instruction Sheets in Kits and Templates
- 777- Tools (Wrenches and Drivers)
- 780- Manuals
- 802- Decal Kits (comprised of 820's)
- 820- Decals, Mylar and Labels (Sheets/Sets)
- 803- Plastic Kits (comprised of 830's)
- 830- Plastic Pieces (Butyrate Sheets/Sets)
- 880- Toys, Models, Figurines, etc.
- 900- Game Posters

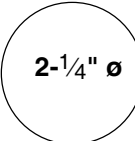
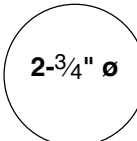
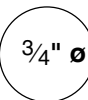
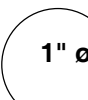
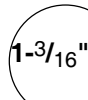
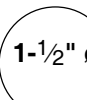
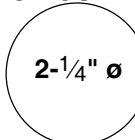
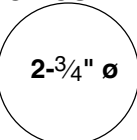

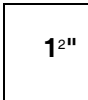
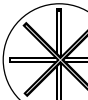
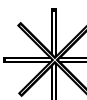
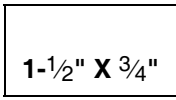
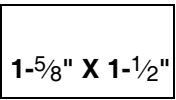
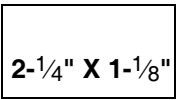
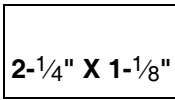
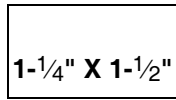
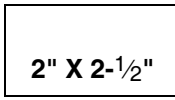
APPENDIX H

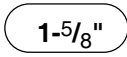
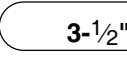
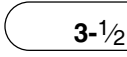
Playfield Inserts (Plastic Light Covers)

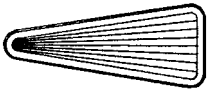
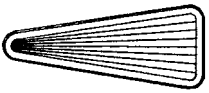
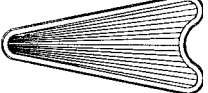
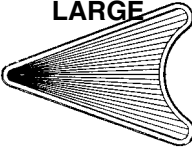
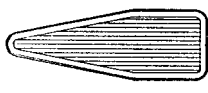
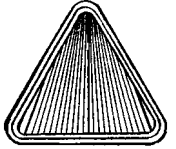
Patterns: STARBURST  STIPPLE 	STARBURST CIRCULAR  550-5000-XX	STARBURST CIRCULAR  550-5001-XX	STARBURST CIRCULAR  550-5002-XX	STARBURST CIRCULAR  550-5003-XX	STARBURST CIRCULAR  550-5004-XX
STARBURST CIRCULAR  550-5005-XX	STARBURST CIRCULAR  550-5006-XX	PLAIN CIRCULAR  550-5007-XX	PLAIN CIRCULAR  550-5008-XX	PLAIN CIRCULAR  550-5009-XX	PLAIN CIRCULAR  550-5010-XX
PLAIN CIRCULAR  550-5011-XX	PLAIN CIRCULAR  550-5012-XX	STIPPLE CIRCULAR  550-5048-XX	STIPPLE 1" SQUARE  550-5019-XX	ROLLOVER BUTTON BASE  550-5026-XX	WHITE STAR (only in white)  545-5015-00
STIPPLE RECTANGULAR  550-5018-XX	STIPPLE RECTANGULAR  550-5051-XX	STARBURST RECTANGULAR  550-5044-XX	PLAIN RECTANGULAR  550-5049-XX	PLAIN RECTANGULAR  550-5050-XX	PLAIN RECTANGULAR  550-5063-XX
STARBURST MINI SHIELD  550-5024-XX	STARBURST LARGE SHIELD  550-5025-XX	MINI HOT DOG  550-5020-XX	BEVEL HOT DOG  550-5021-XX	PLAIN HOT DOG  550-5022-XX	BANANA  550-5023-XX
STARBURST ARROW-SMALL  550-5013-XX	STARBURST ARROW-LARGE  550-5070-XX	STARBURST ARROW-HEAD SMALL  550-5014-XX	STARBURST ARROW-HEAD LARGE  550-5015-XX	STARBURST BULLET  550-5016-XX	STARBURST TRIANGLE  550-5017-XX

Note: The shapes and sizes shown above are not to scale. Some shapes may no longer be available in every color.

Instructions: Parts which may come in various colors (i.e. targets, some posts, playfield inserts, etc.) end in a 2-digit number which correspond to the color of that part. The "-XX" in part number which may come in various colors should be replaced with the desired 2-Digit number corresponding to the color desired below. *Not all colors may be available.*

PLASTIC PART COLOR CHART											
Nº	Color	Nº	Color	Nº	Color	Nº	Color	Nº	Color	Nº	Color
-00	Black or Solid Clear	-03	Amber	-06	Yellow	-09	Purple	-12	Fluor. Blue	-15	Luminescent
-01	Clear	-04	Green	-07	Orange	-10	Fluor. Orange	-13	Teal Green	-16	Gold
-02	Red	-05	Blue	-08	White	-11	Fluor. Green	-14	Gray	-17	Trans. Brown

APPENDIX I

Anti-Loft Stand-Up Targets

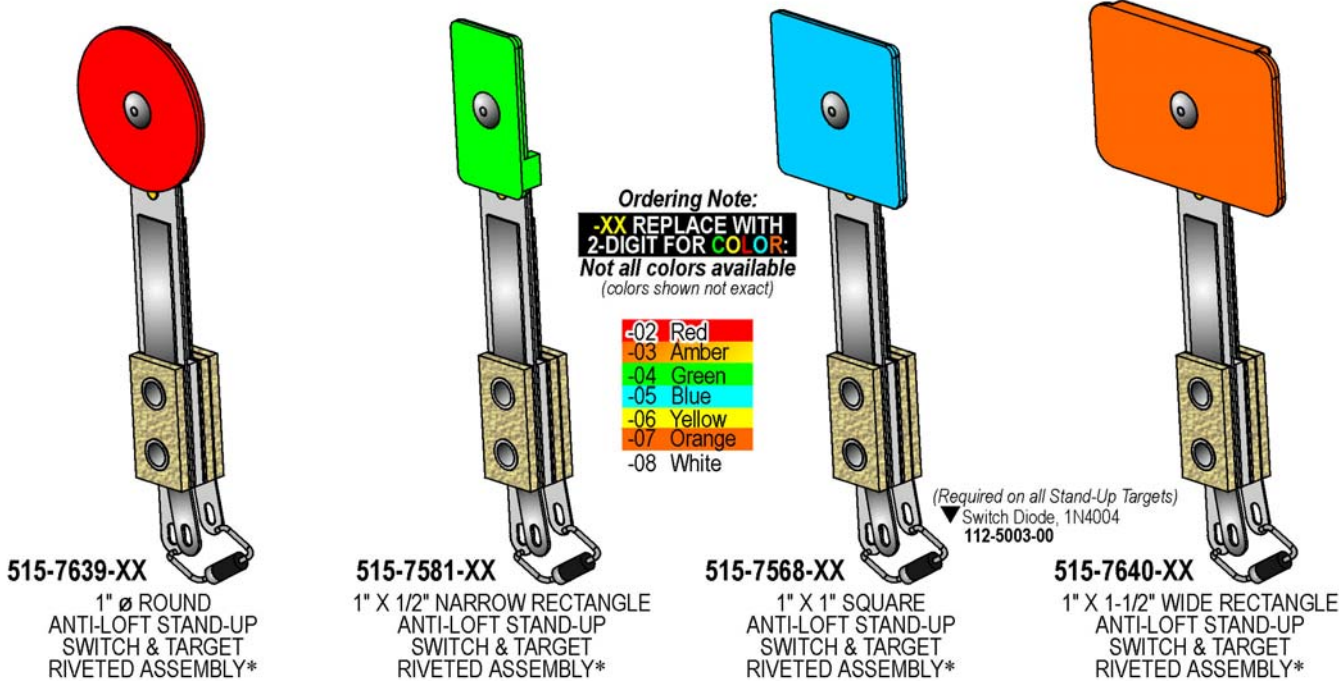

*Some targets may require the lugs position be changed to the left or to the right, depending on the application; these targets will have a different part number and are called out in the game manual they are used in (see Section 4, Chapter 1, Parts Identification & Location, Playfield ... -Switches.) Review the game manual for the game desired for the original target used or application.

For Anti-Loft Application use
 Large Foam Pad,
 5/8" X 7/16" X 3/16" Thick
626-5078-00

For > Light < Anti-Loft Application use
 Small Foam Pad,
 7/16" X 7/16" X 1/8" Thick
626-5029-00

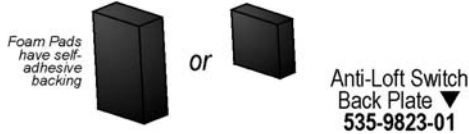

ASM. REF. IN-HOUSE USE ONLY:
Light Anti-Loft Stand-Up Target Assemblies which includes the Anti-Loft Switch Back Plate, Switch Mounting Bracket and Foam Pad (Small): 500-5835-XX (ROUND), 500-5857-XX (NARROW), 500-5232-XX (SQUARE) and 500-5321-XX (RECTANGLE).

Anti-Loft Stand-Up Target Assemblies which includes the Anti-Loft Switch Back Plate, Switch Mounting Bracket and Foam Pad (Large): 500-7082-XX (ROUND), 500-6985-XX (NARROW), 500-6984-XX (SQUARE) and 500-7063-XX (RECTANGLE).

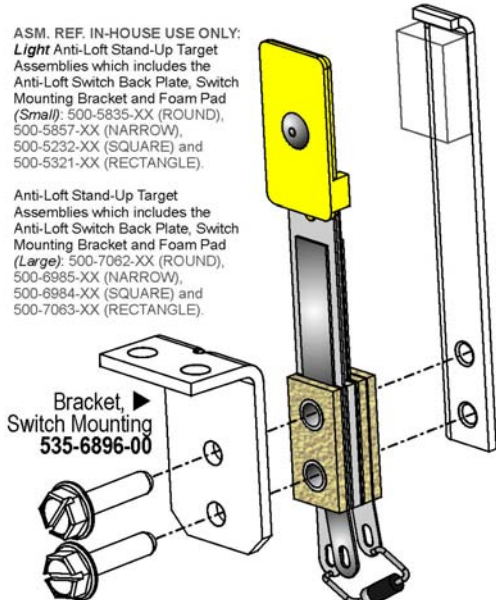

▲ #6-32 X 5/8" Slotted HWH Swage (Zinc) Screws (Qty. 2/per) **237-5976-04**

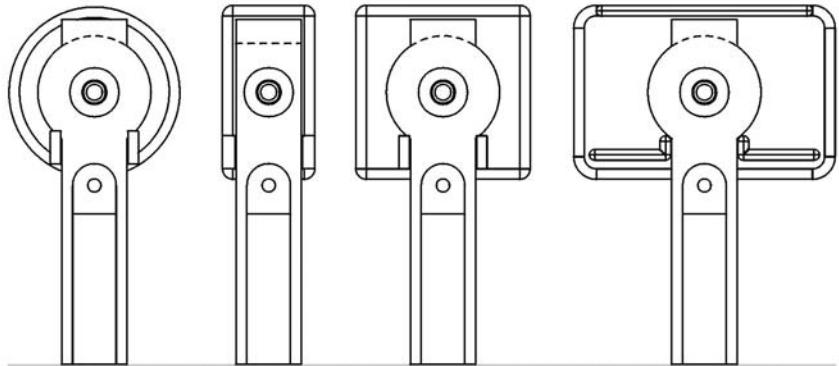

REAR VIEWS OF ANTI-LOFT TARGET & SWITCH ASSEMBLIES

The material of the Anti-Loft Switch has been extended higher to be used with the Anti-Loft Switch Back Plate. **IMPORTANT:** Switch & Target Assemblies (X) without the extension (the predecessors) **SHOULD NOT** be used with an Anti-Loft Switch Back Plate (shown left).

APPENDIX REFERENCE FOR PINBALL GAMES WHICH USED THE BELOW SWITCH & TARGET ASSEMBLIES NOTE:

The Switch & Target Assemblies (X) without the extension have the following part numbers*: 515-5966-XX (Round), 515-5967-XX (Narrow), 515-5162-XX (Square) and 515-6027-XX (Rectangle) and should only be used with the Switch Back Plate (shown right), 535-6452-00 and Small Foam Pad, 626-5029-00.

* If the above referenced part numbers are no longer available from the factory or your distributor, it will be substituted with the appropriate Anti-Loft counterpart. Not all colors may be available.

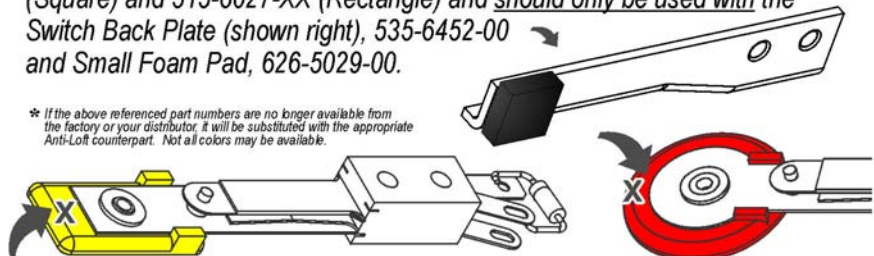

APPENDIX I

Modular Stand-Up Targets

R means «Target Insert» is reversed, allowing for Rear Mounted application.

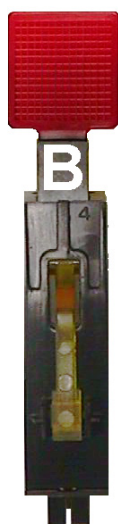
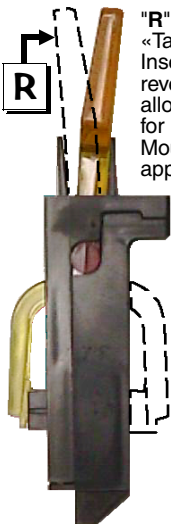

Take Note:

- Items A-E come in various colors. These targets may not be available in every color. The "-XX" in should be replaced with the desired 2-Digit number for the color desired as described in the Color Chart below. As of print date, the following colors were used :
 -01 Clear (A, D); -02 Red (A, B, C, D, E); -03 Amber (D, E);
 -04 Green (A, B); -05 Blue (C); -06 Yellow (A, C),
 -09 Purple (B, D); -11 Fluorescent Green (A, B, D)
- For location(s) and type of Stand-Up Targets used, if any, see Section 4, Chapter 1, Parts Identification & Location.

XX REPLACE WITH 2-DIGIT FOR COLOR:

- 00 Black
- 01 Clear
- 02 Red
- 03 Amber
- 04 Green
- 05 Blue
- 06 Yellow
- 07 Orange
- 08 White
- 09 Purple
- 10 Fluor. Orange
- 11 Fluor. Green
- 12 Fluor. Blue
- 13 Teal Green
- 14 Gray
- 15 Luminescent
- 16 Gold

Note: Not all colors available.

Nr.	STAND-UP TARGET PARTS	SPI PART Nr.
A	Modular Stand-Up Target Narrow Assy.	500-6138-XX
	Stand-Up Target Narrow (Insert)	545-6138-XX
B	Modular Stand-Up Target Square Assy.	500-6139-XX
	Stand-Up Target Square (Insert)	545-6139-XX
C	Modular Stand-Up Target Rectangle Assy.	500-6228-XX
	Stand-Up Target Rectangle (Insert)	545-6228-XX
D	Modular Stand-Up Target Round Assy.	500-6075-XX
	Stand-Up Target Round (Insert)	545-6075-XX
E	Mod. Stand-Up Target 1" Spherical Assy.	500-6189-XX
	Stand-Up Target 1" Spherical (Insert)	545-6189-XX

To Replace the « Target Insert » or change Target Orientation :

Items A-E Note: For the Target Assembly use the "500-" SPI Part Number(s) shown in the Parts Table below. To receive the Target Assembly with the « Target Insert » « Reversed » simply add a "R" at the end of the Part Number. See Side View picture left to compare (dashed line shows target reversed). For just the «Target Insert» use the "545-" SPI Part Number.

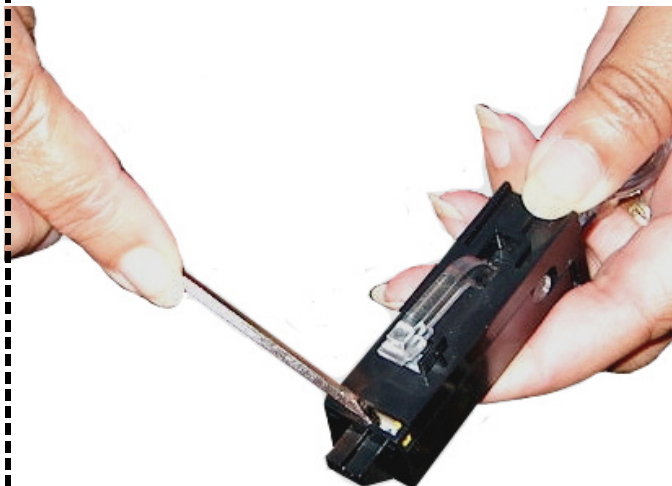

To reverse it yourself or to just change the insert:

- With a small flat head screwdriver, push into the small tab at the bottom of the target front and give a slight twist motion to "pop" the two halves.

- Push the Target Insert bottom in at the same time while you slide the top (front) part up, then let go of the insert as the two halves come apart.

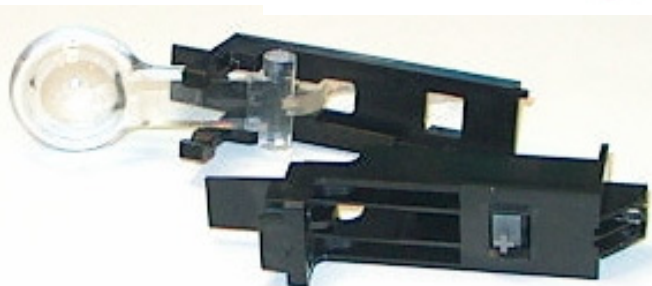

- Replace target or reinsert it into the other size while sliding the two halves back together.

Note: If you were reversing the orientation, don't forget to also turn the Switch Actuator PCB 180°. Test Switch.

APPENDIX J

Coin Cards (USA & International Pricing Defaults) ▶ For Yellow Stock add -Y to the Part Number

If more than one Pricing Scheme is available for countries listed, the **F.** listed beside the option, denotes the Factory Default Setting.
FOR VIEWS OF THE LATEST or OPTIONAL USA, INTERNATIONAL / EURO AND CUSTOM COIN CARDS, VISIT OUR WEBSITE.
 Not Shown USA 755-5400-10 Tournament Option \$2 = X1; 755-5400-11 Tournament Option \$1.50 = X1

USA 10 F. 755-5400-11 Front		USA 10 755-5400-11 Back		USA 2-7 or CANADA 755-5400-02 Front		FOR CUSTOM PRICING † 755-5400-01, -02 or -04 Back		USA 3 with ToPS™ 755-5400-03 or -09 Front		USA 5 with ToPS™ 755-5400-03 Back / -08 Front	
AUSTRALIA 1 F. 755-5406-00 Front		AUSTRALIA 2 755-5406-00 Back		CROATIA 755-5410-00 Front		FOR CUSTOM PRICING † 755-5410-00 Back		DENMARK 1 F. 755-5402-00 Front		DENMARK 2 755-5402-00 Back	
JAPAN 1 755-5408-01 Front		JAPAN 2 F. 755-5408-01 Back		MIDDLE EAST 755-5400-06 Front		ANY COUNTRY CAN USE 755-5400-06 Back		NEW ZEALAND 1 F. 755-5406-00 Back		NEW ZEALAND 2 755-5406-00 Front	
NORWAY 1 F. 755-5403-01 Front		NORWAY 2 755-5403-01 Back		RUSSIA F. 755-5411-00 Front		RUSSIA (ALTERNATE) 755-5411-00 Back		SOUTH AFRICA 755-5409-01 Front		FOR CUSTOM PRICING † 755-5409-01 Back	
SWEDEN 1 F. 755-5404-00 Front		SWEDEN 2 755-5404-00 Back		SWITZERLAND 1 F. 755-5405-00 Front		SWITZERLAND 2 755-5405-00 Back		TAIWAN 755-5412-00 Front		FOR CUSTOM PRICING † 755-5412-00 Back	
UK 1 755-5407-00 Front		UK 3 755-5407-00 Back		UK 5 F. 755-5407-01 Front		FOR CUSTOM PRICING † 755-5407-01 Back		Appendix J Notes: 1. Coin Card on Game is determined by original shipping country destination. 2. Optional Coin Card(s), are available via your distributor or via free download @ www.sternpinball.com/coinagecards.shtml . Older style Coin Cards (foreign or domestic) not available on our website or no longer available through your distributor, are obsolete. 3. Coin Cards which have a Blank Backside can be used for †Custom Pricing.			

Not Shown EURO 755-5401-20 Tournament Custom (can fill in your own pricing).

EURO 1 755-5401-01 1-Side Only		EURO 2 755-5401-02 1-Side Only		EURO 3 755-5401-03 1-Side Only		EURO 4 755-5401-04 1-Side Only		EURO 5 755-5401-05 1-Side Only		EURO 6 755-5401-06 1-Side Only	
EURO 7 755-5401-07 1-Side Only		EURO 8 755-5401-08 1-Side Only		EURO 9 755-5401-09 1-Side Only		EURO 10 755-5401-10 1-Side Only		EURO 11 755-5401-11 1-Side Only		EURO 12 755-5401-12 1-Side Only	

▶ EURO FACTORY DEFAULT SUMMARY TABLE ◀

EURO 1	EURO 2	EURO 3	EURO 4	EURO 5	EURO 6	EURO 7	EURO 8	EURO 9	EURO 10	EURO 11	EURO 12
BELGIUM ITALY 1 PORTUGAL	GERMANY 2	NETHERLANDS SPAIN			GREECE		FINLAND	AUSTRIA	FRANCE		

Section 3, Chapter 4, GO TO ADJUSTMENTS MENU, Adj. 18, Game Pricing, USA & International (non-Euro) and Euro 1-12 Summary & International (Euro) Standard Pricing Select Tables, summarizes Standard or Custom Pricing Schemes & the Dip Switch Setting required.





In SWITCH MENU also select:

ACTIVE and DEDICATED SWITCH TESTS

SWITCH MATRIX GRID & DEDICATED SWITCHES (for notes & locations, see Page DR. 4 or 17)

Column (Drive)	1: Q1	2: Q2	3: Q3	4: Q4	5: Q5	6: Q6	7: Q7	8: Q8	GROUND	GROUND
Row (Return)	GRN-BRN CN5-P1	GRN-RED CN5-P3	GRN-ORG CN5-P4	GRN-YEL CN5-P5	GRN-BLK CN5-P6	GRN-BLU CN5-P7	GRN-VIO CN5-P8	GRN-GRY CN5-P9	IC U206 INPUTS	BLK CN6-P1, -P11
1: U400	1 Cabinet Side WHT-BRN CN7-P9 LT BUTTON (UK ONLY) Sw. Part Number: 180-5160-00	9 Below P/F LEFT VUK Sw. Part Number: 180-5116-01	17 Above P/F SWORD LOCK HIGH Sw. Part Number: 180-5119-02	25 Above P/F RIGHT RAMP ENTER Sw. Part Number: 180-5010-01	33 Mini-P/F MINI PF U.L. Sw. Part Number: 180-5057-00	41 Top P/F TOP VUK Sw. Part Number: See Sw. 41 Note	49 Below P/F LEFT BUMPER Sw. Part Number: 180-5015-03	57 Below P/F LEFT OUTLANE Sw. Part Number: 500-6227-02	1: U206 GRY-BRN CN6-P2 Sw. Part Number: 180-5160-00	DS-1 on Cabinet Side #1 LEFT FLIPPER BUTTON
2: U400	2 Coin Door WHT-RED CN7-P8 4TH COIN SLOT Sw. Part Number: 180-5204-00	10 Below P/F STANDUP Sw. Part Number: 515-6027-08	18 Above P/F SWORD LOCK MID Sw. Part Number: 180-5119-02	26 NOT USED	34 Mini-P/F MINI PF U.R. Sw. Part Number: 180-5057-00	42 Above P/F INNER LOOP Sw. Part Number: 180-5190-28	50 Below P/F RIGHT BUMPER Sw. Part Number: 180-5015-03	58 Below P/F LEFT RETURN LANE Sw. Part Number: 500-6227-02	2: U206 GRY-RED CN6-P3 Sw. Part Number: 180-5149-00 on Flipper	DS-2 Below Playfield #2 LEFT FLIPPER E.O.S (End-of-Stroke)
3: U400	3 Coin Door WHT-ORG CN7-P7 6TH COIN SLOT Sw. Part Number: Future Use	11 Below P/F 4-BALL TROUGH #1 (LEFT) Sw. Part Number: 180-5119-02	19 Above P/F SWORD LOCK LOW Sw. Part Number: 180-5119-02	27 NOT USED	35 Mini-P/F MINI PF L.L. Sw. Part Number: 180-5057-00	43 Below P/F LEFT TOP LANE Sw. Part Number: 500-6227-02	51 Below P/F BOTTOM BUMPER Sw. Part Number: 180-5015-03	59 Below P/F LEFT SLINGSHOT Sw. Part Number: 180-5054-00 (x2)	3: U206 GRY-ORG CN6-P4 Sw. Part Number: 180-5160-00	DS-3 on Cabinet Side #3 RIGHT FLIPPER BUTTON
4: U400	4 Coin Door WHT-YEL CN7-P6 RIGHT COIN SLOT Sw. Part Number: 180-5204-00	12 Below P/F 4-BALL TROUGH #2 Sw. Part Number: 180-5119-02	20 Below P/F RIGHT ORBIT LOW Sw. Part Number: 500-6227-02	28 Above P/F BALROG HIT Sw. Part Number: 180-5119-00	36 Mini-P/F MINI PF L.R. Sw. Part Number: 180-5057-00	44 Below P/F MIDDLE TOP LANE Sw. Part Number: 500-6227-02	52 Above P/F SPINNER Sw. Part Number: 180-5190-28	60 Below P/F RIGHT OUTLANE Sw. Part Number: 500-6227-02	4: U206 GRY-YEL CN6-P6 Sw. Part Number: 180-5149-00 on Flipper	DS-4 Below Playfield #4 RIGHT FLIPPER E.O.S (End-of-Stroke)
5: U401	5 Coin Door WHT-GRN CN7-P5 CENTER COIN SLOT / DBA Sw. Part Number: 180-5204-00	13 Below P/F 4-BALL TROUGH #3 Sw. Part Number: 180-5119-02	21 Above P/F RIGHT ORBIT HI Sw. Part Number: 180-5190-28	29 Below P/F PALANTIR Sw. Part Number: 515-5162-08	37 Below P/F LEFT ORBIT LOW Sw. Part Number: 500-6227-02	45 Below P/F RIGHT TOP LANE Sw. Part Number: 500-6227-02	53 Below P/F SPOT RING Sw. Part Number: 515-5162-08	61 Below P/F RIGHT RETURN LANE Sw. Part Number: 500-6227-02	5: U206 GRY-GRN CN6-P7 Sw. Part Number: NOT USED	DS-5
6: U401	6 Coin Door WHT-BLU CN7-P3 LEFT COIN SLOT Sw. Part Number: 180-5204-00	14 Below P/F 4-BALL TROUGH VUK OPTO Sw. Part Number: See Sw. 14 Note	22 Above P/F RAIL RAMP EXIT Sw. Part Number: 180-5197-00	30 Below P/F RIGHT VUK Sw. Part Number: 180-5116-01	38 Below P/F LEFT ORBIT HI Sw. Part Number: 500-6227-02	46 Below P/F TOP SAUCER Sw. Part Number: 180-5186-00	54 In Cabinet START BUTTON Sw. Part Number: 180-5174-00	62 Below P/F RIGHT SLINGSHOT Sw. Part Number: 180-5054-00 (x2)	6: U206 GRY-BLU CN6-P8 Sw. Part Number: 180-5192-02	DS-6 on Coin Door #6 VOLUME (RED BUTTON) (In Test: LEFT)
7: U401	7 Coin Door WHT-VIO CN7-P2 5TH COIN SLOT Sw. Part Number: Future Use	15 Below P/F 4-BALL STACKING OPTO Sw. Part Number: See Sw. 15 Note	23 Above P/F RIGHT RAMP TARGET Sw. Part Number: 515-6027-08	31 Below P/F BALROG OPEN Sw. Part Number: 180-5119-02	39 Below P/F LEFT RAMP ENTER Sw. Part Number: 500-6227-02	47 Back Panel RING MADE Sw. Part Number: See Sw. 47 Note	55 In Cabinet TOURNAMENT START Sw. Part Number: 180-5174-00	63 NOT USED	7: U206 GRY-VIO CN6-P9 Sw. Part Number: 180-5192-04	DS-7 on Coin Door #7 SERV. CRED. (GREEN BUTTON) (In Test: RIGHT)
8: U401	8 Cabinet Side WHT-GRY CN7-P1 RT BUTTON (UK ONLY) Sw. Part Number: 180-5160-00	16 Below P/F SHOOTER LANE Sw. Part Number: 180-5157-00	24 Above P/F RIGHT RAMP MADE Sw. Part Number: 180-5198-00	32 Below P/F BALROG CLOSED Sw. Part Number: 180-5119-02	40 Above P/F LEFT RAMP MADE Sw. Part Number: 180-5010-01	48 Back Panel BACK TROUGH Sw. Part Number: 180-5057-00	56 In Cabinet PLUMB BOB TILT Sw. Part Number: See Sw. 56 Note	64 NOT USED	8: U206 GRY-BLK CN6-P10 Sw. Part Number: 180-5192-00	DS-8 on Coin Door #8 BEGIN TEST (BLACK BUTTON) (In Test: ENTER)



In LAMP MENU also select:

TEST ALL LAMPS, ROW & COLUMN LAMP TESTS

LAMP MATRIX GRID (for notes & locations, see Page DR. 5 or 23)

Column (18v)	1: U17	2: U16	3: U15	4: U14	5: U13	6: U12	7: U11	8: U10
Row (Ground)	YEL-BRN J13-P9	YEL-RED J13-P8	YEL-ORG J13-P7	YEL-BLK J13-P6	YEL-GRN J13-P5	YEL-BLU J13-P4	YEL-VIO J13-P3	YEL-GRY J13-P1
1: Q33	1 #555 Bulb RED-BRN J12-P1 (K) EEP	2 #555 Bulb K (E) EP	3 #555 Bulb KE (E) P	4 #555 Bulb KEE (P)	5 #555 Bulb THE FELLOWSHIP OF THE RING	6 #555 Bulb THE TWO TOWERS	7 #555 Bulb THE RETURN OF THE KING	8 #555 Bulb SHOOT AGAIN
2: Q34	9 #555 Bulb RED-BLK J12-P2 PIPPIN	10 #555 Bulb MERRY	11 #555 Bulb SAM	12 #555 Bulb ARAGORN	13 #555 Bulb FRODO	14 #555 Bulb GANDALF	15 #555 Bulb LEGOLES	16 #555 Bulb GIMLI
3: Q35	17 #555 Bulb RED-ORG J12-P3 BOROMIR	18 #555 Bulb MYSTERY	19 #555 Bulb FRODO ARROW	20 #44 Bulb DESTROY RING	21 #555 Bulb MODE START	22 #555 Bulb PALANTIR	23 #44 Bulb PALANTIR GLOBE	24 #555 Bulb SPOT RING
4: Q36	25 #555 Bulb RED-YEL J12-P4 PIPPIN ARROW	26 #555 Bulb GIFT OF THE ELVES	27 #555 Bulb LIGHT EXTRA BALL	28 #555 Bulb RING MULTIBALL	29 #555 Bulb BIG POINTS	30 #555 Bulb LIGHT SPECIAL	31 #555 Bulb SUPER RING FRENZY	32 #555 Bulb 2X SCORING
5: Q37	33 #555 Bulb RED-GRN J12-P5 LEGOLES ARROW	34 #555 Bulb L RAMP MAN RING	35 #555 Bulb L RAMP DWARF RING	36 #555 Bulb L RAMP ELF RING	37 #555 Bulb GANDALF ARROW	38 #555 Bulb C LOOP MAN RING	39 #555 Bulb C LOOP DWARF RING	40 #555 Bulb C LOOP ELF RING
6: Q38	41 #555 Bulb RED-BLU J12-P6 GIMLI ARROW	42 #555 Bulb EXTRA BALL	43 #555 Bulb GOLLUM MULTIBALL	44 #555 Bulb SPECIAL	45 #555 Bulb MERRY ARROW	46 #555 Bulb R ORBIT MAN RING	47 #555 Bulb R ORBIT DWARF RING	48 #555 Bulb R ORBIT ELF RING
7: Q39	49 #555 Bulb RED-VIO J12-P8 ARAGORN ARROW	50 #555 Bulb R RAMP MAN RING	51 #555 Bulb R RAMP DWARF RING	52 #555 Bulb R RAMP ELF RING	53 #555 Bulb LOCK	54 #555 Bulb LANES	55 #555 Bulb TOWER	56 #555 Bulb FLIPPER
8: Q40	57 #555 Bulb RED-GRY J12-P9 (O) RC	58 #555 Bulb O (R) C	59 #555 Bulb OR (C)	60 #555 Grn. Bulb POTD U.L.	61 #555 Grn. Bulb POTD U.R.	62 #555 Grn. Bulb POTD L.L.	63 #555 Grn. Bulb POTD L.R.	64 #44 Bulb SHOOTER LANE #1 BOT
9: Q41	65 #44 Bulb RED-WHT J12-P10 SHOOTER LANE #2	66 #44 Bulb SHOOTER LANE #3	67 #44 Bulb SHOOTER LANE #4	68 #44 Bulb SHOOTER LANE #5	69 #44 Bulb SHOOTER LANE #6	70 #44 Bulb SHOOTER LANE #7	71 #44 Bulb SHOOTER LANE #8	72 #44 Bulb SHOOTER LANE #9 TOP
10: Q42	73 #44 Bulb RED J12-P11 ESCAPE THE RINGWRAITHS	74 #44 Bulb GANDALF VS SARUMAN	75 #44 Bulb WARG ATTACK	76 #44 Bulb WAR OF THE ENTS	77 #44 Bulb BATTLE WITH SHELOB	78 #44 Bulb DESTROY THE WITCH-KING	79 #555 Bulb TOURNAMENT BUTTON	80 #555 Bulb START BUTTON

▼ U.S. ▼
Customary
Inch Ruler

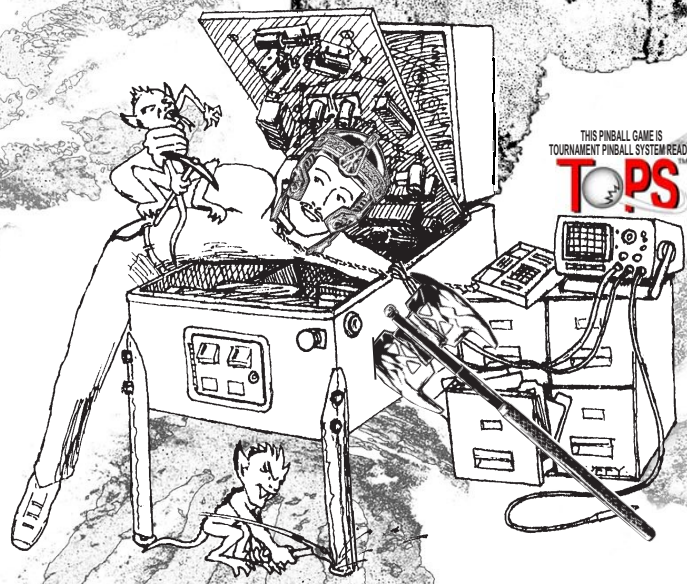

Metric Conversion

$1/16''$
 $1/8''$
 $1/4''$
 $1/2''$
 $3/4''$
 $1''$
 $1/32''$ (.03125")
 $.0625''$
 $.125''$
 $.25''$
 $.5''$
 $.75''$
 $1'' = 2.54\text{cm} / 25.4\text{mm}$
 $1\text{cm} = .3937''$
 $1\text{mm} = .03937''$

- For metric, multiply inch value by metric value, e.g. 5" X 2.54cm = 12.7cm or 127mm.
- For US, multiply metric value by inch value, e.g. 13cm X .3937" = 5.1181"



<http://www.SternPinball.com>

Visit our website for Pinball game information, Technical Support & Part Sales (for Service Bulletins and a whole lot more!), Stern News, Pinball Links and Distributor Listings. **HELP US, HELP YOU!** If you have any suggestions, questions, need technical advice, find errors or have comments, contact us through our website or call!

This Game Service Manual and all other documents relating to this product, playfield components, features, rules, programming and operation are subject to change without notice (Service Bulletins, if applicable, available through our website).



2020 Janice Avenue, Melrose Park, IL 60160

1-800-700-8000
 708-345-7700 (Option 1) Fax 708-345-7889
 email parts.service@SternPinball.com

