

**RACIN' FORCE WIRING DIAGRAM**

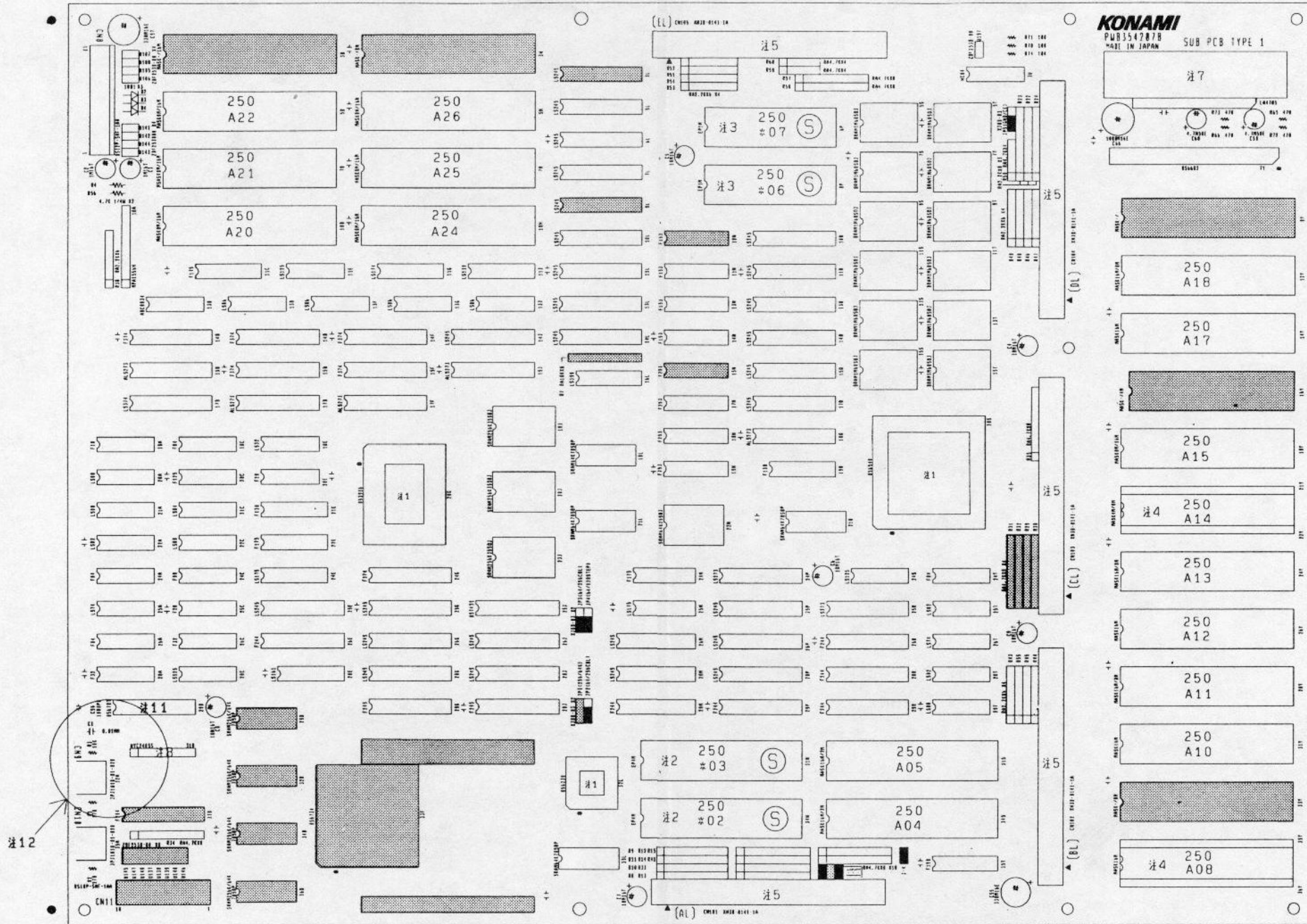

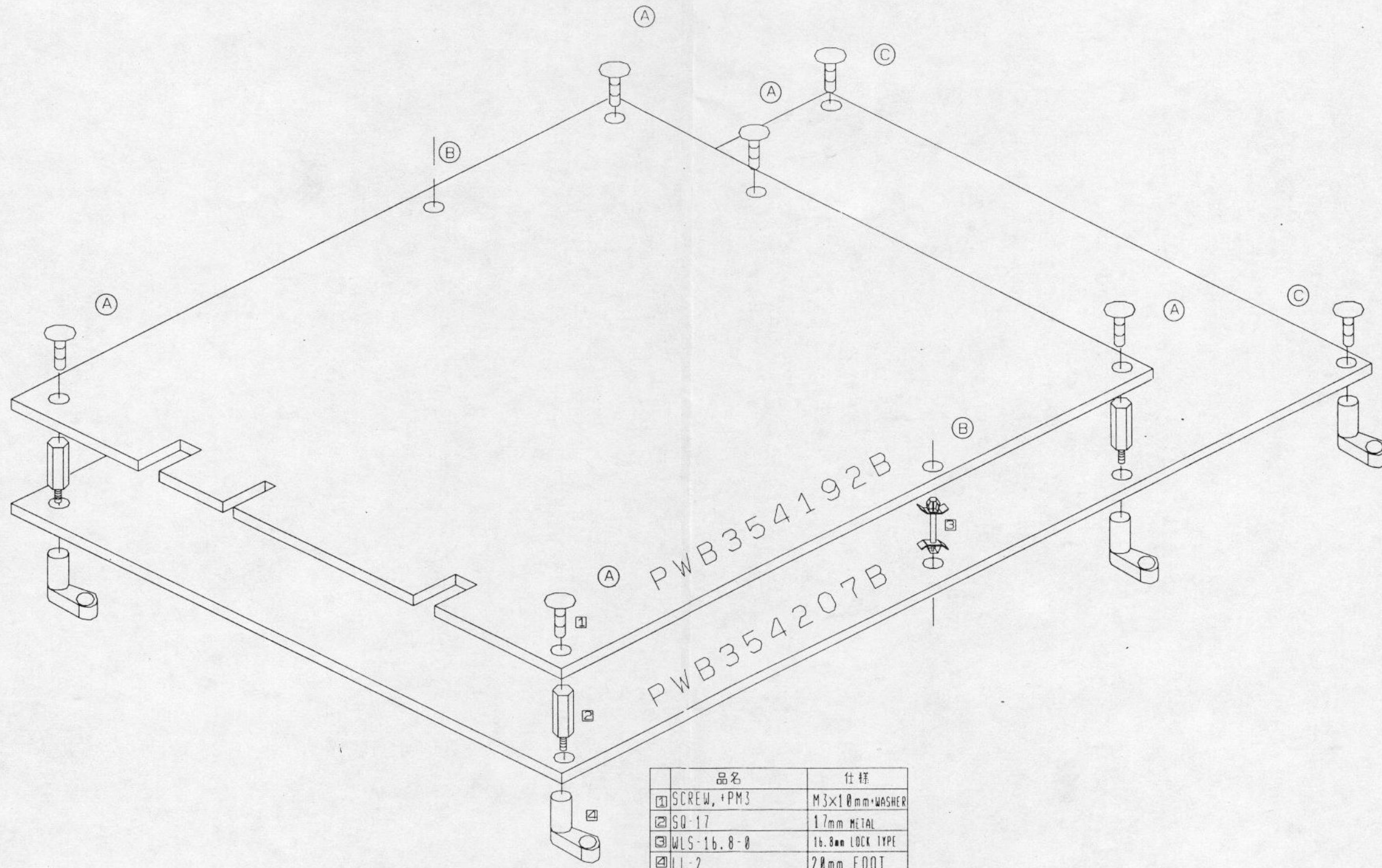

**RACIN' FORCE SUB PCB**



品名	仕様
① SCREW, +PM3	M3×10mm+WASHER
② SQ-17	1.7mm METAL
③ WLS-16.8-0	16.8mm LOCK TYPE
④ LL-2	20mm FOOT

*KONAMI*

KONAMI CO., LTD.

GX250 PCB ASSY DRAWG PWB354192B PWB354207B	
354473	
INTERNAL	P

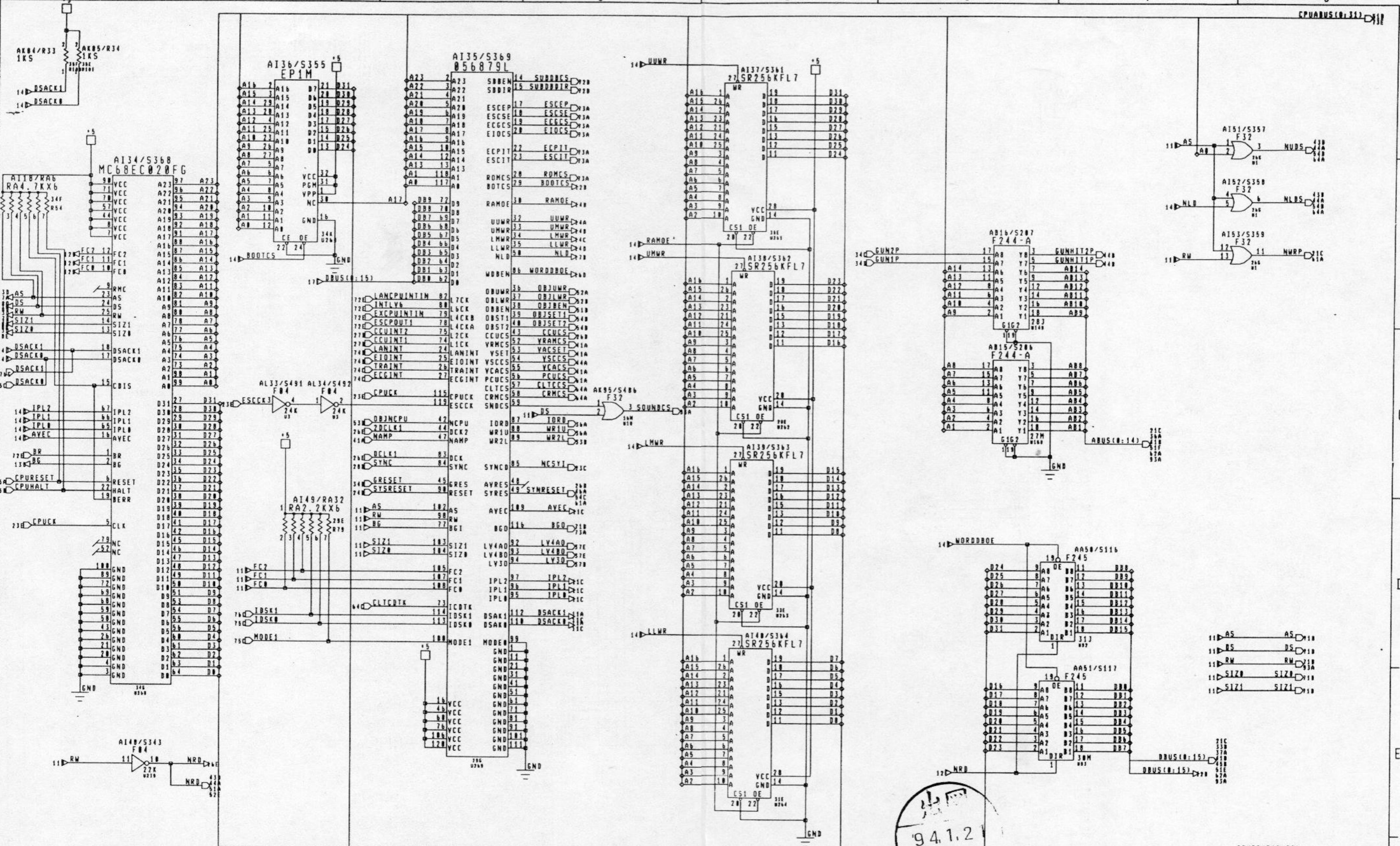

94.1.2  
DRAWING

PROPRIETARY AND CONFIDENTIAL:  
 REPRODUCTION FORBIDDEN WITHOUT THE SPECIFIC WRITTEN PERMISSION OF KONAMI CO., LTD. 4-3-1, TORANOMON, MINATO-KU, TOKYO 105, JAPAN. THIS DRAWING IS ONLY CONDITIONALLY ISSUED. NEITHER RECEIPT NOR POSSESSION OF THIS DRAWING OR ANY OPERATING MANUAL RELATING TO KONAMI'S GAMES OR PRODUCTS CONTAINING THIS DRAWING CONFERS OR TRANSFERS ANY RIGHT IN OR LICENSE TO USE THE PRINTED CIRCUIT BOARDS RELATING TO THIS DRAWING OR OTHER SUBJECT MATTER OF THE DRAWING OR ANY DESIGN OR TECHNICAL INFORMATION SHOWN THEREON. EXCEPT FOR MANUFACTURE BY VENDORS OF KONAMI CO., LTD. AND FOR MANUFACTURE UNDER KONAMI'S WRITTEN LICENSE, NO RIGHT IS GRANTED TO REPRODUCE, MAKE, HAVE MADE, USE OR SELL THIS DRAWING OR THE SUBJECT MATTER THEREOF INCLUDING, WITHOUT LIMITATION, THE PRINTED CIRCUIT BOARD OR OPERATING MANUAL RELATING THERETO, WHATSOEVER, UNLESS BY WRITTEN AGREEMENT WITH OR WRITTEN PERMISSION FROM KONAMI. COPYRIGHT 1992 KONAMI CO., LTD. ALL RIGHTS RESERVED.

KONAMI  
 KONAMI CO., LTD.

DESIGN	Y. MATSUI	TITLE	SCHEMATIC DIAGRAM
DRAW	Y. MATSUI	SUBTITLE	MAIN CPU
CHECK	<i>Shafina</i>	PAGE	1 / 12
APPROVE	<i>H. Ueno</i>	CODE NO.	354471A
SCALE		REG. TYPE	GX300 PWB354192B
TOLERANCE		SECURITY LEVEL	CONFIDENTIAL
DATE	94. 1. 17		



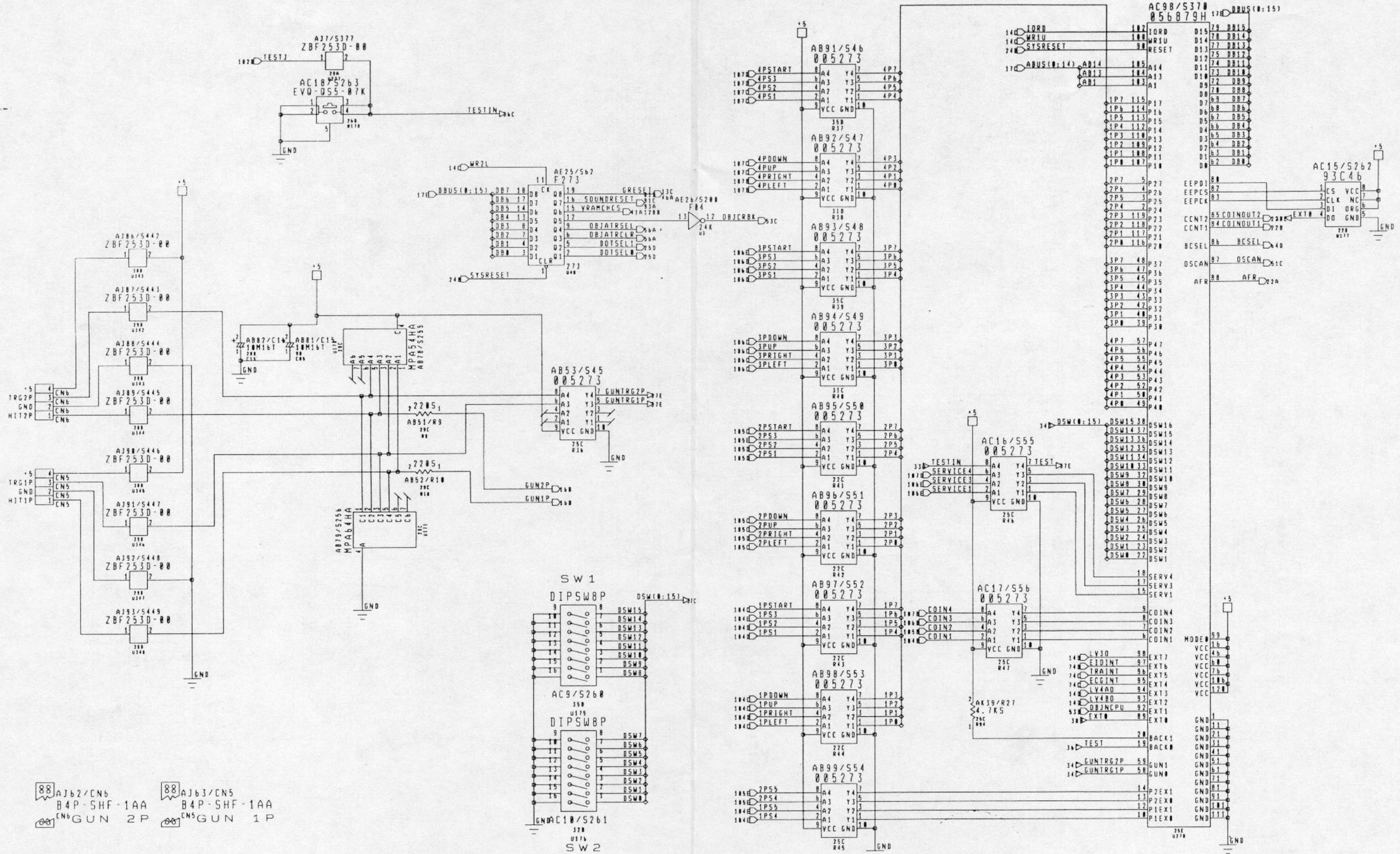

88 AJ62/CN6 B4P-SHF-1AA  
 88 AJ63/CN5 B4P-SHF-1AA  
 CN6 GUN 2P  
 CN5 GUN 1P

**PROPRIETARY AND CONFIDENTIAL:**  
 REPRODUCTION FORBIDDEN WITHOUT THE SPECIFIC WRITTEN PERMISSION OF KONAMI CO., LTD., 4-3-1, TORANOMON, MINATOKU, TOKYO 105, JAPAN. THIS DRAWING IS ONLY CONDITIONALLY ISSUED. NEITHER RECEIPT NOR POSSESSION OF THIS DRAWING OR ANY OPERATING MANUAL RELATING TO KONAMI'S GAMES OR PRODUCTS CONTAINING THIS DRAWING CONFERS OR TRANSFERS ANY RIGHT IN OR LICENSE TO USE THE PRINTED CIRCUIT BOARDS RELATING TO THIS DRAWING OR OTHER SUBJECT MATTER OF THE DRAWING OR ANY DESIGN OR TECHNICAL INFORMATION SHOWN THEREON. EXCEPT FOR MANUFACTURE BY VENDORS OF KONAMI CO., LTD. AND FOR MANUFACTURE UNDER KONAMI'S WRITTEN LICENSE, NO RIGHT IS GRANTED TO REPRODUCE, MAKE, HAVE MADE, USE OR SELL THIS DRAWING OR THE SUBJECT MATTER THEREOF INCLUDING, WITHOUT LIMITATION, THE PRINTED CIRCUIT BOARD OR OPERATING MANUAL RELATING THERE TO, WHATSOEVER, UNLESS BY WRITTEN AGREEMENT WITH OR WRITTEN PERMISSION FROM KONAMI. COPYRIGHT 1992 KONAMI CO., LTD. ALL RIGHTS RESERVED.



DRAWING	DESIGN	Y. MATSU	TITLE	SCHEMATIC DIAGRAM
	DRAW	Y. MATSU	SUBTITLE	10
	CHECK	<i>[Signature]</i>	PAGE	3/12
	APPROVE	<i>[Signature]</i>	CODE NO.	354471A
	SCALE		REG. TYPE	GX300 PWB354192B
	TOLERANCE		SECURITY LEVEL	CONFIDENTIAL
	DATE	94. 3. 17		

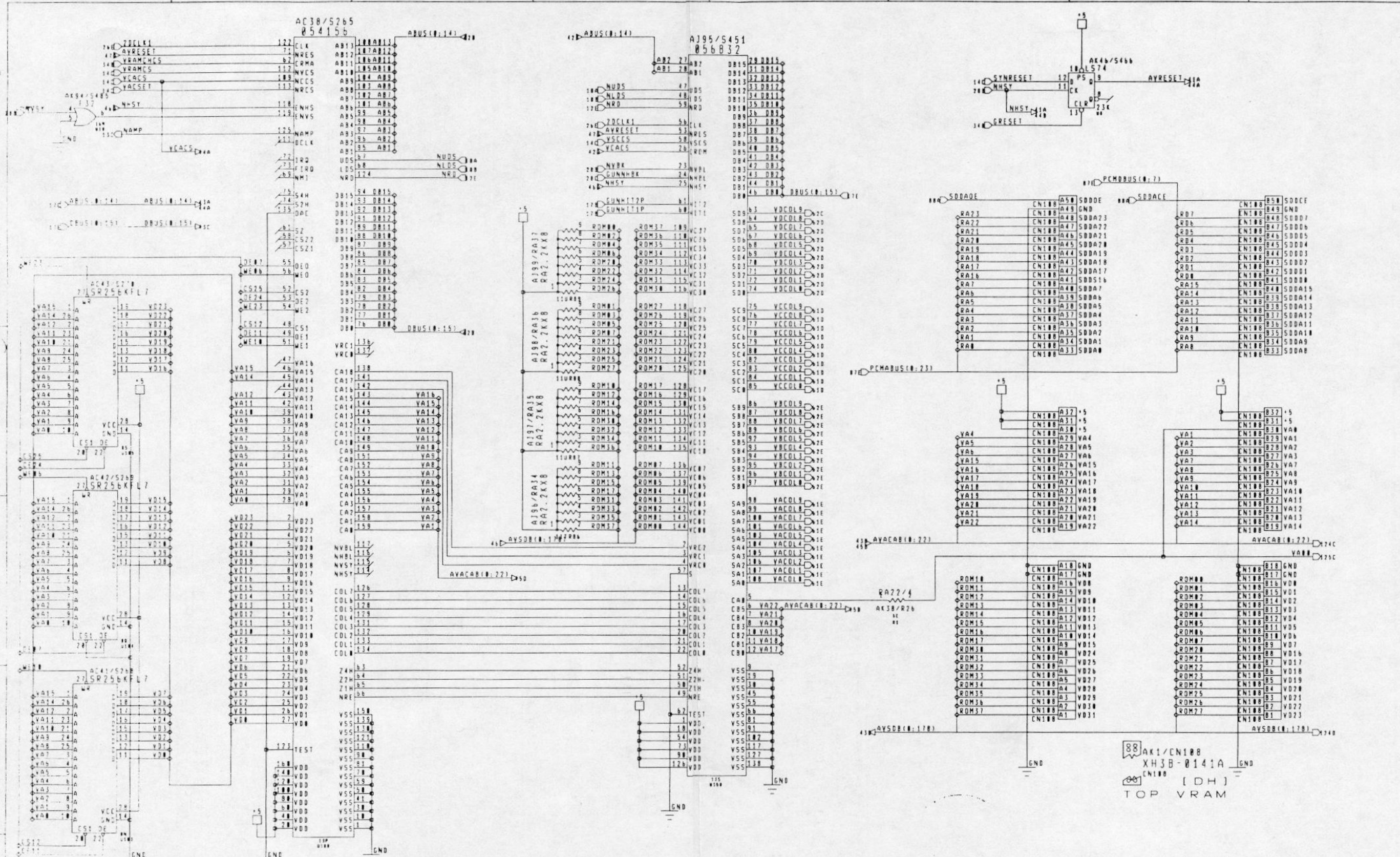

PROPRIETARY AND CONFIDENTIAL:  
 REPRODUCTION FORBIDDEN WITHOUT THE SPECIFIC WRITTEN PERMISSION OF KONAMI CO., LTD., 4-3-1,  
 TORANOMON, MINATO-KU, TOKYO 106, JAPAN. THIS DRAWING IS ONLY CONDITIONALLY ISSUED. NEITHER  
 RECEIPT NOR POSSESSION OF THIS DRAWING OR ANY OPERATING MANUAL RELATING TO KONAMI'S GAMES OR PRODUCTS  
 CONTAINING THIS DRAWING CONFERS OR TRANSFERS ANY RIGHT IN OR LICENSE TO USE THE PRINTED CIRCUIT BOARDS  
 RELATING TO THIS DRAWING OR OTHER SUBJECT MATTER OF THE DRAWING OR ANY DESIGN OR TECHNICAL INFORMATION  
 SHOWN HEREON, EXCEPT FOR MANUFACTURE BY VENDORS OF KONAMI CO., LTD. AND FOR MANUFACTURE UNDER  
 KONAMI'S WRITTEN LICENSE. NO RIGHT IS GRANTED TO REPRODUCE, MAKE, HAVE MADE, USE OR SELL THIS DRAWING  
 OR THE SUBJECT MATTER THEREOF, INCLUDING, WITHOUT LIMITATION, THE PRINTED CIRCUIT BOARD OR OPERATING  
 MANUALLY RELATING THERETO, WHATSOEVER, UNLESS BY WRITTEN AGREEMENT WITH OR WRITTEN PERMISSION FROM KONAMI  
 CO., LTD. © 1992 KONAMI CO., LTD. ALL RIGHTS RESERVED.



DRAWING	DESIGN	Y. MATSUI	TITLE	SCHEMATIC DIAGRAM
	DRAW	Y. MATSUI	SUBTITLE	AVRAM
	CHECK	<i>[Signature]</i>	PAGE	4/12
	APPROVE	<i>[Signature]</i>	CODE NO.	354471A
	SCALE		REG. TYPE	GX100 PUB954:979
	TOLERANCE		SECURITY LEVEL	RES. CONFIDENTIAL
	DATE	9.3.1.97		



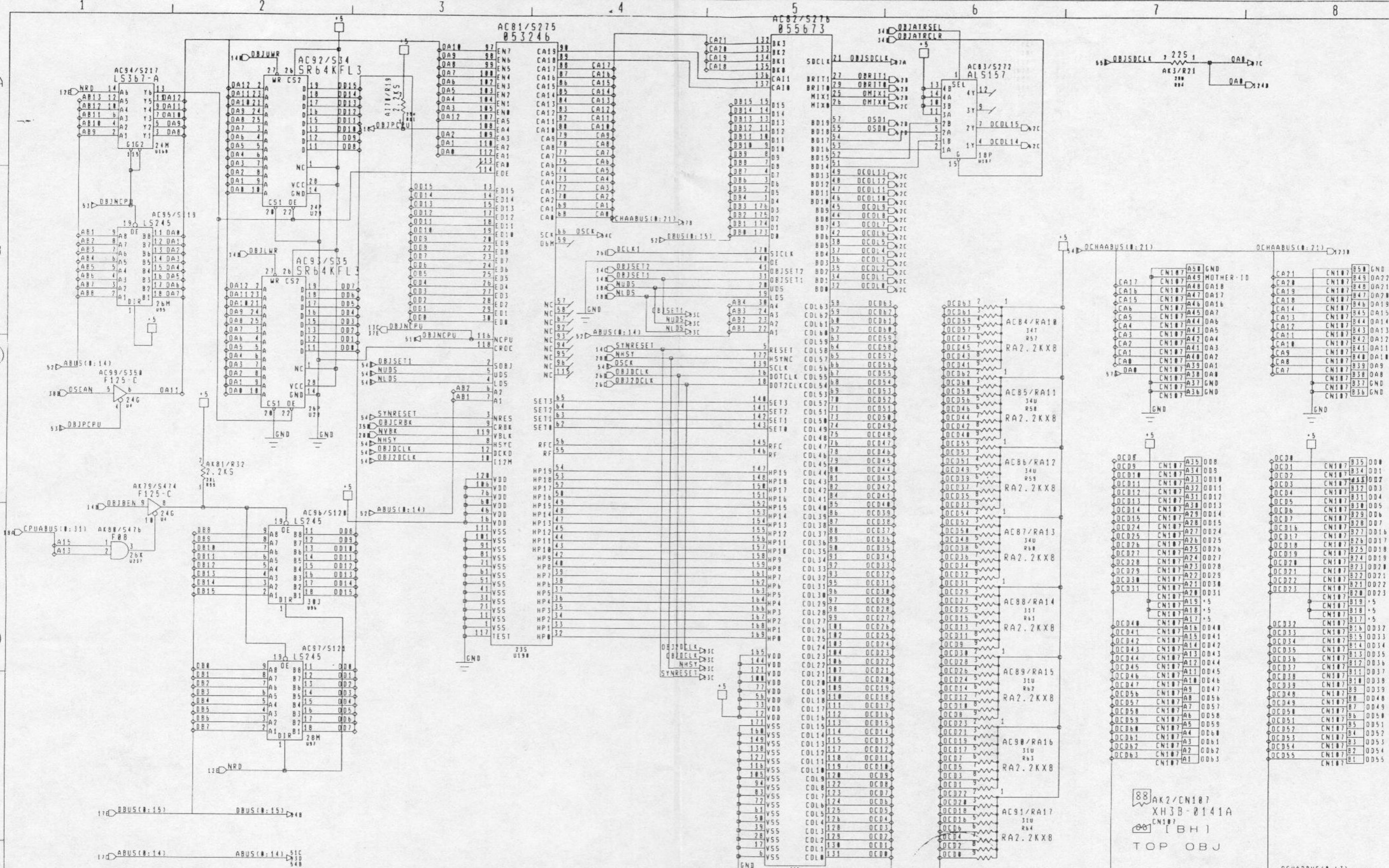

PROPRIETARY AND CONFIDENTIAL:  
 REPRODUCTION FORBIDDEN WITHOUT THE SPECIFIC WRITTEN PERMISSION OF KONAMI CO., LTD. 4-3-1,  
 TORANOMON, MINATOKU, TOKYO 105, JAPAN. THIS DRAWING IS ONLY CONDITIONALLY ISSUED. NEITHER  
 RECEIPT NOR POSSESSION OF THIS DRAWING OR ANY OPERATING MANUAL RELATING TO KONAMI'S GAMES OR PRODUCTS  
 CONTAINING THIS DRAWING CONFERS OR TRANSFERS ANY RIGHT IN OR LICENSE TO USE THE PRINTED CIRCUIT BOARDS  
 SHOWN THEREON. EXCEPT FOR MANUFACTURE BY VENDORS OF KONAMI CO., LTD. AND FOR MANUFACTURE UNDER  
 KONAMI'S WRITTEN LICENSE, NO RIGHT IS GRANTED TO REPRODUCE, MAKE, HAVE MADE, USE OR SELL THIS DRAWING  
 OR THE SUBJECT MATTER HEREOF INCLUDING, WITHOUT LIMITATION, THE PRINTED CIRCUIT BOARD OR OPERATING  
 MANUAL RELATING THERETO, WHATSOEVER, UNLESS BY WRITTEN AGREEMENT WITH OR WRITTEN PERMISSION FROM KONAMI.  
 COPYRIGHT 1992 KONAMI CO., LTD. ALL RIGHTS RESERVED.

KONAMI CO., LTD.

DRAWING	DESIGN	Y. MATSUI	TITLE	SCHEMATIC DIAGRAM
	DRAW	Y. MATSUI	SUBTITLE	OBJ
	CHECK	<i>[Signature]</i>	PAGE	5/12
	APPROVE	<i>[Signature]</i>	CODE NO.	354471A
	SCALE		REG. TYPE	GX300 FWB354192B
	TOLERANCE		SECURITY LEVEL	RES. CONFIDENTIAL
	DATE	94. 1. 17		

88 AK2/CN107  
 XH3B-0141A  
 CN107  
 [BH]  
 TOP OBJ

DCHAABUS(0:63) 235

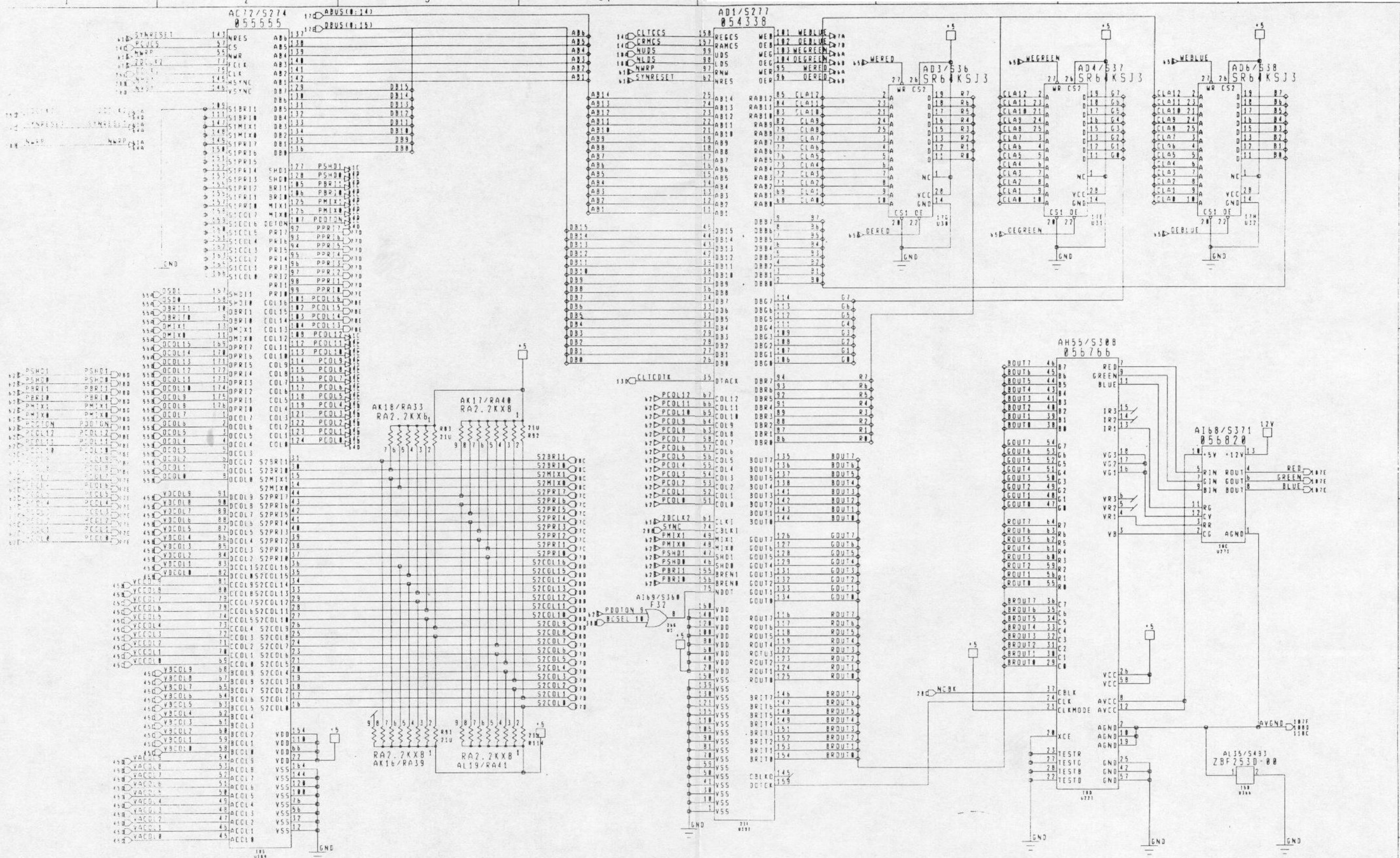

PROPRIETARY AND CONFIDENTIAL:  
 REPRODUCTION PERMITTED WITHOUT THE SPECIFIC WRITTEN PERMISSION OF KONAMI CO., LTD., 4-3-1,  
 TORANOMON, MINATO-KU, TOKYO 105, JAPAN. THIS DRAWING IS ONLY CONDITIONALLY ISSUED. NEITHER  
 RECEIVING NOR POSSESSION OF THIS DRAWING OR ANY OPERATING MANUAL RELATING TO KONAMI'S GAMES OR PRODUCTS  
 CONSTITUTES AN AGREEMENT, LICENSE, OR TRANSFERS ANY RIGHT IN OR LICENSE TO USE THE PRINTED CIRCUIT BOARDS  
 RELATING TO THIS DRAWING OR OTHER SUBJECT MATTER OF THE DRAWING OR ANY DESIGN OR TECHNICAL INFORMATION  
 SHOWN THEREON, EXCEPT FOR MANUFACTURE BY VENDORS OF KONAMI CO., LTD., AND FOR MANUFACTURE UNDER  
 KONAMI'S WRITTEN LICENSE. NO RIGHT IS GRANTED TO REPRODUCE, MAKE, HAVE MADE, USE OR SELL THIS DRAWING  
 OR THE SUBJECT MATTER HEREOF, INCLUDING, WITHOUT LIMITATION, THE PRINTED CIRCUIT BOARD OR OPERATING  
 MANUALS RELATING THEREON, WHATSOEVER, UNLESS BY WRITTEN AGREEMENT WITH OR WRITTEN PERMISSION FROM KONAMI.  
 ©1994 KONAMI CO., LTD. ALL RIGHTS RESERVED.

DRAWING		DESIGN	Y. MATSUI	TITLE	SCHEMATIC DIAGRAM
		DRAW	Y. MATSUI	SUBTITLE	PCU&LIC&V&A&V&H&C
		CHECK	<i>[Signature]</i>	PAGE	6 / 12
		APPROVE	<i>[Signature]</i>	CODE NO.	354471A
		SCALE		REG. INFO	EX100 PWB341523
		TOLERANCE		SECURITY LEVEL	CONFIDENTIAL



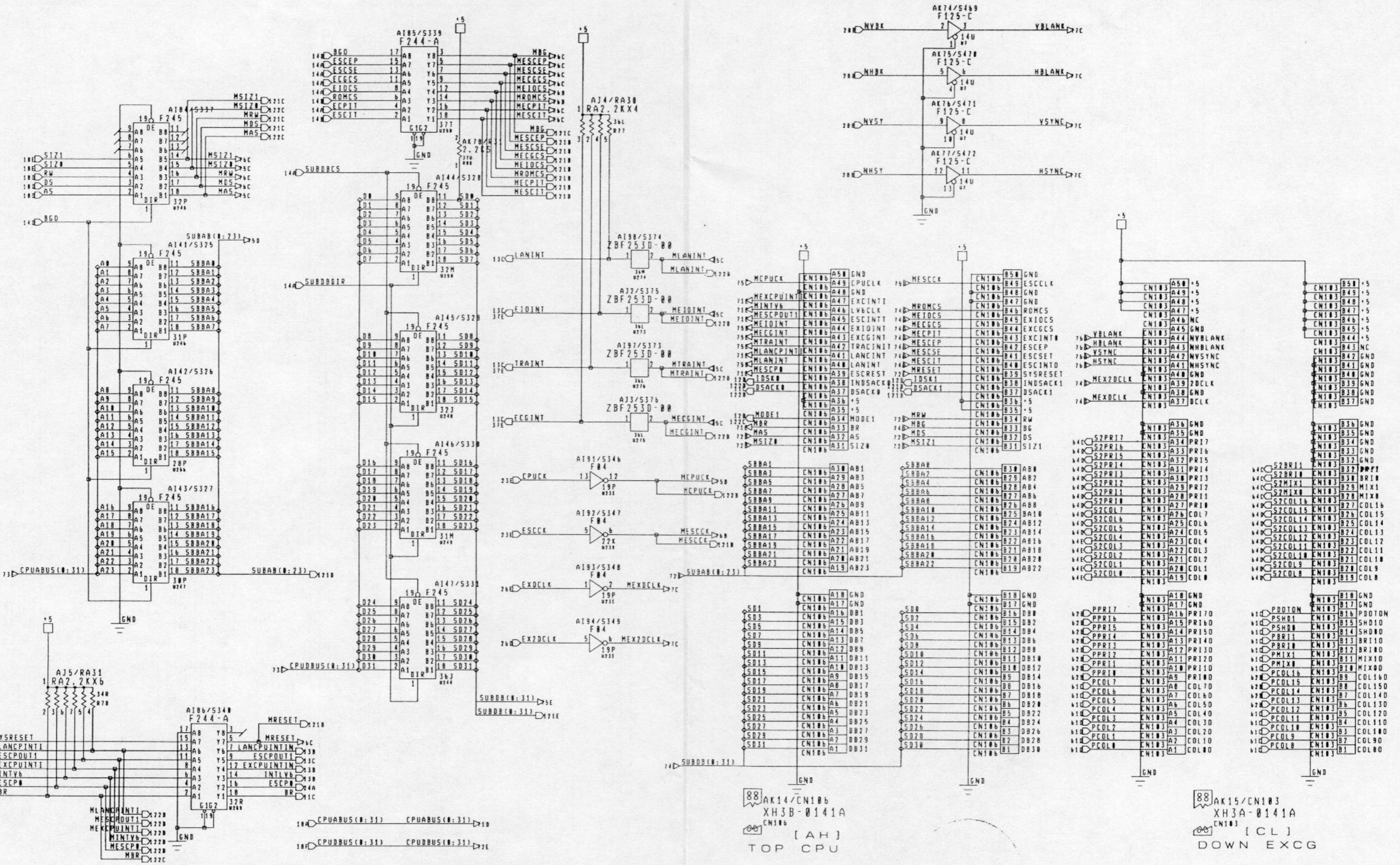

PROPRIETARY AND CONFIDENTIAL.  
 REPRODUCTION FORBIDDEN WITHOUT THE SPECIFIC WRITTEN PERMISSION OF KONAMI CO., LTD. 4-3-1, TORANOMON, MINATOKU, TOKYO 105, JAPAN. THIS DRAWING IS ONLY CONDITIONALLY ISSUED. NEITHER RECEIPT NOR POSSESSION OF THIS DRAWING OR ANY OPERATING MANUAL RELATING TO KONAMI'S GAMES OR PRODUCTS CONTAINING THIS DRAWING CONFERS OR TRANSFERS ANY RIGHT IN OR LICENSE TO USE THE PRINTED CIRCUIT BOARDS RELATING TO THIS DRAWING OR OTHER SUBJECT MATTER OF THE DRAWING OR ANY DESIGN OR TECHNICAL INFORMATION SHOWN THEREON. EXCEPT FOR MANUFACTURE BY VENDORS OF KONAMI CO., LTD. AND FOR MANUFACTURE UNDER KONAMI'S WRITTEN LICENSE, NO RIGHT IS GRANTED TO REPRODUCE, MAKE, HAVE MADE, USE OR SELL THIS DRAWING OR THE SUBJECT MATTER THEREOF INCLUDING, WITHOUT LIMITATION, THE PRINTED CIRCUIT BOARD OR OPERATING MANUAL RELATING THERETO, WHATSOEVER, UNLESS BY WRITTEN AGREEMENT WITH OR WRITTEN PERMISSION FROM KONAMI. COPYRIGHT 1992 KONAMI CO., LTD. ALL RIGHTS RESERVED.

**KONAMI**  
 KONAMI CO., LTD.

DRAWING

DESIGN	Y. MATSUI	TITLE	SCHEMATIC DIAGRAM
DRAW	Y. MATSUI	SUBTITLE	EXBUS/CONNECTOR
CHECK	<i>[Signature]</i>	PAGE	7 / 12
APPROVE	<i>[Signature]</i>	CODE NO.	354471A
SCALE		REG. TYPE	GX300 PWB354192B
TOLERANCE		SECURITY LEVEL	CONFIDENTIAL
DATE	94. 1. 17		

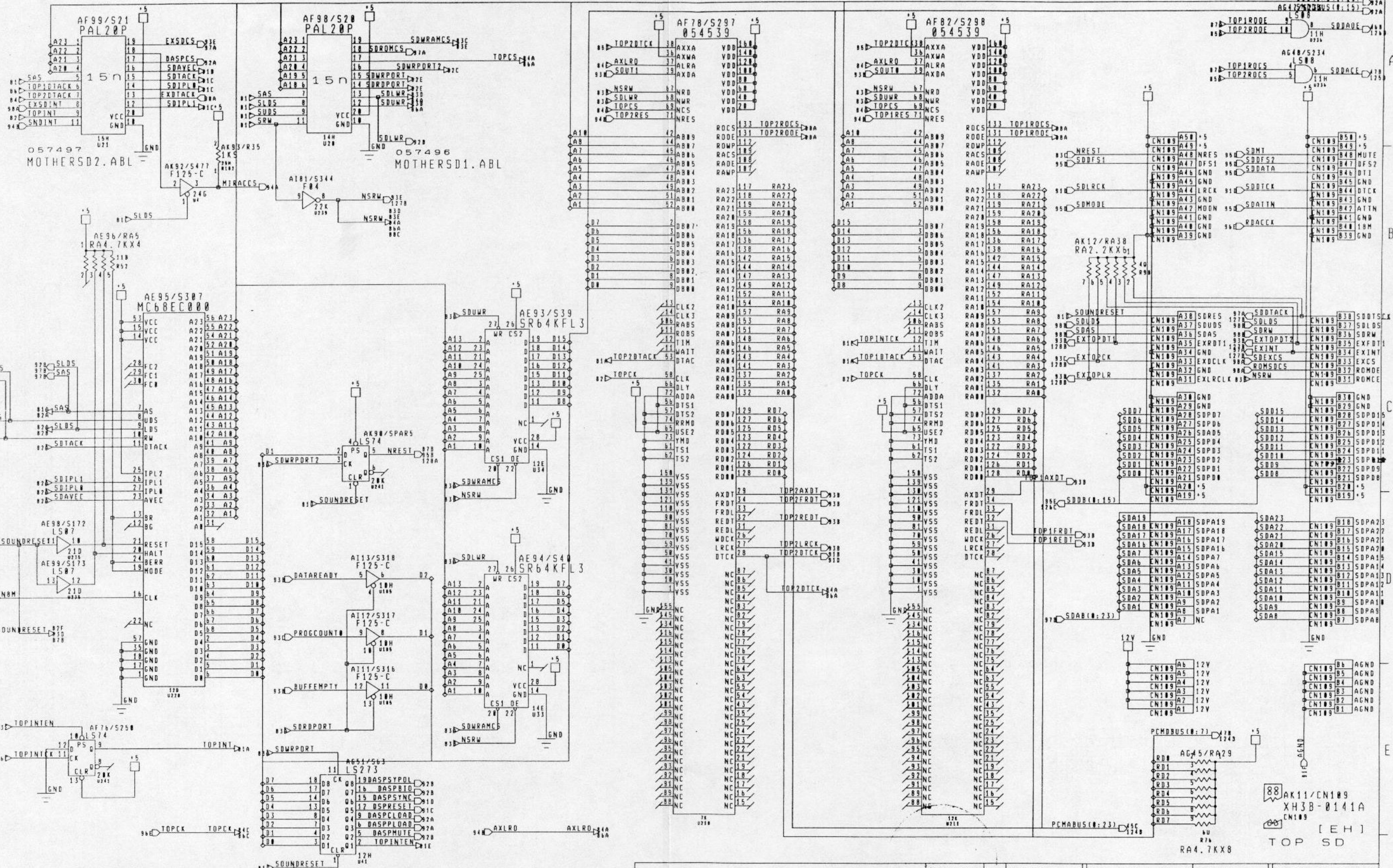

PROPRIETARY AND CONFIDENTIAL:  
 REPRODUCTION FORBIDDEN WITHOUT THE SPECIFIC WRITTEN PERMISSION OF KONAMI CO., LTD., 4-3-1, TORANOMON, MINATO-KU, TOKYO 105, JAPAN. THIS DRAWING IS ONLY CONDITIONALLY ISSUED. NEITHER RECEIPT NOR POSSESSION OF THIS DRAWING OR ANY OPERATING MANUAL RELATING TO KONAMI'S GAMES OR PRODUCTS CONTAINING THIS DRAWING CONFERS OR TRANSFERS ANY RIGHT IN OR LICENSE TO USE THE PRINTED CIRCUIT BOARDS RELATING TO THIS DRAWING OR OTHER SUBJECT MATTER OF THE DRAWING OR ANY DESIGN OR TECHNICAL INFORMATION SHOWN THEREON. EXCEPT FOR MANUFACTURE BY VENDORS OF KONAMI CO., LTD. AND FOR MANUFACTURE UNDER KONAMI'S WRITTEN LICENSE, NO RIGHT IS GRANTED TO REPRODUCE, MAKE, HAVE MADE, USE OR SELL THIS DRAWING OR THE SUBJECT MATTER THEREOF INCLUDING, WITHOUT LIMITATION, THE PRINTED CIRCUIT BOARD OR OPERATING MANUAL RELATING THERETO, WHATSOEVER, UNLESS BY WRITTEN AGREEMENT WITH OR WRITTEN PERMISSION FROM KONAMI. COPYRIGHT 1992 KONAMI CO., LTD. ALL RIGHTS RESERVED.

KONAMI

KONAMI CO., LTD.

DESIGN	Y. MATSUI	TITLE	SCHEMATIC DIAGRAM
DRAW	Y. MATSUI	SUBTITLE	SD CPU & TOP
CHECK	<i>[Signature]</i>	PAGE	B/12
APPROVE	<i>[Signature]</i>	CODE NO.	354471A
SCALE		REG. TYPE	GX300 PWB354192B
TOLERANCE		SECURITY LEVEL	RES. CONFIDENTIAL
DATE	94.1.17		

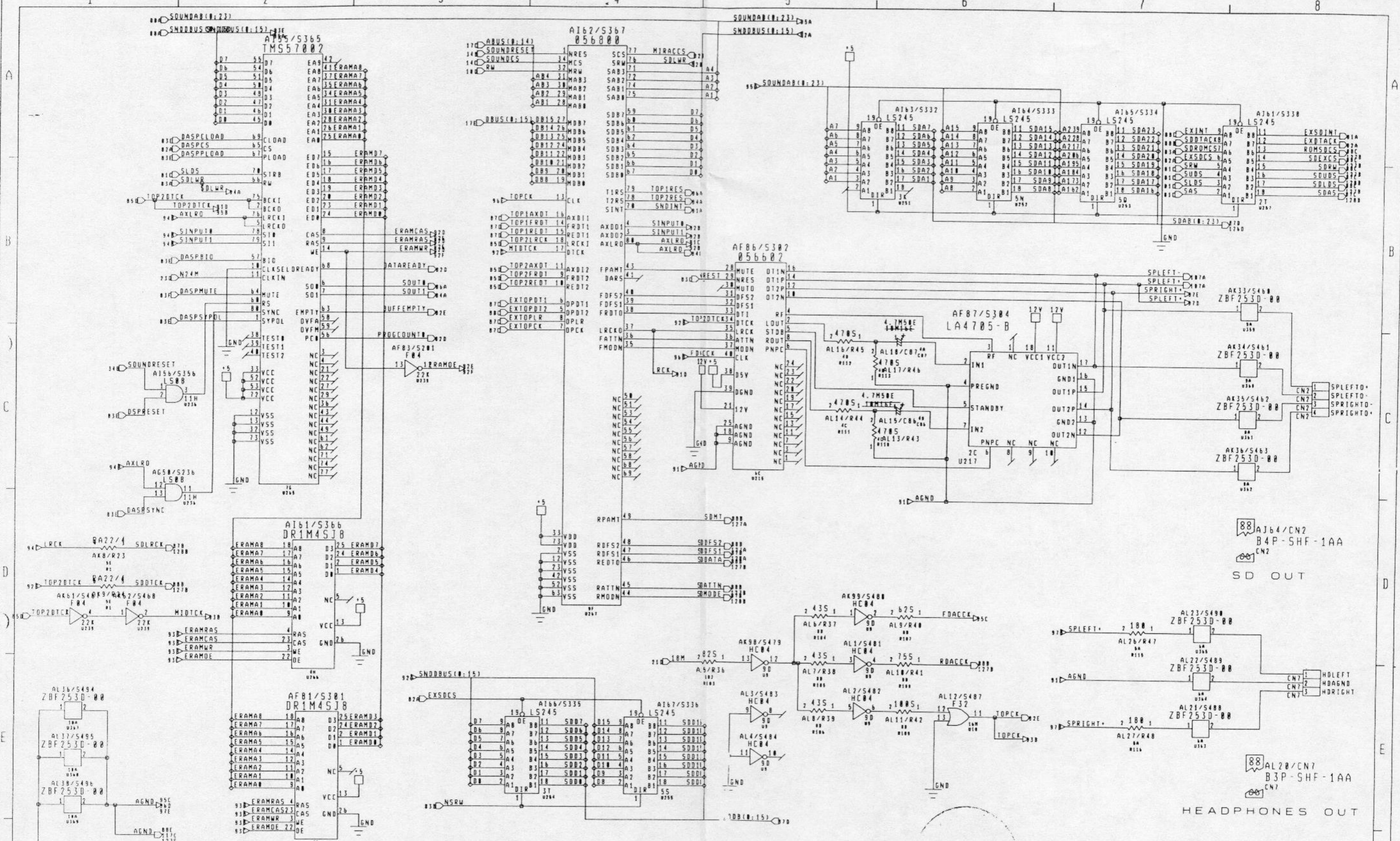

PROPRIETARY AND CONFIDENTIAL:  
 REPRODUCTION FORBIDDEN WITHOUT THE SPECIFIC WRITTEN PERMISSION OF KONAMI CO., LTD., 4-3-1, TORANOMON, MINATOKU, TOKYO 105, JAPAN. THIS DRAWING IS ONLY CONDITIONALLY ISSUED. NEITHER RECEIPT NOR POSSESSION OF THIS DRAWING OR ANY OPERATING MANUAL RELATING TO KONAMI'S GAMES OR PRODUCTS CONTAINING THIS DRAWING CONFERS OR TRANSFERS ANY RIGHT IN OR LICENSE TO USE THE PRINTED CIRCUIT BOARDS RELATING TO THIS DRAWING OR OTHER SUBJECT MATTER OF THE DRAWING OR ANY DESIGN OR TECHNICAL INFORMATION SHOWN THEREON, EXCEPT FOR MANUFACTURE BY VENDORS OF KONAMI CO., LTD. AND FOR MANUFACTURE UNDER KONAMI'S WRITTEN LICENSE. NO RIGHT IS GRANTED TO REPRODUCE, MAKE, HAVE MADE, USE OR SELL THIS DRAWING OR THE SUBJECT MATTER THEREOF INCLUDING, WITHOUT LIMITATION, THE PRINTED CIRCUIT BOARD OR OPERATING MANUAL RELATING THERETO, WHATSOEVER, UNLESS BY WRITTEN AGREEMENT WITH OR WRITTEN PERMISSION FROM KONAMI. COPYRIGHT 1997 KONAMI CO., LTD. ALL RIGHTS RESERVED.



DRAWING		DESIGN	Y. MATSU	TITLE	SCHEMATIC DIAGRAM
DRAW		Y. MATSU		SUBTITLE	DASPMIRAC&SHIC
CHECK		<i>[Signature]</i>		PAGE	9/12
APPROVE		<i>[Signature]</i>		CODE NO.	354471A
SCALE				REG. TYPE	CX300 PW354192B
TOLERANCE				SECURITY LEVEL	CONFIDENTIAL
DATE			94. 1. 17		

88 AJ9/CN1  
JAMMA  
CN1

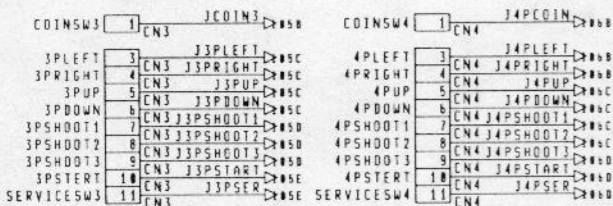
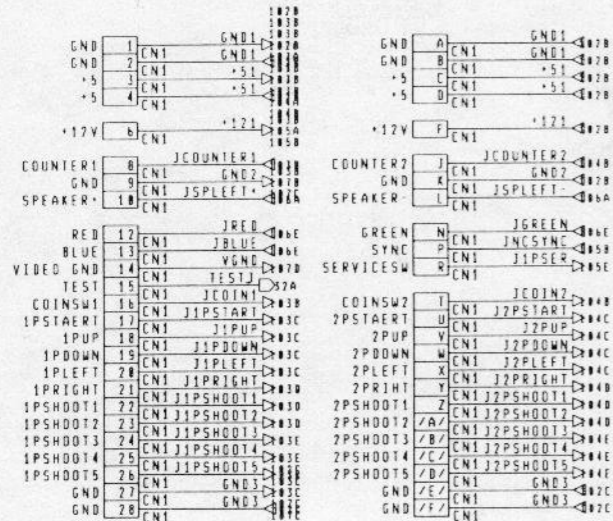

88 AJ11/CN4  
B15P-SHF-1AA  
CN4

4P



このメッキ面にショート

PROPRIETARY AND CONFIDENTIAL:  
REPRODUCTION FORBIDDEN WITHOUT THE SPECIFIC WRITTEN PERMISSION OF KONAMI CO., LTD., 4-3-1, TORANOMON, MINATO-KU, TOKYO 105, JAPAN. THIS DRAWING IS ONLY CONDITIONALLY ISSUED. NEITHER RECEIPT NOR POSSESSION OF THIS DRAWING OR ANY OPERATING MANUAL RELATING TO KONAMI'S GAMES OR PRODUCTS CONTAINING THIS DRAWING CONFERS OR TRANSFERS ANY RIGHT IN OR LICENSE TO USE THE PRINTED CIRCUIT BOARDS RELATING TO THIS DRAWING OR OTHER SUBJECT MATTER OF THE DRAWING OR ANY DESIGN OR TECHNICAL INFORMATION SHOWN THEREON. EXCEPT FOR MANUFACTURE BY VENDORS OF KONAMI CO., LTD. AND FOR MANUFACTURE UNDER KONAMI'S WRITTEN LICENSE, NO RIGHT IS GRANTED TO REPRODUCE, MAKE, HAVE MADE, USE OR SELL THIS DRAWING OR THE SUBJECT MATTER THEREOF INCLUDING, WITHOUT LIMITATION, THE PRINTED CIRCUIT BOARD OR OPERATING MANUAL RELATING THERETO, WHATSOEVER, UNLESS BY WRITTEN AGREEMENT WITH OR WRITTEN PERMISSION FROM KONAMI. COPYRIGHT 1992 KONAMI CO., LTD. ALL RIGHTS RESERVED.

KONAMI  
KONAMI CO., LTD.

DRAWING	DESIGN	Y. MATSUI	TITLE	SCHEMATIC DIAGRAM
	DRAW	Y. MATSUI	SUBTITLE	JAMMA&3P&4P
	CHECK	<i>Y. Matsui</i>	PAGE	10/12
	APPROVE	<i>Y. Matsui</i>	CODE NO.	354471A
	SCALE		REG. TYPE	GS300 P&B354:923
	TOLERANCE		SECURITY LEVEL	CONFIDENTIAL
	DATE	94. 1. 17		

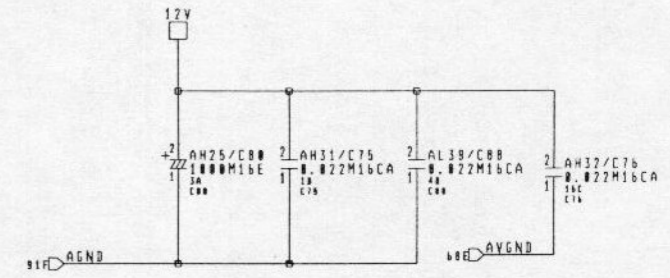
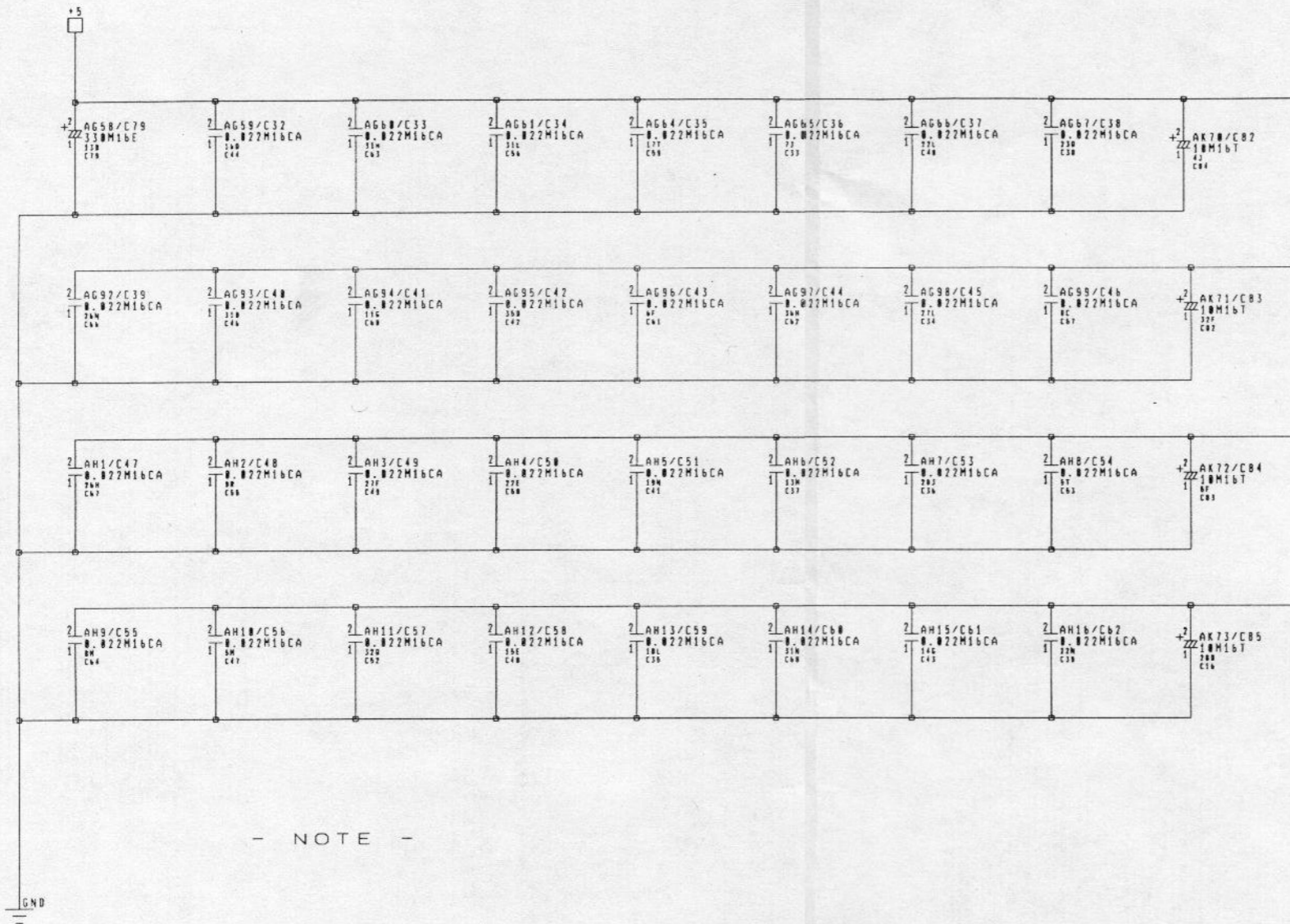

- NOTE -

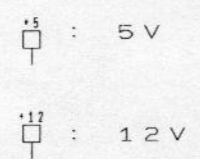

- 1000M16E \* 1000 $\mu$ F Electrolytic capacitor
- 330M16E \* 330 $\mu$ F Electrolytic capacitor
- 4.7M50E \* 4.7 $\mu$ F Tantalum capacitor
- 0.1M25CA \* 0.1 $\mu$ F Ceramic capacitor (AXIAL LEAD TYPE)
- 0.022M25CA \* 0.022 $\mu$ F Ceramic capacitor (AXIAL LEAD TYPE)

PROPRIETARY AND CONFIDENTIAL:  
REPRODUCTION FORBIDDEN WITHOUT THE SPECIFIC WRITTEN PERMISSION OF KONAMI CO., LTD., 4-3-1, TORANOMON, MINATOKU, TOKYO 105, JAPAN. THIS DRAWING IS ONLY CONDITIONALLY ISSUED. NEITHER RECEIPT NOR POSSESSION OF THIS DRAWING OR ANY OPERATING MANUAL RELATING TO KONAMI'S GAMES OR PRODUCTS CONTAINING THIS DRAWING CONFERS OR TRANSFERS ANY RIGHT IN OR LICENSE TO USE THE PRINTED CIRCUIT BOARDS RELATING TO THIS DRAWING OR OTHER SUBJECT MATTER OF THE DRAWING OR ANY DESIGN OR TECHNICAL INFORMATION SHOWN THEREON, EXCEPT FOR MANUFACTURE BY VENDORS OF KONAMI CO., LTD. AND FOR MANUFACTURE UNDER KONAMI'S WRITTEN LICENSE. NO RIGHT IS GRANTED TO REPRODUCE, MAKE, HAVE MADE, USE OR SELL THIS DRAWING OR THE SUBJECT MATTER THEREOF INCLUDING, WITHOUT LIMITATION, THE PRINTED CIRCUIT BOARD OR OPERATING MANUAL RELATING THERETO, WHATSOEVER, UNLESS BY WRITTEN AGREEMENT WITH OR WRITTEN PERMISSION FROM KONAMI. COPYRIGHT 1997 KONAMI CO., LTD. ALL RIGHTS RESERVED.



DRAWING	DESIGN	Y. MATSUI	TITLE	SCHEMATIC DIAGRAM
	DRAW	Y. MATSU	SUBTITLE	PASS CON
	CHECK	<i>[Signature]</i>	PAGE	11/12
	APPROVE	<i>[Signature]</i>	CODE NO.	354471A
	SCALE		REG. TYPE	GX320 PWB354192B
	TOLERANCE		SECURITY LEVEL	CONFIDENTIAL
	DATE	94. 1. 17		

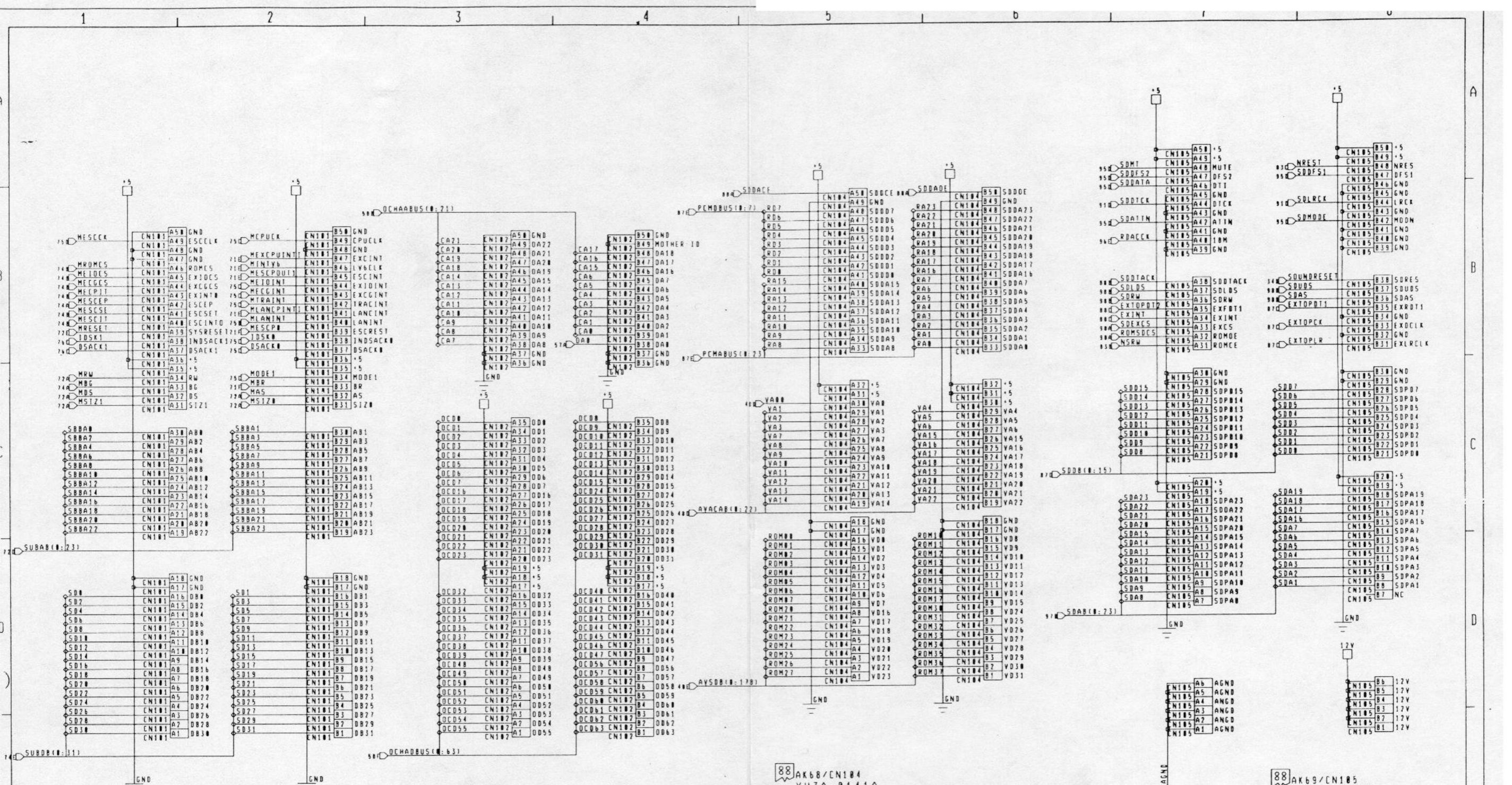

88 AK63/CN101  
XH3A-0141A  
CN101  
DOWN CPU  
[AL]

88 AK67/CN102  
XH3A-0141A  
CN102  
DOWN OBJ  
[BL]

88 AK68/CN104  
XH3A-0141A  
CN104  
DOWN VRAM  
[DL]

88 AK69/CN105  
XH3A-0141A  
CN105  
DOWN SD  
[EL]

PROPRIETARY AND CONFIDENTIAL:  
REPRODUCTION FORBIDDEN WITHOUT THE SPECIFIC WRITTEN PERMISSION OF KONAMI CO., LTD., 4-3-1,  
TORANOMON, MINATO-KU, TOKYO 105, JAPAN. THIS DRAWING IS ONLY CONDITIONALLY ISSUED. NEITHER  
RECEIPT NOR POSSESSION OF THIS DRAWING OR ANY OPERATING MANUAL RELATING TO KONAMI'S GAMES OR PRODUCTS  
CONTAINING THIS DRAWING CONFERS OR TRANSFERS ANY RIGHT IN OR LICENSE TO USE THE PRINTED CIRCUIT BOARDS  
RELATING TO THIS DRAWING OR OTHER SUBJECT MATTER OF THE DRAWING OR ANY DESIGN OR TECHNICAL INFORMATION  
SHOWN THEREON. EXCEPT FOR MANUFACTURE BY VENDORS OF KONAMI CO., LTD. AND FOR MANUFACTURE UNDER  
KONAMI'S WRITTEN LICENSE, NO RIGHT IS GRANTED TO REPRODUCE, MAKE, HAVE MADE, USE OR SELL THIS DRAWING  
OR THE SUBJECT MATTER THEREOF INCLUDING, WITHOUT LIMITATION, THE PRINTED CIRCUIT BOARD OR OPERATING  
MANUAL RELATING THEREOF, WHATSOEVER, UNLESS BY WRITTEN AGREEMENT WITH OR WRITTEN PERMISSION FROM KONAMI  
COPYRIGHT 1992 KONAMI CO., LTD. ALL RIGHTS RESERVED.

**KONAMI**  
KONAMI CO., LTD.

DRAWING	DESIGN	Y. MATSUI	TITLE	SCHEMATIC DIAGRAM
	DRAW	Y. MATSUI	SUBTITLE	CONNECTOR
	CHECK	<i>[Signature]</i>	PAGE	12 / 12
	APPROVE	<i>[Signature]</i>	CODE NO.	354471A
	SCALE		REL. TYPE	0X300 PUB354192B
	TOLERANCE		SECURITY LEVEL	(CONFIDENTIAL)
	DATE	94. 1. 17		





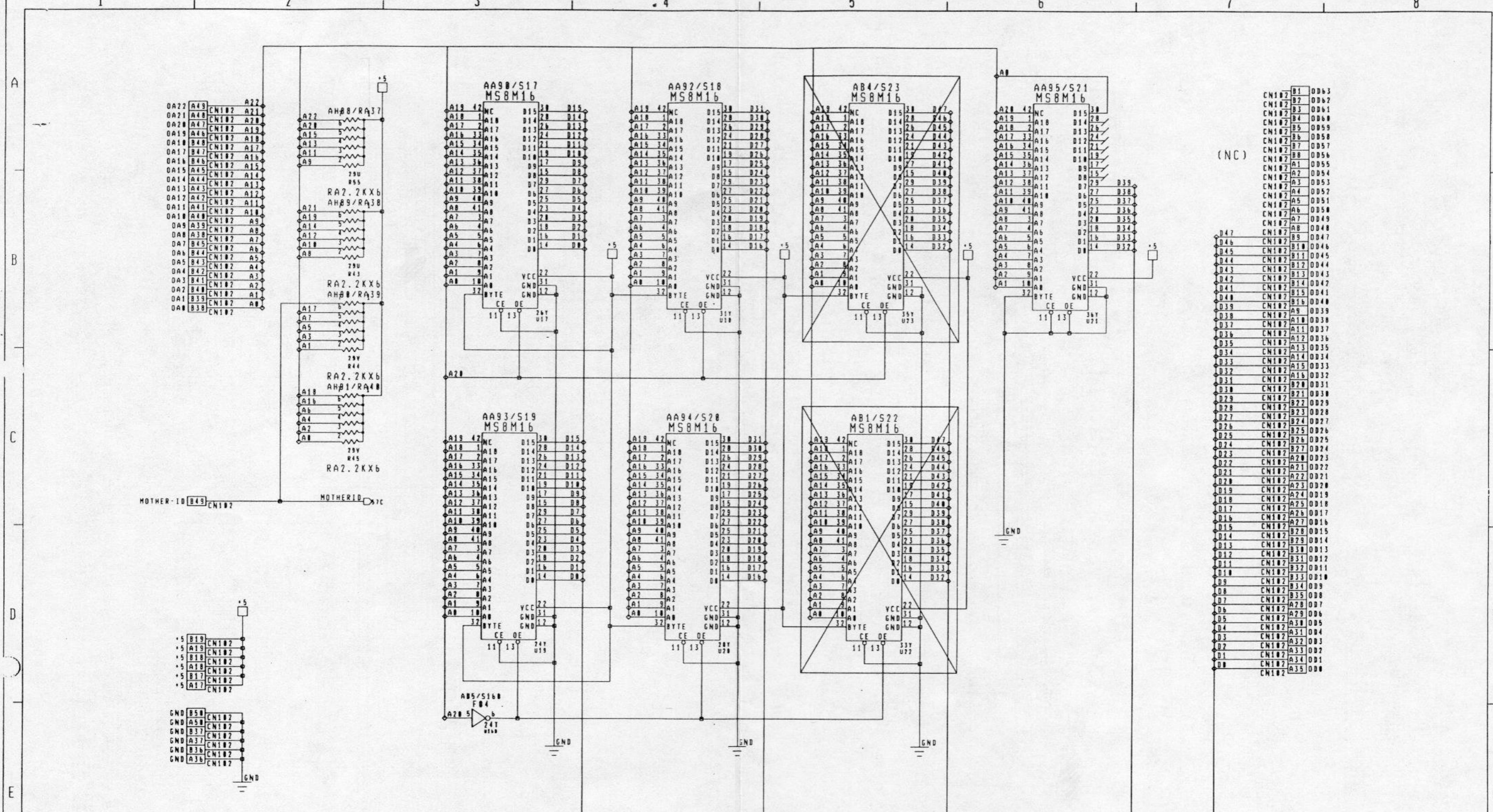

MOTHER ID [B49] CN102

MOTHER ID 7C

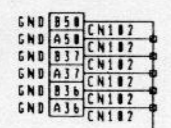
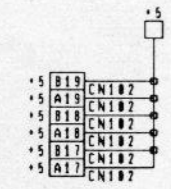

88 AG77/CN102  
 XH3A-0141A  
 CN102

**PROPRIETARY AND CONFIDENTIAL:**  
 REPRODUCTION FORBIDDEN WITHOUT THE SPECIFIC WRITTEN PERMISSION OF KONAMI CO., LTD., 4-3-1, TORANOMON, MINATOKU, TOKYO 105, JAPAN. THIS DRAWING IS ONLY CONDITIONALLY ISSUED. NEITHER RECEIPT NOR POSSESSION OF THIS DRAWING OR ANY OPERATING MANUAL RELATIVE TO KONAMI'S GAMES OR PRODUCTS CONTAINING THIS DRAWING CONFERS OR TRANSFERS ANY RIGHT IN OR LICENSE TO USE THE PRINTED CIRCUIT BOARDS RELATING TO THIS DRAWING OR OTHER SUBJECT MATTER OF THE DRAWING OR ANY DESIGN OR TECHNICAL INFORMATION SHOWN THEREON. EXCEPT FOR MANUFACTURE BY VENDORS OF KONAMI CO., LTD. AND FOR MANUFACTURE UNDER KONAMI'S WRITTEN LICENSE, NO RIGHT IS GRANTED TO REPRODUCE, MAKE, HAVE MADE, USE OR SELL THIS DRAWING OR THE SUBJECT MATTER THEREOF INCLUDING, WITHOUT LIMITATION, THE PRINTED CIRCUIT BOARD OR OPERATING MANUAL RELATING THERETO, WHATSOEVER, UNLESS BY WRITTEN AGREEMENT WITH OR WRITTEN PERMISSION FROM KONAMI. COPYRIGHT 1992 KONAMI CO., LTD. ALL RIGHTS RESERVED.

**KONAMI**

KONAMI CO., LTD.



DESIGN	M. NAGATOMI	TITLE	SCHEMATIC DIAGRAM
DRAW	Y. MATSUI	SUBTITLE	CN2 (OBJ)
CHECK	<i>[Signature]</i>	PAGE	2 / 13
APPROVE	<i>[Signature]</i>	CODE NO.	354472A
SCALE		REG. TYPE	GX250 PWB3542178
TOLERANCE		SECURITY LEVEL	CONFIDENTIAL
DATE	94. 1. 18		

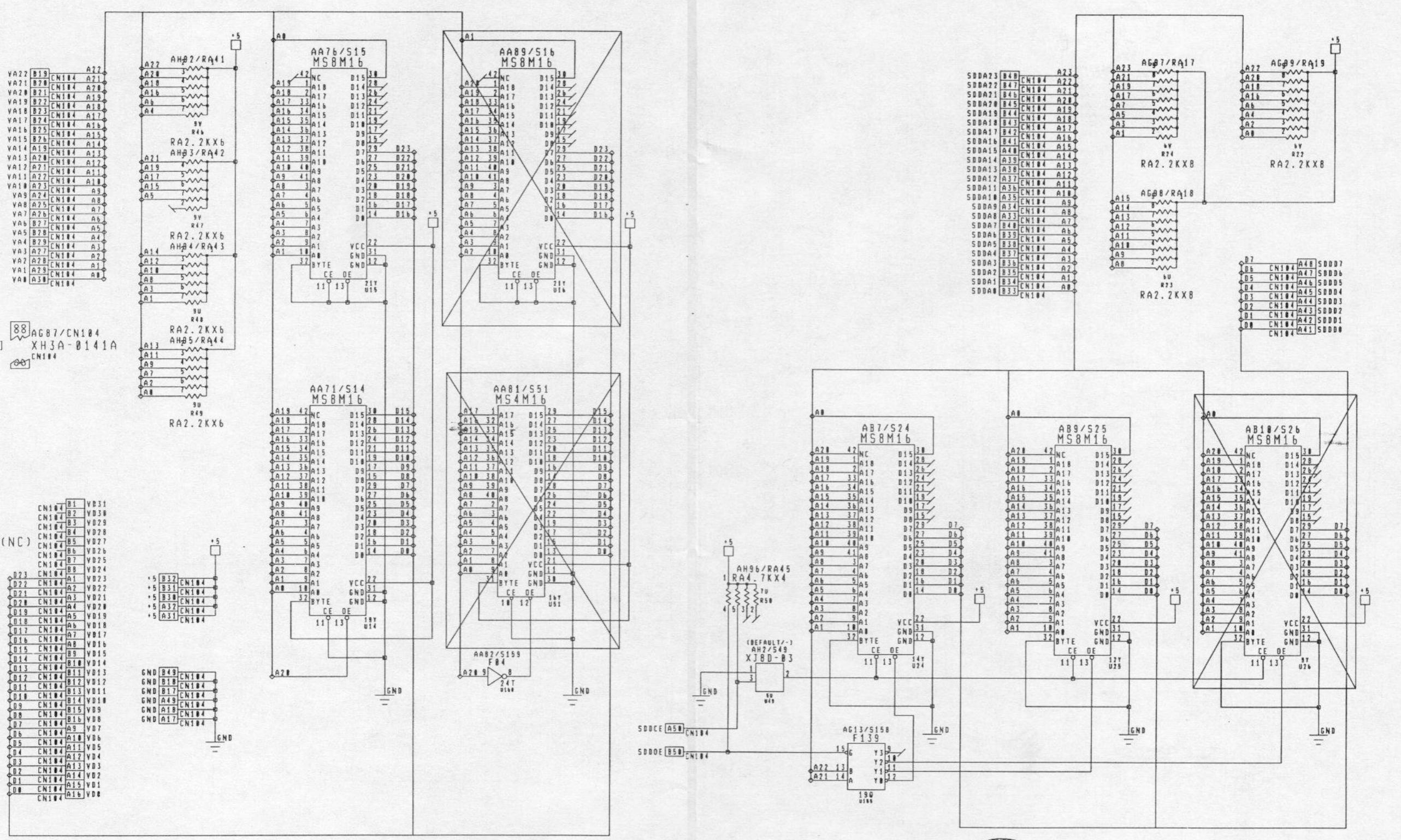

PROPRIETARY AND CONFIDENTIAL:  
 REPRODUCTION FORBIDDEN WITHOUT THE SPECIFIC WRITTEN PERMISSION OF KONAMI CO., LTD., 4-3-1, TORANOMON, MINATOKU, TOKYO 105, JAPAN. THIS DRAWING IS ONLY CONDITIONALLY ISSUED. NEITHER RECEIPT NOR POSSESSION OF THIS DRAWING OR ANY OPERATING MANUAL RELATING TO KONAMI'S GAMES OR PRODUCTS CONTAINING THIS DRAWING CONFERS OR TRANSFERS ANY RIGHT IN OR LICENSE TO USE THE PRINTED CIRCUIT BOARDS RELATING TO THIS DRAWING OR OTHER SUBJECT MATTER OF THE DRAWING OR ANY DESIGN OR TECHNICAL INFORMATION SHOWN THEREON, EXCEPT FOR MANUFACTURE BY VENDORS OF KONAMI CO., LTD. AND FOR MANUFACTURE UNDER KONAMI'S WRITTEN LICENSE. NO RIGHT IS GRANTED TO REPRODUCE, MAKE, HAVE MADE, USE OR SELL THIS DRAWING OR THE SUBJECT MATTER THEREOF INCLUDING, WITHOUT LIMITATION, THE PRINTED CIRCUIT BOARD OR OPERATING MANUAL RELATING THERE TO, WHATSOEVER, UNLESS BY WRITTEN AGREEMENT WITH OR WRITTEN PERMISSION FROM KONAMI. COPYRIGHT 1992 KONAMI CO., LTD. ALL RIGHTS RESERVED.

**KONAMI**  
 KONAMI CO., LTD.

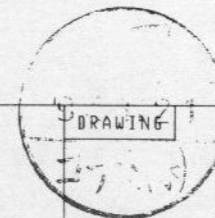

DESIGN	M. NAGATOMI	TITLE	SCHEMATIC DIAGRAM
DRAW	Y. MATSUI	SUBTITLE	CN3 (VRAM, PCM)
CHECK	<i>Y. Matsui</i>	PAGE	3/13
APPROVE	<i>M. Nagatomi</i>	CODE NO.	354472A
SCALE		REG. TYPE	GX250 PWB354207B
TOLERANCE		SECURITY LEVEL	CONFIDENTIAL
DATE	94. 1. 18		

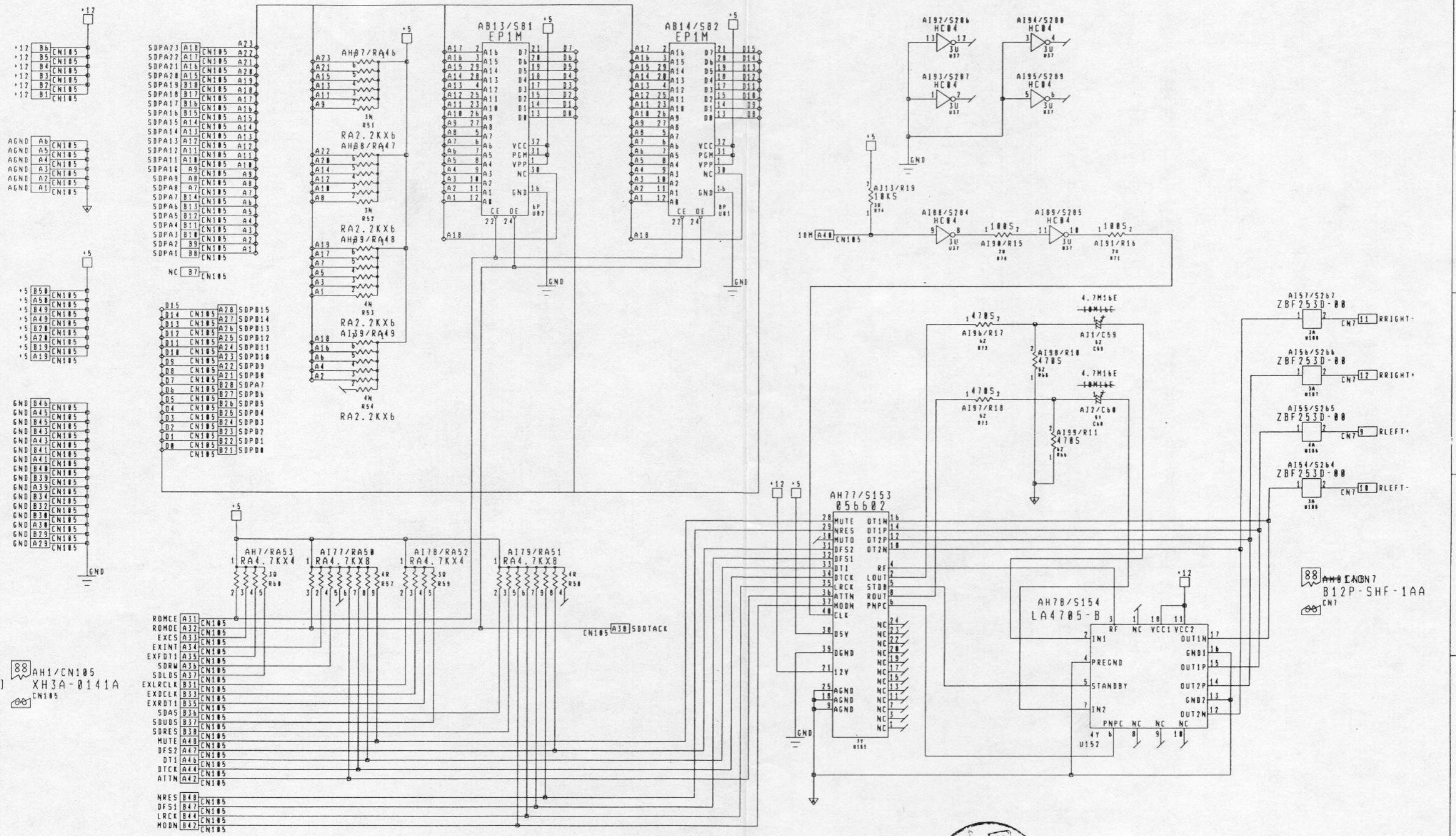

88 AH1/CN105  
 XH3A-0141A  
 CN105

PROPRIETARY AND CONFIDENTIAL:  
 REPRODUCTION FORBIDDEN WITHOUT THE SPECIFIC WRITTEN PERMISSION OF KONAMI CO., LTD., 4-3-1,  
 TORANOMON, MINATOKU, TOKYO 105, JAPAN. THIS DRAWING IS ONLY CONDITIONALLY ISSUED. NEITHER  
 RECEIPT NOR POSSESSION OF THIS DRAWING OR ANY OPERATING MANUAL RELATING TO KONAMI'S GAMES OR PRODUCTS  
 CONTAINING THIS DRAWING CONFERS OR TRANSFERS ANY RIGHT IN OR LICENSE TO USE THE PRINTED CIRCUIT BOARDS  
 RELATING TO THIS DRAWING OR OTHER SUBJECT MATTER OF THE DRAWING OR ANY DESIGN OR TECHNICAL INFORMATION  
 SHOWN THEREON, EXCEPT FOR MANUFACTURE BY VENDORS OF KONAMI CO., LTD. AND FOR MANUFACTURE UNDER  
 KONAMI'S WRITTEN LICENSE. NO RIGHT IS GRANTED TO REPRODUCE, MAKE, HAVE MADE, USE OR SELL THIS DRAWING  
 OR THE SUBJECT MATTER THEREOF INCLUDING, WITHOUT LIMITATION, THE PRINTED CIRCUIT BOARD OR OPERATING  
 MANUAL RELATING THERETO, WHATSOEVER, UNLESS BY WRITTEN AGREEMENT WITH OR WRITTEN PERMISSION FROM KONAMI  
 COPYRIGHT 1992 KONAMI CO., LTD. ALL RIGHTS RESERVED.

**KONAMI**

KONAMI CO., LTD.



DESIGN	M. NAGATOMI	TITLE	SCHEMATIC DIAGRAM
DRAW	Y. MATSUI	SUBTITLE	CN4 (SOUND)
CHECK	<i>Y. Matsui</i>	PAGE	4/13
APPROVE	<i>M. Nagatomi</i>	CODE NO.	354472A
SCALE		REG. TYPE	Gx250 PWB3542078
TOLERANCE		SECURITY LEVEL	RES. CONFIDENTIAL
DATE	94. 1. 18		

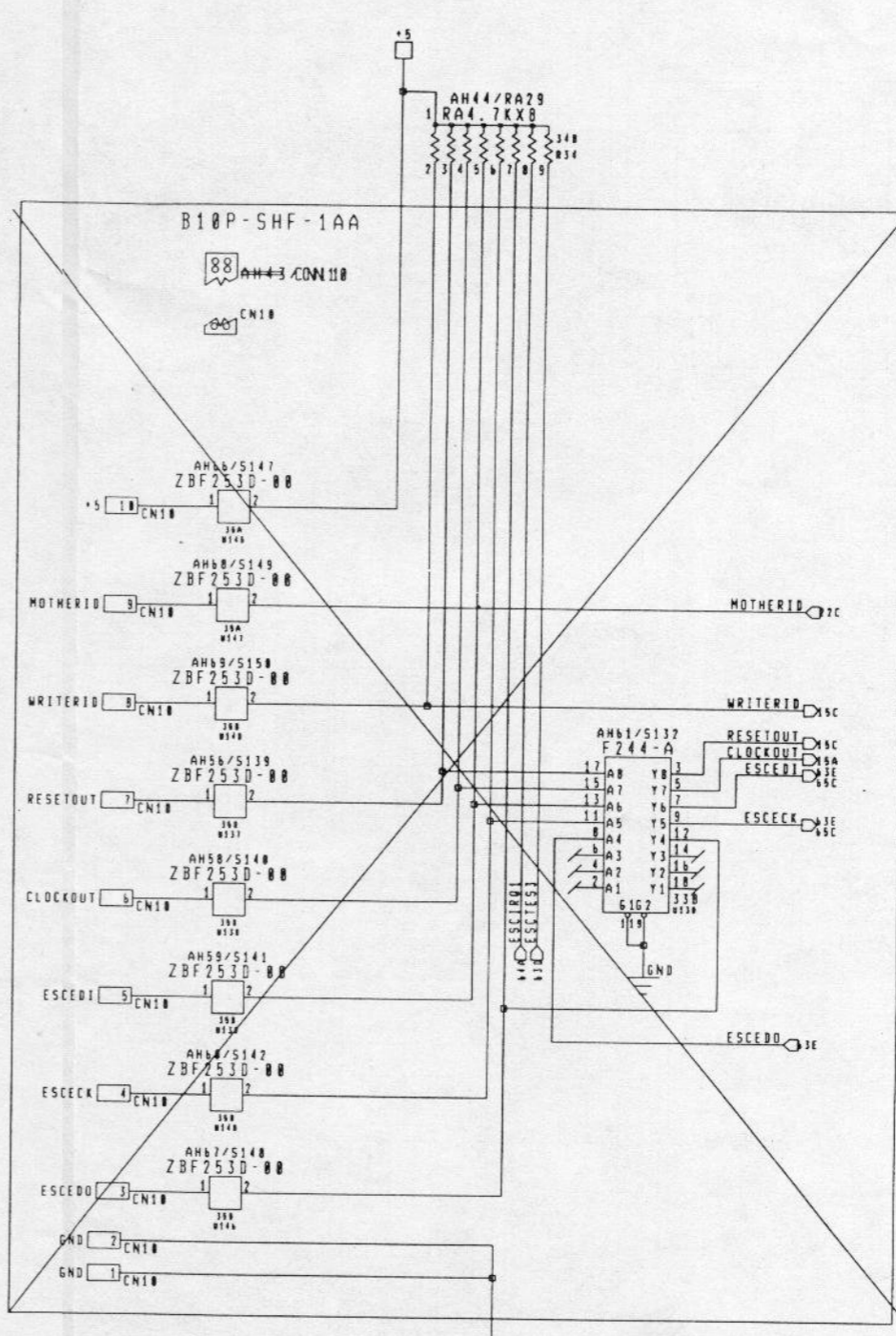
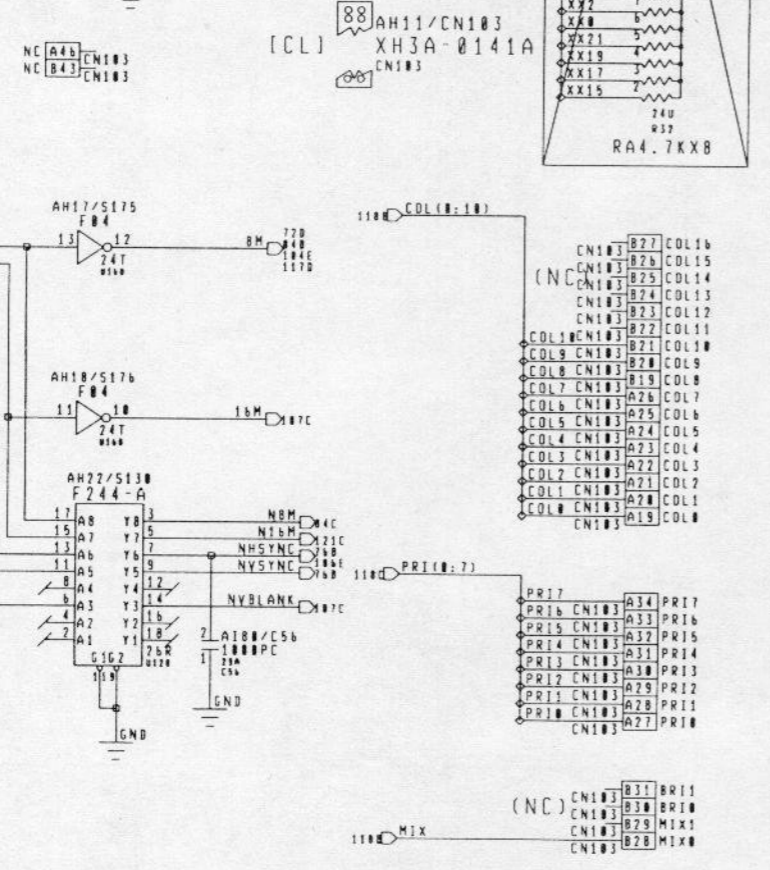
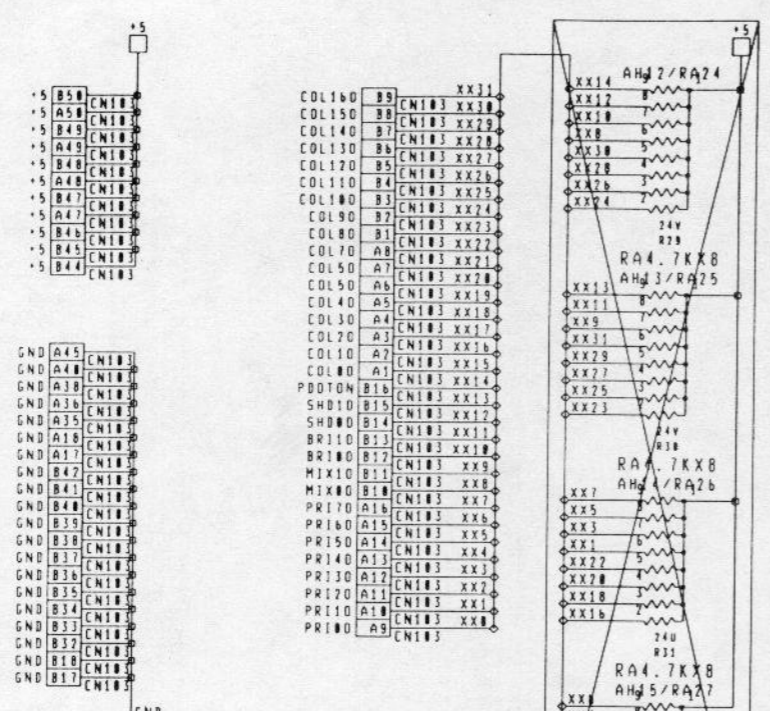

PROPRIETARY AND CONFIDENTIAL:  
 REPRODUCTION FORBIDDEN WITHOUT THE SPECIFIC WRITTEN PERMISSION OF KONAMI CO., LTD., 4-3-1, TORANOMON, MINATOKU, TOKYO 105, JAPAN. THIS DRAWING IS ONLY CONDITIONALLY ISSUED. NEITHER RECEIPT NOR POSSESSION OF THIS DRAWING OR ANY OPERATING MANUAL RELATING TO KONAMI'S GAMES OR PRODUCTS CONTAINING THIS DRAWING CONFERS OR TRANSFERS ANY RIGHT IN OR LICENSE TO USE THE PRINTED CIRCUIT BOARDS RELATING TO THIS DRAWING OR OTHER SUBJECT MATTER OF THE DRAWING OR ANY DESIGN OR TECHNICAL INFORMATION KONAMI'S WRITTEN LICENSE. NO RIGHT IS GRANTED TO REPRODUCE, MAKE, HAVE MADE, USE OR SELL THIS DRAWING OR THE SUBJECT MATTER THEREOF INCLUDING, WITHOUT LIMITATION, THE PRINTED CIRCUIT BOARD OR OPERATING MANUAL RELATING THERE TO, WHATSOEVER, UNLESS BY WRITTEN AGREEMENT WITH OR WRITTEN PERMISSION FROM KONAMI. COPYRIGHT 1992 KONAMI CO., LTD. ALL RIGHTS RESERVED.

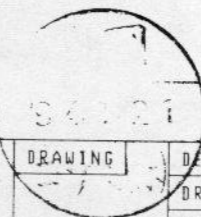

DRAWING	DESIGN	M. NAGATOMI	TITLE	SCHEMATIC DIAGRAM
	DRAW	Y. MATSUI	SUBTITLE	CN5 (EX)
	CHECK	<i>[Signature]</i>	PAGE	5/13
	APPROVE	<i>[Signature]</i>	CODE NO.	354472A
	SCALE		REG. TYPE	GX250 PWB354207B
	TOLERANCE		SECURITY LEVEL	CONFIDENTIAL
	DATE	94. 1. 18		





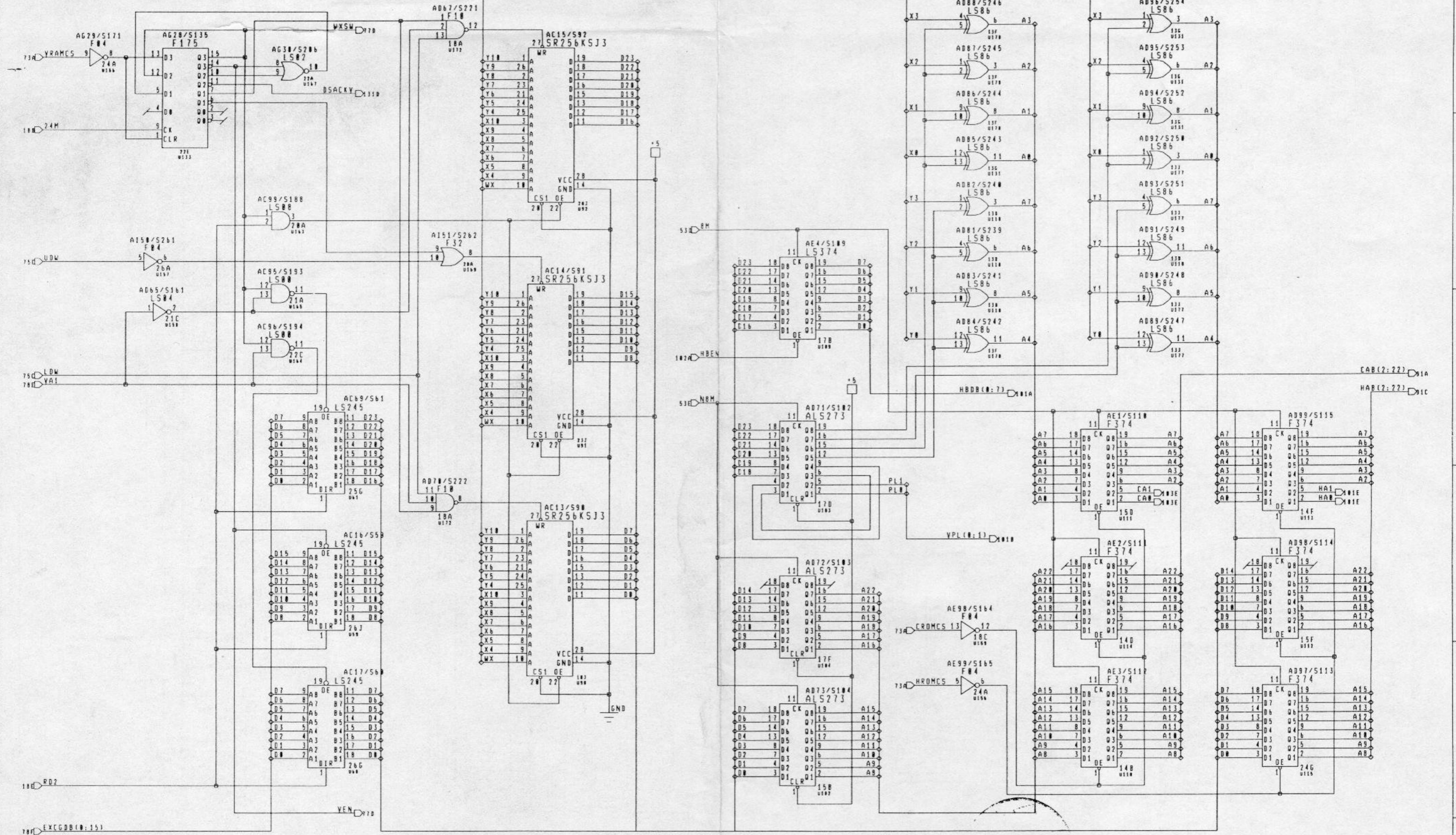

PROPRIETARY AND CONFIDENTIAL:  
 REPRODUCTION FORBIDDEN WITHOUT THE SPECIFIC WRITTEN PERMISSION OF KONAMI CO., LTD., 4-3-1, TORANOMON, MINATOKU, TOKYO 105, JAPAN. THIS DRAWING IS ONLY CONDITIONALLY ISSUED. NEITHER RECEIPT NOR POSSESSION OF THIS DRAWING OR ANY OPERATING MANUAL RELATING TO KONAMI'S GAMES OR PRODUCTS CONTAINING THIS DRAWING CONFERS OR TRANSFERS ANY RIGHT IN OR LICENSE TO USE THE PRINTED CIRCUIT BOARDS RELATING TO THIS DRAWING OR OTHER SUBJECT MATTER OF THE DRAWING OR ANY DESIGN OR TECHNICAL INFORMATION SHOWN THEREON, EXCEPT FOR MANUFACTURE BY VENDORS OF KONAMI CO., LTD. AND FOR MANUFACTURE UNDER KONAMI'S WRITTEN LICENSE. NO RIGHT IS GRANTED TO REPRODUCE, MAKE, HAVE MADE, USE OR SELL THIS DRAWING OR THE SUBJECT MATTER THEREOF INCLUDING, WITHOUT LIMITATION, THE PRINTED CIRCUIT BOARD OR OPERATING MANUAL RELATING THERETO, WHATSOEVER, UNLESS BY WRITTEN AGREEMENT WITH OR WRITTEN PERMISSION FROM KONAMI. COPYRIGHT 1992 KONAMI CO., LTD. ALL RIGHTS RESERVED.



KONAMI CO., LTD.

DRAWING	DESIGN	M. NAGATOMI	TITLE	SCHEMATIC DIAGRAM
	DRAW	Y. MATSUI	SUBTITLE	VRAM
	CHECK	<i>[Signature]</i>	PAGE	8/13
	APPROVE	<i>[Signature]</i>	CODE NO.	354472A
	SCALE		REG. TYPE	GX250 PWB354207B
	TOLERANCE		SECURITY LEVEL	CONFIDENTIAL
	DATE	94. 1. 18		



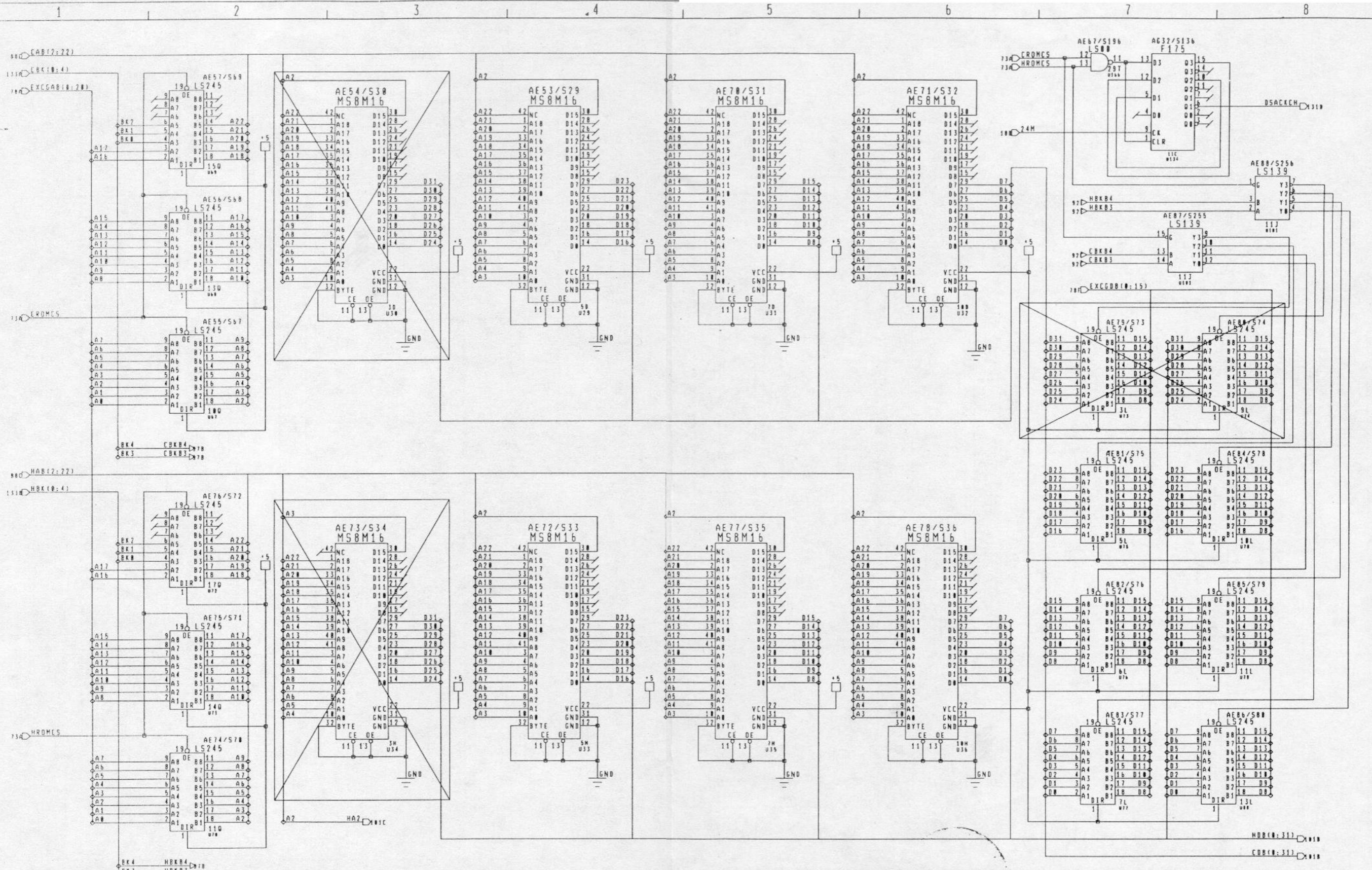

PROPRIETARY AND CONFIDENTIAL:  
 REPRODUCTION FORBIDDEN WITHOUT THE SPECIFIC WRITTEN PERMISSION OF KONAMI CO., LTD., 4-3-1, TORANOMON, MINATOKU, TOKYO 105, JAPAN. THIS DRAWING IS ONLY CONDITIONALLY ISSUED. NEITHER RECEIPT NOR POSSESSION OF THIS DRAWING OR ANY OPERATING MANUAL RELATING TO KONAMI'S GAMES OR PRODUCTS CONTAINING THIS DRAWING CONFERS OR TRANSFERS ANY RIGHT IN OR LICENSE TO USE THE PRINTED CIRCUIT BOARDS RELATING TO THIS DRAWING OR OTHER SUBJECT MATTER OF THE DRAWING OR ANY DESIGN OR TECHNICAL INFORMATION SHOWN THEREON, EXCEPT FOR MANUFACTURE BY VENDORS OF KONAMI CO., LTD. AND FOR MANUFACTURE UNDER KONAMI'S WRITTEN LICENSE. NO RIGHT IS GRANTED TO REPRODUCE, MAKE, HAVE MADE, USE OR SELL THIS DRAWING OR THE SUBJECT MATTER THEREOF INCLUDING, WITHOUT LIMITATION, THE PRINTED CIRCUIT BOARD OR OPERATING MANUAL RELATING THERETO, WHATSOEVER, UNLESS BY WRITTEN AGREEMENT WITH OR WRITTEN PERMISSION FROM KONAMI. COPYRIGHT 1992 KONAMI CO., LTD. ALL RIGHTS RESERVED.



DRAWING

DESIGN	M. NAGATOMI	TITLE	SCHEMATIC DIAGRAM
DRAW	Y. MATSUI	SUBTITLE	CROM, HROM
CHECK	<i>[Signature]</i>	PAGE	9/13
APPROVE	<i>[Signature]</i>	CODE NO.	354472A
SCALE		REG. TYPE	GX250 PWB354287B
TOLERANCE		SECURITY LEVEL	CONFIDENTIAL
DATE	94. 1. 18		

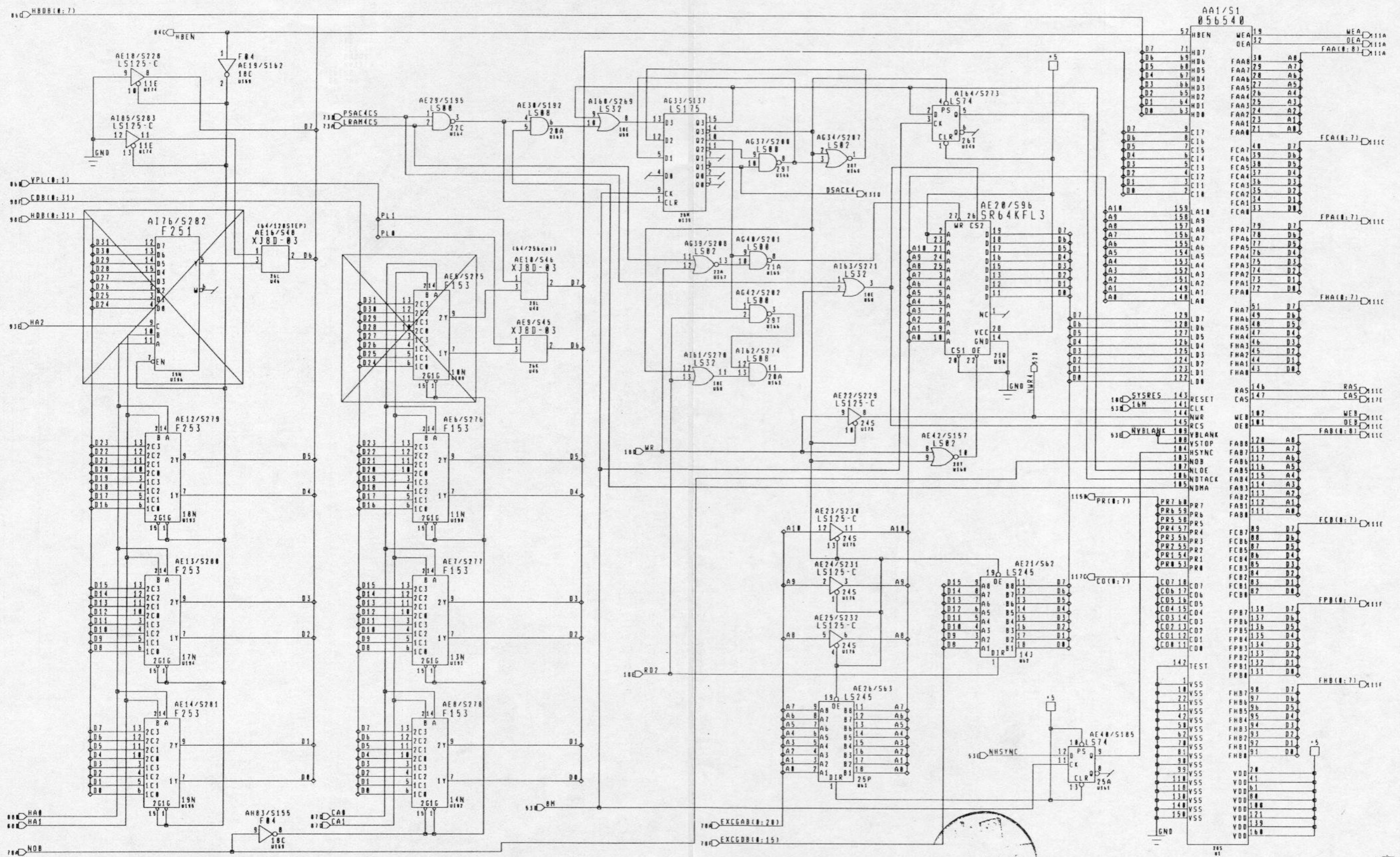

PROPRIETARY AND CONFIDENTIAL:  
 REPRODUCTION FORBIDDEN WITHOUT THE SPECIFIC WRITTEN PERMISSION OF KONAMI CO., LTD., 4-3-1, TORANOMON, MINATOKU, TOKYO 105, JAPAN. THIS DRAWING IS ONLY CONDITIONALLY ISSUED. NEITHER RECEIPT NOR POSSESSION OF THIS DRAWING OR ANY OPERATING MANUAL RELATING TO KONAMI'S GAMES OR PRODUCTS CONTAINING THIS DRAWING CONFERS OR TRANSFERS ANY RIGHT IN OR LICENSE TO USE THE PRINTED CIRCUIT BOARDS RELATING TO THIS DRAWING OR OTHER SUBJECT MATTER OF THE DRAWING OR ANY DESIGN OR TECHNICAL INFORMATION SHOWN THEREON, EXCEPT FOR MANUFACTURE BY VENDORS OF KONAMI CO., LTD. AND FOR MANUFACTURE UNDER KONAMI'S WRITTEN LICENSE. NO RIGHT IS GRANTED TO REPRODUCE, MAKE, HAVE MADE, USE OR SELL THIS DRAWING OR THE SUBJECT MATTER THEREOF INCLUDING, WITHOUT LIMITATION, THE PRINTED CIRCUIT BOARD OR OPERATING MANUAL RELATING THERETO, WHATSOEVER, UNLESS BY WRITTEN AGREEMENT WITH OR WRITTEN PERMISSION FROM KONAMI. COPYRIGHT 1997 KONAMI CO., LTD. ALL RIGHTS RESERVED.



DESIGN	M. NAGATOMI	TITLE	SCHEMATIC DIAGRAM
DRAW	Y. MATSUI	SUBTITLE	PSAC4
CHECK	<i>[Signature]</i>	PAGE	10/13
APPROVE	<i>[Signature]</i>	CODE NO.	354472A
SCALE		REG. TYPE	6X250 PWB3542070
TOLERANCE		SECURITY LEVEL	RES. CONFIDENTIAL
DATE	94. 1. 18		

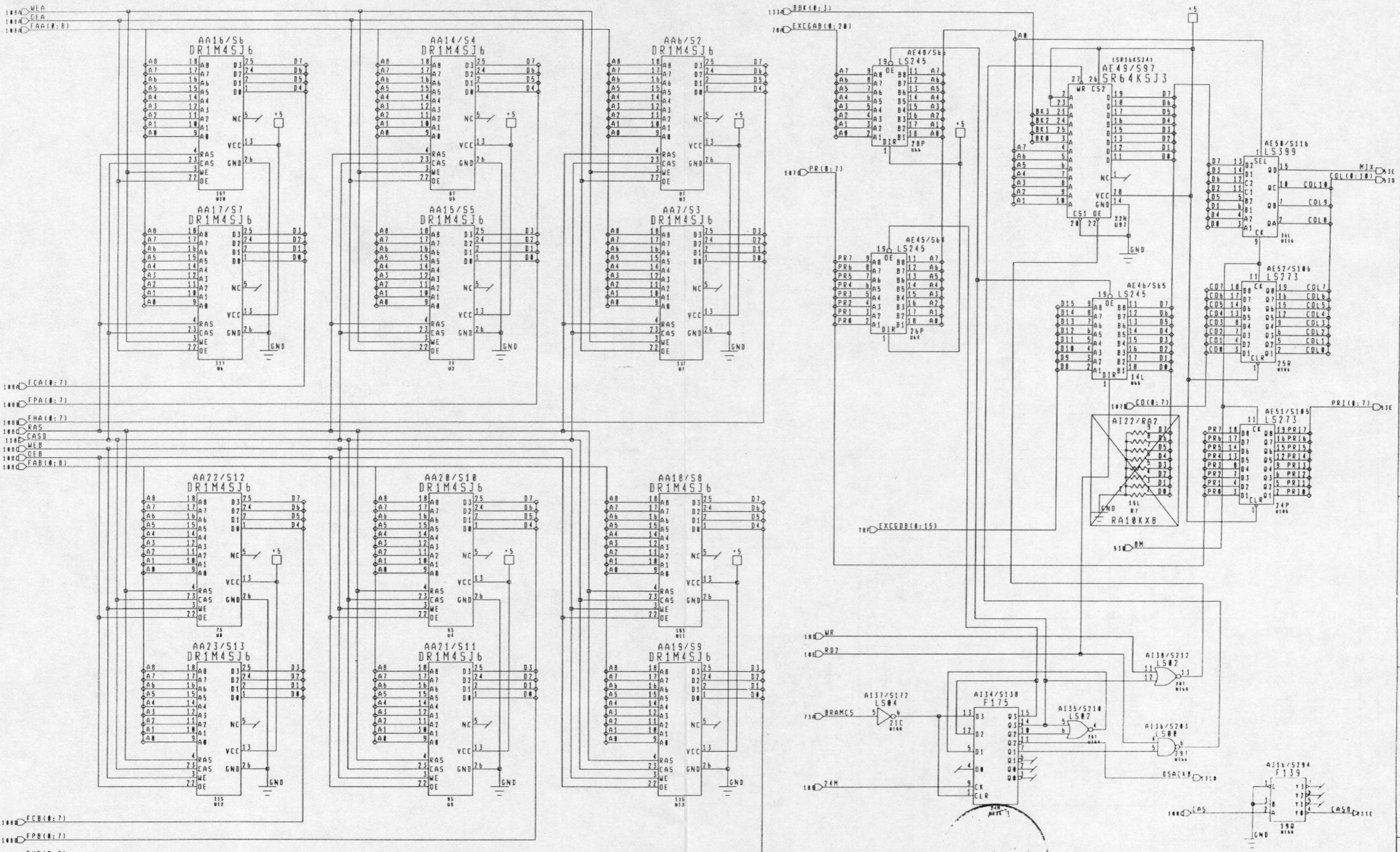

**PROPRIETARY AND CONFIDENTIAL:**  
 REPRODUCTION FORBIDDEN WITHOUT THE SPECIFIC WRITTEN PERMISSION OF KONAMI CO., LTD., 4-3-1, TORANOMON, MINATOKU, TOKYO 105, JAPAN. THIS DRAWING IS ONLY CONDITIONALLY ISSUED. NEITHER RECEIPT NOR POSSESSION OF THIS DRAWING OR ANY OPERATING MANUAL RELATING TO KONAMI'S GAMES OR PRODUCTS CONTAINING THIS DRAWING CONFERS OR TRANSFERS ANY RIGHT IN OR LICENSE TO USE THE PRINTED CIRCUIT BOARDS RELATING TO THIS DRAWING OR OTHER SUBJECT MATTER OF THE DRAWING OR ANY DESIGN OR TECHNICAL INFORMATION SHOWN THEREON. EXCEPT FOR MANUFACTURE BY VENDORS OF KONAMI CO., LTD. AND FOR MANUFACTURE UNDER KONAMI'S WRITTEN LICENSE, NO RIGHT IS GRANTED TO REPRODUCE, MAKE, HAVE MADE, USE OR SELL THIS DRAWING OR THE SUBJECT MATTER THEREOF INCLUDING, WITHOUT LIMITATION, THE PRINTED CIRCUIT BOARD OR OPERATING MANUAL RELATING THERETO, WHATSOEVER, UNLESS BY WRITTEN AGREEMENT WITH OR WRITTEN PERMISSION FROM KONAMI. COPYRIGHT 1992 KONAMI CO., LTD. ALL RIGHTS RESERVED.

**KONAMI**  
 KONAMI CO., LTD.

DRAWING	DESIGN	M. NAGATOMI	TITLE	SCHEMATIC DIAGRAM
	DRAW	Y. MATSUI	SUBTITLE	BRAM
	CHECK	<i>Y. Matsui</i>	PAGE	11/13
	APPROVE	<i>M. Naga.</i>	CODE NO.	354472A
	SCALE		REG. TYPE	EX250 PWB3542070
	TOLERANCE		SECURITY LEVEL	CONFIDENTIAL
	DATE	94. 1. 18		

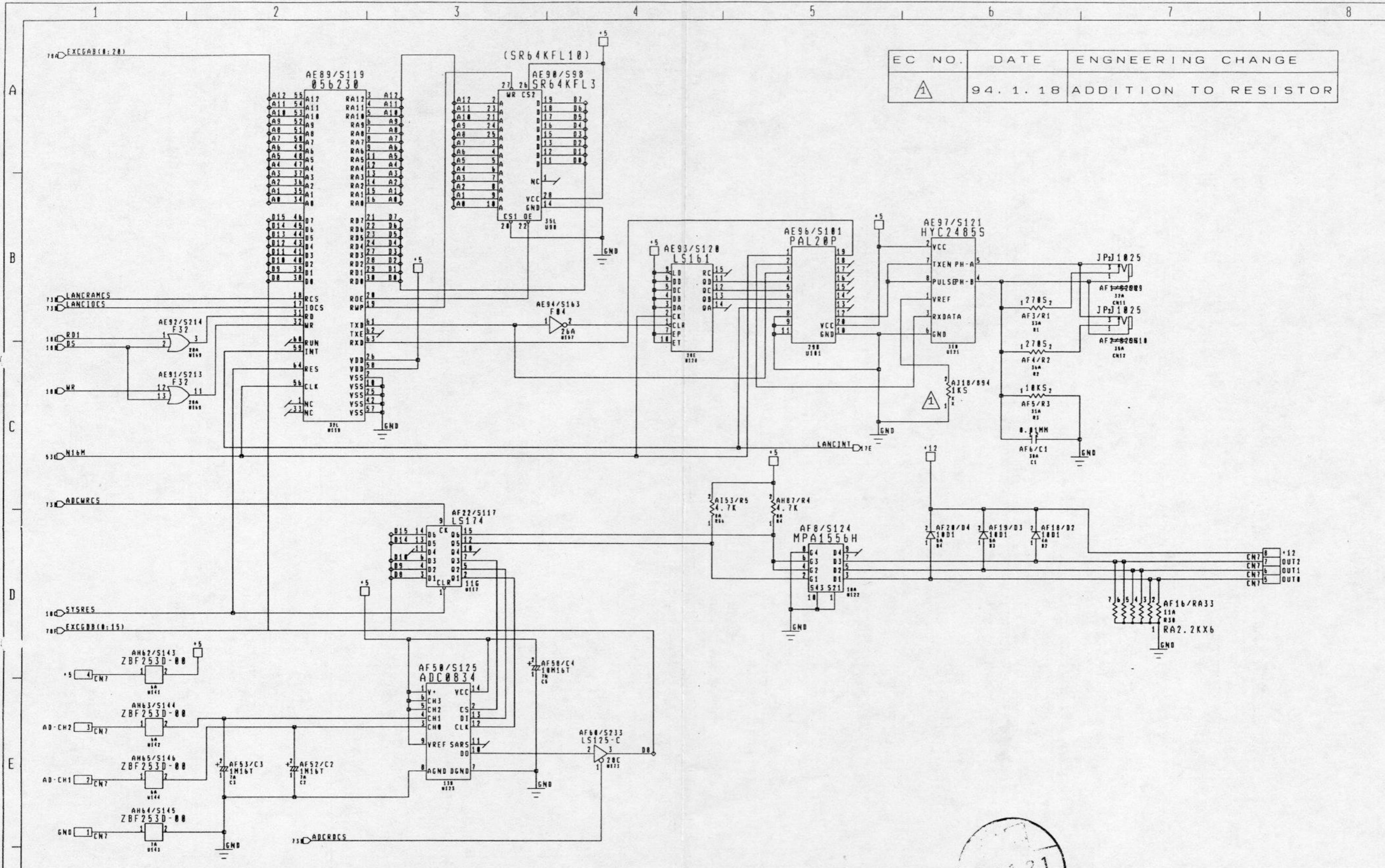

EC NO.	DATE	ENGINEERING CHANGE
△	94. 1. 18	ADDITION TO RESISTOR

**PROPRIETARY AND CONFIDENTIAL:**  
 REPRODUCTION FORBIDDEN WITHOUT THE SPECIFIC WRITTEN PERMISSION OF KONAMI CO., LTD., 4-3-1, TORANOMU, MINATO-KU, TOKYO 105, JAPAN. THIS DRAWING IS ONLY CONDITIONALLY ISSUED. NEITHER RECEIPT NOR POSSESSION OF THIS DRAWING OR ANY OPERATING MANUAL RELATING TO KONAMI'S GAMES OR PRODUCTS CONTAINING THIS DRAWING CONFERS OR TRANSFERS ANY RIGHT IN OR LICENSE TO USE THE PRINTED CIRCUIT BOARDS RELATING TO THIS DRAWING OR OTHER SUBJECT MATTER OF THE DRAWING OR ANY DESIGN OR TECHNICAL INFORMATION SHOWN THEREON. EXCEPT FOR MANUFACTURE BY VENDORS OF KONAMI CO., LTD. AND FOR MANUFACTURE UNDER KONAMI'S WRITTEN LICENSE, NO RIGHT IS GRANTED TO REPRODUCE, MAKE, HAVE MADE, USE OR SELL THIS DRAWING OR THE SUBJECT MATTER THEREOF INCLUDING, WITHOUT LIMITATION, THE PRINTED CIRCUIT BOARD OR OPERATING MANUAL RELATING THERETO, WHATSOEVER, UNLESS BY WRITTEN AGREEMENT WITH OR WRITTEN PERMISSION FROM KONAMI. COPYRIGHT 1992 KONAMI CO., LTD. ALL RIGHTS RESERVED.

**KONAMI**

KONAMI CO., LTD.

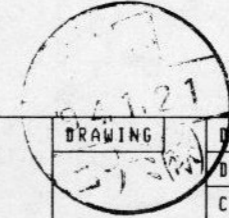

DRAWING	DESIGN	M. NAGATOMI	TITLE	SCHEMATIC DIAGRA
	DRAW	Y. MATSUI	SUBTITLE	EXIO
	CHECK	<i>Y. Matsui</i>	PAGE	12/13
	APPROVE	<i>R. Ueno</i>	CODE NO.	354472A-
	SCALE		REG. TYPE	Gx250 PM0354207B
	TOLERANCE		SECURITY LEVEL	RES. CONFIDENTIA
	DATE	94. 1. 18		

A  
B  
C  
D  
E  
F

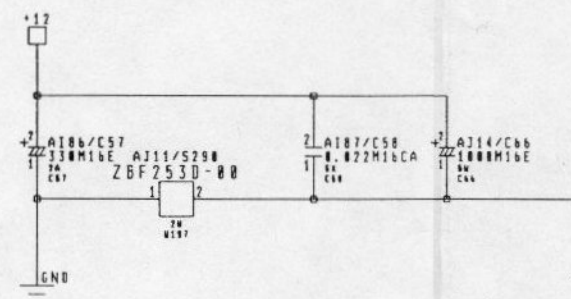
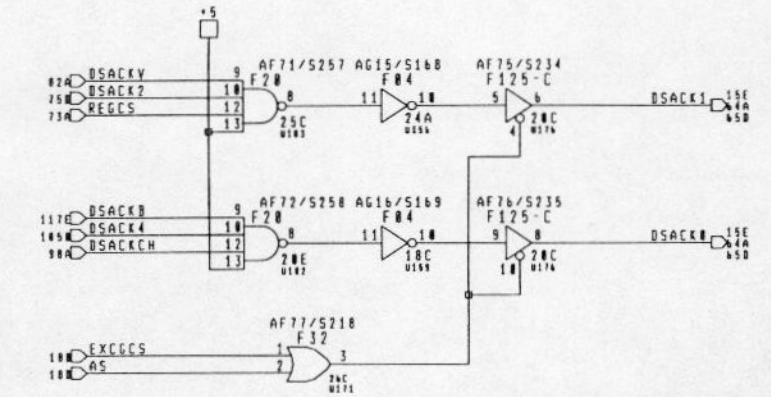
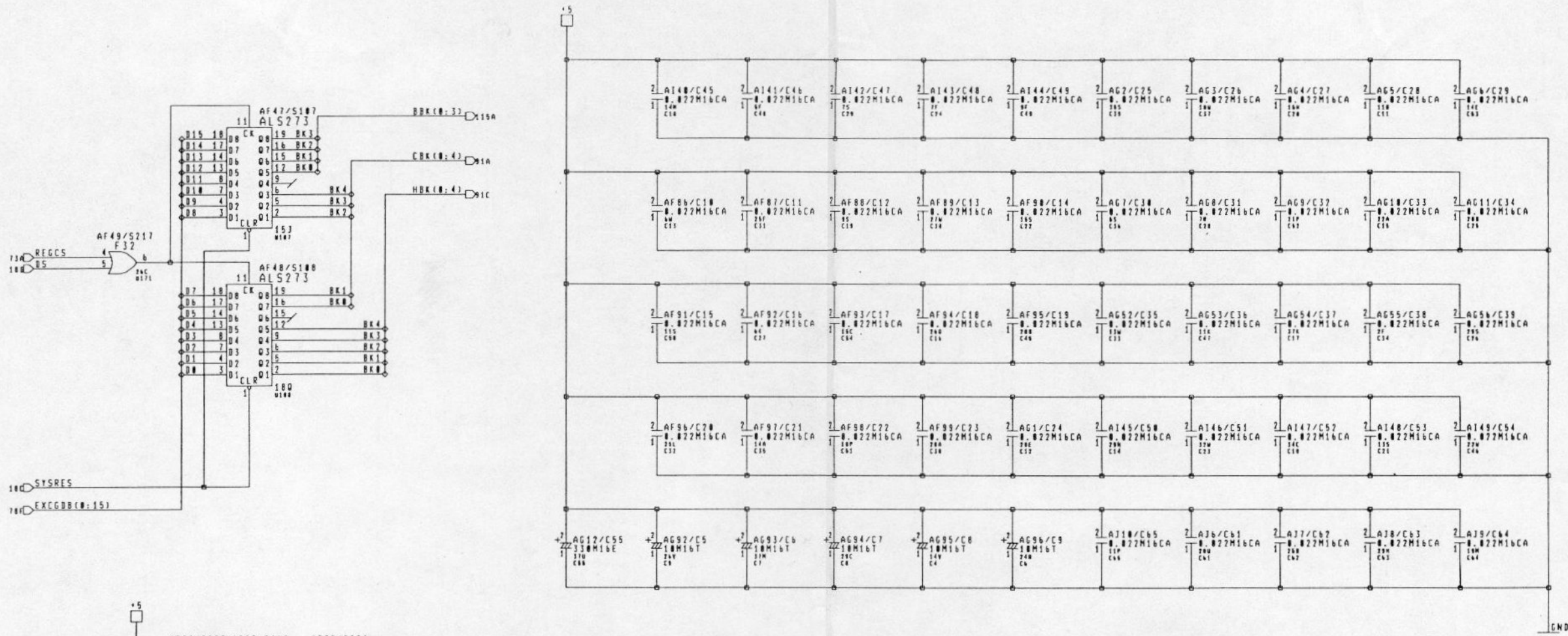

- NOTE -

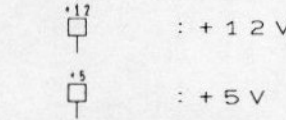

Not layout

- KIND OF CAPASITOR
- 1000M16E : 1600uF ELEC.
  - 330M16E : 330uF ELEC.
  - 4.7M50E : 4.7uF ELEC.
  - 10M16T : 10uFTANTALUM
  - 1M16T : 1uFTANTALUM
  - 0.01MM : 0.01uF MYLAR
  - 1000PC : 0.001uF CERAMI
  - 0.022M16CA: 0.022uF CERAMI
- (AXIAL LEAD TYPE)

SYSTEMGX  
SUB PCB TYPE 1

**PROPRIETARY AND CONFIDENTIAL:**  
REPRODUCTION FORBIDDEN WITHOUT THE SPECIFIC WRITTEN PERMISSION OF KONAMI CO., LTD., 4-3-1, TORANOMON, MINATOKU, TOKYO 105, JAPAN. THIS DRAWING IS ONLY CONDITIONALLY ISSUED. NEITHER RECEIPT NOR POSSESSION OF THIS DRAWING OR ANY OPERATING MANUAL RELATING TO KONAMI'S GAMES OR PRODUCTS CONTAINING THIS DRAWING CONFERS OR TRANSFERS ANY RIGHT IN OR LICENSE TO USE THE PRINTED CIRCUIT BOARDS RELATING TO THIS DRAWING OR OTHER SUBJECT MATTER OF THE DRAWING OR ANY DESIGN OR TECHNICAL INFORMATION SHOWN THEREON. EXCEPT FOR MANUFACTURE BY VENDORS OF KONAMI CO., LTD. AND FOR MANUFACTURE UNDER KONAMI'S WRITTEN LICENSE, NO RIGHT IS GRANTED TO REPRODUCE, MAKE, HAVE MADE, USE OR SELL THIS DRAWING OR THE SUBJECT MATTER THEREOF INCLUDING, WITHOUT LIMITATION, THE PRINTED CIRCUIT BOARD OR OPERATING MANUAL RELATING THERETO, WHATSOEVER, UNLESS BY WRITTEN AGREEMENT WITH OR WRITTEN PERMISSION FROM KONAMI. COPYRIGHT 1992 KONAMI CO., LTD. ALL RIGHTS RESERVED.

**KONAMI**

KONAMI CO., LTD.

DRAWING	DESIGN	M. NAGATOMI	TITLE	SCHEMATIC DIAGR
	DRAW	Y. MATSUI	SUBTITLE	REG
	CHECK	<i>Christina</i>	PAGE	13/13
	APPROVE	<i>H. Neno</i>	CODE NO.	354472A
	SCALE		REG. TYPE	GX250 PW354207B
	TOLERANCE		SECURITY LEVEL	CONFIDENTIAL
	DATE	94. 1. 18		