

This document has been downloaded from:



The largest resource for amusement machines
documentation on the world wide web!



FLIPPERSPILL.COM

August 1983
Game No's. 696-383



Bally MIDWAY

DISCS of TRON

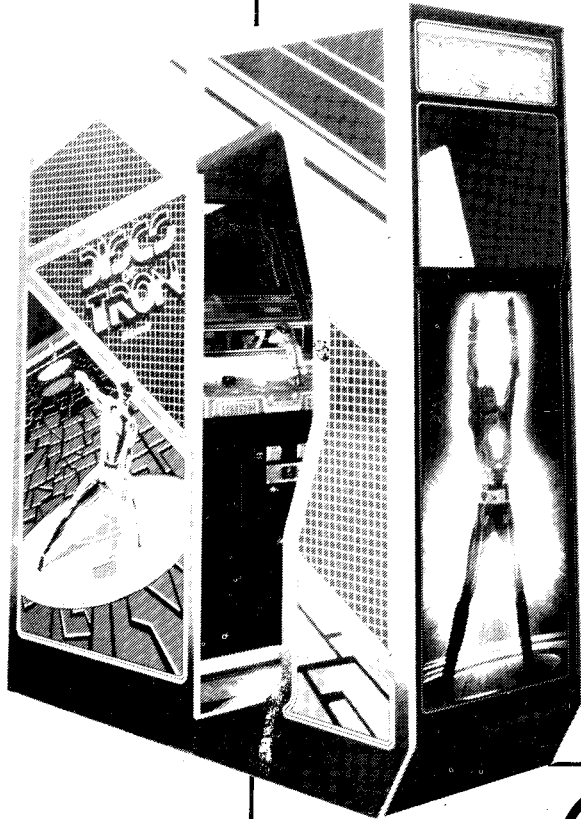

Parts and Operating Manual

Bally

MIDWAY MFG. CO.

10601 W. Belmont Avenue
Franklin Park, Illinois 60131
U.S.A.



Phone: (312) 451-9200 Cable Address: MIDCO Telex No.: 72-1596

WARNING

THIS GAME MUST BE GROUNDED. FAILURE TO DO SO MAY RESULT IN DESTRUCTION TO ELECTRONIC COMPONENTS.

WARNING: This equipment generates, uses, and can radiate radio frequency energy and if not used in accordance with the instructions manual, may cause interference to radio communications. It has been tested and found to comply with the limits for a CLASS A computing device pursuant to SUBPART J of PART 15 of FCC RULES, which are designed to provide reasonable protection against such interference when operated in a commercial environment. Operation of this equipment in a residential area is likely to cause interference in which case the user at his own expense will be required to take whatever measures may be required to correct the interference.

ELECTRICAL BULLETIN: FOR ALL APPARATUS COVERED BY THE CANADIAN STANDARDS ASSOCIATION (CSA) STANDARD C22.2 NO. 1, WHICH EMPLOYS A SUPPLY CORD TERMINATED WITH A POLARIZED 2-PRONG ATTACHMENT PLUG.

CAUTION: TO PREVENT ELECTRIC SHOCK DO NOT USE THIS (POLARIZED) PLUG WITH AN EXTENSION CORD, RECEPTACLE OR OTHER OUTLET UNLESS THE BLADES CAN BE FULLY INSERTED TO PREVENT BLADE EXPOSURE.

ATTENTION: POUR PREVENIR CHOCS ELECTRIQUES NE PAS UTILISER CETTE FICHE POLARISEE AVEC UN PROLONGATEUR. UNE PRISE DE COURANT OU UNE AUTRE SORTIE DE COURANT, SAUF SI LES LAMES PEUVENT ETRE INSEREES A FOND SANS EN LAISSER AUCUNE PARTIE A DECOUVERT.

Bally MIDWAYTM

Invites You To Use

**OUR TOLL FREE NUMBERS FOR
SERVICE INFORMATION CONCERNING THIS GAME, OR ANY
OTHER BALLY MIDWAY GAME YOU NOW HAVE ON LOCATION.**

**CALL US FOR PROMPT, COURTEOUS
ANSWERS TO YOUR PROBLEMS.**

VIDEO ➡ Continental U.S. 1-800-323-7182

PINBALL ➡ Continental U.S. 1-800-323-3555

Bally MIDWAYTM

10601 West Belmont Avenue, Franklin Park, Illinois, 60131

phone (312) 451-9200

© COPYRIGHT MCMLXXXIII BY BALLY/MIDWAY CO. ALL RIGHTS RESERVED.

NO PART OF THIS PUBLICATION MAY BE REPRODUCED BY ANY MECHANICAL, PHOTOGRAPHIC, OR ELECTRONIC PROCESS, OR IN THE FORM OF A PHONOGRAPHIC RECORDING, NOR MAY IT BE TRANSMITTED, OR OTHERWISE COPIED FOR PUBLIC OR PRIVATE USE, WITHOUT PERMISSION FROM THE PUBLISHER. THIS MANUAL IS FOR SERVICE USE ONLY, AND NOT FOR GENERAL DISTRIBUTION. FOR PERMISSION REQUESTS, WRITE: MIDWAY MFG. CO., 10750 W. GRAND AVE., FRANKLIN PARK, IL 60131

Printed in U.S.A.

TABLE OF CONTENTS

DESCRIPTION	PAGE
I. Game Operation	
Attract Mode	1-1
Ready-to-Play Mode	1-3
Play Mode	1-3
Two Player Operation	1-5
II. Illustrated Parts Breakdown	
No.696-Discs Of Tron Upright-Front	2-2
No.696-Discs Of Tron Upright-Front Parts List	2-3
No.696-Discs Of Tron Upright-Rear Access	2-5
No.696-Discs Of Tron Upright-Rear Access Parts List	2-6
No.383-Discs Of Tron Environmental-Front	2-8
No.383-Discs Of Tron Environmental-Front Parts List	2-9
No.383-Discs Of Tron Environmental-Rear Access	2-11
No.383-Discs Of Tron Environmental-Rear Access Parts List	2-12
No.383-Discs Of Tron Environmental-Control Area	2-14
No.383-Discs Of Tron Environmental-Control Area Parts List	2-15
Visual Effects Piece Parts Assembly	2-17
Discs Of Tron-Control Grip Assembly	2-18
Discs Of Tron-Control Grip Assembly-Parts List	2-19
Discs Of Tron-Optical Encoder Knob Assembly	2-20
Discs Of Tron-Optical Encoder Knob Assembly-Parts List	2-21
Power Chassis Assembly-125VA.,115V	2-22
Power Chassis Assembly-125VA.,115V.-Parts List	2-23
U.S.A. 25¢-Front Door Assembly	2-24
U.S.A. 25¢-Front Door Assembly-Parts List	2-25
III. Wiring Diagrams And Schematics	
Wiring Diagram-Upright	3-3
Wiring Diagram-Environmental	3-4
Sound I/O-P.C.B.-Component Layout	3-5
Sound I/O-P.C.B.-Schematic	3-6
Programmed C.P.U.-P.C.B.-Component Layout	3-7
Programmed C.P.U.-P.C.B.-Schematic	3-8
Video Generator-P.C.B.-Component Layout	3-9
Video Generator-P.C.B.-Schematic	3-10
Squalk & Talk-P.C.B.-Component Layout	3-11
Squalk & Talk-P.C.B.-Schematic	3-12
Lamp Sequential-P.C.B.-Component Layout-Environmental	3-13
Lamp Sequential-P.C.B.-Schematic-Environmental	3-14
Fluorescent Control-P.C.B.-Component Layout-Environmental	3-15
Fluorescent Control-P.C.B.-Schematic-Environmental	3-16
Relay Control-P.C.B.-Component Layout-Environmental	3-17
Relay Control-P.C.B.-Schematic-Environmental	3-18
Dual Power Amp W/Mixer-Component Layout	3-19
Dual Power Amp W/Mixer-Schematic	3-20
Auxiliary Power Supply-Component Layout	3-21
Auxiliary Power Supply-Schematic	3-22
125VA.-Power Supply Board-Component Layout	3-23
125VA.-Power Supply Board-Schematic	3-24
125VA.-Power Chassis-Upright & Environmental-Schematic	3-25

DISCS OF TRON

GAME OPERATION

ATTRACT MODE

1. The Attract mode starts:

Just after power has been turned on to the game. (Self-Test switch is in the "OFF" position.)

After a Self-Test has been completed and there are no more credits left in the games memory.

After a play has been finished, the score was not high enough to put the game into the

High Score/Initial mode, and there are no more credits left in the games memory.

After the High Score/Initial mode when there are no more credits left in its memory.

In the Attract mode, the game will give the following displays *centered* on the monitor screen:

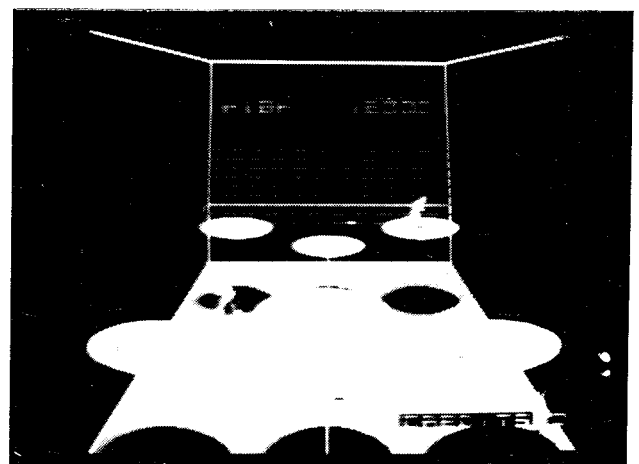
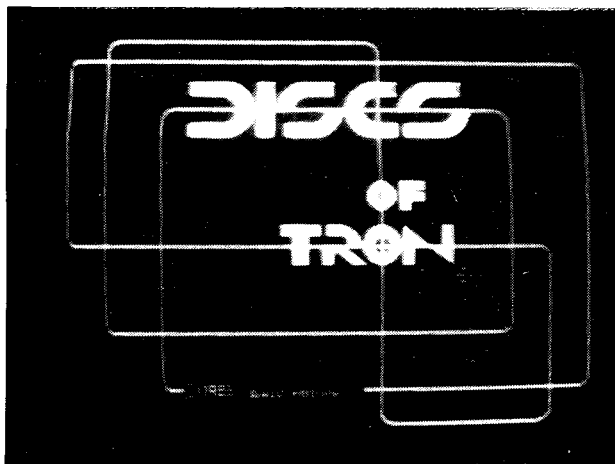

1 CREDIT PER PLAYER

INSERT COIN

DISCS OF TRON[®]

ALL RIGHTS RESERVED
BALLY MIDWAY SFG CO
COPYRIGHT 1982

CREDITS 2

TO DEFLECT DISCS:
HOLD IN DEFLECT BUTTON
HIT CHARGERS 2 TIMES
TO DESTROY THEM

HIT BUNK 2 TIMES TO ADVANCE
GRABING BUNK IS NOT A HIT







CREDITS 2

WHEN THE RING PLATFORMS
MOVE UP OR DOWN

CHANGE TARGET LEVEL BY
MOVING THE HANDS UP OR DOWN

CREDITS 2

POINT VALUES

	HIT BUNK	1000
	GRAB BUNK	200
	HIT A BUNK DISC	100
	ENERGY PELLETS	200
	CHARGERS	400
	SUPER CHARGERS	500

CREDITS 2

RANKINGS

1	ED	12000
2	EC	10200
3	AS	5500
4	FM	5400
5	BL	5400
6	AN	5000
7	DS	7200
8		5500
9	ES	5300
10	AN	3500

CREDITS 2

DIRECTIONS

YOU ARE TRON IN BLUE
BUNK IS OUT TO DEFEAT YOU!
THROW DISCS AND HIT HIM

POSITION HANDS TARGET
ON BALL WITH HANDS
AND THROW WITH TRIGGER

CREDITS 2

□ No matter where the game is in the Attract mode sequence, it will immediately go to the following display as soon as a game has been paid for. This display will remain on the monitor screen until the "1 PLAYER" or the "2 PLAYER" start button is pressed.

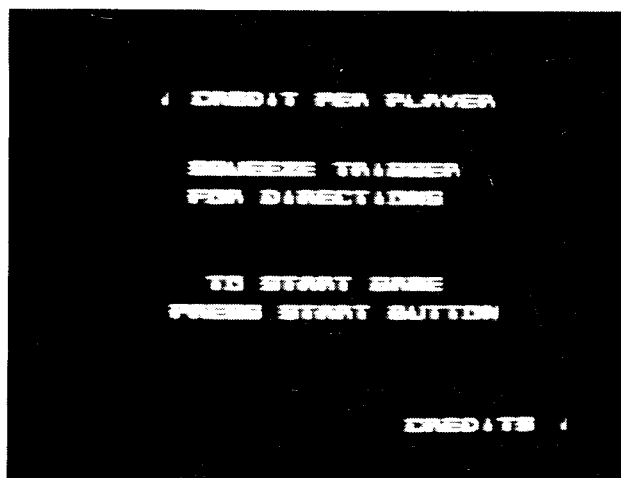

READY-TO-PLAY MODE

1. The **Ready-To-Play mode starts** when enough coins have been accepted for a 1 or a 2 player game.
2. The **Ready-To-Play mode ends** when either the "1 PLAYER" or the "2 PLAYER" push button is pressed.
3. In the Ready-To-Play mode, the game will give the above displays *centered* on the monitor screen.
4. If no START button is pressed, the displays will remain indefinitely on the monitor screen as shown above.

PLAY MODE

1. The **Play mode begins** when either the "1 PLAYER" or the "2 PLAYER" start button is pressed. (The game displays a message as to when **BONUS PLAYERS** are awarded.)
2. The **Play mode ends** when all of your PLAYERS have been eliminated. When this happens, "PLAYER 1" "GAME OVER" is written across the *center* of the monitor screen.

3. **ON THE SCREEN:** The game is made up a completely enclosed square ARENA, this includes the top and bottom. A varying number of RINGS (raised platforms) are inside this ARENA, depending what rack you are in. Each PLAYER has the same number of RINGS as his opponent. There is a line that runs around the inside center of this ARENA with a moveable target on it. As you advance into the higher racks of the game, obstacles appear between you and your opponent. Several other things also happen as you advance even farther into the more difficult racks of the game: the RINGS are at different heights, the target line can be moved up and down, and your PLAYER'S DISCS can be bounced off the ceiling and floor of the ARENA.

At the beginning of each rack, when a 2 PLAYER game has been selected, the game tells which player is up.

During each rack of play, the monitor constantly indicates on screen the number of PLAYERS that are playing any particular game, the number of reserve men each PLAYER has remaining to him, the number of shield deflections each PLAYER has left, which PLAYER is currently up, and a running total of the SCORE(s).

NOTE: The number of credits still remaining on the game is **ONLY** displayed in the Ready-To-Play mode.

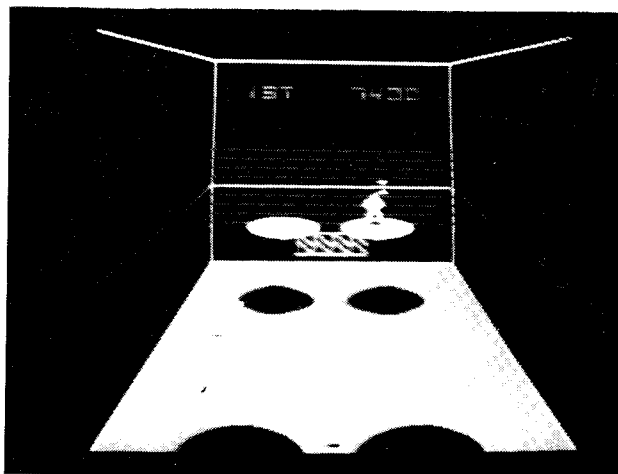

4. **PLAY BEGINS:** The ARENA appears on the monitor screen. Then the RINGS, moveable target, and the opponents appear on their RINGS. Now you must throw your DISCS at your opponent trying to knock him off his RING(s). If you can knock him off his RING(s) 3 successive times in a row, you will advance to the next rack (which is more difficult).
5. **DEFENSES:** Your opponent has quite a variety of things he can use to try to knock you off your RING(s). What these are is fully explained in the "INSTRUCTIONS" mode of the game. What, if any, DEFENSES you have against each one is also explained there.
6. **YOUR PLAYER:** He can move in **ANY DIRECTION** on the screen within the limits of his RING(s). Be careful though, if you try to make your PLAYER go too close to the edge of his RING(s), he can fall off - costing you one player. His movements are controlled by the joy stick on the games control panel.
7. **JOY STICK CONTROLLER:** This controls the direction your PLAYER will move in on his RING(s); either left, right, forward, or back. The TRIGGER on this CONTROLLER makes your player throw a DISC each time it is squeezed (**3 DISCS ARE ALL YOUR PLAYER HAS TO THROW** - after they are thrown, they **MUST** return to your player **BEFORE** they can **again** be thrown). There is also a SHIELD BUTTON on the top of this CONTROLLER which allows your PLAYER to deflect certain of your opponents weapons.
8. **TARGET CONTROLLER:** By using the TARGET CONTROLLER (knob at left side of Control Panel) you can position the moveable target at any location you desire on the walls of the ARENA.
9. **BONUS PLAYERS:** These can be awarded to the PLAYER as he reaches or passes certain preselected point values. This feature is adjustable by the games Owner/Operator.
10. **PLAY ENDS:** When your last PLAYER is eliminated, "PLAYER 1" "GAME OVER" is written across the *center* of the monitor screen.
11. **HIGH SCORE/INITIAL MODE:** If your score was high enough to become one of the ten best scores, the game will go into the High Score/Initial mode immediately after the above display. If your score is not high enough to cause the game to go into the High Score/Initial mode, it will either go to the Attract mode (if there are no more credits

left in its memory) or into the Ready-To-Play mode (if there are still credits left in its memory). In the High Score/Initial mode the game gives a display which looks like that shown.

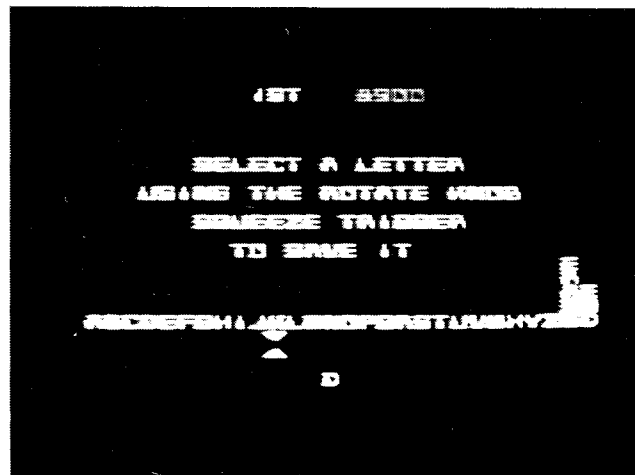

Follow the ON-SCREEN instructions to enter your initials next to your score in the league of the best ten players to date.

When you've printed out your last initial, move the cursor opposite the "END" word and activate the same control you did to enter your initials. This tells the game you are through printing out your initials. The game will then give the following RANKINGS display showing your score opposite your ranking and your initials.

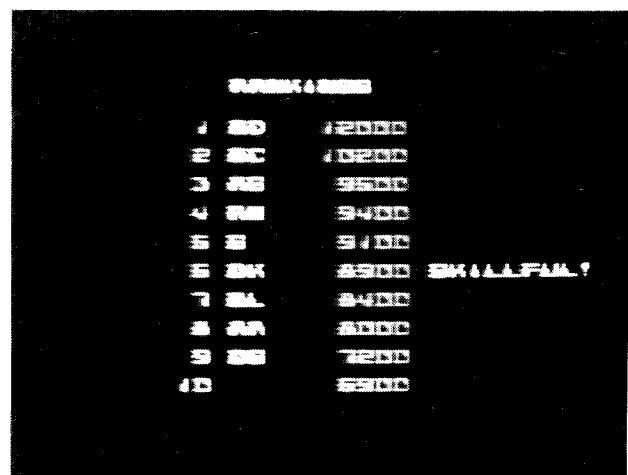

NOTE: If you don't tell the game you are through printing out your initials as instructed above, the game will automatically go into the RANKINGS display after a short wait.

After the High Score/Initial mode, the game will either go to the Attract mode (if there are no more credits left in its memory) or into the Ready-To-Play mode (if there are still credits left in its memory).

12. Most of the above holds true in the "2 PLAYER" mode also. But there are a few minor differences.

TWO PLAYER OPERATION

The Upright and Cocktail Table models all have two player operation (the **ENCLOSED** Upright model **only** has single player operation).

In the two player mode, the rules of play are the same as in the single player mode. There are some additional rules, however.

1. In the Upright models, the players must take turns at the controls.
2. In the Cocktail Table model, each player has his own set of individual controls. The picture will flip to face you when it is your turn. (When it is not your turn, your set of controls will have **NO** effect on the game.)
3. Your turn lasts until your **PLAYER** is eliminated. At this point, the game will do one of several things depending on whether or not the eliminated **PLAYER** was your last or if you still have others remaining in reserve.

PLAYER ELIMINATED - OTHERS REMAINING IN RESERVE

- The game stops and "**PLAYER**" is displayed on the screen.
- Next, the other players pattern and Opponents appear on the monitor screen and game play begins for the other player.

PLAYER ELIMINATED - NO OTHERS REMAINING IN RESERVE

- Game displays: "**PLAYER**" "**GAME OVER**" on the monitor screen.
- Next, if your score was high enough, the game will go into the HIGH SCORE/INITIAL mode. After this, it will indicate that the remaining **PLAYER** is up, that players pattern and Opponents appear on the monitor screen, and game play begins for him.

- If your score was not high enough to cause the game to go into the HIGH SCORE/INITIAL mode, it will indicate that the remaining **PLAYER** is up, that players pattern and Opponents appear on the monitor screen, and game play begins for him.

LAST PLAYER'S LAST PLAYER ELIMINATED - NO OTHERS REMAINING IN RESERVE

- Game displays: "**PLAYER**" "**GAME OVER**" on the monitor screen.
- Next, if your score was high enough, the game will go into the HIGH SCORE/INITIAL mode and then either to the Attract mode (if there are no more credits left in its memory) or into the Ready-To-Play mode (if there are still credits left in its memory).
- If your score was not high enough to cause the game to go into the HIGH SCORE/INITIAL mode, the game will either go to the Attract mode (if there are no more credits left in its memory) or into the Ready-To-Play mode (if there are still credits left in its memory).

RACK ADVANCE

Your **NEW** game is equipped with a **RACK ADVANCE** feature that can allow you to view and/or play the higher racks for test purposes. It is activated in the following manner:

1. Turn the power to the game "ON".
2. Open the coin door.

NOTE: COCKTAIL TABLE MODELS ONLY - gently pull out the plunger on the Safety Interlock Switch located just inside the coin door.

3. Using the Test Credit Button, put a credit on the game.
4. Press the "1 PLAYER" start button.
5. **IMMEDIATELY** set the games Self-Test switch to the "ON" position.
6. By pressing **EITHER ONE** or **BOTH** the "1 PLAYER" and/or "2 PLAYER" start button(s) you can make the game advance to the next rack (repeat for each rack you wish to advance).
7. When finished, set the Self-Test switch back to the "OFF" position, and close and lock the coin door.

II. Illustrated Parts Breakdown

NO. 696 - DISCS OF TRON UPRIGHT - FRONT

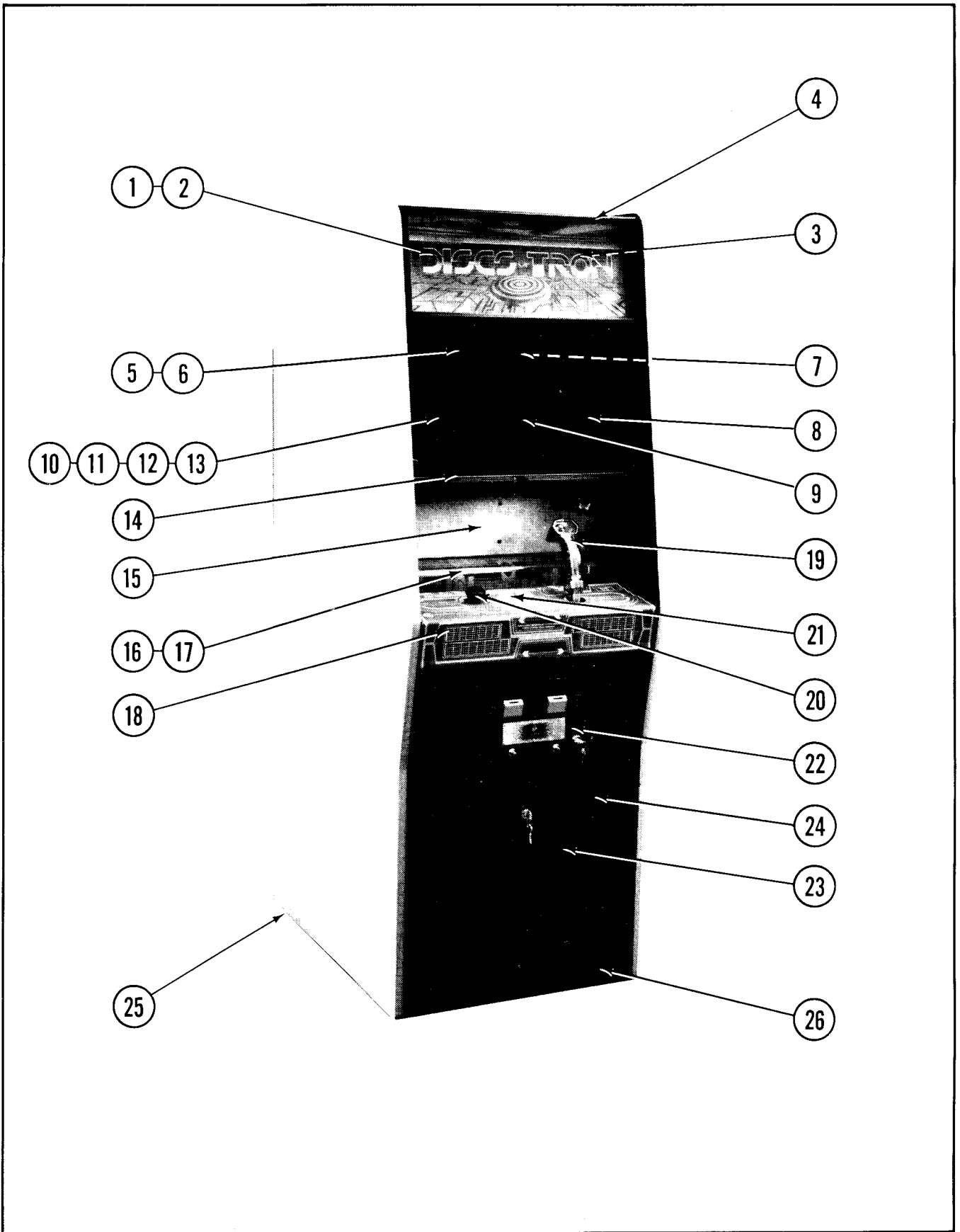

NO. 696 - DISCS OF TRON UPRIGHT - FRONT - PARTS LIST

ORDER BY PART NUMBER ONLY

ITEM	PART NUMBER	DESCRIPTION
1	0696-00901-00XF	HEADER GLASS - 23" x8-5/8" x3/16"
2	0383-00908-0000	3-D DECORATIVE HEADER - 22" x8-5/8"
3	A696-00041-0000	HEADER FLUORESCENT LIGHT ASSY.
	0696-00115-0000	FLUOR. BRKT.
	0017-00003-0043	18" COOL WHITE FLUOR. LAMP
	0017-00031-0036	FLUOR. SOCKET (2 REQ'D)
	0017-00003-0445	LAMP SOCKET LOCKS (2 REQ'D)
	0017-00003-0019	STARTER
	0017-00003-0412	STARTER SOCKET W/12" LEAD
	0017-00003-0026	BALLAST
	A961-00042-0000	LINE FILTER ASSY.
4	0574-00903-0100	HEADER RETAINING BRKT. (2 REQ'D)
	0017-00101-0138	#8x5/8 TORX TAMPER RESISTANT SCREW (8 REQ'D)
	0017-00009-0522	LONG ARM KEY T-20 (FOR ABOVE SCREW)
5	0017-00009-0393	BLACK SPEAKER GRILLE W/SLOTS (2 REQ'D)
6	0017-00003-0430	6" x9" SPEAKER - 4 OHM., LOW (2 REQ'D)
	0017-00101-0127	#8-32x1-1/2 CARRIAGE BOLT (8 REQ'D)
	0017-00103-0061	#8-32 HEX NUT W/SEMS (8 REQ'D)
7	0696-00048-0000	ARENA BLACK LIGHT W/O FILTER ASSY. (LOCATED BEHIND SPEAKERS
	0696-00118-0000	FLUOR. BRKT.
	0017-00003-0095	18" BLACK LIGHT LAMP
	0017-00003-0019	STARTER
	0017-00003-0412	STARTER SOCKET W/12" LEAD
	0017-00003-0026	BALLAST
	A961-00042-0000	LINE FILTER
8	0696-00915-0100	SIDE SCENERY - RIGHT
	0696-00915-0200	SIDE SCENERY - LEFT (OPPOSITE SIDE)
9	0696-00917-00XF	MAIN VIEWING GLASS - 23" x16-1/4" x3/16"
	0696-00121-00XF	GLASS HOLDING BRKT.
10	0383-00913-0000	MIRROPANE - 23-1/32" x19-11/16" x1/4"
	0696-00110-0000	MIRROR HOLD DOWN BRKT. (2 REQ'D)
11	0383-00901-00XF	SCENERY - RED (NOT SEEN) - 23-1/16" x17-1/2" x1/8"
	0696-00111-0000	RED SCENERY HOLD DOWN BRKT.
	0696-00109-0000	SCENERY HOLD DOWN BRKT.
12	0383-00902-00XF	SCENERY - BLUE (NOT SEEN) 23-1/16" x17" x1/8"
	0696-00110-0000	MIRROR HOLD DOWN BRKT. (2 REQ'D)
13	0383-00904-0000	SCENERY - REAR
	0383-00924-0000	SCENERY SUPPORT CHANNEL (2 REQ'D)
	0383-00115-00XF	SCENERY TRAP BRKT. (2 REQ'D)
14	0696-00909-0000	MONITOR BEZEL
15	0696-00120-00XF	GLASS RETAINER
	0017-00101-0138	#8x5/8 TORX PAN HD SCREW (6 REQ'D)
16	0696-00914-00XF	LAMP PROTECTOR
	0383-00102-0000	LAMP SHIELD BRKT.

NO. 696 - DISCS OF TRON UPRIGHT - FRONT - PARTS LIST

ORDER BY PART NUMBER ONLY

ITEM	PART NUMBER	DESCRIPTION
17	A696-00047-0000	CONTROL LIGHT ASSY.
	0696-00117-0000	FLUORESCENT BRKT.
	0017-00003-0095	18" BLACK LIGHT LAMP
	0383-00110-0000	REFLECTOR
	0017-00031-0036	FLUORESCENT SOCKET (2 REQ'D)
	0017-00003-0445	LAMP SOCKET LOCKS (2 REQ'D)
	0017-00003-0019	STARTER
	0017-00003-0412	STARTER SOCKET W/12" LEAD
	0017-00003-0026	BALLAST
	A961-00042-0000	LINE FILTER ASSY.
18	A696-00024-0000	CONTROL SHELF WELDMENT ASSY.
	0696-00906-0000	DECORATIVE OVERLAY
	A696-00036-0000	CONTROL CABLE W/TERMINAL STRIP ASSY.
	0696-00106-0100	CONTROL SHELF MTG BRKT. - RIGHT
	0696-00106-0200	CONTROL SHELF MTG BRKT. - LEFT
	0555-00901-0000	PLASTIC LOCATING PIN (4 REQ'D)
	0017-00009-0534	BASSICK CLAMP (3 REQ'D)
	0017-00101-0141	#8x11/16 UNSLOT HEX HD SCR (12 REQ'D)
	0316-00903-0000	CONTROL SHELF STRAP
	0383-00101-0000	CONTROL SHELF BACKUP BRKT.
19	A696-00007-0000	GRIP W/SWITCH ASSY.
	A696-00022-0000	CONTROL ASSY.
20	A696-00029-0000	KNOB & SHAFT ASSY.
	A696-00028-0000	OPTICAL ENCODER DISC ASSY.
21	0017-00042-0260	PUSH BUTTON ASSY.
	0017-00032-0093	PUSH BUTTON SWITCH W/HOLDER
	0017-00103-0054	5/8-11 PAL NUT
	0017-00104-0026	FLAT WASHER
	0017-00100-0025	1/4" E-RING
22	A982-00014-0004	U.S.A. COIN DOOR ASSY. W/CABLE ASSY.
	A982-00015-0000	COIN DOOR CABLE ASSY.
23	A090-00605-0000	CASH BOX DOOR & LOCK ASSY.
	A090-00606-0000	CASH BOX & PULL ASSY.
	0090-00189-0000	CASH BOX ENCLOSURE
24	A090-00603-00XF	COIN DOOR FRAME ASSY.
	0017-00101-0121	#6-32x5/16 PHIL TRS HD SCR (8 REQ'D)
25	0017-00102-0048	3/8-16x2" LEG LEVELERS (4 REQ'D)
25	0017-00102-0048	3/8-16x2" LEG LEVELERS (4 REQ'D)
	0017-00103-0026	3/8-16 LEVELER HEX NUTS (4 REQ'D)
26	0935-00906-0500	KICK PLATE - 23-1/8" LG

NO. 696 - DISCS OF TRON UPRIGHT - REAR ACCESS

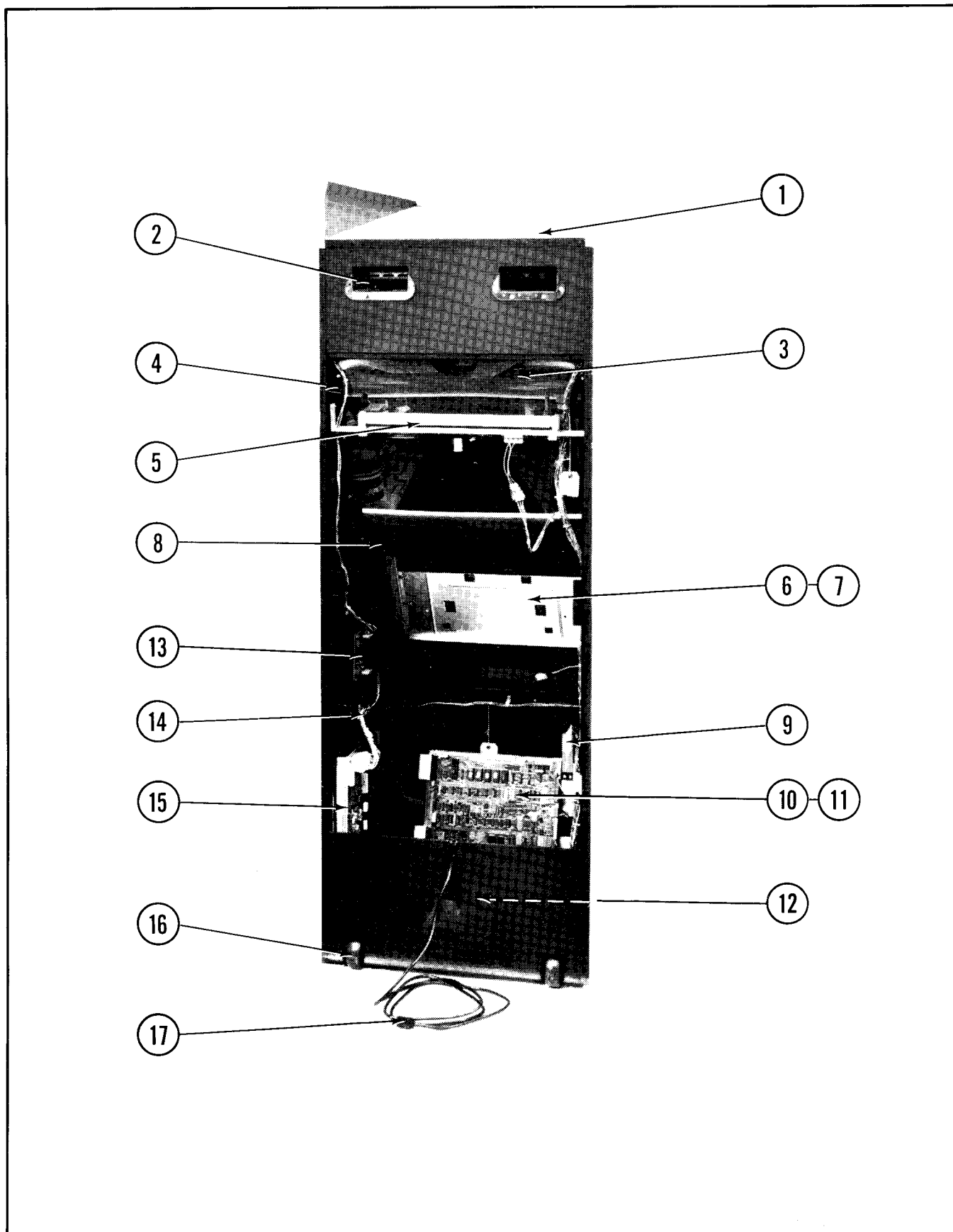

NO. 696 - DISCS OF TRON UPRIGHT - REAR ACCESS - PARTS LIST

ORDER BY PART NUMBER ONLY

ITEM	PART NUMBER	DESCRIPTION
1	A945-00038-0000	ON-OFF SWITCH PLATE ASSY.
2	0894-00916-0000	PLASTIC PULL & ENT (2 REQ'D)
	0017-00101-0141	#8x11/16 UNSLOT HEX HD M.S. (8 REQ'D)
3	0383-00904-0000	REAR SCENERY
4	0383-00115-00XF	SCENERY TRAP BRKT.
5	A696-00049-0000	REAR SCENERY FLUOR. LIGHT ASSY.
	0696-00119-0000	REAR FLUORESCENT BRKT.
	0017-00003-0043	18" COOL WHITE FLUOR. LAMP
	0017-00031-0036	FLUORESCENT SOCKET (2 REQ'D)
	0017-00003-0445	LAMP SOCKET LOCKS (2 REQ'D)
	0017-00003-0019	STARTER
	0017-00003-0412	STARTER SOCKET
	0017-00003-0026	BALLAST
	A961-00042-0000	LINE FILTER ASSY.
6	0017-00003-0339	ELECTROHOME 19" COLOR DUAL SYNC HORIZ. MTG. MONITOR (OR)
6	0017-00003-0439	WELLS-GARDNER 19" COLOR DUAL SYNC HORIZ. MTG. MONITOR (OR)
6	0017-00003-0454	ZENITH 19" COLOR DUAL SYNC HORIZ. MTG. MONITOR
	0636-00101-0000	MONITOR RAIL (2 REQ'D)
	0555-00901-0000	PLASTIC LOCATING PIN (4 REQ'D)
7	0696-00913-0000	MONITOR SHIELD
8	0696-00910-0000	REAR MASK
9	A088-00016-0000	INTERLOCK SWITCH & SPRING BRKT. ASSY.
	0303-00904-0000	INTERLOCK SWITCH COVER
10	A696-00008-0000	CARDRACK ASSY. W/BOARDS
	A084-90913-A696	SOUND I/O P.C. BRD. ASSY.
	A639-00060-0000	SHIELD & BARRIER ASSY.
	0017-00101-0134	#6-32x1/4 SLT. HEX HD. M.S. (4 REQ'D)
	A084-91490-A696	PROGR. CPU P.C. BRD. ASSY.
	A358-00016-0000	SHIELD & SPACER ASSY. - INNER
	A084-91464-A696	VIDEO GENERATOR P.C. BRD. ASSY.
	A358-00017-0000	SHIELD & SPACER ASSY. - OUTER
	0017-00101-0153	#6-32x1" SLT. HEX HD. M.S. (8 REQ'D)
11	A383-00020-0000	SUPPORT BRKT. ASSY. - TOP OF CARDRACK
12	A945-00020-0000	POWER CHASSIS ASSY. - 125VA., 115V
13	A084-91648-A000	DUAL POWER AMP W/MIXER ASSY.
14	A084-91631-B000	AUXILIARY POWER SUPPLY BOARD
15	A084-90412-D000	POWER SUPPLY P.C. BRD. ASSY. - 125VA
	0624-00902-0100	P.C. SUPPORT BRKT. - 12" LG (2 REQ'D)
	0624-00902-0300	P.C. SUPPORT BRKT. - 2-1/2" LG (2 REQ'D)
	0624-00902-0500	P.C. SUPPORT BRKT. - 6-1/2" LG (4 REQ'D)
	0017-00104-0037	#8 FLAT WASHER (14 REQ'D)
	0017-00101-0141	#8x11/16 UNSLOT HEX HD SCREW (14 REQ'D)
16	A961-00007-0000	CASTER ASSY. (2 REQ'D)
17	A945-00019-0000	LINE CORD ASSY. - 115V

NO. 696 - DISCS OF TRON UPRIGHT - REAR ACCESS - PARTS LIST

ORDER BY PART NUMBER ONLY

ITEM	PART NUMBER	DESCRIPTION
ADDITIONAL PARTS LIST		
	A097-00009-0000	BACK DOOR LOCK ASSY.
	0017-00009-0490	5-5/8" SQR VENT GRILLE (BACK DOOR)
	A696-00012-0000	MASTER CABLE W/BRKT. ASSY.
	A696-00014-0000	HIGH VOLTAGE CABLE ASSY.
	A941-00008-0000	LOW VOLTAGE CABLE ASSY.
	A337-00018-0000	VIDEO CABLE ASSY.
	A696-00034-0000	AUDIO ADAPTER CABLE ASSY.
	A696-00010-0000	CONTROL SHELF CABLE ASSY.

NO. 383 - DISCS OF TRON ENVIRONMENTAL - FRONT

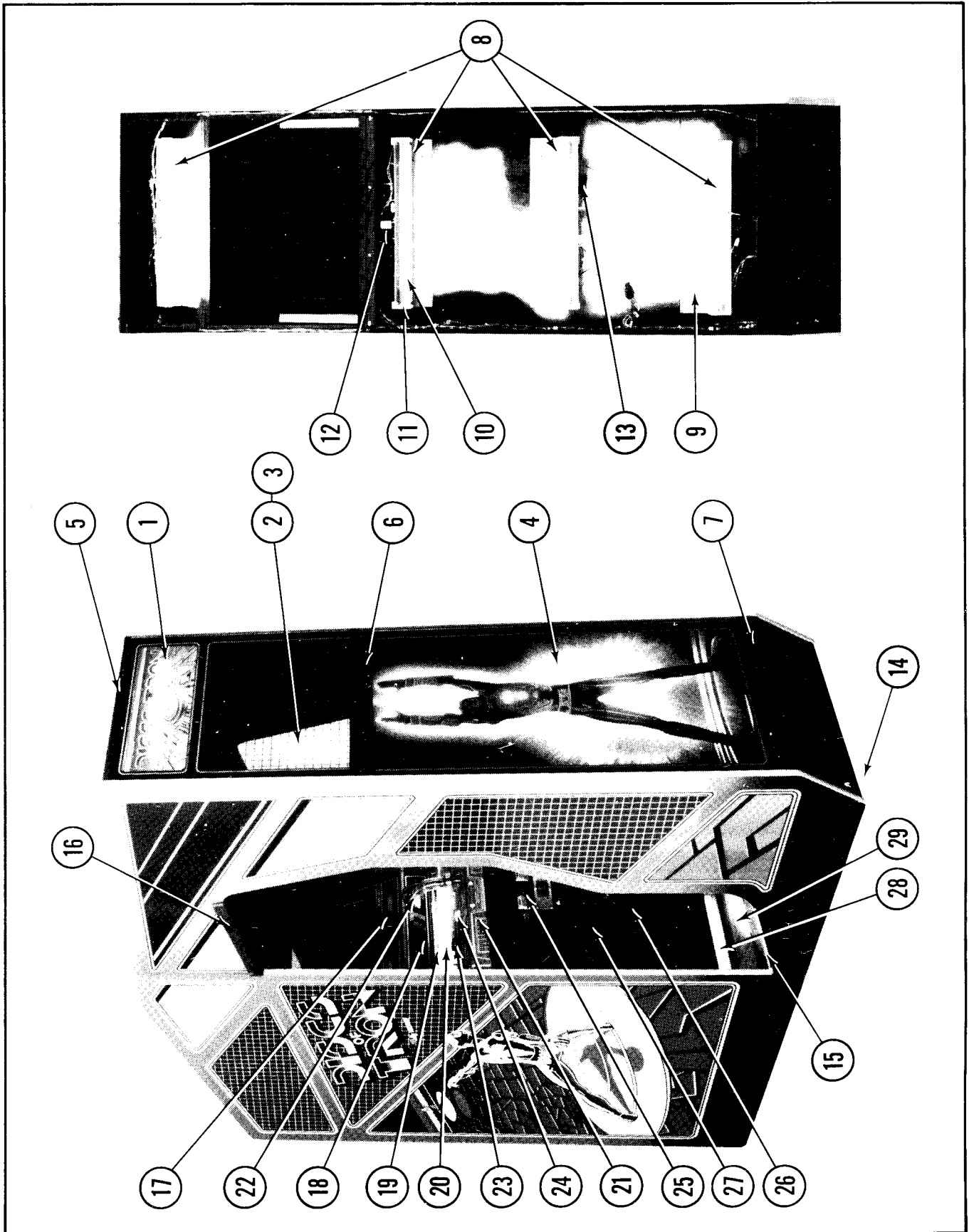

NO. 383 - DISCS OF TRON ENVIRONMENTAL - FRONT - PARTS LIST

ORDER BY PART NUMBER ONLY

ITEM	PART NO.	DESCRIPTION
1	0383-00908-0000	3-D DECORATIVE HEADER 22"x8-5/8"
2	0383-00907-00XF	FRONT GLASS -23"X25-17/32"x3/16"
3	R901-30000-0025	PLAIN TEMPERED GLASS - 23"x16-19/32"x1/8"
4	0383-00906-00XF	BILLBOARD GLASS - 23"x39-23/32"x3/16"
5	0383-00109-00XF	HEADER BRACKET
6	0383-00107-00XF	BILLBOARD BRACKET
7	0383-00112-00XF	GLASS RETAINER
	0017-00101-0138	#8x5/8 TORX TAMPER RESISTANT SCREW (11 REQ'D.)
	0017-00009-0522	LONG ARM KEY T-20 (FOR ABOVE SCREW)
8	A383-00018-0000	HEADER LIGHT W/O LINE FILTER (4 REQ'D.)
	A383-00022-0000	FLUOR. W/O FILTER CABLE ASSY.
9	0595-00105-0000	FLUORSCENT BRKT.
10	0017-00003-0043	18" COOL WHITE FLUOR. LAMP
11	0017-00031-0036	FLUORSCENT SOCKET (2 REQ'D.)
	0017-00003-0445	LAMP LOCK (2 REQ'D.)
12	0017-00003-0019	STARTER
	0017-00003-0412	STARTER HOLDER
13	0017-00003-0026	BALLAST
14	0017-00102-0048	3/8-16x2" LEG LEVELERS (6 REQ'D.)
	0017-00103-0026	3/8-16 LEVELER HEX NUTS (6 REQ'D.)
15	0383-00116-0000	T-MOLDING GUARD (2 REQ'D.)
	0017-00101-0192	#8-32x1/2 PHIL. PAN HD. SCREW (6 REQ'D.)
16	0383-00923-0000	BUMPER (2 REQ'D.)
	0017-00101-0088	#8x3/4 BLACK PHIL. FLAT HD. SCREW (12 REQ'D.)
17	0383-00915-00XF	MAIN VIEWING GLASS
18	0383-00112-00XF	GLASS RETAINER
19	0383-00912-00XF	LAMP PROTECTOR
20	A696-00038-0000	CONTROL FLUOR. BLACKLIGHT W/O LINE FILTER
21	A383-00010-0000	CONTROL SHELF WELDMENT ASSY.
	0383-00900-0000	DECORATIVE OVERLAY
	A383-00005-0000	CONTROL SHELF CABLE ASSY.
	0595-00106-0100	CONTROL SHELF MTG. BRKT. - RIGHT
	0595-00106-0200	CONTROL SHELF MTG. BRKT. - LEFT
	0555-00901-0000	PLASTIC LOCATING PIN (4 REQ'D.)
	0017-00009-0534	BASSICK CLAMP (3 REQ'D.)
	0017-00101-0141	#8x11/16 UNSLOT HEX HD. SCR. (12 REQ'D.)
	0383-00104-0000	CONTROL SHELF STRAP
	0383-00101-0000	CONTROL SHELF BACKUP BRKT.
22	A696-00007-0000	GRIP W/SWITCH ASSY.
	A696-00022-0000	CONTROL ASSY.
23	A696-00029-0000	KNOB & SHAFT ASSY.
	A696-00028-0000	OPTICAL ENCODER DISC ASSY.
24	0017-00042-0260	PUSHBUTTON ASSEMBLY
	0017-00032-0093	PUSHBUTTON SWITCH W/HOLDER
	0017-00103-0054	5/8-11 PAL NUT
	0017-00104-0026	FLAT WASHER
	0017-00100-0025	1/4" E-RING

NO. 383 -DISCS OF TRON ENVIRONMENTAL -FRONT -PARTS LIST

ORDER BY PART NUMBER ONLY

ITEM	PART NO.	DESCRIPTION
25	A982-00014-0004	U.S.A. 50¢ COIN DOOR ASSY. W/CABLE ASSY.
	A982-00015-0000	COIN DOOR CABLE ASSY.
26	A090-00605-0000	CASH BOX DOOR & LOCK ASSY.
	A090-00606-0000	CASH BOX & PULL ASSY.
	0090-00189-0000	CASH BOX ENCOSURE
27	A090-00603-00XF	COIN DOOR FRAME ASSY.
	0017-00101-0121	#6-32x5/16 PHIL TRS. HD. SCR. (7 REQ'D.) (MOUNTS COIN DOOR TO FRAME)
28	A383-00019-0000	FLASHING FLUOR. FOOT LIGHT W/O FILTER ASSY. (2 REQ'D.)
	A696-00043-0000	FLASHING LIGHT CABLE ASSY.
	0383-00117-0000	FLUORSCENT BRKT.
	0017-00003-0046	18" BLACK LIGHT
	0017-00031-0036	FLUOR. SOCKET (2 REQ'D.)
	0017-00003-0445	LAMP LOCK (2 REQ'D.)
	0017-00003-0026	BALLAST
	MT00-00125-A000	POWER TRANSFORMER - 60HZ.
29	0383-00911-0000	LIGHT COVER/FRONT
	0017-00101-0138	#8x5/8 TORX TMPER RESISTANT PAN HD. SCR. (3 REQ'D.)

NO. 383 - DISCS OF TRON ENVIRONMENTAL - REAR ACCESS

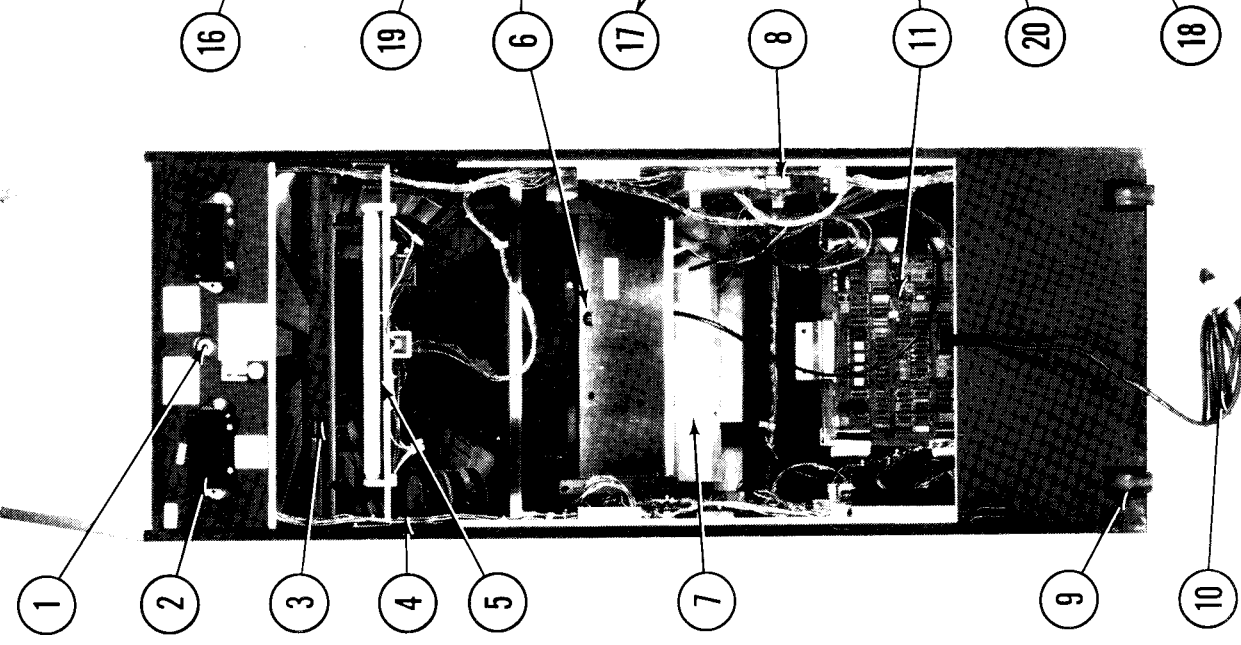
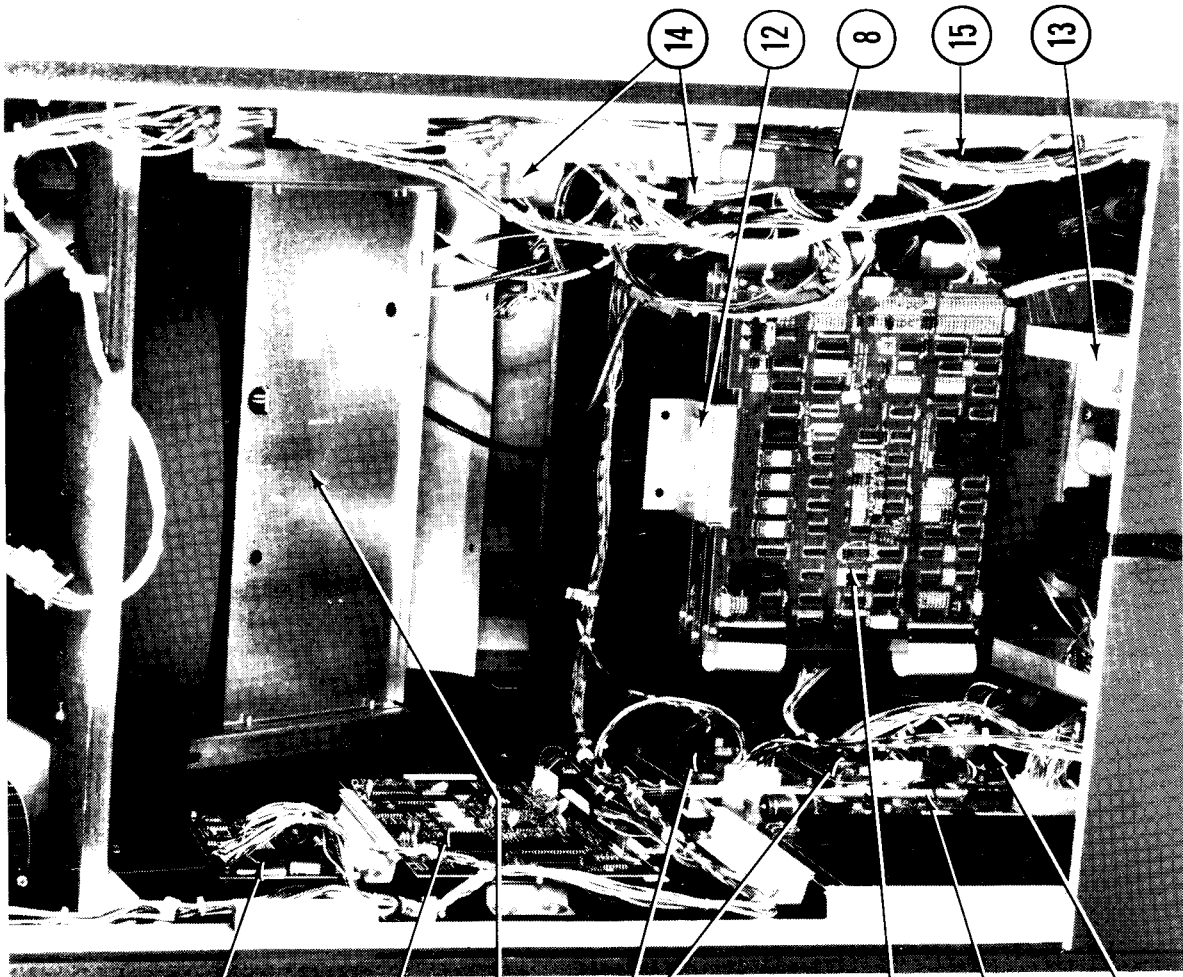

- 1
- 2
- 3
- 4
- 5
- 6
- 7
- 8
- 9
- 10
- 11
- 12
- 13
- 14
- 15
- 16
- 17
- 18
- 19
- 20

NO. 383 - DISCS OF TRON ENVIRONMENTAL - REAR ACCESS - PARTS LIST

ORDER BY PART NUMBER ONLY

ITEM	PART NO.	DESCRIPTION
1	A945-00038-0000	ON-OFF SWITCH & PLATE ASSY.
2	0894-00916-0000	PLASTIC PULL & VENT (2 REQ'D.)
	0017-00101-0141	#8x11/16 UNSLOT HEX HD. M.S. (8 REQ'D.)
3	0383-00904-0000	REAR SCENERY
4	0383-00115-00XF	SCENERY TRAP BRKT. (2 REQ'D.)
	0696-00114-0000	REAR SCENERY BRKT.
5	A696-00040-0000	FLASHING WHITE LIGHT W/O FILTER ASSY.
	A696-00043-0000	FLASHING LIGHT CABLE ASSY.
	MT00-00125-A000	POWER TRANSFORMER - 60 HZ
	0017-00003-0026	BALLAST
	0017-00003-0043	18" COOL WHITE FLUOR. LAMP
	0017-00031-0036	FLUORSCENT SOCKETS (2 REQ'D.)
	0017-00003-0445	FLUOR. LAMP LOCK (2 REQ'D.)
6	0017-00003-0339	ELECTROHOME - 19" COLOR DUAL SYNC HORIZ. MTG. MONITOR (OR)
6	0017-00003-0439	WELLS-GARDNER - 19" COLOR DUAL SYNC HORIZ. MTG. MONITOR (OR)
6	0017-00003-0454	ZENITH - 19" COLOR DUAL SYNC HORIZ. MTG. MONITOR
	0636-00101-0000	MONITOR RAIL (2 REQ'D.)
7	0696-00911-0000	MONITOR SHIELD
8	A088-00016-0000	INTERLOCK SWITCH & SPRING BRKT. ASSY.
	0303-00904-0000	INTERLOCK SWITCH COVER
9	A961-00007-0000	CASTER ASSY. (2 REQ'D.)
10	A945-00019-0000	LINE CORD ASSY. - 115V
11	A383-00015-0000	CARDRACK W/BOARDS ASSY.
	A084-91657-A383	SOUND I/O P.C. BRD. ASSY.
	A639-00060-0000	SHIELD & BARRIER ASSY.
	0017-00101-0134	#6-32x1/4 SLT. HEX HD. M.S. (4 REQ'D.)
	A084-91490-A383	PROGR. CPU P.C. BRD. ASSY.
	A358-00016-0000	SHIELD & SPACER ASSY. - INNER
	A084-91464-A696	VIDEO GENERATOR P.C. BRD. ASSY.
	A358-00017-0000	SHIELD & SPACER ASSY. - OUTER
	0017-00101-0153	#6-32x1" SLT. HEX HD. M.S. (8 REQ'D.)
12	A383-00020-0000	SUPPORT BRKT. ASSY. - TOP OF CARDRACK
13	A945-00020-0000	POWER CHASSIS ASSY. - 125VA., 115V
14	A084-91661-B000	RELAY CONTROL BRD. ASSY. (2 REQ'D.)
	0383-00919-0000	RELAY CONTROL BRD. COVER (2 REQ'D.)
	0383-00920-0000	RELAY CONTROL BRD. SHIELD (2 REQ'D.)
15	A084-91659-C383	FLUOR. CONTROL P.C. BRD. ASSY.
16	A084-91658-C696	LAMP SEQUENCER P.C. BRD. ASSY.
17	A084-91648-A000	DUAL POWER AMP W/MIXER ASSY. (2 REQ'D.)
18	A084-91631-B000	AUXILIARY POWER SUPPLY BOARD
19	A084-91660-C000	SQUAWK & TALK P.C. BRD. ASSY.
20	A084-90412-D000	POWER SUPPLY P.C. BRD. ASSY. - 125V
	0624-00902-0100	P.C. SUPPORT BRKT. -12" LG. (2 REQ'D.)
	0624-00902-0300	P.C. SUPPORT BRKT. -21/2" LG. (2 REQ'D.)
	0624-00902-0500	P.C. SUPPORT BRKT. -61/2" LG. (4 REQ'D.)
	0017-00104-0037	#8 FLAT WASHER (14 REQ'D.)
	0017-00101-0141	#8x11/16 UNSLOT HEX HD. SCREW (42 REQ'D.)

NO. 383 - DISCS OF TRON ENVIRONMENTAL - REAR ACCESS - PARTS LIST

ORDER BY PART NUMBER ONLY

ADDITIONAL PARTS LIST

ITEM	PART NO.	DESCRIPTION
	A383-00007-0000 A383-00009-0000 A941-00008-0000 0017-00009-0490 A097-00009-0000	MASTER CABLE W/BRKT. ASSY. HIGH VOLTAGE CABLE ASSY. LOW VOLTAGE CABLE ASSY. REAR DOOR VENT GRILLE -5-5/8" SQR. (4 REQ'D.) REAR DOOR LOCK ASSY.

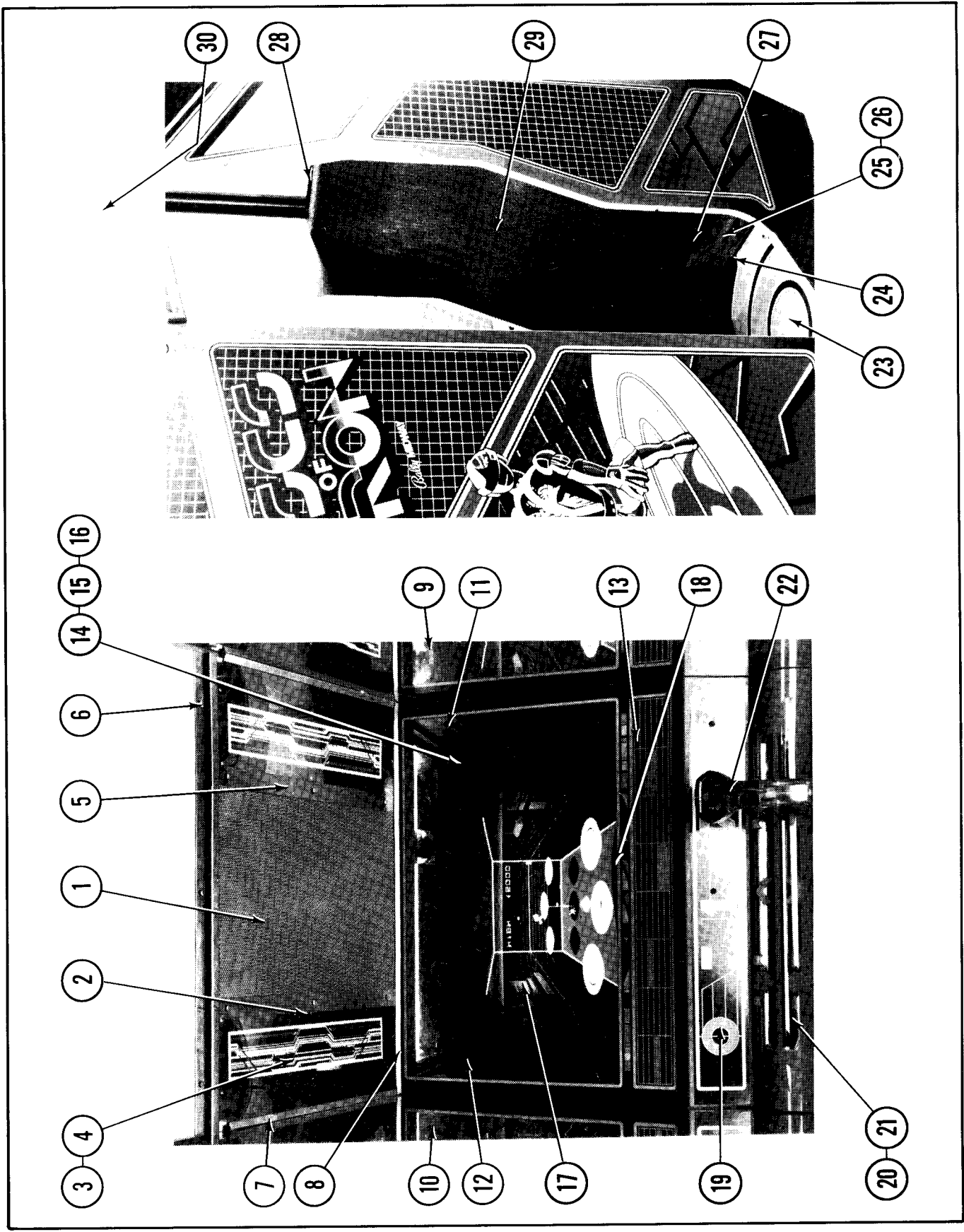

NO. 383 - DISCS OF TRON ENVIRONMENTAL - CONTROL AREA - PARTS LIST

ORDER BY PART NUMBER ONLY

ITEM	PART NO.	DESCRIPTION
1	A383-00023-00XF 0017-00003-0430	SPEAKER BEZEL W/BOLT ASSY. 6"x9" SPEAKER - 4 OHM, 10W (2 REQ'D.)
2	A696-00039-0000 A696-00043-0000	ARENA BLACK LIGHT W/O FILTER ASSY. FLASHING LIGHT CABLE ASSY.
3	0383-00903-00XF 0383-00103-0000	LIGHT INSERT COVER (2 REQ'D.) INSERT BRKT. (4 REQ'D.)
4	0017-00101-0138 0017-00003-0219 0017-00031-0030	#8x5/8 TORX PAN HD. SCREW (16 REQ'D.) #194 WEDGE BASE LAMP - 14V., .27A (10 REQ'D.) WEDGE BASE LIGHT SOCKET (10 REQ'D.)
5	A383-00014-0000 0383-00119-00XF	LIGHT INSERT CABLE ASSY. COVER STRIP (2 REQ'D.)
6	0383-00118-00XF 0017-00101-0138	END CHANNEL #8x5/8 TORX PAN HD. SCREW (9 REQ'D.)
7	0383-00921-0200	CHANNEL - 14-11/16" LG. (2 REQ'D.)
8	0383-00921-0100	CHANNEL - 22-15/16" LG.
9	0383-00916-0100	MIRROR - RIGHT SIDE
10	0383-00916-0200	MIRROR - LEFT SIDE
11	0383-00905-0100	SIDE SCENERY - RIGHT
12	0383-00905-0200	SIDE SCENERY - LEFT
13	0383-00915-00XF	MAIN VIEWING GLASS
14	0383-00913-0000 0696-00110-0000	MIRROPLANE MIRROR HOLD DOWN BRKT. (2 REQ'D.)
15	0383-00901-00XF 0696-00111-0000 0696-00109-0000	SCENERY - RED (NOT SEEN) RED SCENERY HOLD DOWN BRKT. SCENERY HOLD DOWN BRKT.
16	0383-00902-00XF 0696-00110-0000	SCENERY - BLUE (NOT SEEN) HOLD DOWN BRKT. (2 REQ'D.)
17	0383-00904-0000 0383-00924-0000 0383-00115-00XF	SCENERY - REAR SCENERY SUPPORT CHANNEL (2 REQ'D.) SCENERY TRAP BRKT. (2 REQ'D.)
18	0696-00909-0000	MONITOR BEZEL
19	0383-00112-00XF 0017-00101-0138	GLASS RETAINER #8x5/8 TORX PAN HD. SCREW (3 REQ'D.)
20	0383-00912-00XF 0383-00102-0000	LAMP PROTECTOR LAMP SHIELD BRKT.
21	A696-00038-0000 A696-00042-0000 0383-00111-0000 0017-00003-0095 0383-00110-0000 0017-00031-0036 0017-00003-0445	CONTROL SHELF FLUOR. BLK. LIGHT W/O FILTER ASSY. CONTROL LIGHT CABLE ASSY. FLUOR BRKT. 18" BLACK LIGHT LAMP REFLECTOR FLUOR. LAMP SOCKET (2 REQ'D.) LAMP LOCKS (2 REQ'D.)
22	A696-00007-0000	GRIP W/SWITCH ASSY.
23	0383-00909-0000 0383-00106-0000 0017-00101-0138	DECORATIVE FLOOR OVERLAY FLOOR #8x5/8 TORX PAN HD. SCREW (10 REQ'D.)

NO. 383 - DISCS OF TRON ENVIRONMENTAL - CONTROL AREA - PARTS LIST

ORDER BY PART NUMBER ONLY

ITEM	PART NO.	DESCRIPTION
24	0383-00105-00XF	BASE BRKT. (UNDER OVERLAY, NOT SEEN)
25	0383-00910-00XF	LIGHT COVER - REAR
26	A383-00019-0000	FLASHING FOOT LIGHT W/O FILTER ASSY.
27	0383-00113-00XF	CARPET BRACKET - BOTTOM
28	0383-00114-00XF	SLOTTED CARPET BRKT. - TOP
	0017-00101-0138	#8x5/8 TORX PAN HD. SCREW (9 REQ'D.)
29	0383-00918-0000	CARPET - CABINET LINER
	0017-00081-0172	2" WIDE DOUBLE FACE CARPET TAPE
30	0017-00003-0430	6"x9" SPEAKER - 4 OHM, 10W (2 REQ'D.)
		(LOCATED ABOVE CABINET LINER, NOT SEEN)
	0383-00120-00XF	SPEAKER GRILLE - REAR

VISUAL EFFECTS PIECE PART ASSEMBLY

DISC OF TRON
(ENVIR.)

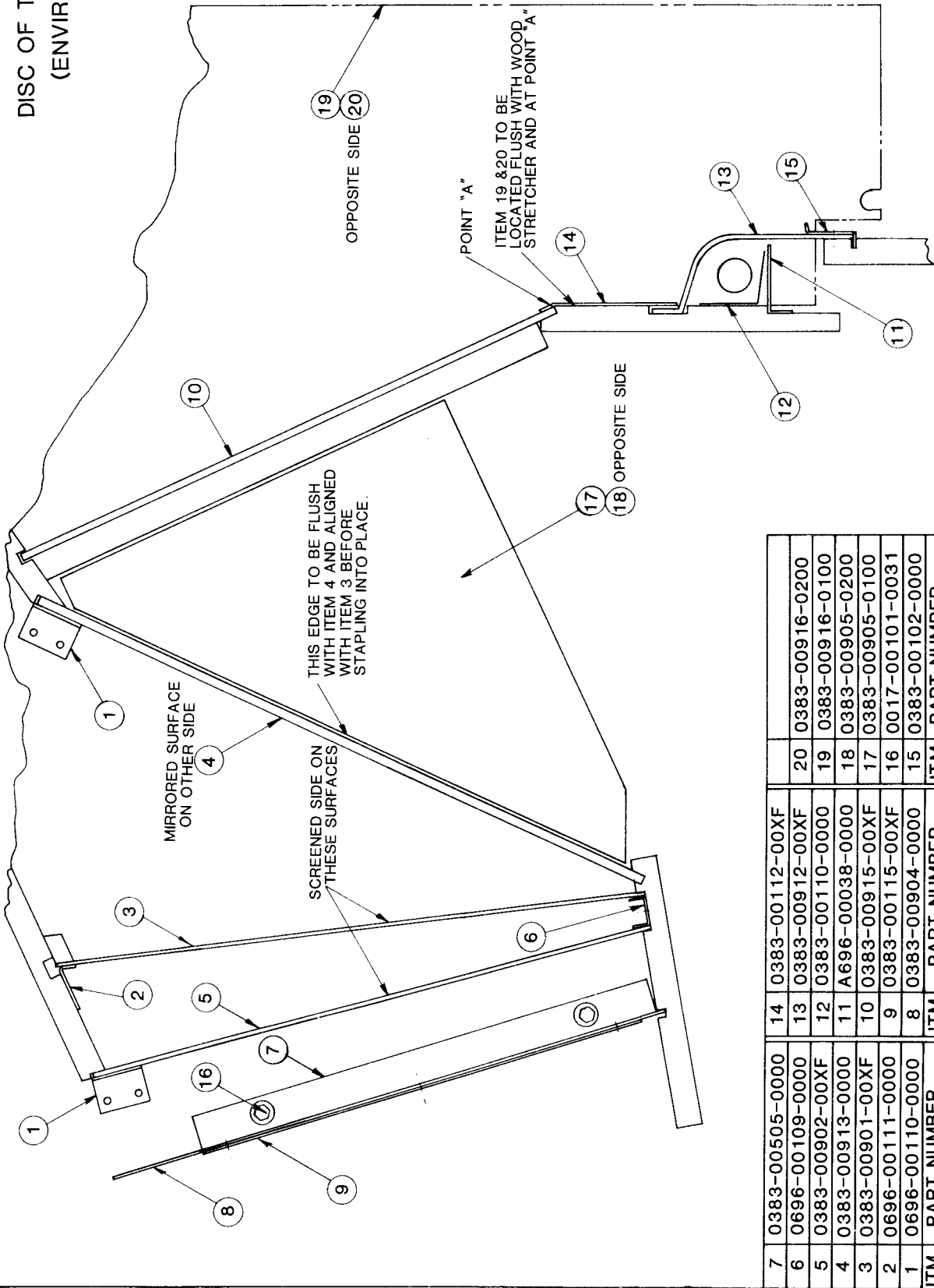

ITM	PART NUMBER	ITM	PART NUMBER	ITM	PART NUMBER
7	0383-00505-0000	14	0383-00112-00XF	20	0383-00916-0200
6	0696-00109-0000	13	0383-00912-00XF	19	0383-00916-0100
5	0383-00902-00XF	12	0383-00110-0000	18	0383-00905-0200
4	0383-00913-0000	11	A696-00038-0000	17	0383-00905-0100
3	0383-00901-00XF	10	0383-00915-00XF	16	0017-00101-0031
2	0696-00111-0000	9	0383-00115-00XF	15	0383-00102-0000
1	0696-00110-0000	8	0383-00904-0000	ITM	PART NUMBER
ITM	PART NUMBER	ITM	PART NUMBER	ITM	PART NUMBER

NO. 696 & 383 - DISCS OF TRON - CONTROL GRIP ASSEMBLY

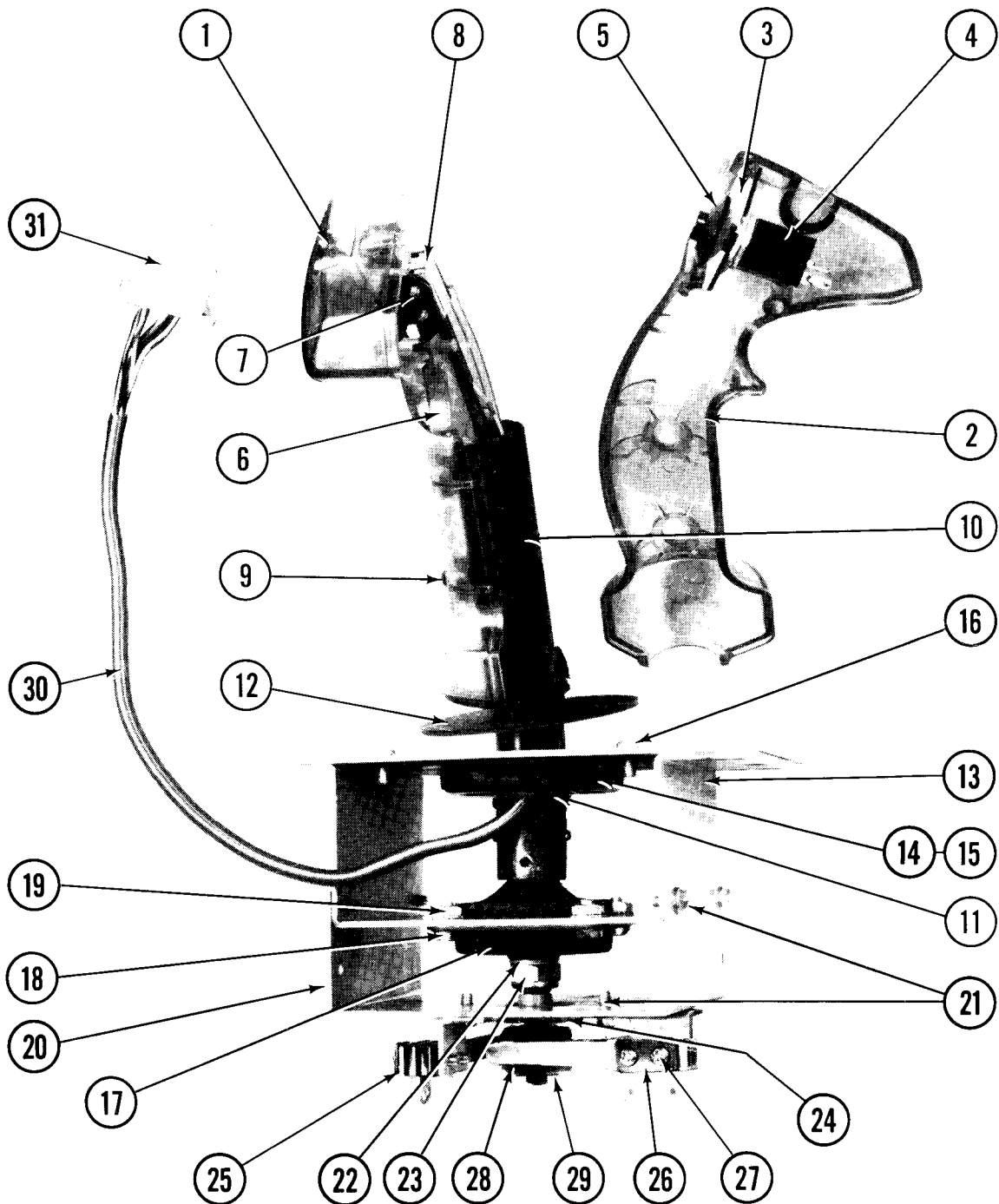

NO. 696 & 383 - DISCS OF TRON - CONTROL GRIP ASSEMBLY - PARTS LIST

ORDER BY PART NUMBER ONLY

ITEM	PART NO.	DESCRIPTION
1	0873-00900-0400	CONTROL GRIP - LEFT
2	0873-00900-0300	CONTROL GRIP - RIGHT
3	0696-00100-0000	GRIP SWITCH PANEL
4	0696-00900-0000	NOTCHED SWITCH
	0017-00104-0112	7/8" INT. WASHER
	0017-00104-0045	3/4" FLAT WASHER
	0017-00103-0089	5/8-24 HEX NUT
5	0929-00905-00XF	SWITCH BEZEL
	A696-00006-0000	GRIP SWITCH PANEL ASSY. (ITEMS 3 THRU 5)
6	0628-00906-0000	TRIGGER
7	0696-00102-00XF	TRIGGER SWITCH BRKT.
	0017-00101-0083	#4-20x3/8 PHIL PAN HD. SCR. (2 REQ'D.)
8	A696-00004-0000	GRIP TRIGGER SWITCH ASSY.
	0020-00202-0000	SWITCH PLATE
	0017-00101-0525	#5-40x9/16 PHIL. RND. HD. M.S. (2 REQ'D.)
9	0017-00101-0149	#10-32x3/8 TORX TAMPER RESISTANT BUTTON HD. SCREW (5 REQ'D.)
10	A696-00019-0000	TUBING TO PIVOT PIN ASSY.
11	0696-00907-0000	SLEEVE
12	0628-00904-0000	SLIDE
13	A639-00020-0000	CENTERING BRKT. WELD ASSY.
14	0873-00113-00XF	BUMPER MTG. BRKT.
15	0873-00910-0000	BUMPER
16	0017-00101-0615	#8-32x3/8 SLT. PAN HD. M.S. (4 REQ'D.)
17	0628-00905-0000	GROMMET
18	0017-00101-0799	#10-32x3/8 SLT. HEX HD. M.S. (4 REQ'D.)
19	0017-00103-0081	#10-32x5/16 HEX NUT W/SEMS (4 REQ'D.)
20	A696-00025-0000	STOP PLATE & SWITCH BRKT. ASSY.
21	0017-00101-0598	#8-32x5/16 SLT. HEX HD. M.S. (6 REQ'D.)
22	0017-00104-0034	5/8" FLAT WASHER
23	0017-00103-0102	7/16-14 LOCK NUT
24	0639-00906-0000	WEAR PLATE
25	A355-00003-0000	MOLDED SWITCH ASSY. (4 REQ'D.)
26	0020-00202-0000	SWITCH PLATE (4 REQ'D.)
27	0017-00101-0527	#5-40x5/8 PHIL. RND. HD. M.S. (8 REQ'D.)
28	0921-00700-0000	ACTUATOR
29	0017-00100-0025	1/4" E-RING
30	0010-00266-0100	STRAIN RELIEF EXT. SPRING
31	0017-00021-0311	6 PIN CONNECTOR
	0017-00103-0011	#10-32 LOCK NUT (4 REQ'D.) MOUNTS ASSEMBLY TO CONTROL SHELF

NO. 696 & 383 - DISCS OF TRON - OPTICAL ENCODER KNOB ASSEMBLY

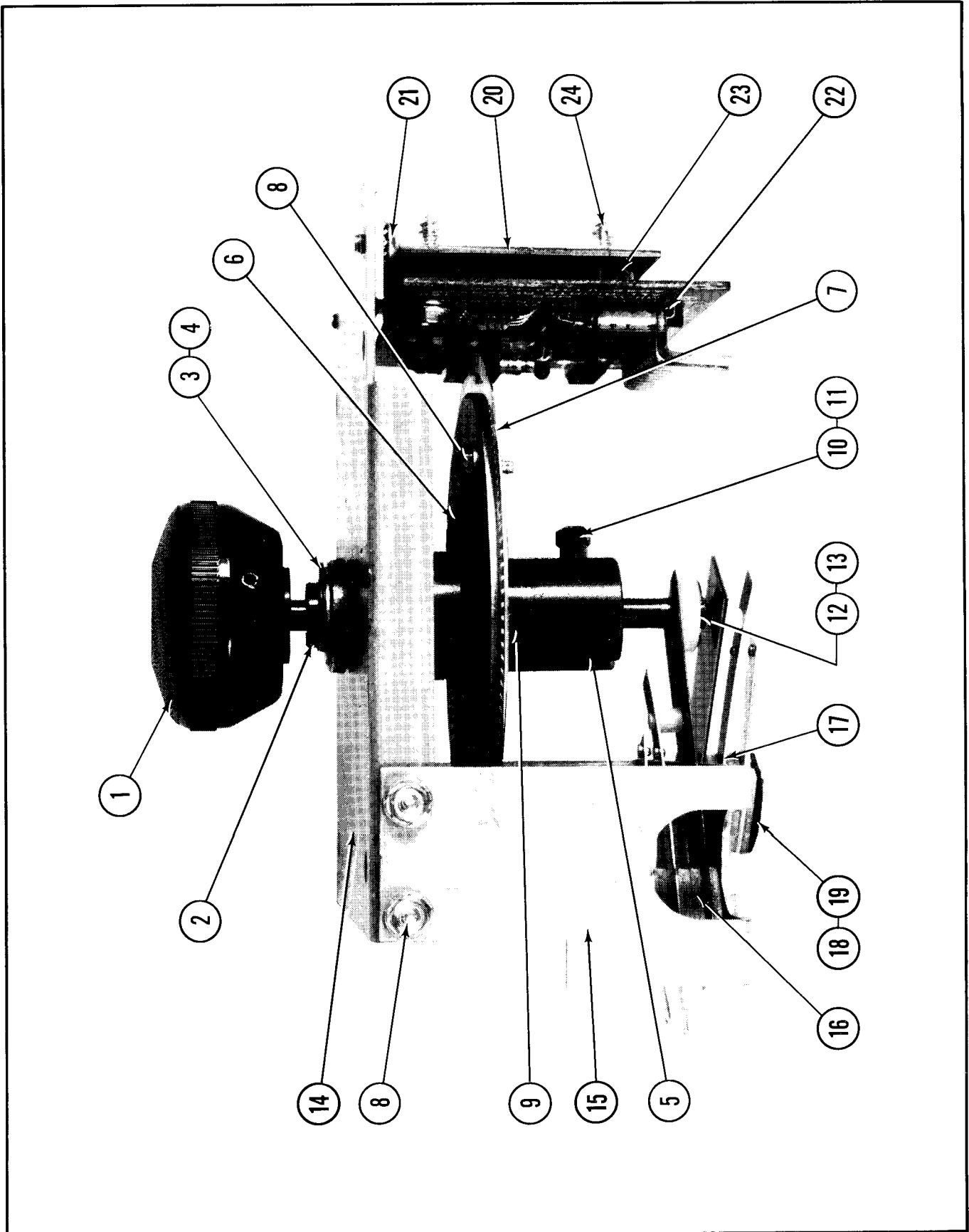

NO. 696 & 383 - DISCS OF TRON - OPTICAL ENCODER KNOB ASSEMBLY - PARTS LIST

ORDER BY PART NUMBER ONLY

ITEM	PART NO.	DESCRIPTION
1	A696-00029-0000	KNOB & SHAFT ASSEMBLY
2	0696-00703-00XF	MAIN SHAFT
3	0017-00100-0050	1/2" E-RING (2 REQ'D)
4	0017-00104-0045	3/4" FLAT WASHER
5	A696-00031-0000	HUB & BOTTOM PLATE ASSY.
6	0696-00103-0000	TOP PLATE
7	0628-00900-0000	SENSOR DISC
8	0017-00101-0124	#6x1/4 UNSLOT HEX HD. M.S. (7 REQ'D.)
9	0017-00101-0791	#8-32x1/4 HEX HD. SET SCREW (2 REQ'D.)
10	0639-00705-00XF	STOP STUD
11	0639-00911-0000	ROLLER SLEEVE
12	0696-00702-0000	SWITCH ACTUATOR
13	0017-00100-0025	1/4" E-RING
14	A696-00016-0000	BEARING TO BUSHING/BRKT. ASSY.
15	0696-00105-0000	SWITCH MOUNTING BRKT.
16	A696-00018-0000	LEAF SWITCH ASSY.
17	A696-00030-0000	LOWER SWITCH LEAF ASSY.
18	0020-00202-0000	SWITCH PLATE (2 REQ'D.)
19	0017-00101-0528	#5-40x3/4 PHIL. RND. HD. SCREW (4 REQ'D.)
20	0696-00113-0000	ENCODER P.C. BRD. MTG. BRKT.
21	0017-00101-0586	#8-32x3/16 SLT. PAN HD. M.S. (2 REQ'D.)
22	A084-91482-A000	OPTICAL ENCODER P.C. BRD.
23	0017-00042-0072	PLASTIC GROMMET (4 REQ'D.)
24	0017-00101-0027	#8x3/4 SLT. HEX HD. WD. SCR. (4 REQ'D.)
	0017-00103-0011	#10-32 LOCK NUT (4 REQ'D.) MOUNTS ASSEMBY TO CONTROL SHELF

POWER CHASSIS ASSY.—125VA., 115V.—PARTS LIST

ORDER BY PART NUMBER **ONLY**

ITEM	PART NO.	DESCRIPTION
1	A945-00046-00XF	CHASSIS & PARTITION ASSY.
2	A945-00029-0100	MTG. PLATE & BARRIER ASSY.
3	0945-00107-01XF	STRAP (2 REQ'D.)
4	0017-00101-0123	#8 x 1/4 UNSLOT. HEX HD. SCR. (12 REQ'D.)
5	MT00-00101-A000	ISOLATION TRANSFORMER W/O SHIELD ASSY. — 115V., 50/60 HZ.
	0017-00103-0061	#8-32 HEX NUT W/SEMS (4 REQ'D.)
6	MT00-00099-A000	POWER TRANSFORMER ASSY. — 115V., 60 HZ.
	0017-00103-0084	#6-32 HEX NUT W/SEMS (4 REQ'D.)
7	0175-181T4-GXJK	CAPACITOR — 3.5 M.F., 440V.
8	0017-00009-0535	CLAMP
	0017-00101-0565	#6-32 x 7/16 SLT. PAN HD. SCR.
	0017-00103-0084	#6-32 HEX NUT W/SEMS
9	0017-00101-0067	#6 x 3/8 PHIL. PAN HD. SCR. (11 REQ'D.)
10	0945-00902-0000	SNAP BUSHING (3 REQ'D.)
11	0017-00021-0297	2 POSITION CONNECTOR
12	A945-00030-0100	CONNECTOR & CABLE ASSY. #1
13	A945-00030-0200	CONNECTOR & CABLE ASSY. #2
14	A945-00021-0000	CONVENIENCE OUTLET ASSY.
15	0017-00101-0573	#6-32 x 1/2 PHIL. RND. HD. SCR. (2 REQ'D.)
	0017-00103-0084	#6-32 HEX NUT W/SEMS (2 REQ'D.)
	A945-00025-0000	FILTER ASSEMBLY — 125V. — UNDER CHASSIS (NOT SEEN)
16	0017-00021-0510	TERMINAL STRIP
17	0017-00101-0140	#4-40 x 5/16 PHIL. PAN HD. SCR. (2 REQ'D.)
18	0017-00003-0263	SLO-BLO FUSE — 4A., 250V.
19	0017-00003-0005	FUSE — 2A., 250V.
	0017-00003-0444	QUICK CONN. FUSEHOLDER (2 REQ'D.) — FOR ABOVE FUSES
20	0945-00816-1902	CAPACITOR — 100,000 M.F.
21	0945-00816-1901	CAPACITOR — 55,000 M.F.
	0017-00104-0107	#10 FLAT WASHER (4 REQ'D.)
	0017-00103-0081	#10-32 HEX NUT W/SEMS (4 REQ'D.)
22	0017-00009-0422	CLAMP (2 REQ'D.)
	0017-00101-0758	#8-32 x 3/4 PHIL. RND. HD. SCREW (2 REQ'D.)
	0017-00103-0061	#8-32 HEX NUT W/SEMS (2 REQ'D.)
23	0017-00101-0067	#6 x 3/8 PHIL. PAN HD. SCR. (6 REQ'D.)
24	0945-00904-0000	5 POSITION FUSE HOLDER
	0017-00003-0263	SLO-BLO FUSE — 4A., 250V.
	0017-00003-0217	SLO-BLO FUSE — 2.5A., 250V. (2 REQ'D.)
	0017-00003-0007	SLO-BLO FUSE — 3A., 250V. (2 REQ'D.)
	0945-00903-0000	FUSE HOLDER BARRIER
	A945-00022-0000	HEATSINK & DIODE ASSY.
	0017-00101-0067	#6 x 3/8 PHIL. PAN HD. SCR. (2 REQ'D.)
25	0017-00101-0780	#6 x 1/2 PHIL. PAN HD. SCREW (2 REQ'D.)
	0017-00021-0629	5 POSITION TERMINAL STRIP — (UNDER CHASSIS)
	A945-00019-0000	LINE CORD ASSY. — 115V. (NOT SHOWN)
26	A945-00030-0500	CONNECTOR & CABLE ASSY.
27	0017-00101-0660	#10-32 x 3/4 PAN HD. SCREW
	0017-00104-0107	#10 FLAT WASHER
	0017-00103-0081	#10-32 HEX NUT W/SEMS

FRONT DOOR ASSEMBLY - U.S.A. 25¢

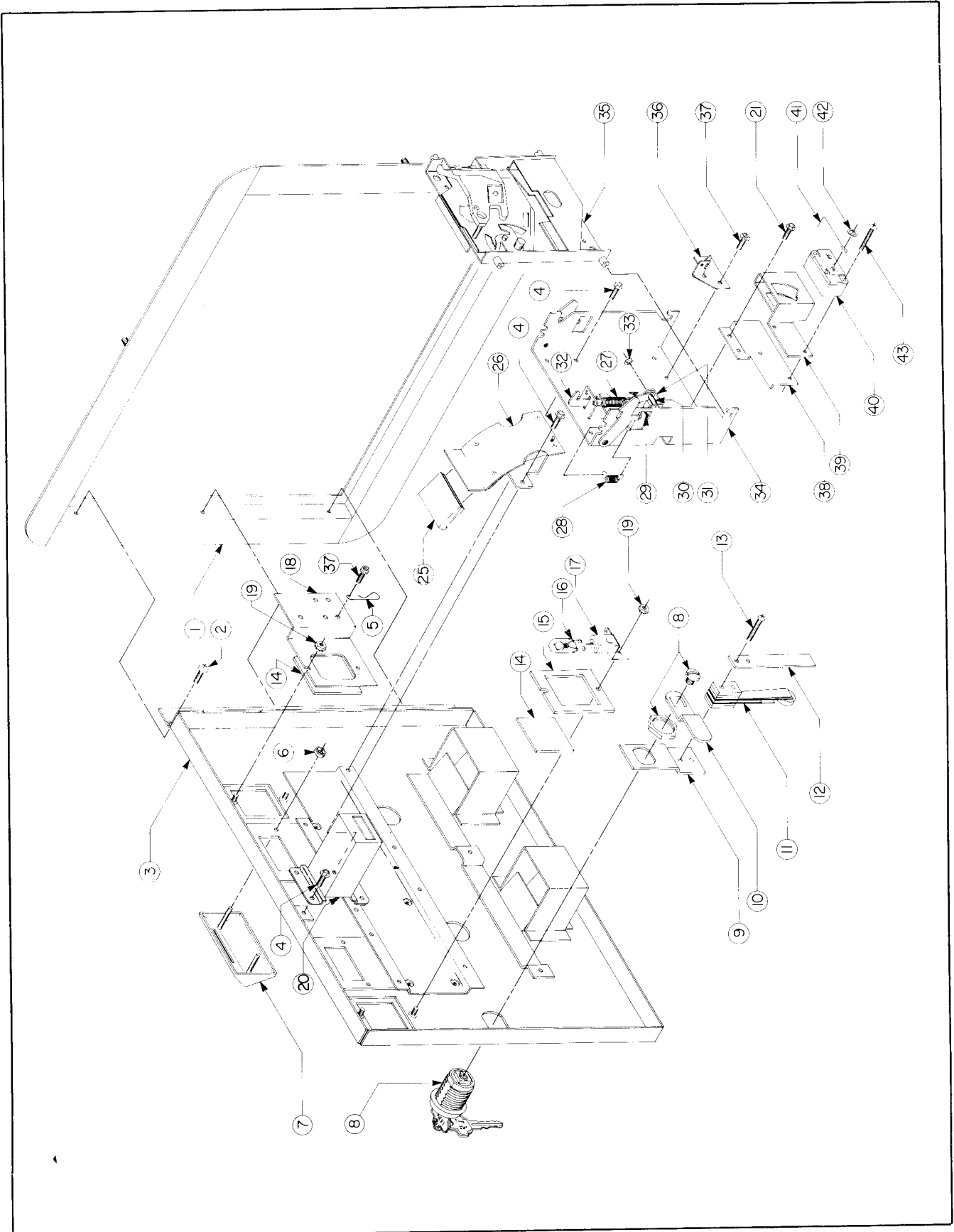

FRONT DOOR ASSEMBLY — U.S.A. 25¢ — PARTS LIST

ORDER BY PART NUMBER ONLY

ITEM	PART NO.	DESCRIPTION
1	0090-00002-04BK	DOUBLE ENTRY COIN DOOR FRAME
2	0017-00101-0121	#6-32 x 5/16 PHIL. TRS. HD. SCR. (3 REQ'D.)
3	A090-00073-02BK	DOUBLE ENTRY COIN DOOR W/DRESS PLATE
4	0017-00101-0123	#8 x 1/4 UNSLOT. HEX HD. SCREW (12 REQ'D.)
5	0017-00007-0019	KEY HOOK
6	0017-00103-0059	PUSH NUT (4 REQ'D.)
7	0090-00912-0000	COIN ENTRY PLATE — 25¢ (2 REQ'D.)
8	A097-00005-0000	DOOR LOCK & KEY W/SCREW & NUT (OR)
8	A097-00006-0000	DOOR LOCK & KEY W/SCREW & NUT
9	0090-00128-00XF	DOOR TILT SWITCH BRKT.
10	0017-00005-0041	DOOR CAM
11	A090-00095-0000	DOOR TILT SWITCH
12	0090-00126-03XF	SWITCH BACK-UP PLATE
13	0017-00101-0525	#5-40 x 9/16" PHIL. HD. M.S. (2 REQ'D.)
	A090-00096-0000	DOOR TILT SWITCH & BRKT. ASSY. (ITEMS 9 & 11 THRU 13)
14	0090-00903-9500	25¢ WINDOW (2 REQ'D.)
15	0090-00143-00XF	COIN PLEX RETAINER
16	0017-00003-0219	12 VOLT LAMP — G.E. #194 (2 REQ'D.)
17	0017-00031-0048	WEDGE SOCKET W/BRKT. (2 REQ'D.)
18	A090-00100-0000	BRKT. ASSY.
19	0017-00103-0084	#6-32 HEX NUT W/SEMS (4 REQ'D.)
20	A090-00089-0000	COIN METER W/DIODE
21	0017-00101-0124	#6 x 1/4 UNSLOT. HEX HD. SCR. (4 REQ'D.)
25	0090-00911-0000	INSULATOR (2 REQ'D.)
26	A090-00112-0000	COIN CHUTE & INSULATOR ASSY. (2 REQ'D.)
27	0010-00134-0000	SPRING
28	0010-00181-0000	SPRING
29	0017-00007-0083	1/8 x 1-5/8 ROLL PIN
30	0090-00129-00XF	PIVOT POST
31	0090-00167-00XF	PIVOT LEVER
32	0090-00182-00XF	REJECT LEVER
33	0017-00100-0018	E-RING
	A090-00088-0000	REJECT LEVER ASSY. (2 REQ'D.) (ITEMS 30 THRU 33)
34	A090-00115-0000	COIN ACCEPTOR FRAME ASSY. (2 REQ'D.)
35	0017-00005-0003	COIN ACCEPTOR W/STRING CUTTER (2 REQ'D.) (OR)
35	0017-00005-0211	COIN ACCEPTOR W/ANTI STRING DEVICE (2 REQ'D.) (OR)
35	0017-00005-0214	COIN ACCEPTOR W/STRING CUTTER (2 REQ'D.)
36	A090-00064-0000	ANTI-PENNY DEVICE
37	0017-00101-0099	#6 x 1/4 SLT. HEX HD. M.S. (2 REQ'D.)
38	0090-00162-00XF	COIN SWITCH MTG. BRKT.
39	0017-00005-0203	COIN SWITCH CHUTE
40	0017-00005-0195	COIN SWITCH
41	0010-00599-0000	COIN SWITCH WIRE
42	0017-00007-0015	PUSH-ON RING
	A090-00059-0400	COIN SWITCH & WIRE ASSY. (ITEMS 40 THRU 42)
43	0017-00101-0147	#4-40 x 3/4 PHIL. PAN. HD. M.S. (2 REQ'D.)
	A090-00077-0000	COIN GUIDE & SWITCH ASSY. (ITEMS 38 THRU 43)

III. Wiring Diagrams & Schematics

DISC OF TRON

OPTION SWITCH SETTINGS

//////////SWITCH NO. 1 - AT B 3 - LOCATED ON SOUND I/O P.C. BOARD//////////

DURING GAME PLAY:	SW#1	SW#2	SW#3	SW#4	SW#5	SW#6	SW#7	SW#8	SW#9	SW#10	
	NOT USED	NOT USED	NOT USED	NOT USED	NOT USED	NOT USED	ON	NOT USED	NOT USED		
UPRIGHT / MINI COCKTAIL TABLE								ON			
								OFF			
** FREEZE VIDEO NORMAL OPERATION									ON	OFF	

//////////SWITCH NO. 3 - AT D 14 - LOCATED ON SOUND I/O P.C. BOARD//////////

** NORMAL OPERATION SOUND I/O DIAGNOSTIC MODE	SW#1	*SW#2	*SW#3	*SW#4
	OFF			
	ON			
** NORMAL OPERATION RAM/ROM TEST INDICATES TEST RESULTS VIA YELLOW LED ON SOUND I/O BOARD: FAST FLASH = BAD ROM SLOW FLASH = BAD RAM		OFF		
		ON		
** NORMAL OPERATION OSCILLATOR TEST			OFF	
			ON	
** NORMAL OPERATION FILTER TEST				OFF
				ON

NO EFFECT IF SW#1 OF SWITCH NO. 3 IS IN THE "OFF" POSITION.
* FACTORY RECOMMENDED SETTINGS.

PART NO. M051-00383-A007

THE REMAINDER OF YOUR NEW GAME'S MOST COMMON OPTION SETTINGS ARE CONDUCTED DURING THE MACHINE SETUP PORTION OF THE SELF-TEST MODE AND WILL BE COVERED IN DETAIL IN THAT SECTION OF YOUR MANUAL.

FLUOR. LITE WIRING DIAGRAM

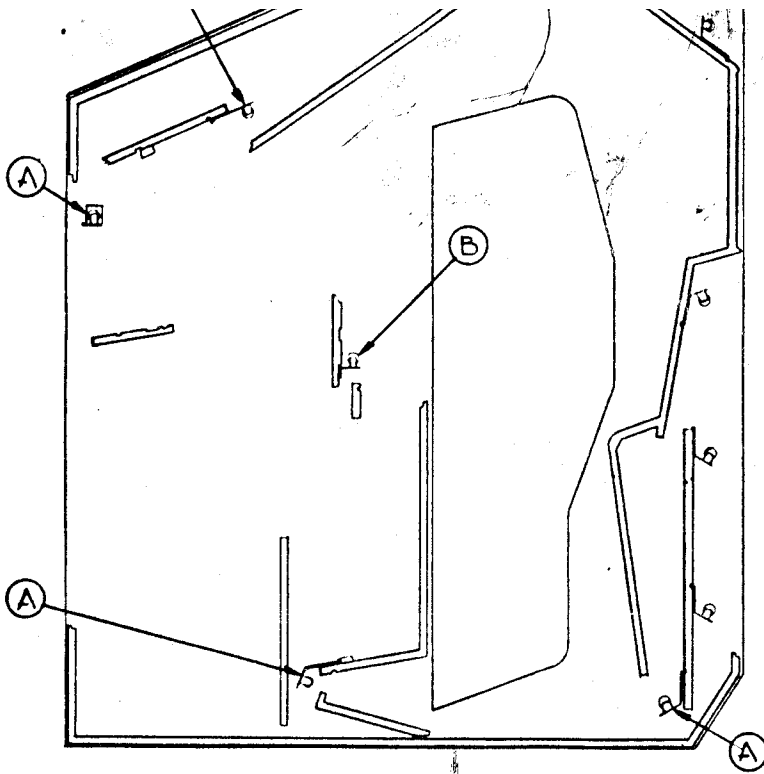

See the DIAGRAMS below for the appropriate WIRING SEQUENCE for each FLUOR. LITE as indicated.

FIG. 1

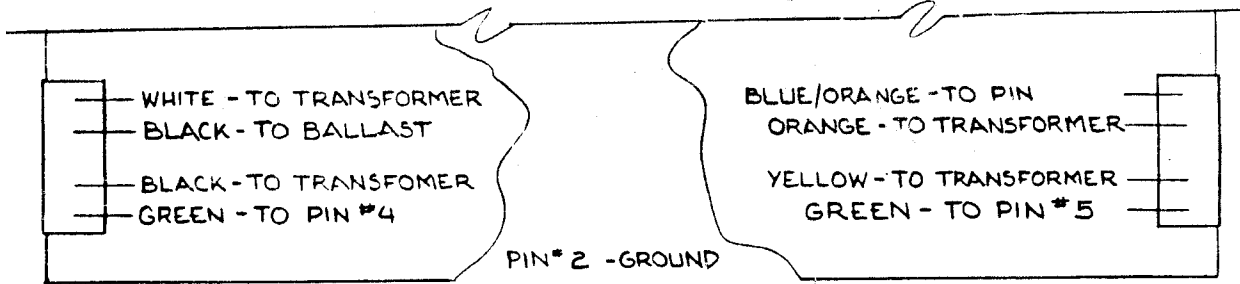

WIRE DIAGRAM "A"

