

This document has been downloaded from:



The largest resource for amusement machines  
documentation on the world wide web!



**FLIPPERSPILL.COM**

# **FUTURE FLASH**

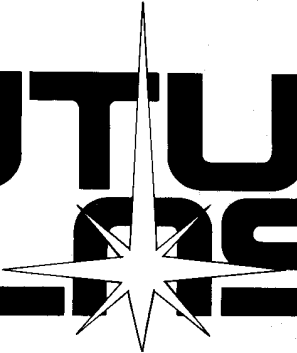

**MODEL FF-001U**

## **SERVICE MANUAL**

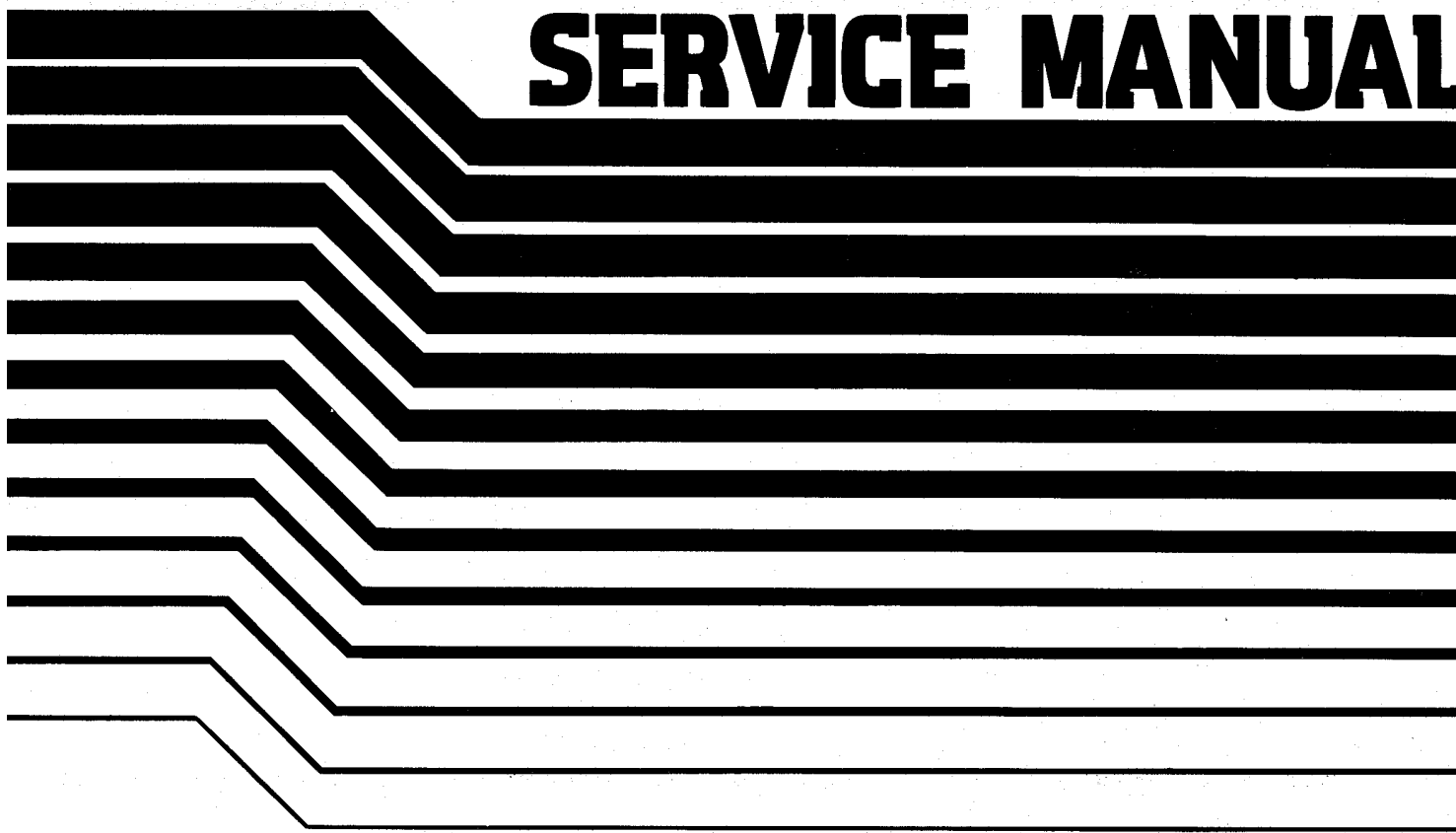

# CONTENTS

1. SPECIFICATIONS .....	1
2. OPERATIONAL INSTRUCTIONS .....	1
3. HOW TO PLAY THIS GAME .....	2
4. GAME INSTRUCTIONS .....	3
5. GAME BOARD CONTROL LOCATIONS AND METHOD ....	4
6. TROUBLE SHOOTING .....	5
7. PARTS DIAGRAM	
OUTSIDE VIEW .....	6
INSIDE VIEW .....	7
8. PARTS LIST .....	8 ~ 10
● WIRING DIAGRAM .....	11
● SCHEMATIC DIAGRAM .....	12 ~ 17

---

# 1. SPECIFICATIONS



Input power source	Single-phase AC 100V, 110V, 117V, 220V, 240V change-over, 50/60Hz
Power consumption	120W
Dimensions	W860 x D560 x H630 ~ 720 mm
Weight	kg
Coin(s) used	2000 coins (100 yen coins)
CRT monitor	20" (with smoke mask)
Power cord	3 m in length (single-phase; 3 poles, with one pole earthed)

---

# 2. OPERATIONAL INSTRUCTIONS

- (1) Install the machine on a flat floor which is not subjected to vibrations, etc.
- (2) When applying voltage on the machine, do not use the same wall outlet as the one for motors, air conditioners, etc. which tend to fluctuate the voltage or produce noise.
- (3) Be sure to turn off the power switch before replacing the base board or removing the connector carefully.
- (4) Since there are many high voltage parts on the base board of and inside the TV set, never touch those parts.







# 3. HOW TO PLAY THIS GAME

- (1) Insert a coin(s) and press either 1-or 2-PLAYER BUTTON.
- (2) Turn the right-hand ball to adjust the sight (  ) at the enemy missile, and by pressing the FIRE BUTTON destroy the enemy – you can score points.
- (3) Once the FIRE BUTTON has been pressed, the sight mark (  ) remains at the same position even when the sight has been moved – your missile will reach the position flying to destroy the enemy missile.
- (4) When all the enemy missiles have been destroyed, the game proceeds to the next round.
- (5) When all of your fighters have been destroyed, the game is over.
  - ★ Scoring 10,000 points (or 30,000 points when the DIP SW3 is turned ON) awards another fighter.
  - ★ Each time when 4 rounds have been completed, you are awarded an EXTRA GAME as a bonus.

<EXTRA GAME>

- The ground surface disappears, and meteorites and the enemy fighters will come to assault your position. Destroy them by launching your missiles.
- When your fighter(s) remain undestroyed, you are awarded another fighter.
- The farther the meteorite or the enemy fighter away from your fighter, the more points you can score when destroying any of them – you are awarded points between 300 and 1,000.
- When the EXTRA GAME is over, the game returns to the starting mode.

— SCORE —

Enemy Missile					Enemy Mother Ship	Bom from the Enemy Mother Ship
						
No. 1 0 pts.	No. 2 20 pts.	No. 3 30 pts.	No. 4 40 pts.	No. 5 50 pts.	300 pts plus 10 missiles	5 pts.

[Bonus Points at Each Round]

- ★ Per your undestroyed missile ..... 5 pts
- ★ Per your undestroyed fighter ..... 100 pts x No. of round(s)

---

## 4. GAME INSTRUCTIONS

- The enemy mother ship does not drop a bomb at the ordinary (DIP SW 2 = OFF) round 1 alone.
- The enemy missile runs away off a cloud appearing when your missile has exploded. The enemy missile runs away quickly in order of No. 5, No. 4 and No. 3; No. 1 and No. 2 will not run away at any round of the game.
- The larger the number of rounds, the larger becomes the number of enemy missiles. But since the number of missiles of the friendly force does not increase, it is necessary to destroy multiple enemy missiles by one missile.
- The pattern of the surface of the earth changes by every 4 rounds. There are 8 patterns of the earth surface, and there are 4 kinds of the fighter planes for the friendly force.
- Since the number of missiles of the friendly force by each round is 60, when all of the missiles are discharged, it is impossible to make attacks on the enemy. On the 4th, 8th . . . round, 100 missiles are made available for the friendly force. If the missiles of the friendly force still remain on these rounds, the remaining number of the friendly force's missiles are carried forward to the following extra game.

# 5. GAME BOARD CONTROL LOCATIONS AND METHOD

## (1) ADJUSTMENT OF DIP SW

SW NO.	SW Explanation	SW Condition	Description
SW1	Upright type/Table type Reversing	ON OFF	Upright type Table type
SW2	Content of the game	ON OFF	Difficult Easy
SW3	Addition of ally fighter(s)	ON OFF	Over 30,000 pts for an additional fighter Over 10,000 pts for an additional fighter
SW4	Sound on demonstration	ON OFF	Sound-on Sound-off
SW5 SW6	Coin mech. 2	OFF OFF	1 coin for 1 play (1 game)
SW5 SW6	Coin mech. 2	<i>on</i> OFF OFF ON	2 coins for 1 play (1 game)
SW5 SW6	Coin mech. 2	<i>off</i> ON ON OFF	3 coins for 1 play (1 game)
SW5 SW6	Coin mech. 2	ON ON	Free
SW7 SW8	Coin mech. 1	OFF OFF	1 coin for 1 play (1 game)
SW7 SW8	Coin mech. 1	<i>on</i> OFF OFF ON	1 coin for 2 plays (2 games)
SW7 SW8	Coin mech. 1	<i>off</i> ON ON OFF	1 coin for 3 plays (3 games)
SW7 SW8	Coin mech. 1	ON ON	1 coin for 6 plays (6 games)

## (2) OPERATION OF SERVICE SW

Pushing the service SW, you can play the game without inserting a coin. In this case, coin counter is not added.

---

## 6. TROUBLESHOOTING

- Before considering some phenomenon as a trouble, confirm the matters listed below and then contact your dealer.
- The video game machine is broadly divided as to electrical component into four sections, namely, the monitor section, game PCB, operating section and power source section, which are connected with one another by wiring. If any one of them develops a trouble the game machine as a whole will not work normally. When you think that there is something wrong with the machine, check for the machine just for a little while before consulting your dealer since an apparent trouble may sometimes be caused by a trifling mistake or misunderstanding which can be remedied by a modicum of repairs.
- When the machine has developed any trouble, it must first be found out which part of the four sections and the wiring is malfunctioning. When you have guessed the malfunctioning part, check for each section. If the checked part shows no abnormal signs, check for other parts related to it, too.
- Is the fuse not blown ? (Be sure to use the indicated fuse. If a renewal fuse is also blown, then the other part is out of order.)
- Is the connector unfirmly contacted or disconnected ? Since connector's poor contact is conceivable in all trouble cases thoroughly check the connector for contact condition (Be sure to turn the power off before mounting or demounting the connector.)
- Sometimes normal images cannot be produced despite turning ON the power cord plug. This can sometimes be corrected by setting the control circuit. So, repeat turning ON and OFF the power a few times.
- When checking for the meters, switches, etc. by means of a circuit tester, be sure to pull out the IC board connector.



# 7. PARTS DIAGRAM

## • OUTSIDE VIEW

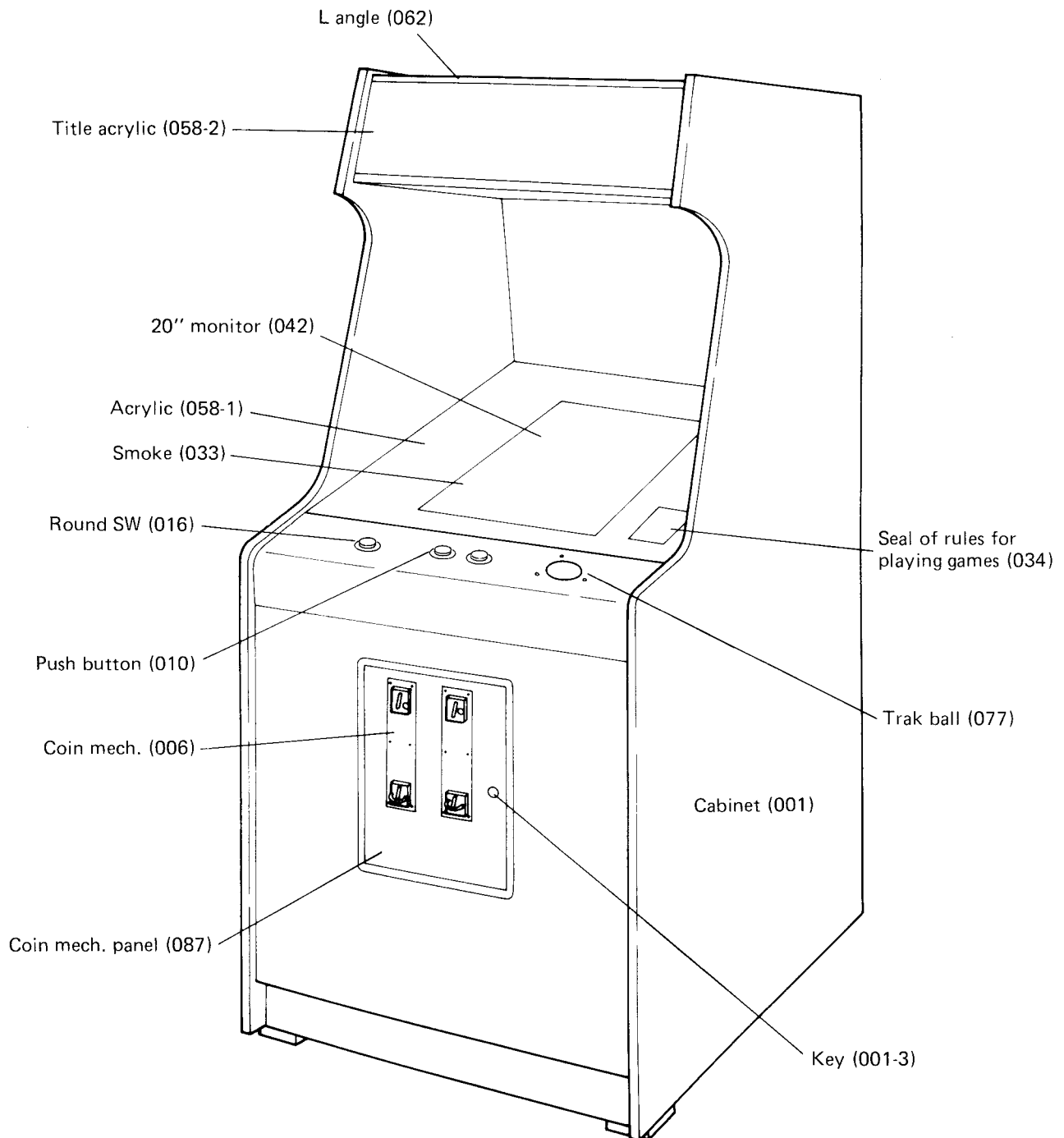

• INSIDE VIEW

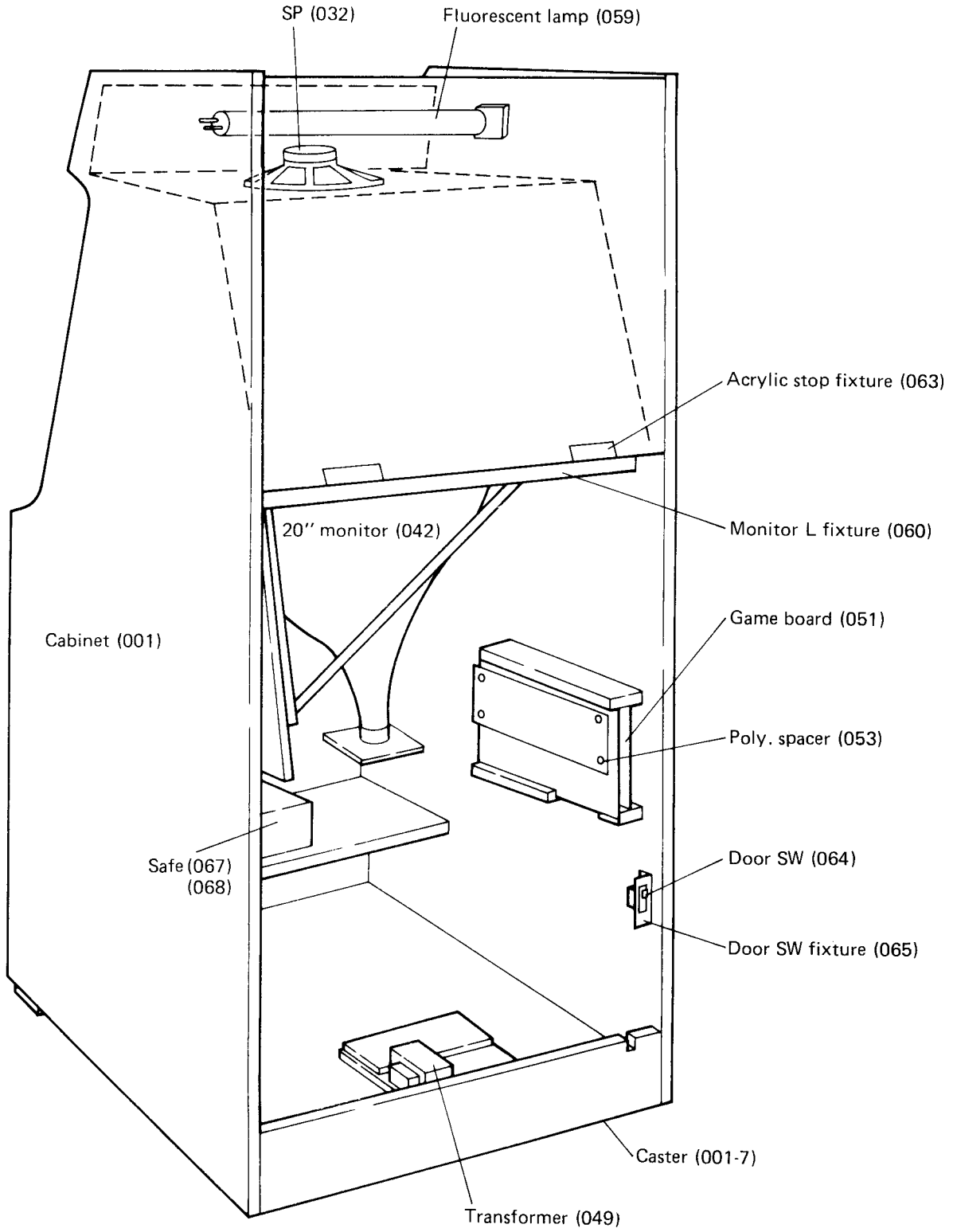

# 8. PARTS LIST

Symbol	Nomenclature	Description	Quantity	Remark
001	Cabinet		1	
058-1	Acrylic, large	588x667	1	
058-2	Acrylic, small	588x178	1	
033	Smoke	Brown 2t , 588x667		
032	SP			
059	Fluorescent lamp			
042	20" monitor			Deflection opposite to Galaxian
049	Power transformer			
060	Monitor L fixture		2	
061	SP salan fixture		1	
062	L angle		2	
045	Triangular ideal		4	
063	Acrylic stop fixture		2	
064	Door SW			
065	Door SW fixture			
006	Coin mech.	M75	2	
066	Safe panel		1	
068	Safe chassis		1	
021	Service SW		1	
001-3	Short key	For safe panel	1	
020	Coin counter		2	
069	Power source fixture		1	
030	Noise filter		1	
029-1	Fuse holder	Placed type		
031	3A fuse	6φ	1	
070	2P terminal board		1	
			1	
027	Cord bush		1	
025	AC receptacle		2	
050	Power source base board unit	SLT-PS	1	Including mounted parts
048	Power source Ass board		1	
008	Operating panel		1	
071	Handle box		1	
071-1	Leaf spring spacer		2	
071-2	Leaf spring		2	
071-3	Handle lever		1	
071-4	Handle shaft		1	
071-5	Lever pin		1	
071-6	Potbelly pin	8φ	1	
071-7	R pin	4φ	1	
015	Black ball 35φ		1	
019	Long lever micro SW		4	

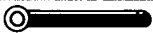
Symbol	Nomenclature	Description	Quantity	Remarks
012	Blind	10.5φ – 40φ	1	
016	Pushbutton (Round SW)	Red: 016-R (White: 016-W)	1	1 red (1 white)
017	Pushbutton fixture	For UP	2	
018	Spacer ring		2	
010	Push button SW		2	
041	Blower	EP88BZL	1	
051	Game board		1 set	
072	Black paper for monitoring		1 set	
073	Patching lock		2	
034	Seal of play instructions		1	
054	Base board stopper		1	
053	Poly. one touch spacer		4	
055	50-core flat			
056	34-core flat			
057	Mech. micro SW			
042-1	Signaling lead wire	Attached to monitor		
042-2	AC cord	Attached to monitor		
042-3	Short plug	Attached to monitor		
001-7	Caster	Attached to cabinet		
022	Service SW fixture			
074	UCC-100	Coin board	1	
111	4x30	Half round	6	
112	4x15	Half round	12	
128	4x25		4	For SP
129	5x18		4	For monitor
117	4 flanges		22	
130	5 flanges		4	
115	4x6	Double seams		
131	5 washers		4	For monitor
114	3x15		8	
132	3x8		2	For handle box
133	3 nuts		2	For handle box
134	3 washers		2	For handle box
116	3x6 seams		4	
118	3.5x10	Truss head tap	40	
119	3.5x16	Truss head tap	20	
120	3.1x12	Black round head wood screw	10	
125	3.5x27 – 31		6	
121			20	

Symbol	Nomenclature	Description	Quantity	Remarks
124	Binding band		25	
126	Oval lug	5 $\phi$	1	
075	8-direction lever ass'y		1	
077	Trak ball		1	
077- 1	Acrylic board		1	
2	Steel board (above)		1	
3	Steel board (below)		1	
4	Aluminum A		1	
5	" B		1	
6	" C		1	
7	Hexagonal shaft		1	
8	Spacer		4	
9	Shaft		2	
10	L fixture		1	
11	15 – 6	Ball bearing	5	
12	4 nut metal	Flat nut	3	
13	4 x 8 Pan head	Double seams	9	
14	4 x 8 Counter-sunk		7	
15	67 washer		2	For shaft adjustment
16	2.6 nut		8	
17	3 x 8	Seams	2	
18	Photo coupler	P507A BL	4	
19	6 nut		1	
20	6 x 18		1	
21	8 – 6 – 1.5	Washer	1	
22	Bakelite board		2	
24	4 x 20	Seams	4	
25	Ball	57 $\phi$ 168g	1	
26	Ring plate		2	
27	2.6 x 8	Round head	8	

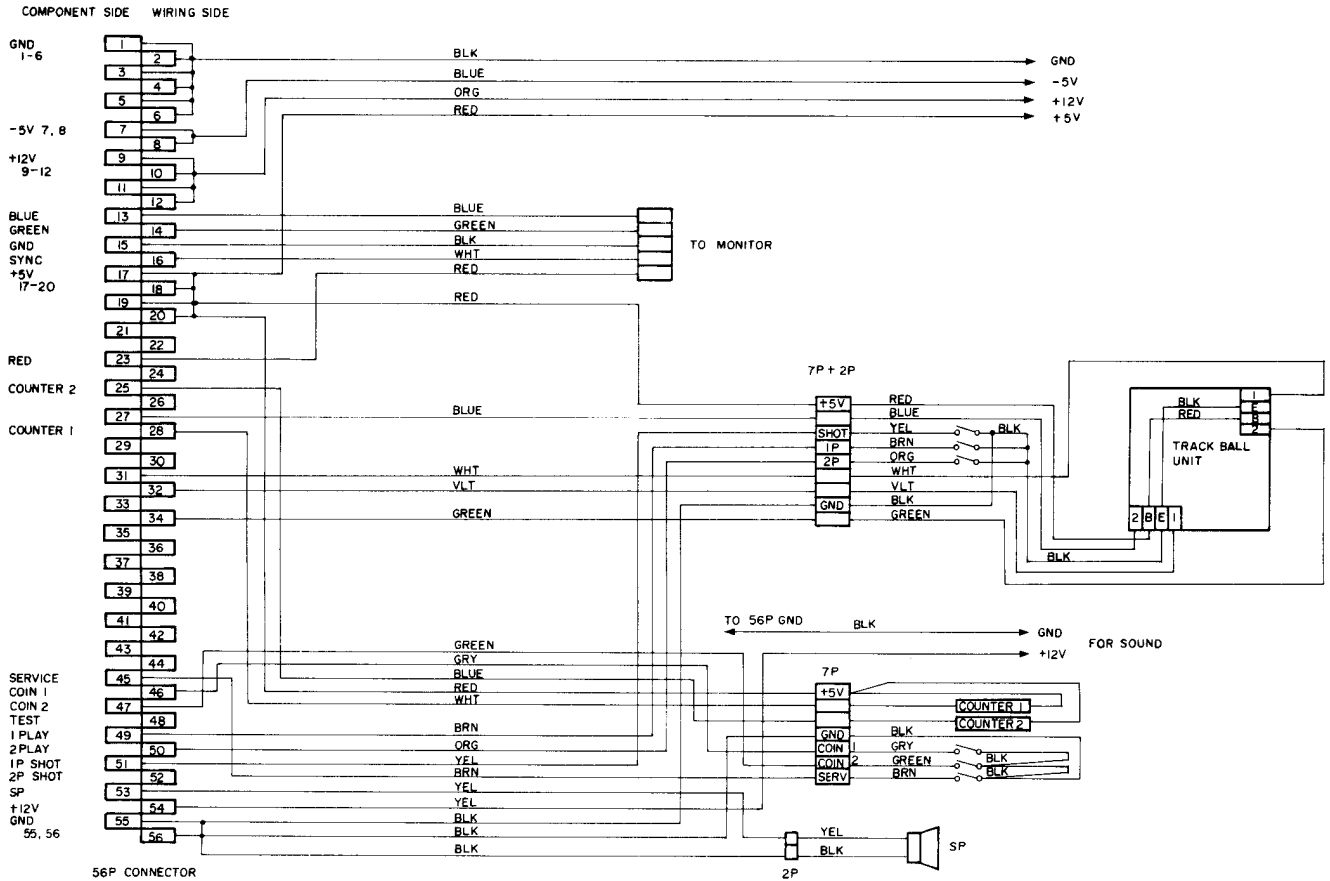
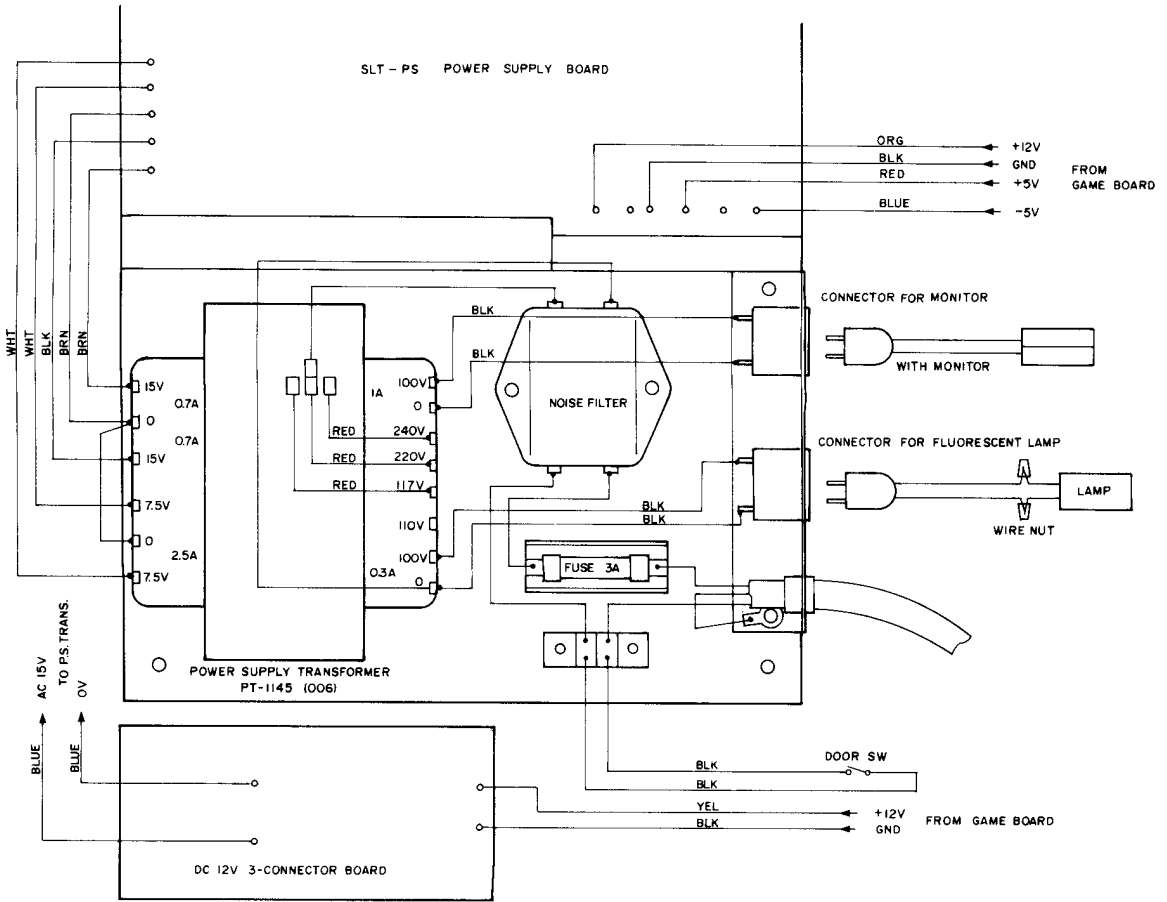



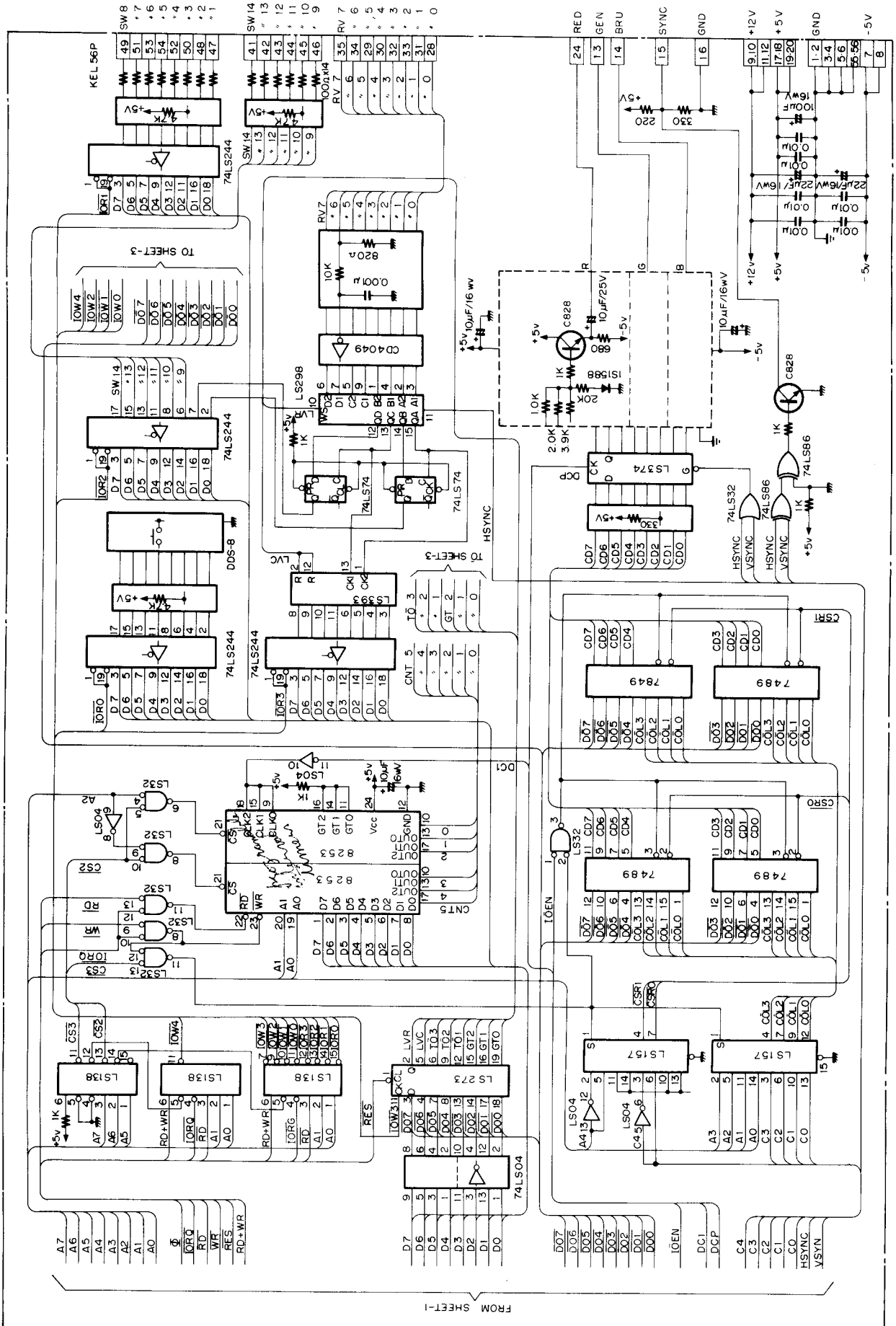



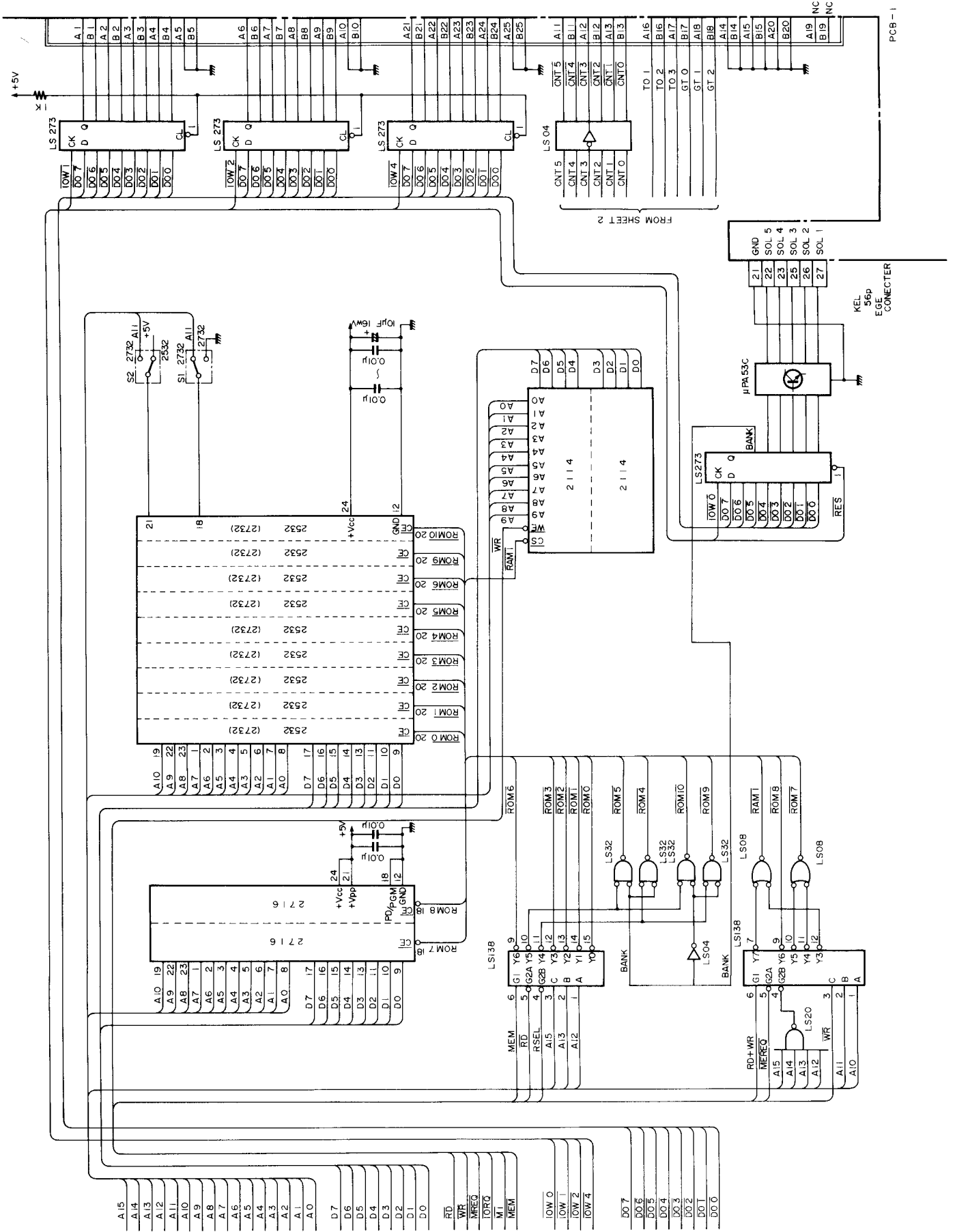

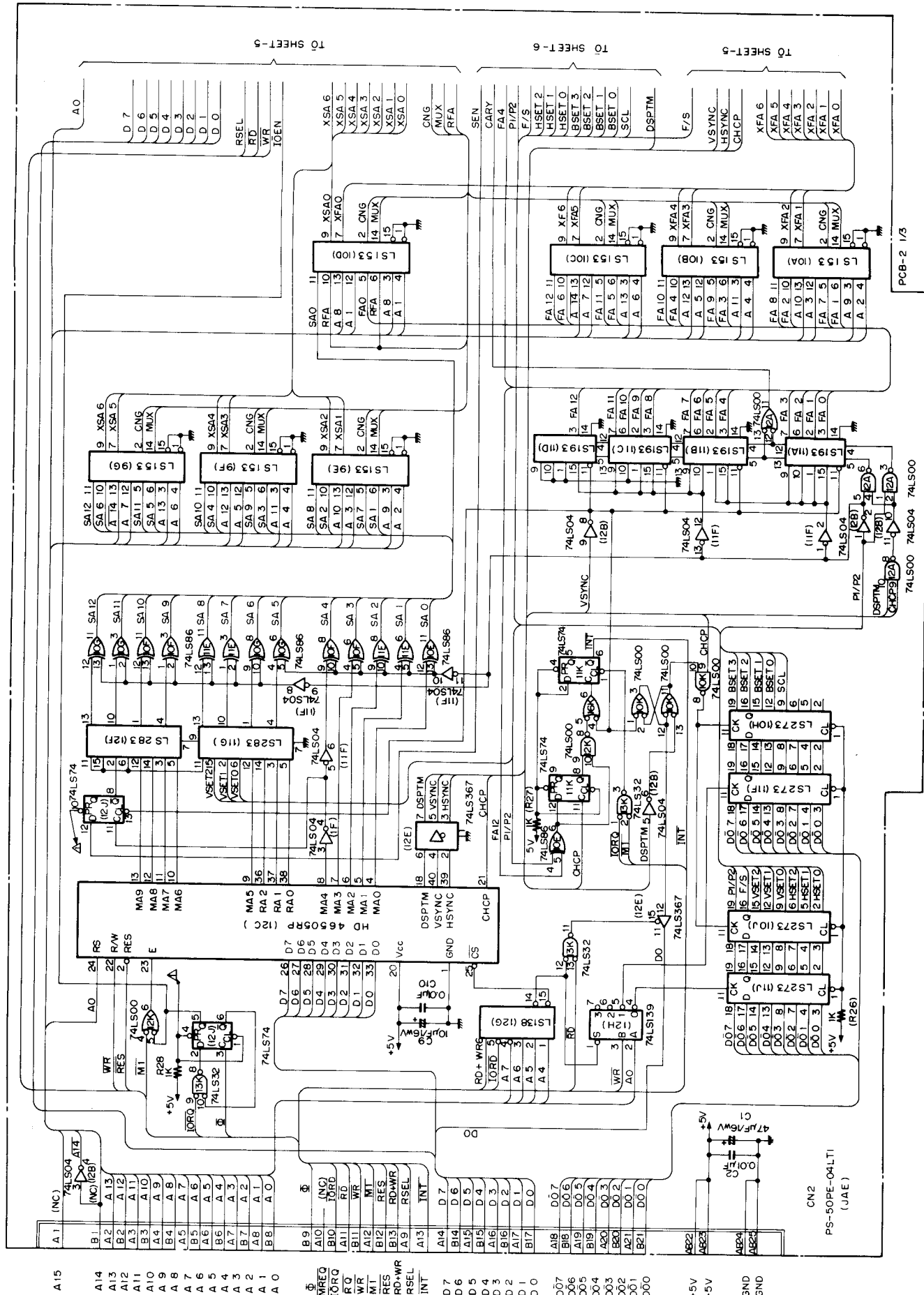

- A15 (NC)
- A14 (NC)
- A13 (NC)
- A12 (NC)
- A11 (NC)
- A10 (NC)
- A9 (NC)
- A8 (NC)
- A7 (NC)
- A6 (NC)
- A5 (NC)
- A4 (NC)
- A3 (NC)
- A2 (NC)
- A1 (NC)
- B9 MREQ
- B10 IORQ
- B11 RD
- B12 WR
- B13 RES
- B14 RD+WR
- B15 RSEL
- B16 INT
- B17 D7
- B18 D6
- B19 D5
- B20 D4
- B21 D3
- B22 D2
- B23 D1
- B24 D0
- B25 D07
- B26 D06
- B27 D05
- B28 D04
- B29 D03
- B30 D02
- B31 D01
- B32 D00
- B33 +5V
- B34 +5V
- B35 GND
- B36 GND
- B37 +5V
- B38 +5V
- B39 GND
- B40 GND
- B41 +5V
- B42 +5V
- B43 GND
- B44 GND
- B45 +5V
- B46 +5V
- B47 GND
- B48 GND
- B49 +5V
- B50 +5V
- B51 GND
- B52 GND
- B53 +5V
- B54 +5V
- B55 GND
- B56 GND
- B57 +5V
- B58 +5V
- B59 GND
- B60 GND
- B61 +5V
- B62 +5V
- B63 GND
- B64 GND
- B65 +5V
- B66 +5V
- B67 GND
- B68 GND
- B69 +5V
- B70 +5V
- B71 GND
- B72 GND
- B73 +5V
- B74 +5V
- B75 GND
- B76 GND
- B77 +5V
- B78 +5V
- B79 GND
- B80 GND
- B81 +5V
- B82 +5V
- B83 GND
- B84 GND
- B85 +5V
- B86 +5V
- B87 GND
- B88 GND
- B89 +5V
- B90 +5V
- B91 GND
- B92 GND
- B93 +5V
- B94 +5V
- B95 GND
- B96 GND
- B97 +5V
- B98 +5V
- B99 GND
- B100 GND

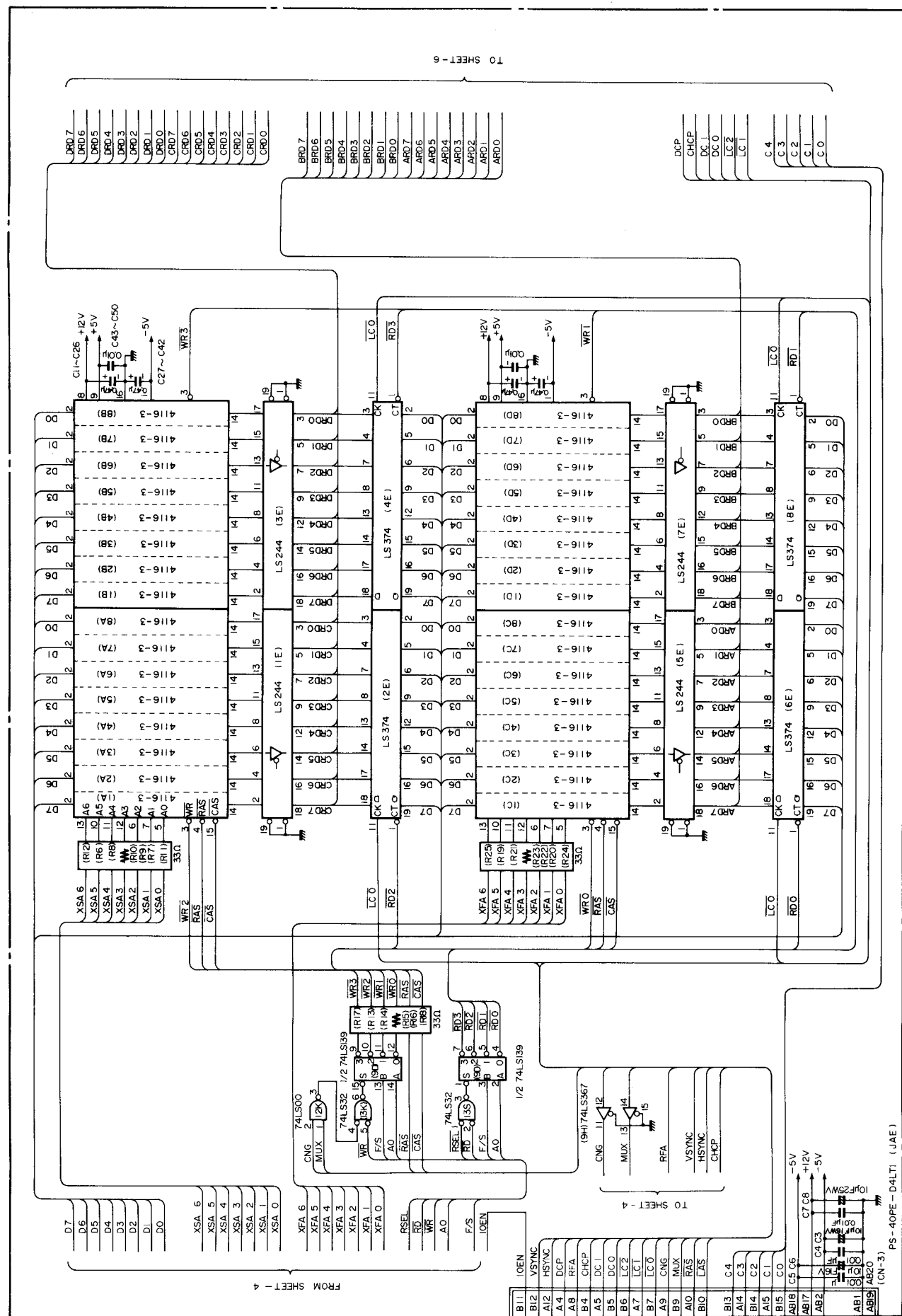

TO SHEET - 6

PCB - 2 2/3

PS - 40PE - D4LT. (JAE)

(CN-3)

