

This document has been downloaded from:



The largest resource for amusement machines
documentation on the world wide web!



FLIPPERSPILL.COM

namco[®]

POINT BLANK 3 KIT

**CONNECTIONS
AND
TEST ROUTINE**

This kit comprises of the following items:

<u>Quantity</u>	<u>Description</u>	<u>Part No</u>
1	Point Blank 3 System 11 PCB Assembly	XPB3-GAMEPCB
1	Point Blank 3 Universal Header Decal	40000645
1	Point Blank 3 Universal Instruction Decal	40000646
1	Gun Assembly - Red	XPB-GUNRED
1	Gun Assembly - Blue	XPB-GUNBLUE
1	20way JAE Connector - PS-D4C20 with wires	69200065
1	Connection / Test Manual	90500122

Connectors - Game PCB Assy

15way High Density 'D' Connector
(Video)

<u>Pin</u>	<u>Function</u>
1	Video Red
2	Video Green
3	Video Blue
5	Video Ground
13	Composite Sync
Shell	Screen

Part No

Connector 66000013
Case 66000001
Terminals 66500008

3way Amp EI Connector
(Game Control)

<u>Pin</u>	<u>Function</u>
1	1P Game
2	2P Game
3	Ground

(Pin 1 Must be connected to Pin 3)

Part No

Connector 66000710
Terminals 66500024

12way Amp Mini Plug
(Low Voltage In)

<u>Pin</u>	<u>Function</u>
1	+5v
2	+12v
3	+24v
4	Ground
5	+5v
6	+12v
7	+24v Ground
8	Ground
9	+5v
10	+12v
11	Ground
12	+24v Ground

Part No

Connector 66000667
Terminals 66500014

15way Amp Mini Plug
(Guns)

<u>Pin</u>	<u>Function</u>
1	+24v
2	+24v
3	+12v
4	+5v
5	+5v
6	Gun 1 Solenoid
7	Gun 1 Trigger
8	Ground
9	Gun 1 Sensor
10	Player 1 Lamp
11	Gun 2 Solenoid
12	Gun 2 Trigger
13	Ground
14	Gun 2 Sensor
15	Player 2 Lamp

Part No

Connector 66000668
Terminals 66500014

20way JAE Connector
(Switches)

<u>Pin</u>	<u>Function</u>
A1	Coin Meter
B1	Ground
A2	Left Speaker +
B2	Left Speaker -
B5	+12v
A6	Service Sw
B6	Test Sw
A7	Coin 1
B7	Coin 2
A8	1P Start Sw
B8	2P Start Sw
A9	Right Speaker +
B9	Right Speaker -
A10	Ground
B10	Ground

This Connector is Supplied
as part of the Kit

Test Mode

1. Slide the test switch "ON". The "Menu Screen" will be displayed on the monitor.
2. Pressing the Player 1 switch will step through the tests and pressing Player 2 switch will select the test.
3. After testing is completed slide the Test switch OFF.

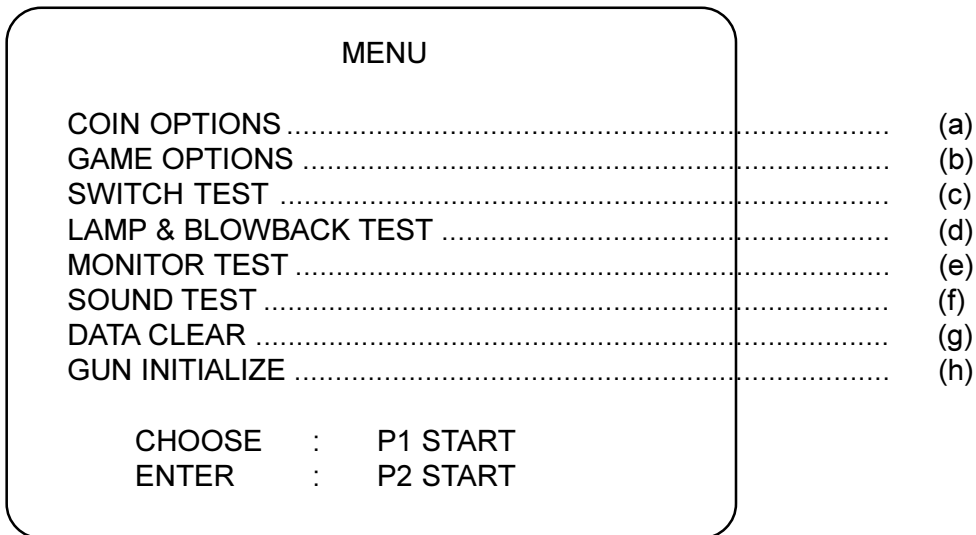

- (a) Sets price of play.
- (b) Sets the game options.
- (c) Test the switches.
- (d) Tests the lamps and gun blowback (recoil).
- (e) Allows testing and set-up of the monitor.
- (f) Adjusts the sound volume.
- (g) Initializes the stored bookkeeping data.
- (h) Sets gun aim alignment

Coin Options

1. Pressing the Player 1 Start Button will step through the Options.
2. Press the Player 2 Start Button to select the option to be changed.
3. Press the Player 1 Start Button to change the Option data.
4. Press the Player 2 Start Button to store the new data value.
5. Press the Player 1 Start Button to select another option or select EXIT and press the Player 2 Start Button to return to the MENU screen.

COIN OPTIONS	
START COST:	
1 COIN TO START	(a)
CONTINUE COST:	
1 COIN TO CONTINUE	(b)
COIN CHUTE 1 VALUE:	
1 COIN COUNT AS 1 COIN	(c)
COIN CHUTE 2 VALUE:	
1 COIN COUNT AS 1 COIN	(d)
FREE PLAY:	
NO	(e)
EXIT	
CHOOSE :	P1 START
ENTER :	P2 START

- (a) Coins required for 1 game. (settable 1 ~ 9.)
- (b) Coins required to continue another game. (settable 1 ~ 9)
- (c) Coins added for coin chute 1. (settable 1 ~ 9)
- (d) Coins added for coin chute 2. (settable 1 ~ 9)
- (e) Setting of Free Play. If Free Play is on, squeezing the gun trigger will start a game.

Note: *When using a CashFlow acceptor the price of play is set within the CashFlow. Ensure that options (a) ~ (d) are set at 1.*

Game Options

1. Pressing the Player 1 Start Button will step through the Options.
2. Press the Player 2 Start Button to select the option to be changed.
3. Press the Player 1 Start Button to change the Option data.
4. Press the Player 2 Start Button to store the new data value.
5. Press the Player 1 Start Button to select another option or select EXIT and press the Player 2 Start Button to return to the MENU screen.

GAME OPTIONS

LIFE : 3 (a)

MUSIC IN ATTRACT : YES (b)

RANKINGPASSWORD : ON (c)

EXIT

CHOOSE : P1 START
ENTER : P2 START

- (a) Number of Player Lives. (settable 1 ~ 5)
- (b) Sound played during Attract Mode. (Yes / No)
- (c) Not used on this game

Switch Test

1. Press Player 1 and Player 2 Start Buttons together to return to the MENU screen

GAME OPTIONS			
P1 TRIGGER	: OFF	P2 TRIGGER:	OFF
P1 START	: OFF	P2 START	: OFF
SERVICE	: OFF	COIN 1	: 0
		COIN 2	: 0
TEST SWITCH	: ON		
DIP SW1	: OFF	DIP SW5	: OFF
DIP SW2	: OFF	DIP SW6	: OFF
DIP SW3	: OFF	DIP SW6	: OFF
EXIT : P1 & P2 START			

OFF changes to ON when the corresponding Switch is operated.

The value of COIN 1 will increase each time credit is established from the CashFlow.

Lamp and Blowback Test

1. Select the test required by pressing the Player 1 Start Button.
2. Press Player 1 Start Button to select another test or select EXIT and press the Player 2 Start Button to return to the MENU screen.

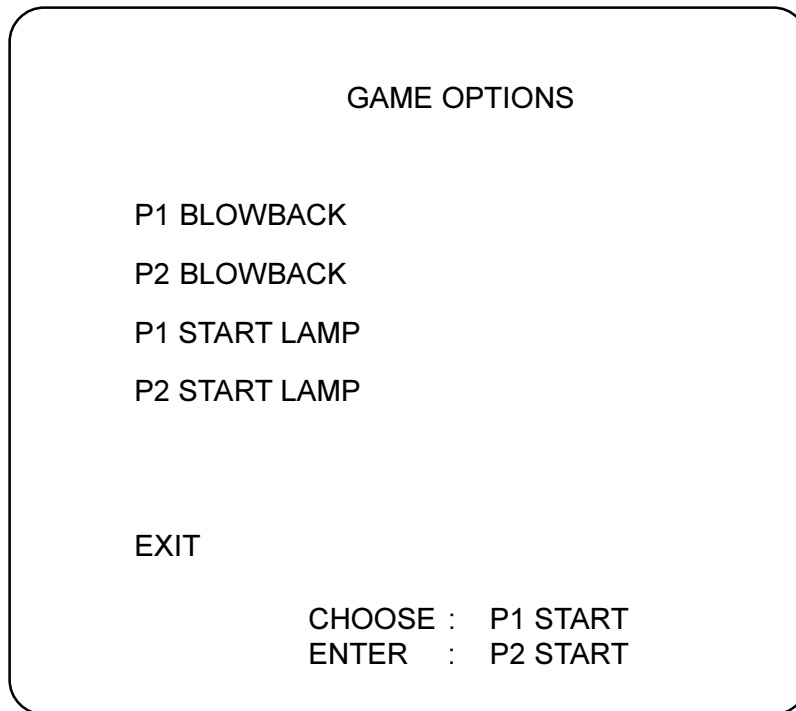

- When P1 or P2 Blowback is selected, pressing the P2 Start Button will activate the Blowback (Recoil) on the corresponding gun.
- When P1 or P2 Start Lamp is selected, pressing the P2 Start Button will cause the corresponding Start Button to blink on and off. Pressing P2 Start Button again will turn the lamp off.

Monitor Test

On entering Monitor Test from the Menu screen a Colour Bar is displayed on the monitor.

Pressing P1 Start Button will toggle between the Colour Bar screen and a Convergence (crosshatch) screen.

COLOUR BAR

Four colour bars are displayed (white, red, green, and Blue) with gradations.

Change the number of gradation steps (32,16,8,4,and 2) by pressing the P2 Start Button

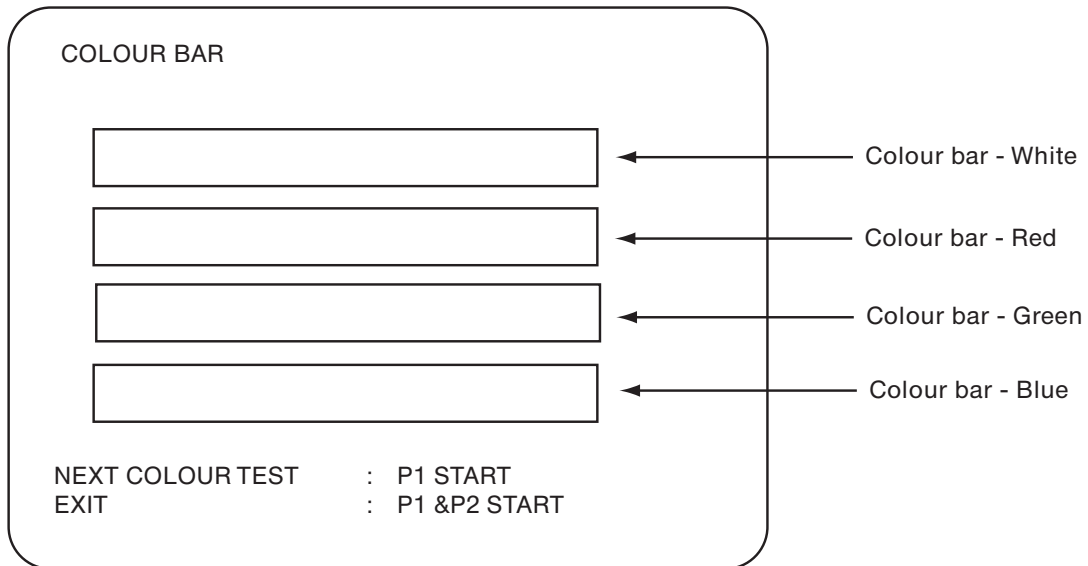

CONVERGENCE (Crosshatch pattern)

A single colour crosshatch pattern is displayed.

Change the colour of the crosshatch pattern (White, Red, Green and Blue) by pressing the P2 Start Button

Press P1 and P2 Start Buttons together to return to the MENU screen.

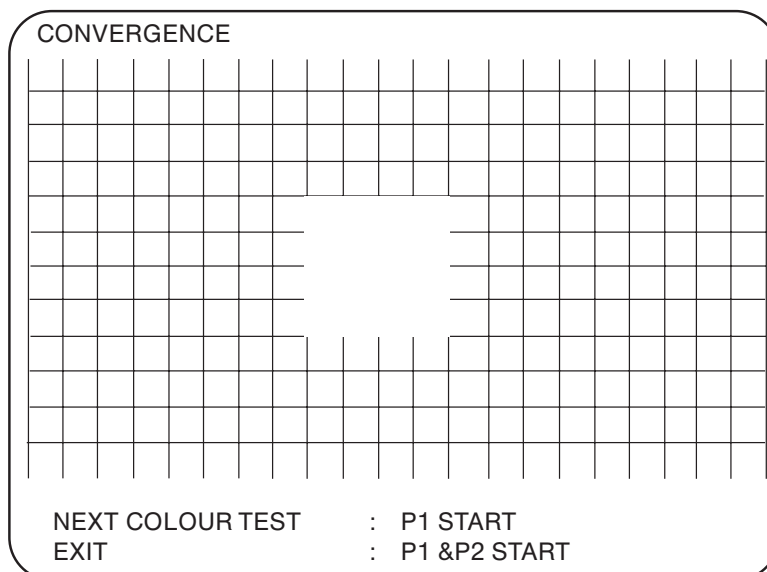

Sound Test

1. Select the option to be changed by pressing the Player 1 Start Button.
2. Press the Player 2 Start Button to activate the test.
3. Press Player 1 Start Button to select another option or select EXIT and press the Player 2 Start Button to return to the MENU screen.

SOUND TEST

SONG : [001] (a)

SOUND : OFF (b)

STATUS : 0000 (c)

LEFT RIGHT (d)

EXIT

SONG CHANGE : P2 START / P1 - TRIGGER

CHOOSE : P1 START

ENTER : P2 START

- (a) Each number will produce a different sound, for approximately 5 seconds, when the P2 Start Button is pressed. Song 001 will produce a Stereo Check. When Song Test is selected, pressing P2 Start button will increase the song number and pressing P1 Trigger will decrease the number.
- (b) OFF will change to ON will the sound is being played.
- (c) During Stereo Check (song 001) Left or Right will be displayed when sound is being produced from the left or right speaker.
- (d) Displays which speaker is producing sound in item (c)

Data Clear

1. Select the option to be changed by pressing the Player 1 Start Button.
2. Press the Player 2 Start Button to activate the reset.
3. Press Player 1 Start Button to select another option or select EXIT and press the Player 2 Start Button to return to the MENU screen.

Note: No changes will be stored unless EXIT & SAVE is selected from the MENU Screen.

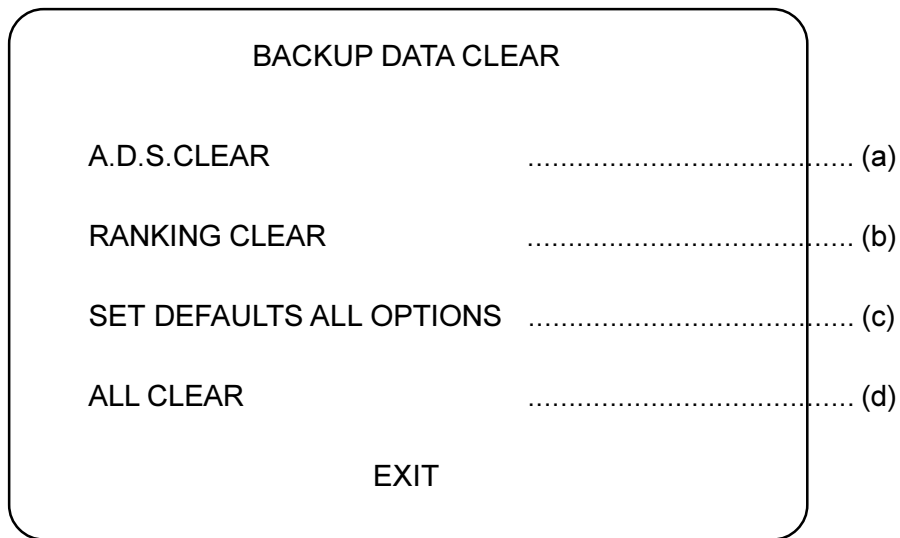

- (a) Resets all Game Play data.
- (b) Resets all Ranking data.
- (c) Resets all test options to factory preset.
- (d) Resets all items (a), (b), and (c) together.

Gun Initialize

This test MUST be carried out after replacing the Game PCB, ROMs, or Gun Assy. Failure to do so may cause incorrect game play.

1. Select GUN INITIALIZE from the test MENU screen. The following screen will be displayed.

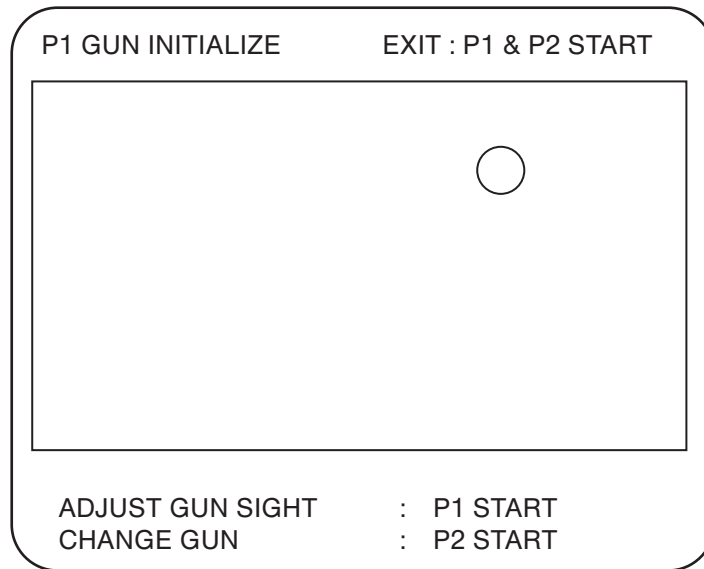

2. Aim and fire the gun. A ○ will appear on the screen. If the ○ appears where the gun was aimed, the gun sight is correct. If the ○ does not appear where the gun was aimed press P1 Start Button. The following screen will be displayed.

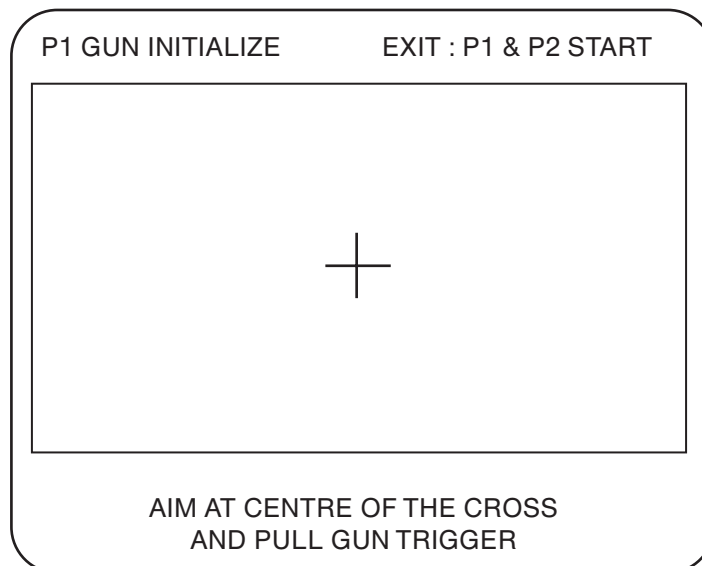

3. Aim the gun at the centre of the cross and pull the trigger. The gun sight is set and the display will return to the previous test screen.

Note: Ensure that the gun is level and not slanted when aiming at the centre of the cross otherwise the initialization may not be correct.

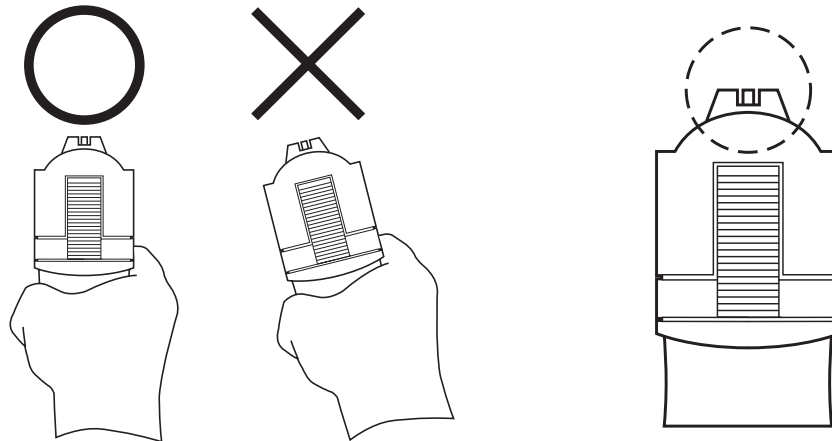

4. Repeat step 3 to confirm gun alignment.
5. Press P2 Start Button to switch from P1 Gun to P2 Gun.
6. Repeat steps 3 and 4 to initialize Gun 2.
7. Press P1 and P2 Start Switches together to return to the MENU screen.

Copies of Namco Game Manuals can be downloaded from our website:
www.namco.co.uk under Components Distribution

For all Parts or Technical Support contact:

Brent Spares,
Namco House,
Units 5-8, Acton Park Estate,
The Vale,
London. W3 7QE

www.namco.co.uk

For Technical Support, Warranty and

Advance Replacement Parts:-  +44 (0) 20 8324 6120

For Consumable Parts:-  +44 (0) 20 8324 6102

Fax for both:-  +44 (0) 20 8324 6126